

1

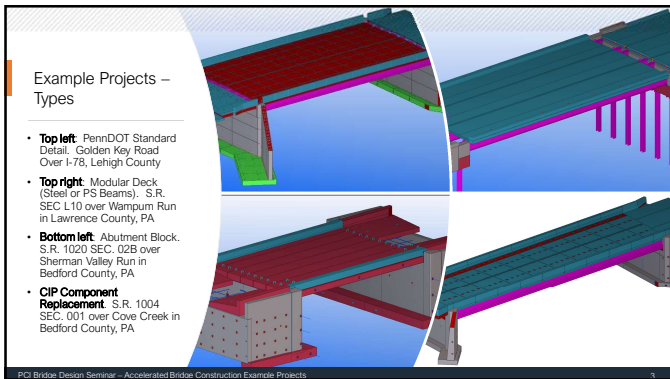

2



3

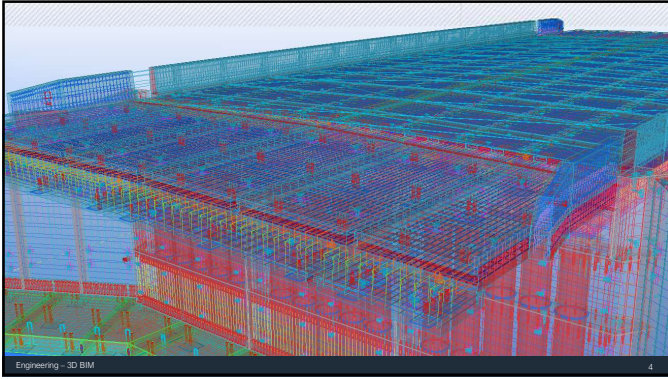

4

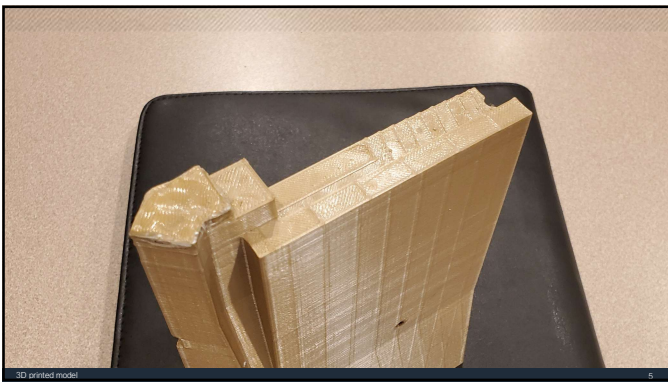

5

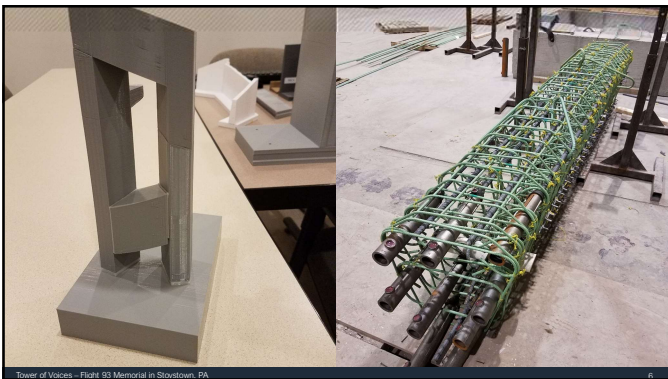

6

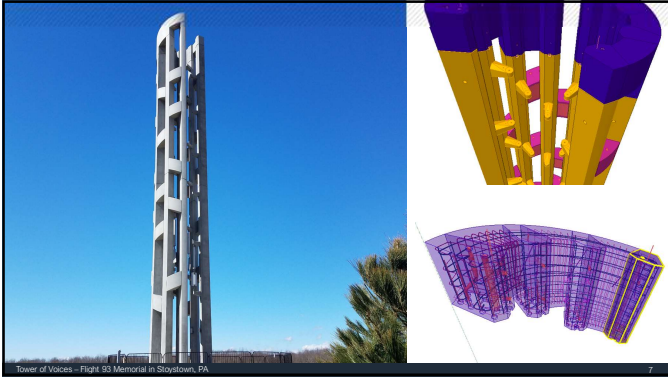

7



8



9

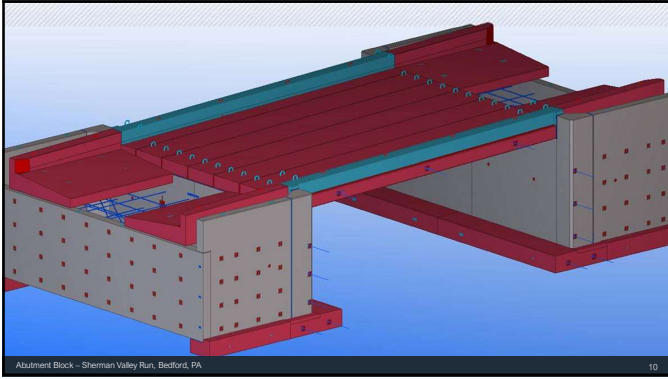

10

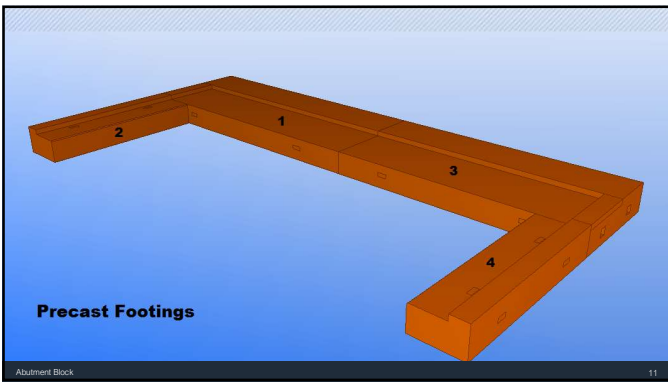

11

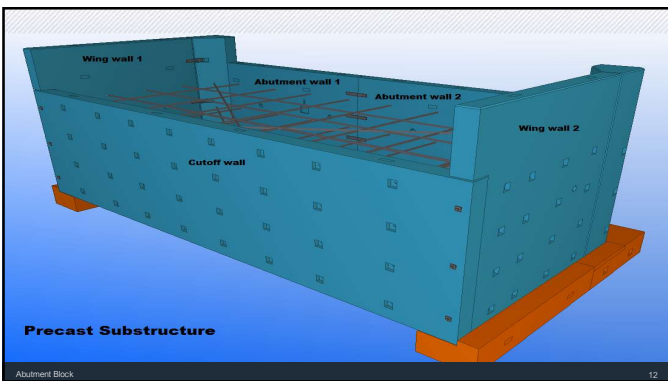

12

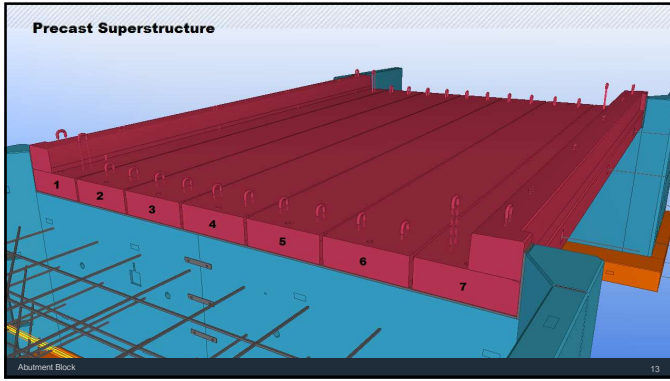

13

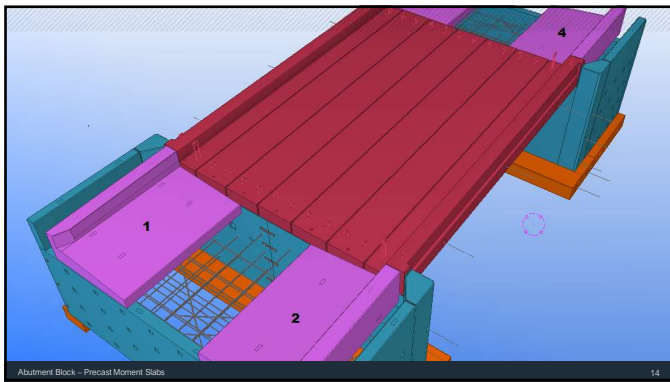

14

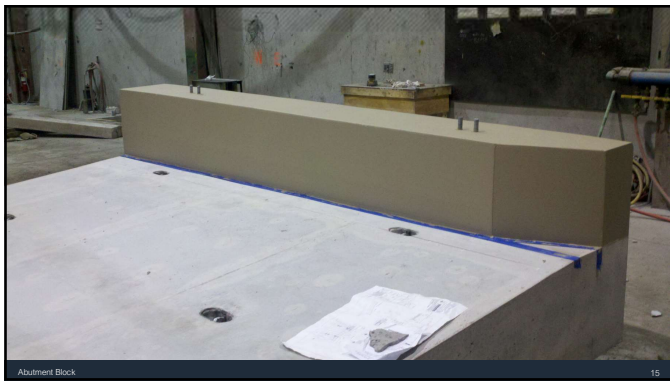

15



16

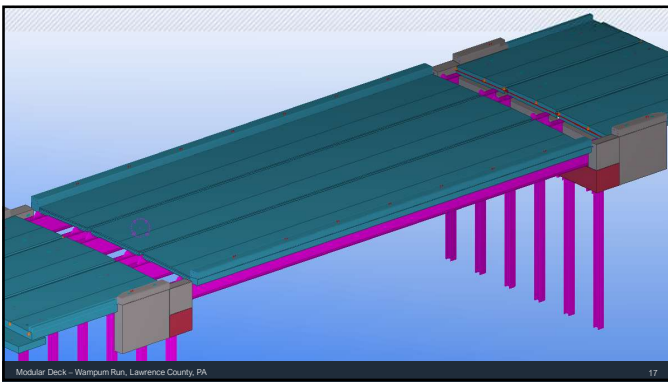

17

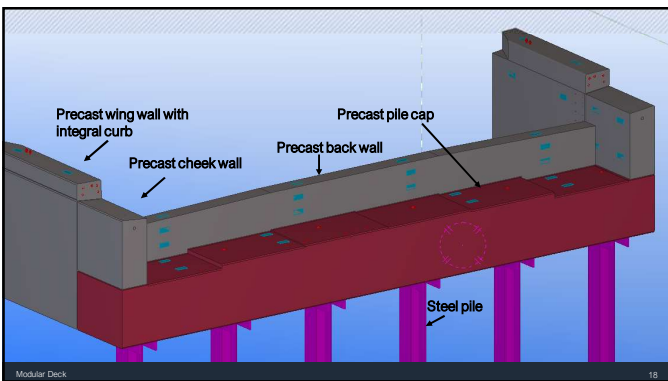

18

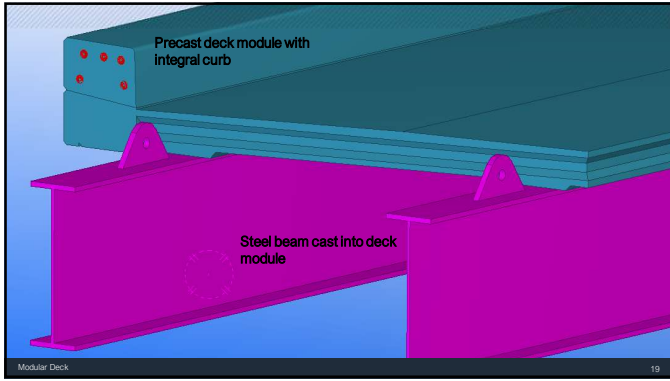

19

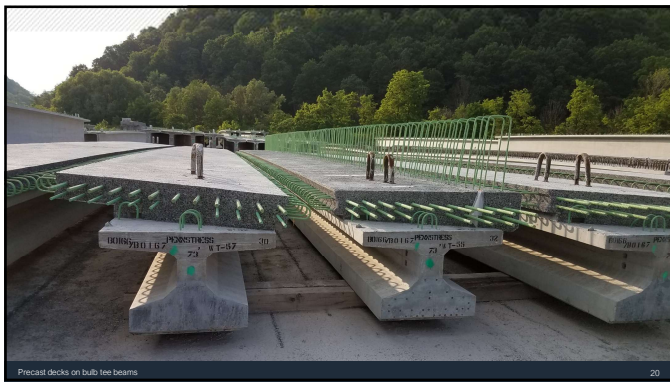

20

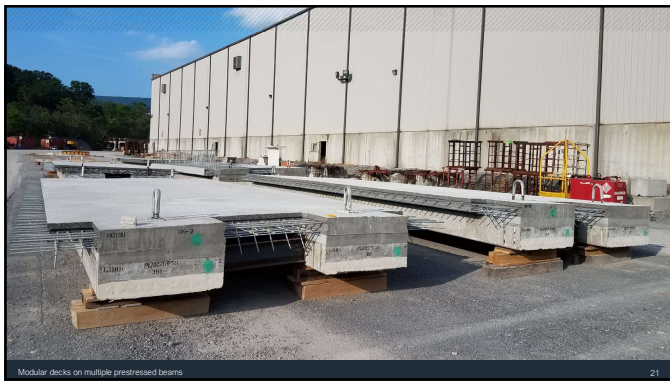

21



22

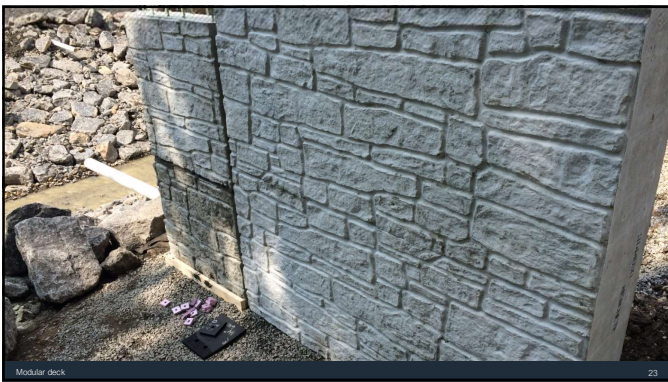

23



24

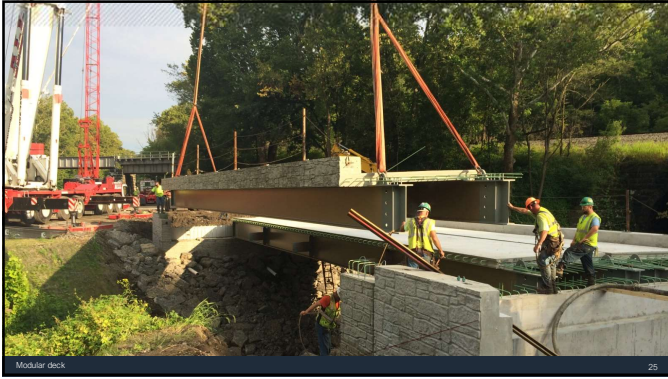

25



26

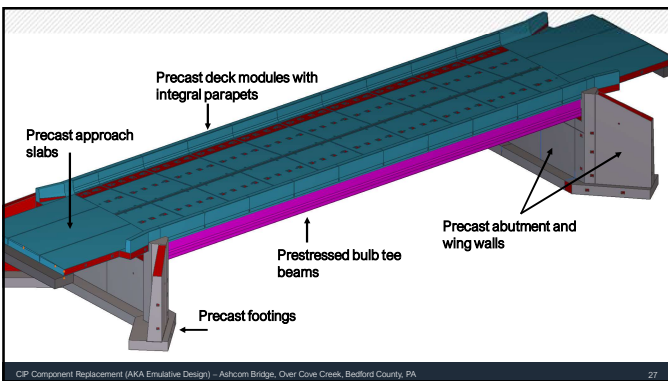

27

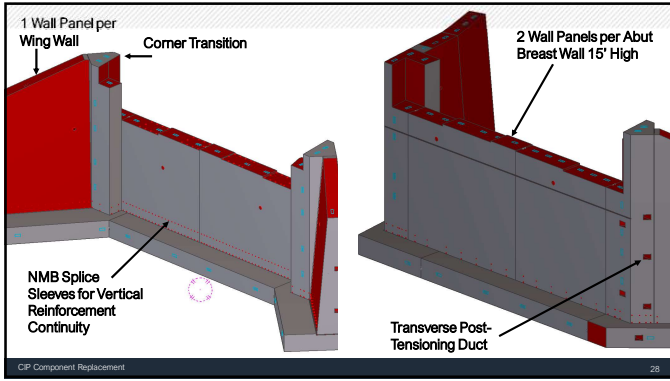

28



29



30



31



32



33



34

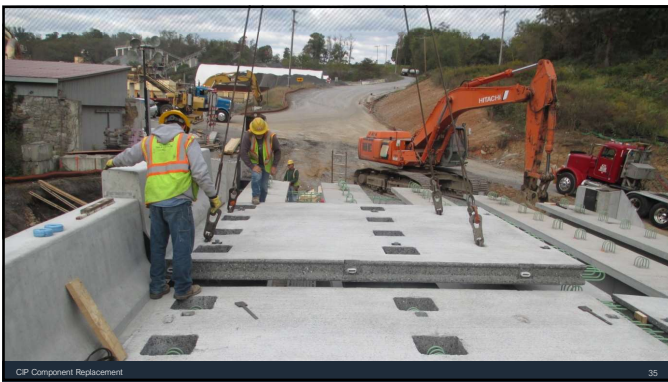

35

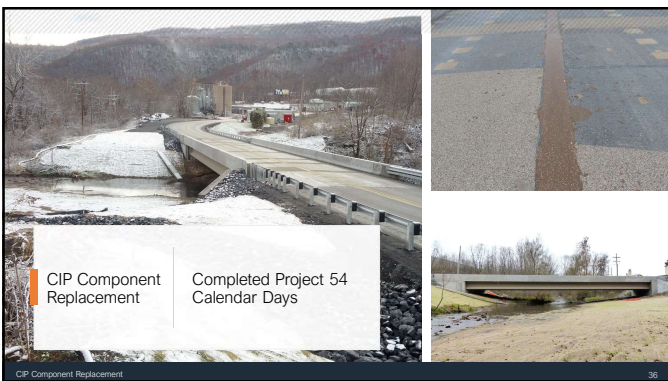

36

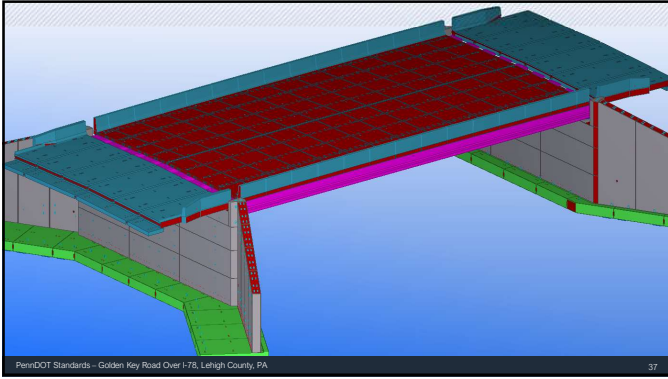

37

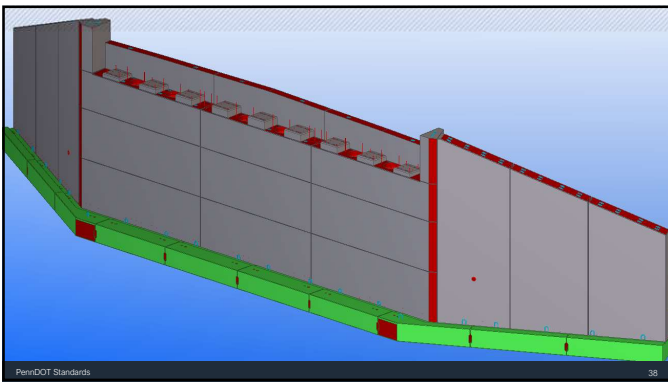

38

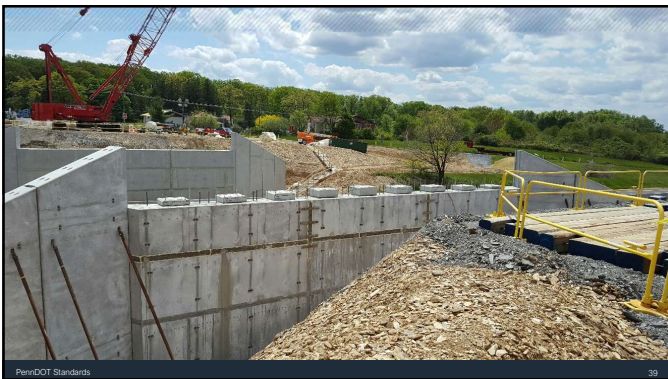

39

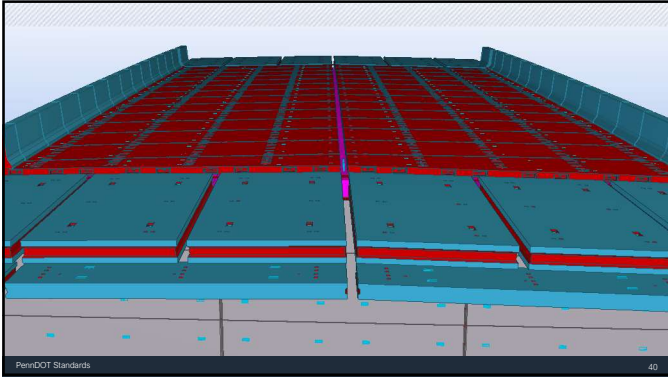

40

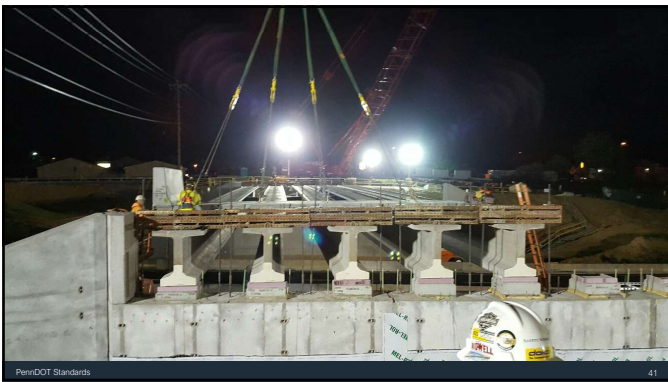

41



42



43



44



45

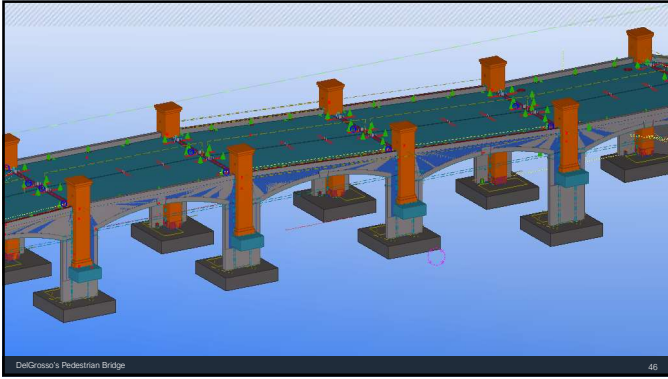

46



47



48



49



50

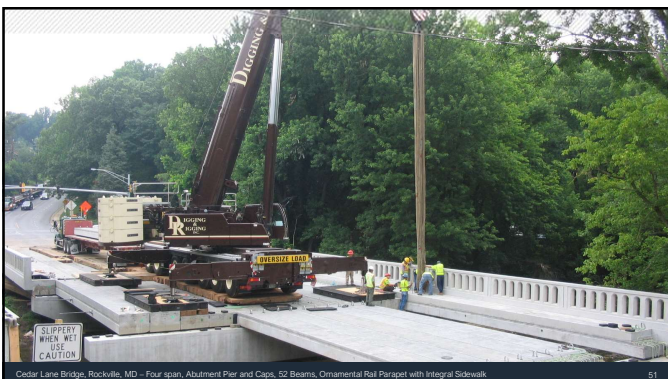

51

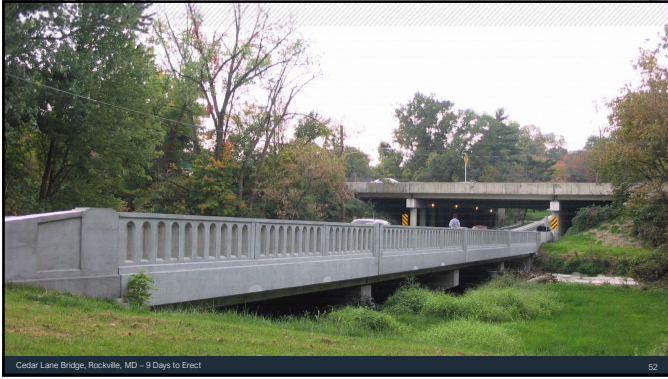

52

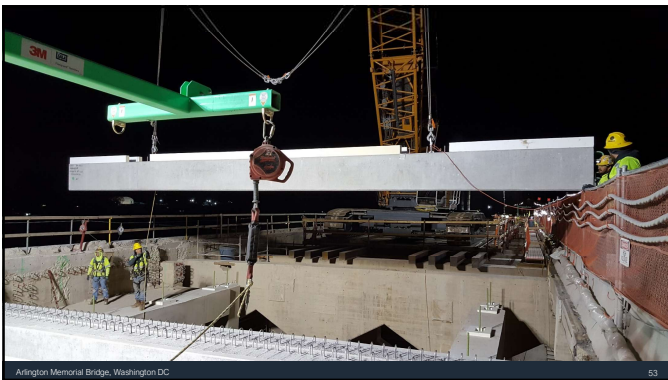

53

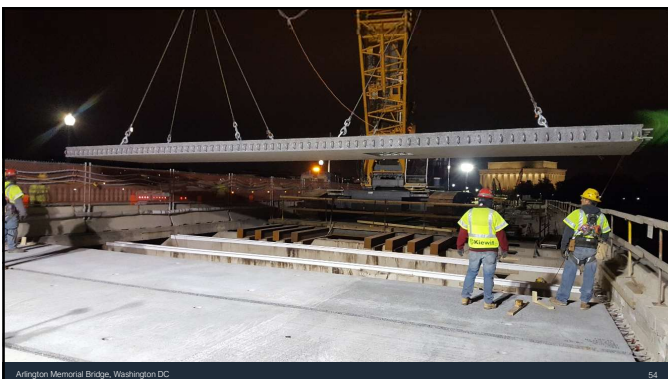

54

Summary – ABC Advantages

- Public and jobsite safety
- Speed – accelerated construction
- Quality
- Field operations
- Risk management
- Financial benefits and economics



Interstate 78 Bridge Under Clearance Project
Berks County, PA

Macro Beam Bridge Placement of the Herbert
C. Boren Bridge | Dare County, NC

Villanova University Pedestrian Bridge
Wayne, PA

PCI Bridge Design Seminar – Accelerated Bridge Construction Examples 55

55



56
