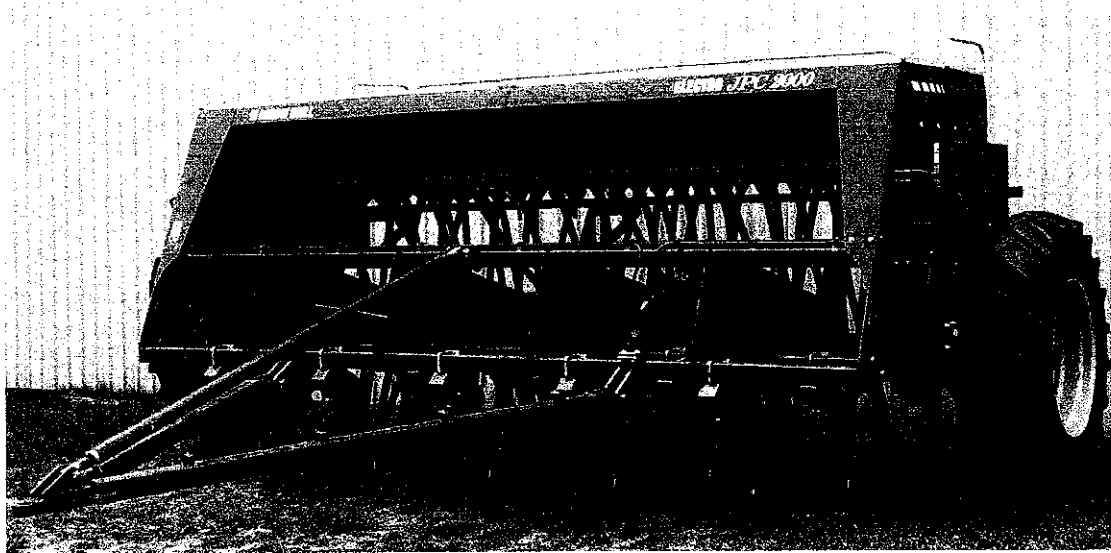




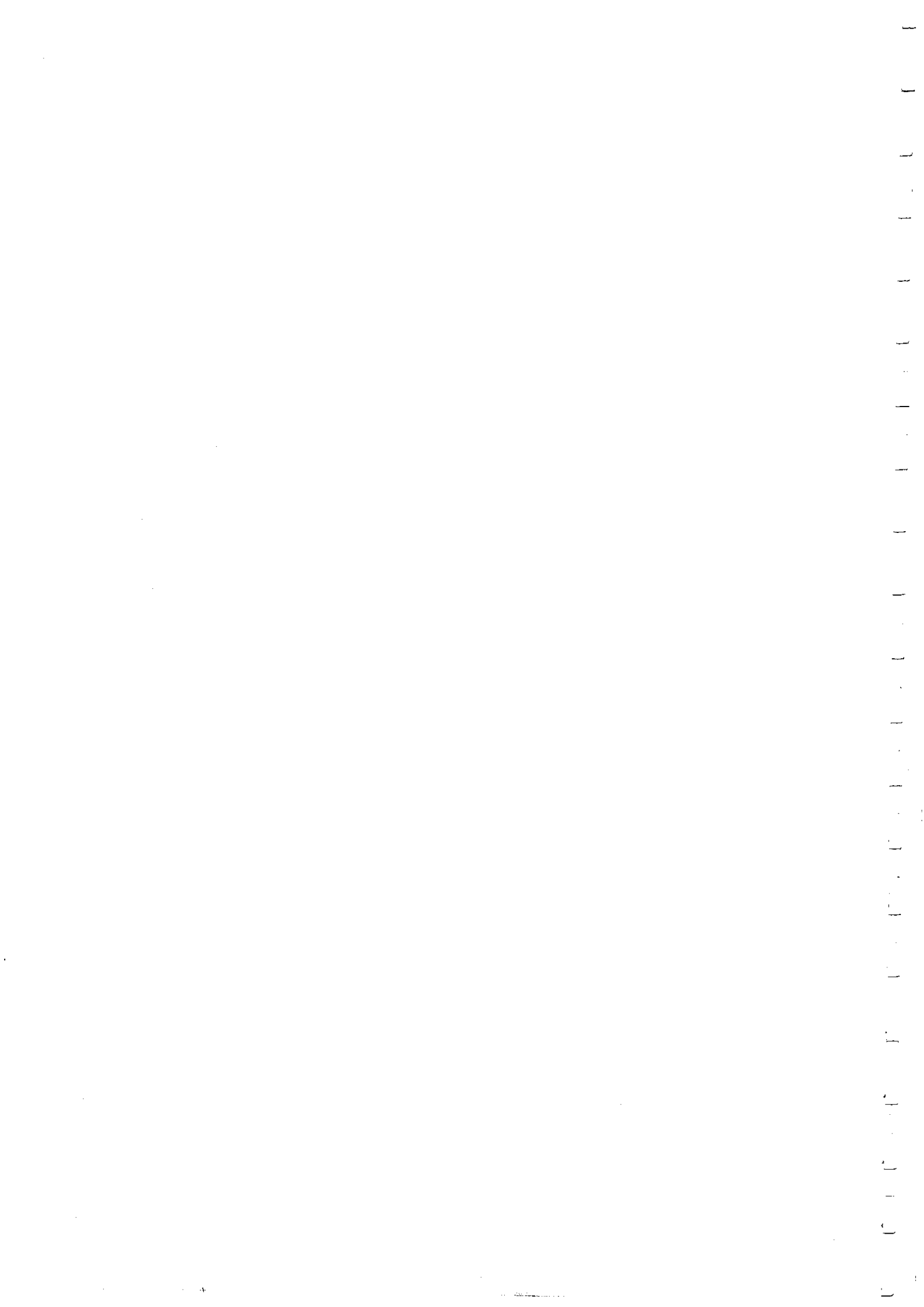
AGROWPLOW[®]

SOIL CARE SYSTEMS INTERNATIONAL PTY. LTD. A.B.N. 29 075 828 947



JPC 2000 Series Agrowdrill[®]

Operator's Manual





Agrowplow
Soil Care Systems International Pty Ltd
ABN 29 075 828 947

Contact Details

134 Thornton Street
WELLINGTON NSW 2820

PO Box 270
WELLINGTON NSW 2820

Phone: 02 6845 1566
FAX: 02 6845 1603

Email: agrowplow@agrowplow.com

Website: www.agrowplow.com

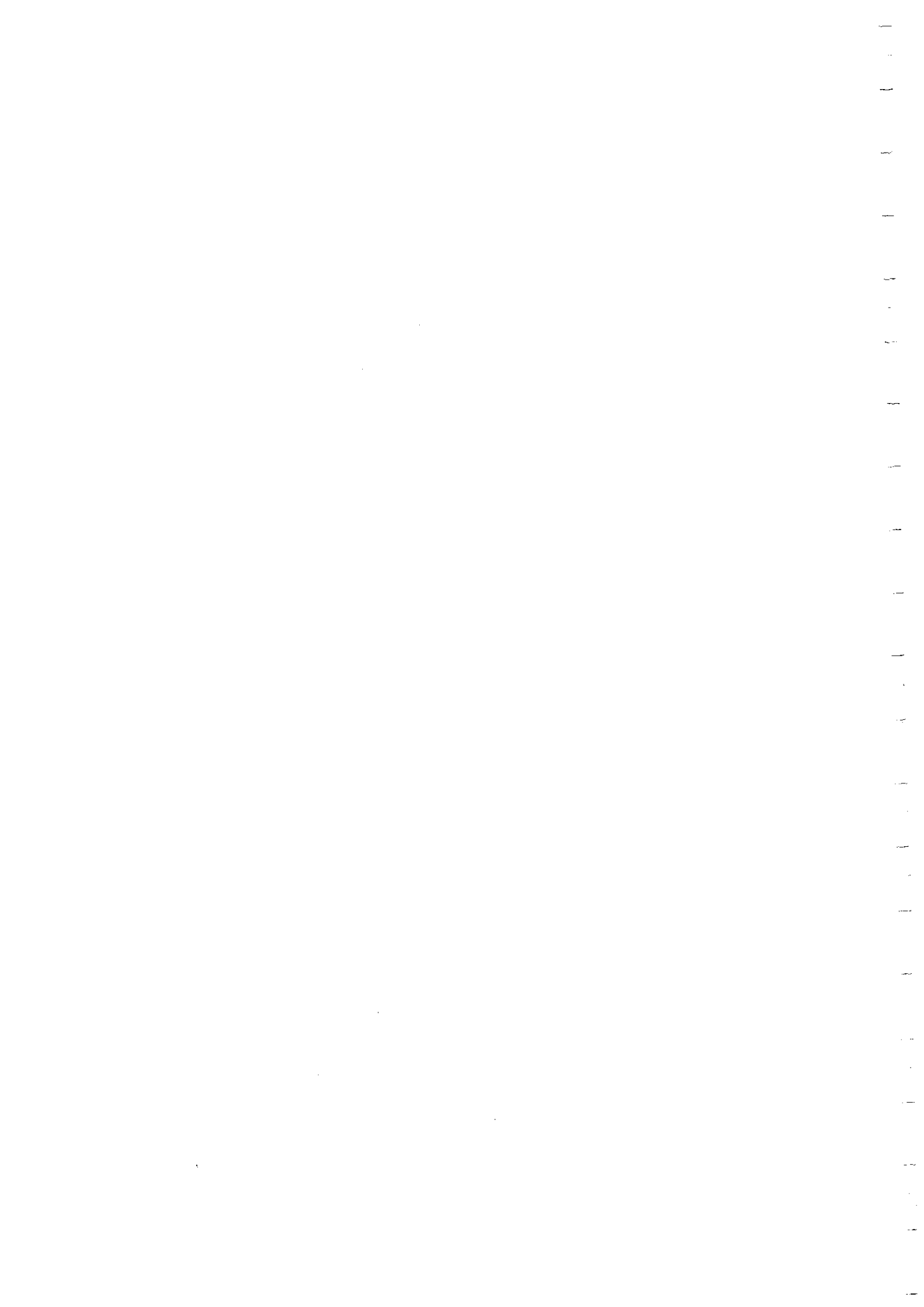


'Prosperity Through Soil Care'

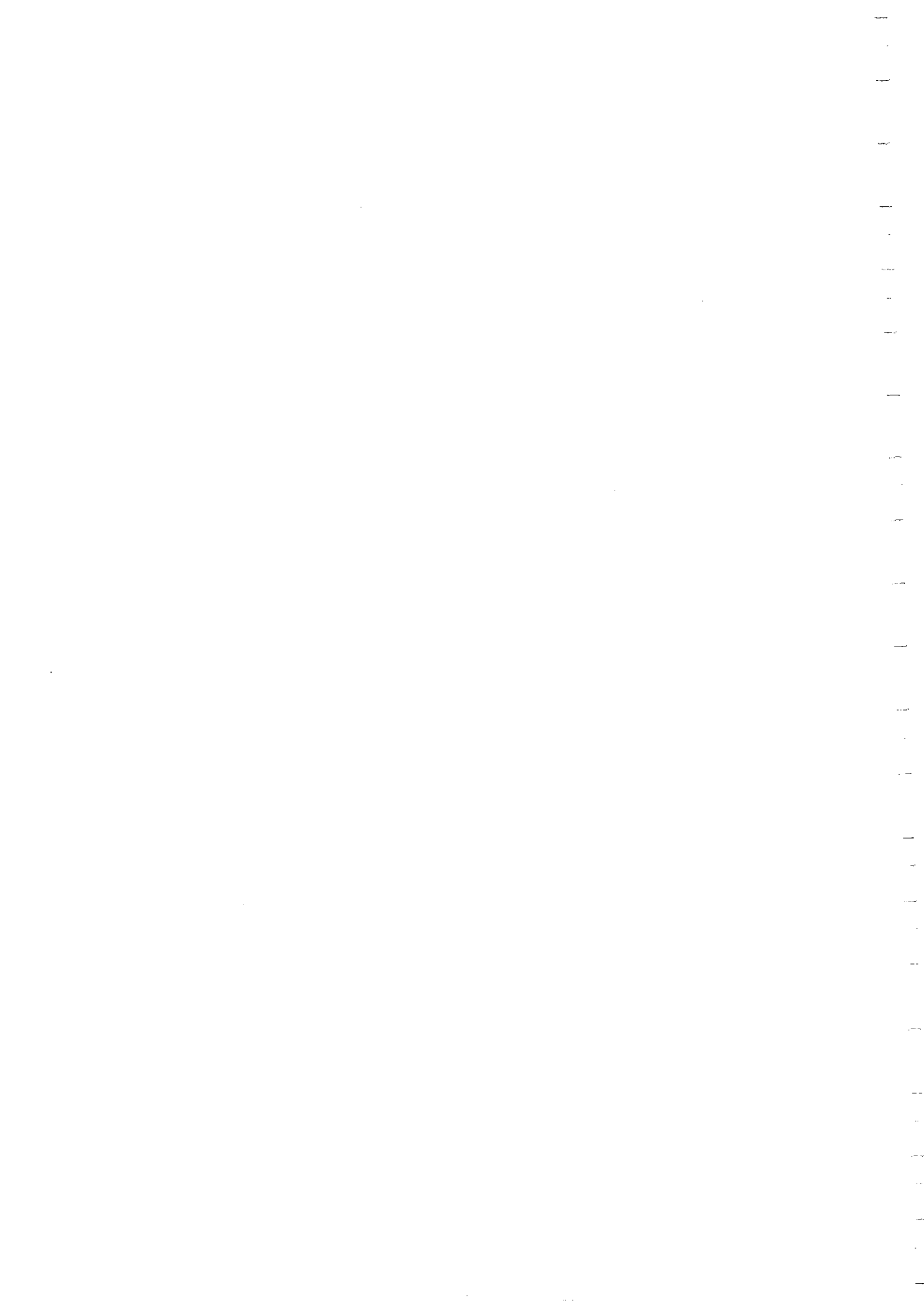


Table of Contents

1.0 Safety	1
1.1 Safety is the Operators responsibility	1
1.2 Safe Operation Needs a Qualified Operator	1
1.2.1 Understand the Instructions, Rules and Regulations	1
1.2.2 Have Training with Actual Operation	1
1.2.3 Know the Work Conditions	2
1.3 Safety Instructions	2
2.0 JPC 2000 Series Specifications	4
3.0 Principles of Direct Drilling	6
3.1 Weed Control.....	6
3.2 Timing.....	6
3.3 Seed	6
3.4 Seed Placement	7
3.5 Ensure Adequate Plant Nutrition	7
3.6 The Job's Not Finished at Seeding.....	8
3.6.1 Weed Control	8
3.6.2 Insect Pest Control.....	8
3.6.3 Use of Fertiliser	8
3.6.4 Grazing Management.....	9
4.0 Hectaremeter Installation	10
4.1 Installation Procedure	10
4.2 Hectaremeter Shaft Sensor Installation	11
5.0 Operating Instructions.....	13
5.1 Hitching and Levelling.....	13
5.1.1 Hitching	13
5.1.2 Hydraulic Lift Circuit	13
5.1.3 Levelling.....	15
5.2 Tyre Pressures	15
5.3 Seeding Depth.....	15
5.4 Row Spacing	16
5.5 Operating Speed.....	16
5.6 Hopper Selection	16



6.0 Calibration Instructions	17
6.1 Farmscan 1100 Hectaremeter.....	17
6.2 Operation of the Hectaremeter.....	17
6.3 Calibrating the Hectaremeter.....	18
6.4 Metering Rates.....	19
6.5 Method for Checking Metering Rates.....	19
6.5.1 Calibration Procedure.....	20
6.6 Field Calibration.....	21
6.7 Plotting Calibration Charts.....	22
6.8 Adjusting the Seed and Fertiliser Rates.....	22
6.8.1 Gearbox Adjustments.....	22
6.8.2 Restrictors.....	23
6.8.3 Gate Settings.....	24
6.9 Calibration Charts.....	24
6.10 Agrowdrill Calibration Settings.....	32
7.0 Operating Tips	33
7.1 After the First Round.....	33
7.2 Gradual Slowing of Fertiliser Flow.....	33
7.3 Seizing of the Metering System.....	33
7.4 Checking the Rotation of the Drives.....	34
7.5 Cleaning Seed and Fertiliser Hoppers.....	34
8.0 Lubrication and Maintenance	35
8.1 Pre-Operation Check.....	35
8.2 Daily Service.....	35
8.3 Lubrication.....	35
8.4 Replacing Soil Openers.....	36
8.5 Downtube Assembly.....	36
8.6 Replacing Adjustable Gates.....	37
8.7 Servicing Fluted Rollers.....	37
8.7.1 Drive Sprocket Bearings.....	37
8.7.2 Fluted Rollers.....	37
8.7.3 Drive Shaft Mounting Bushes.....	38
8.8 Major Servicing of the Metering Mechanism.....	38
8.9 Servicing the Gearboxes.....	39
8.10 Drive Chain Adjustments.....	39
8.11 Drive Chain Maintenance.....	40
8.12 Hectaremeter Sensor and Cable.....	40
8.13 Hectaremeter Multimeter Test.....	40
8.13.1 Reed Type Sensor.....	40
8.13.2 Sensor Cable.....	41
8.14 End of Season Storage.....	41
9.0 Trouble Shooting	42
9.1 Underframe.....	42
9.2 Metering System.....	44
9.3 Hydraulics.....	46
9.4 Hectaremeter.....	47



1.0 Safety

1.1 Safety is the Operators Responsibility

The Agrowdrill is a robust and versatile direct drill capable of operating under a wide variety of conditions. It can be used for direct drilling applications as well as traditional cultivation and seeding to maximise seed germination and plant establishment for pastures, summer crops, cereals, oil seeds and legumes.

The Agrowdrill presents an operator with hazards associated with setting up, on and off road transport, tillage and seeding applications, as well as machine service and maintenance. The operator must be aware of these hazards.

The dealer will explain the capabilities, safe application, service requirements and restrictions of the Agrowdrill and demonstrate the safe operation of the Agrowdrill according to Soil Care Systems International instructions. The dealer can also identify unsafe modifications or use of unapproved attachments.

The following publications provide information on the safe use and maintenance of the Agrowdrill and attachments:

- The operator's manual delivered with the Agrowdrill gives operating information as well as routine maintenance and service procedures. It is a part of the Agrowdrill and must stay with the machine if it is sold. Replacement operator's manuals can be ordered from your Agrowplow Dealer.
- The Agrowdrill has machine decals that instruct on safe operation and care.

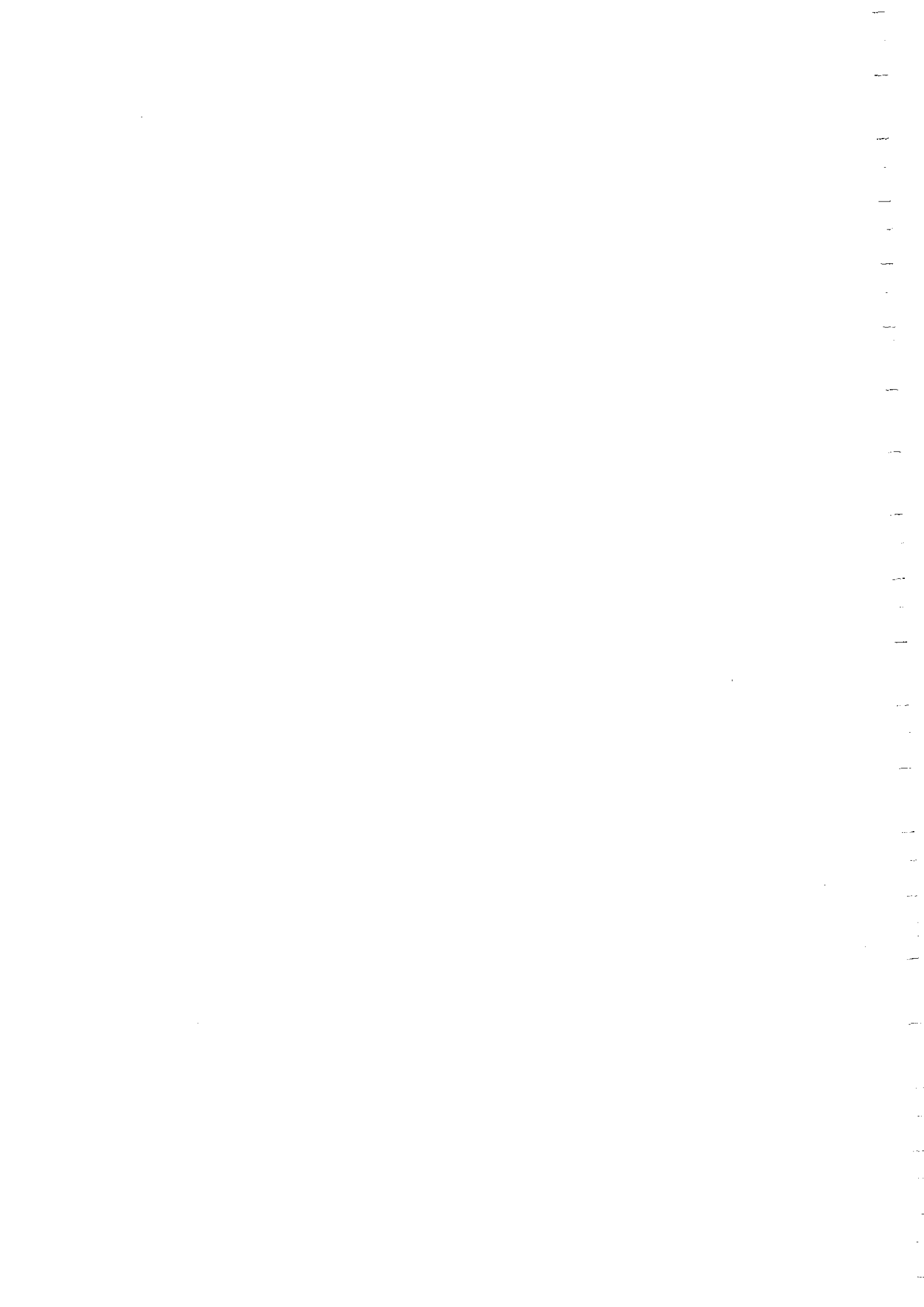
1.2 Safe Operation Needs a Qualified Operator

1.2.1 Understand the Instructions, Rules and Regulations

- The written instructions for the operation of the Agrowdrill are included in the Agrowdrill operator's manual and on the machine decals.
- Check the rules and regulations for your location. These rules may include any Federal and State safety requirements.

1.2.2 Have Training with Actual Operation

- Operator training must consist of a demonstration and verbal instruction. This training is given by your dealer when the Agrowdrill is delivered.



- New operators must start in an area without bystanders and use all the controls until they can operate the Agrowdrill safely under all conditions of the work area.

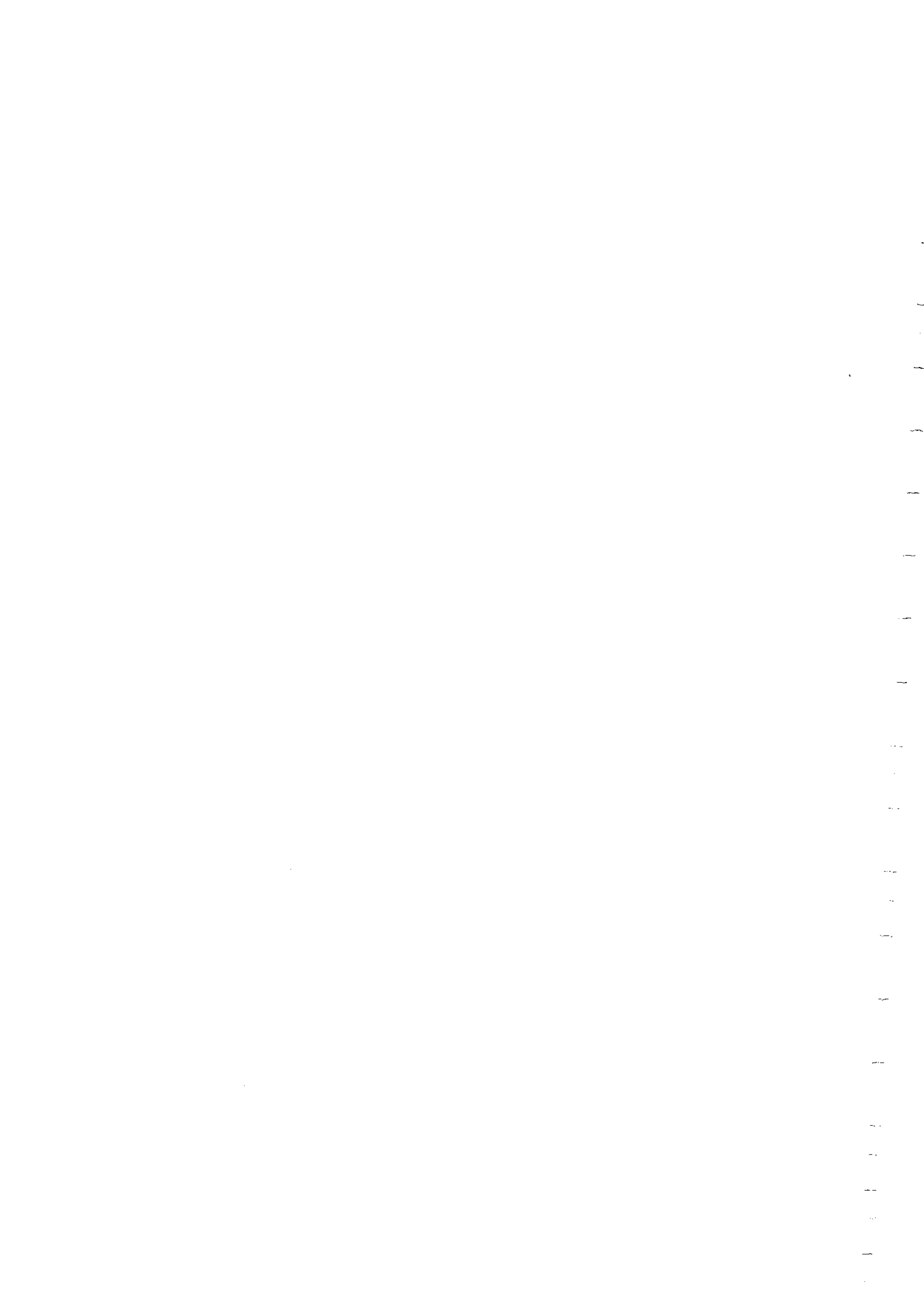
1.2.3 Know the Work Conditions

- Operators must know any prohibited uses or work areas. They need to know about excessive slopes and rough terrain.
- Operators must know the local road transport regulations, and understand the dangers and requirements of transporting wide and heavy equipment.
- Always wear protective clothing when maintaining or servicing the Agrowdrill.
- For operators to be qualified, they must not use drugs or alcoholic drinks that impair their alertness or coordination while working. Operators who are taking prescription drugs must get medical advice to determine if they can safely operate a machine.

1.3 Safety Instructions

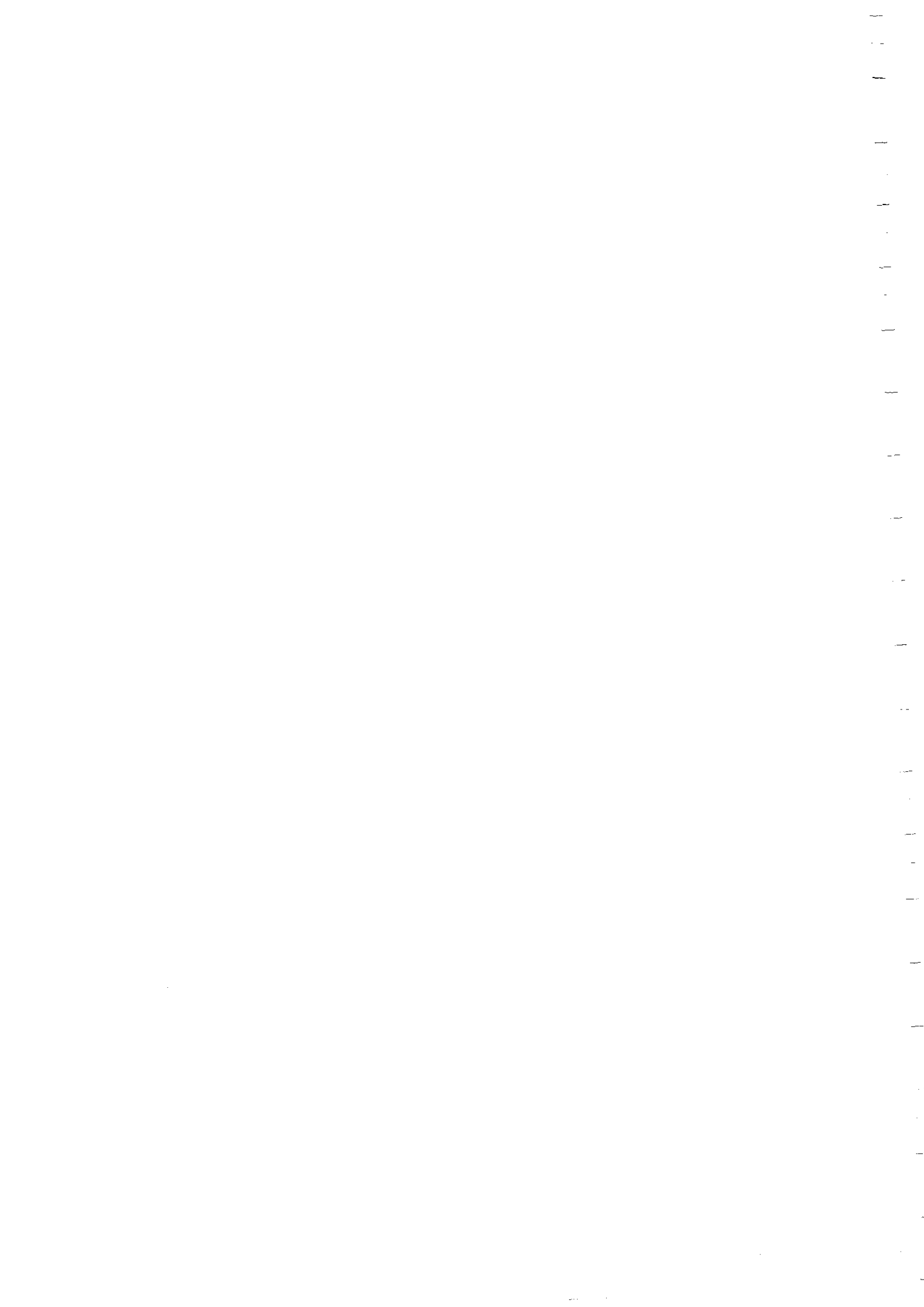
READ THESE SAFETY INSTRUCTIONS CAREFULLY BEFORE ALLOWING ANY PERSON TO OPERATE THE AGROWDRILL

1. Review this manual before each season of use.
2. Never allow anyone unfamiliar or untrained to operate the implement.
3. Operators must know and abide by any road transport regulations pertinent to the transit of your Agrowdrill.
4. Never leave the Agrowdrill in a raised position. Accidental release of control levers or hydraulic hose failure will result in the machine dropping. This can cause serious injury to someone near or under the implement.
5. Do not transport the Agrowdrill without the tractor drawbar being in a locked position. Transporting without the drawbar locked will result in loss of implement control and serious damage or injury.
6. Do not transport an Agrowdrill in excess of 20 kph. Transporting at greater speeds will result in loss of implement control and cause serious damage or injury.
7. Do not transport an Agrowdrill with a vehicle of less gross mass than that of the Agrowdrill being towed. Transporting with a smaller lead vehicle will result in loss of implement control and cause serious damage or injury.
8. Do not pull the Agrowdrill from any point other than from the tractor drawbar. Pulling from a point other than the designated tractor drawbar can result in tractor instability and cause serious damage or injury.
9. Extreme caution should be used when clearing coulters, tynes or soil openers. These may be very sharp and cause serious injury.
10. Do not ride on an Agrowdrill at any time.



11. Use due care when adjusting or maintaining any aspect of the Agrowdrill. Failure to do so may result in serious injury.
12. When undertaking maintenance on the Agrowdrill the operator must ensure that the tractor is turned off and the hydraulics are fully lowered. Accidental release of control levers or hydraulic hose failure will cause the implement to drop down. This can cause serious injury to someone near or under the machine.
13. If the Agrowdrill must be in a raised position for service or maintenance, ensure the unit is securely supported with proper support stands or the cylinder stoppers supplied with your Agrowdrill. After the implement is secured release the hydraulics on to the supports and stop the tractor engine before starting work. If supports are not used accidental release of control levers or hydraulic hose failure will cause the implement to drop down. This can cause serious injury to someone near or under the machine.
14. Do not remove any safety instruction decals.
15. Ensure that any safety decals are clear and visible. Clean and replace as necessary.





2.0 JPC 2000 Series Specifications

Model		20R	24R	28R	32R
Frame Width		3.6m	4.2m	5.1m	5.7m
Box 1 & 4	Each	527 litres	612 litres	741 litres	827 litres
Box 2 & 3		479 litres	558 litres	675 litres	753 litres
Number of Toolbars		5			
Toolbar Spacing		0.5m			
Underframe Clearance		0.67m with 732 Coil Tyre			
Maximum Number of Sowing Rows		24	28	34	38
Drawbar Power Required	kW	65 – 75	70 – 90	85 – 105	100 – 140
	HP	85 - 100	90 - 120	115 - 140	130 – 190
Wheel Equipment		18.4 x 34 Lugged Tyre			
Wheel Centres		4.6m	5.2m	6.0m	6.7m
Transport & Shipping					
Width		5.01m	5.6m	6.5m	7.1m
Height		2.34m			
Length		3.04m			
Unladen Mass		3000kg	3400kg	3800kg	4200kg

Depth Control Hydraulic rephasing cylinders with manual depth adjustment.

Main Frame 5 bar standard 100 x 100 x 6mm High Tensile RHS with 350 grade end walls and centre supports.

Trailed Hitch A-frame is a rigid construction made from High Tensile 100 x 100 x 6mm RHS with heavy duty levelling tube assembly.

Hopper Construction of 2mm and 5mm HRC to resist corrosion.



Metering Mechanism 2 Large 70mm diameter dual row fluted rollers (fine and course seed) per outlet. Made from glass filled nylon and finished to a non-stick, low friction surface.

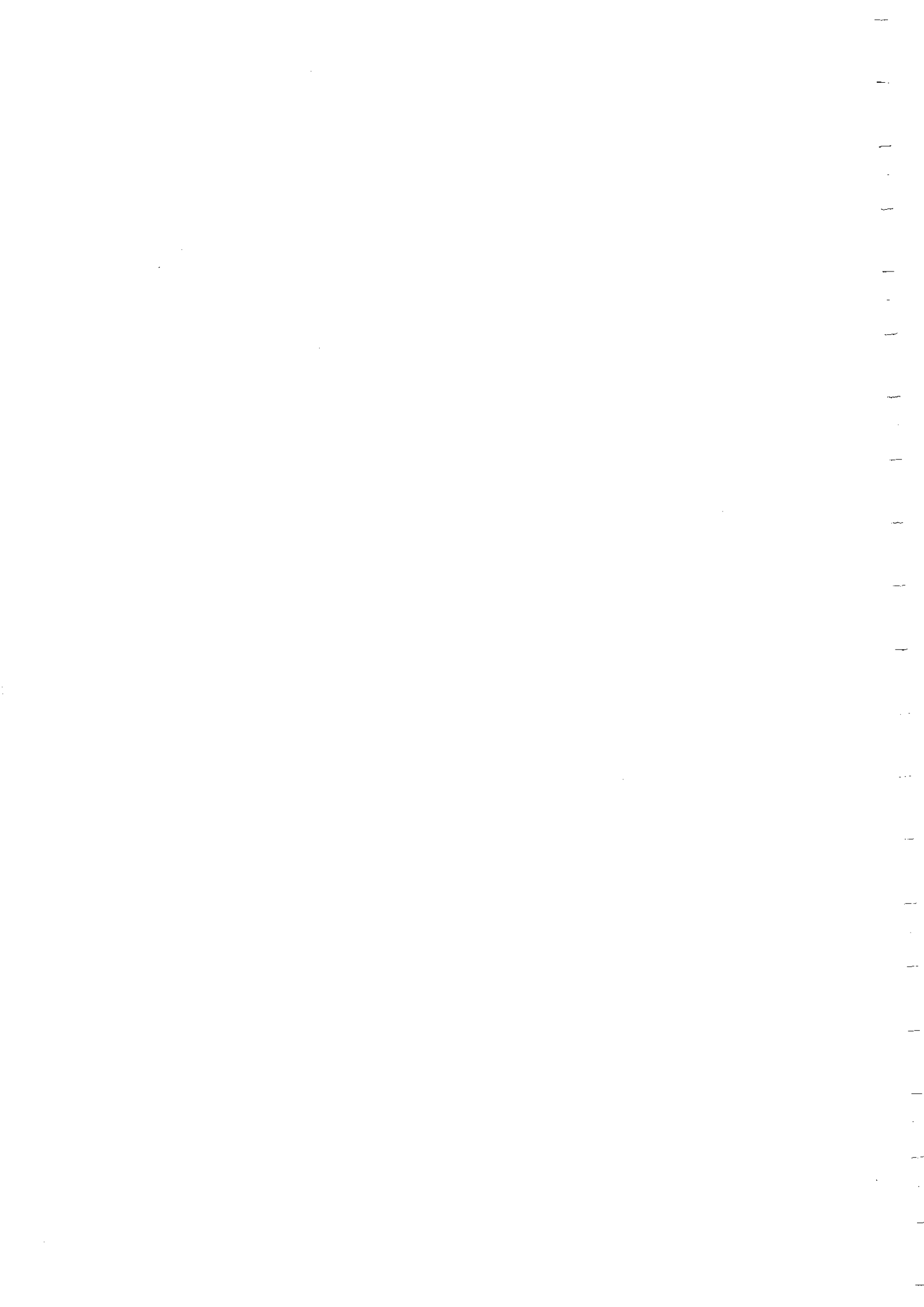
Transmission Single lever control for each hopper compartment. Fully enclosed transmission housing. Infinite speed variation from zero to maximum rates. Single lever control of gate settings giving infinite variation of gate clearance under distributors allowing easy adjustment for varying seed sizes.

Optional Equipment

- Standard Coil Tyne
- 700 Series Coil Tyne
- 732 Series Coil Tyne
- Extension Stubs
- Front or Rear Platform
- Single and Double Outlet Feed Cups
- 2nd and 3rd Seeding Tubes
- Fabricated or Cast Sowing Boots
- Internal Lid Assemblies
- Fertiliser Screens
- Baffles
- Rear Seed Tube Rack
- Rear Hitch with Hydraulic Couplings



Figure 2.1: JPC 2000 Series Agrowdrill



3.0 Principles of Direct Drilling

3.1 Weed Control

Good weed control is essential for successful establishment of a new crop or pasture.

Weed control is one of the main reasons for traditional cultivation practices - the ground-engaging tool physically cuts and tears the roots of unwanted plants from the soil.

Direct drilling calls for a different approach. Some of the alternatives available for weed control include:

- Heavy grazing
- Spraying with herbicides
- Slashing
- A combination of the above

3.2 Timing

Timeliness of the seeding operation is critical for good germination, growth and best yield results.

There are two main aspects of timeliness you must consider:

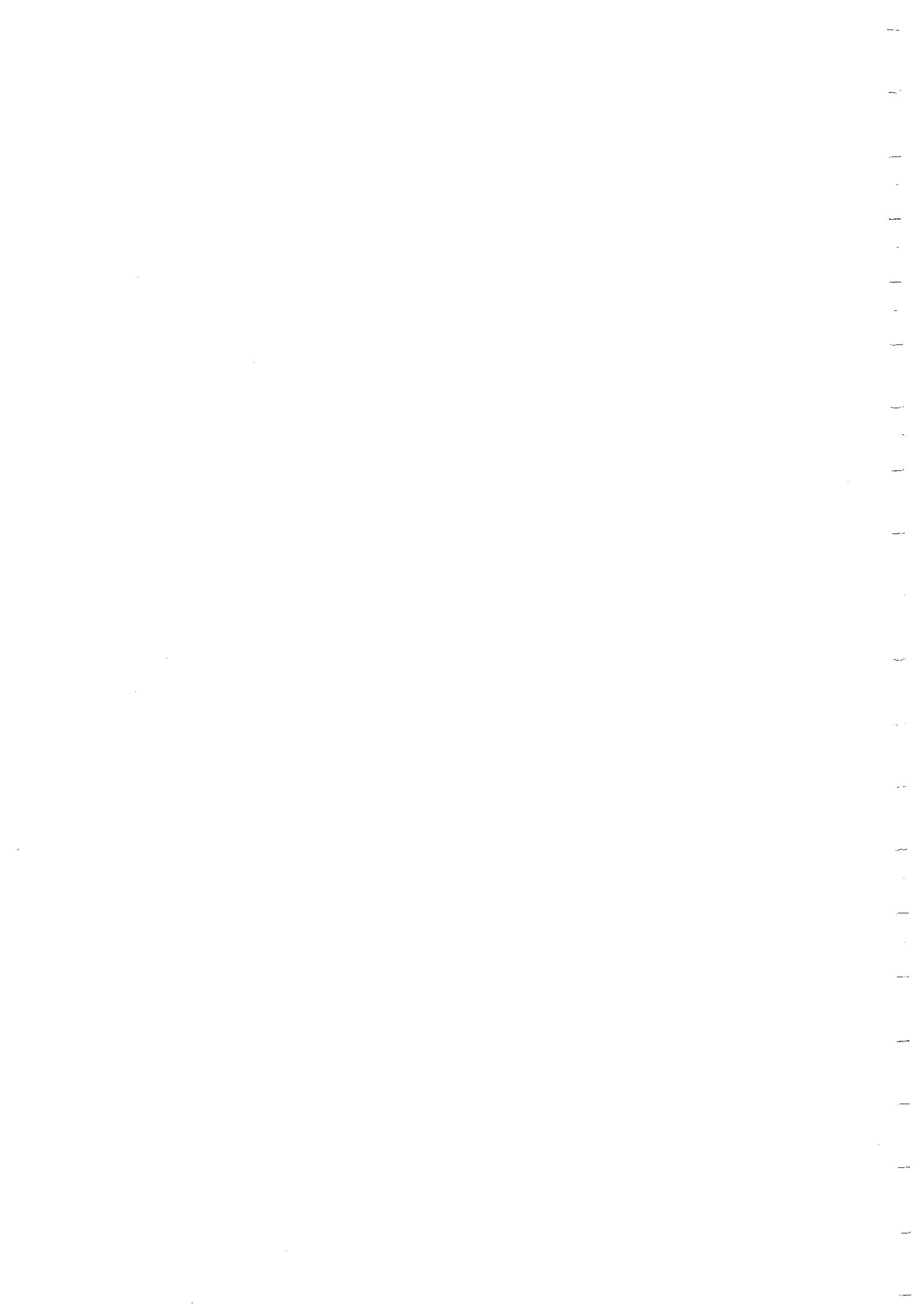
- Always check the optimum seeding date for your district and seed on time.
- Ensure the best use of available moisture after rain by seeding while the soil is moist.

3.3 Seed

Use only good quality certified seed. Certified seed is guaranteed to meet a minimum standard germination percentage and to be free of weed seeds and impurities. Use the recommended seeding rate.

Your seed supplier or your local advisory officer can tell you how many kilograms per hectare (kg/Ha) you should sow. Adequate plant population will also help your establishing crop or pasture compete with weeds.

Be sure to inoculate legume seed with the correct strain of Rhizobia bacteria. Failure to inoculate could lead to a poor pasture stand. Talk to your seed supplier about inoculation and ask them to supply the inoculant.



Your seed supplier will also be able to advise about chemical protection of your seed for insect attack and various soil borne diseases.

3.4 Seed Placement

Accurate seed placement is crucial for successful germination. Seed should always be covered and in contact with moist soil (see figure 3.1). Seeding depth varies with species and is generally related to seed size.

Small seeds generally need to be placed shallow. The Agrowdrill is capable of placing seed accurately at any depth from a few millimetres down to 75mm (3"). Ask your seed supplier or advisory officer how deep you should be sowing and adjust the Agrowdrill accordingly.

The Agrowdrill can be set up to seed at various row spacings. Sowing row spacing, if coulters are not fitted, can be virtually infinite.

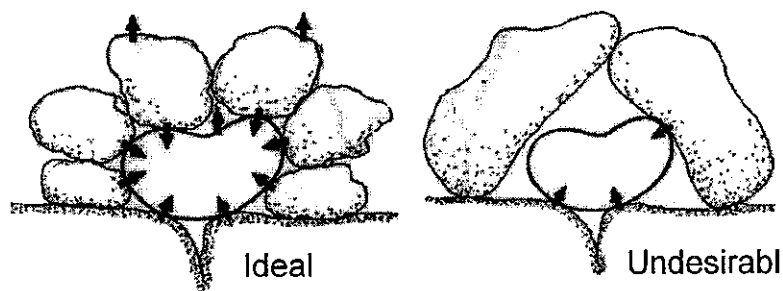


Figure 3.1: Seed to soil contact.

3.5 Ensure Adequate Plant Nutrition

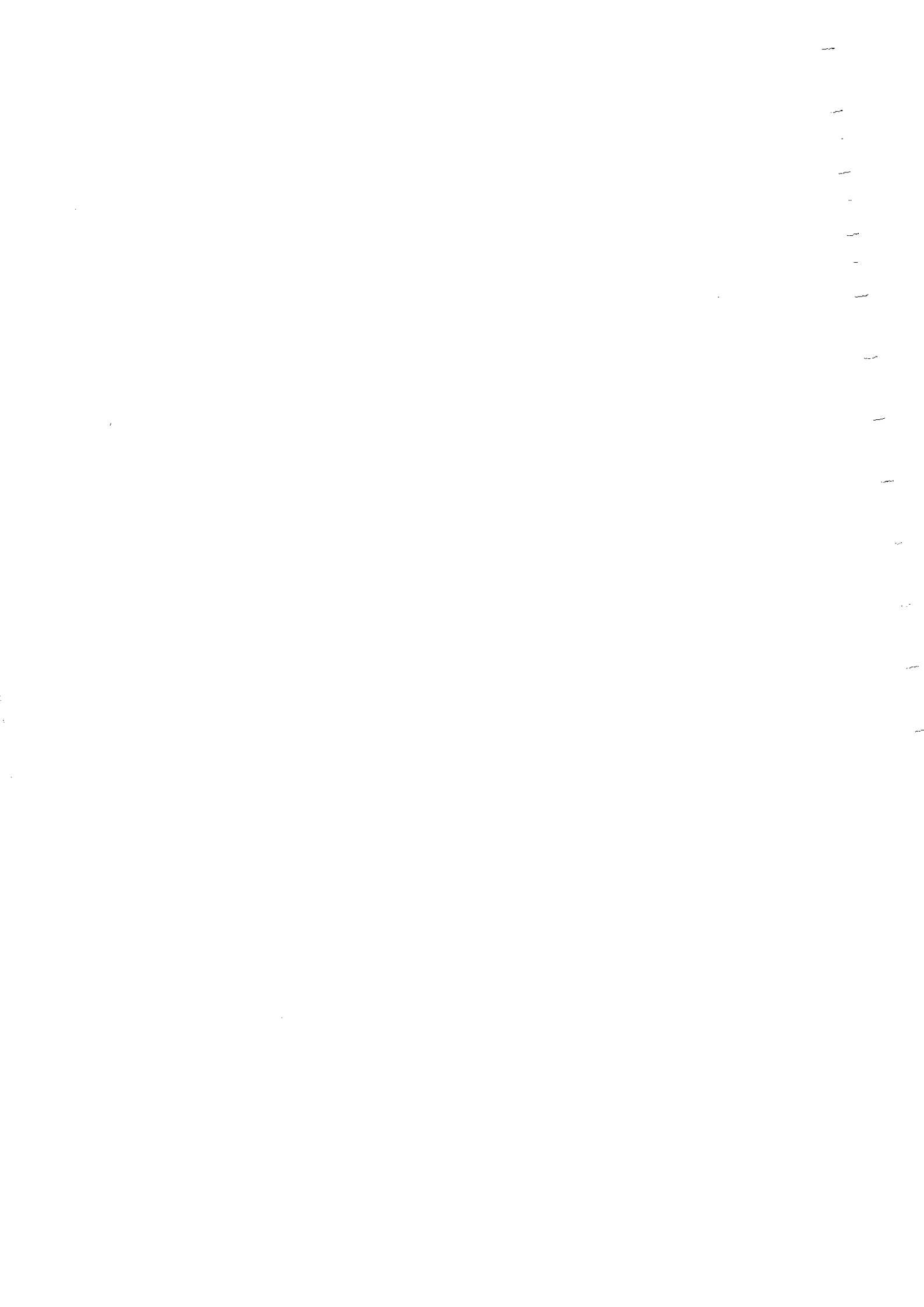
Most Australian soils are low in fertility and need to have nutrients added to boost pasture and crop growth. Young plants especially need good nutrition.

The need for fertiliser can be assessed in a number of ways:

- Paddock history.
- The vigour of existing vegetation.
- Chemical soil tests.
- Trial plots.

Advice on fertiliser requirements can be sought from government advisory officers, agricultural consultants or fertiliser companies.

Fertilisers are available in many different forms and can be applied in many different ways. The Agrowdrill can "band" artificial fertilisers close to the seed and provide nutrition where it is most need.



3.6 The Job's Not Finished at Seeding!

Careful preparation and seeding of a crop or pasture are only the first steps in the management process. There is a great deal of careful management practises needed after the Agrowdrill has given your seed the best chance of establishment.

3.6.1 Weed control

Effective weed control can be the difference between a profit and disaster. Good weed control before seeding will ensure emerging seedlings have a good start and an even better finish.

Certified seed, adequate fertility, correct seeding rates and placement of seed will put the odds in your favour for good germination and emergence.

The management practices after emergence however are just as important. Inspect your crop or pasture regularly for weed growth. If weeds become a problem you have a number of options open to you:

- Use a selective herbicide to kill weeds.
- Strategic grazing or slashing can help reduce weed growth.
- Applying fertiliser may help in some situations.
- Cutting hay can remove weeds.

3.6.2 Insect Pest Control

Insect pests can seriously damage emerging or established crops and pastures. During your regular inspection you should also be on the lookout for insects. Consideration of the following points will help prevent or eliminate insects:

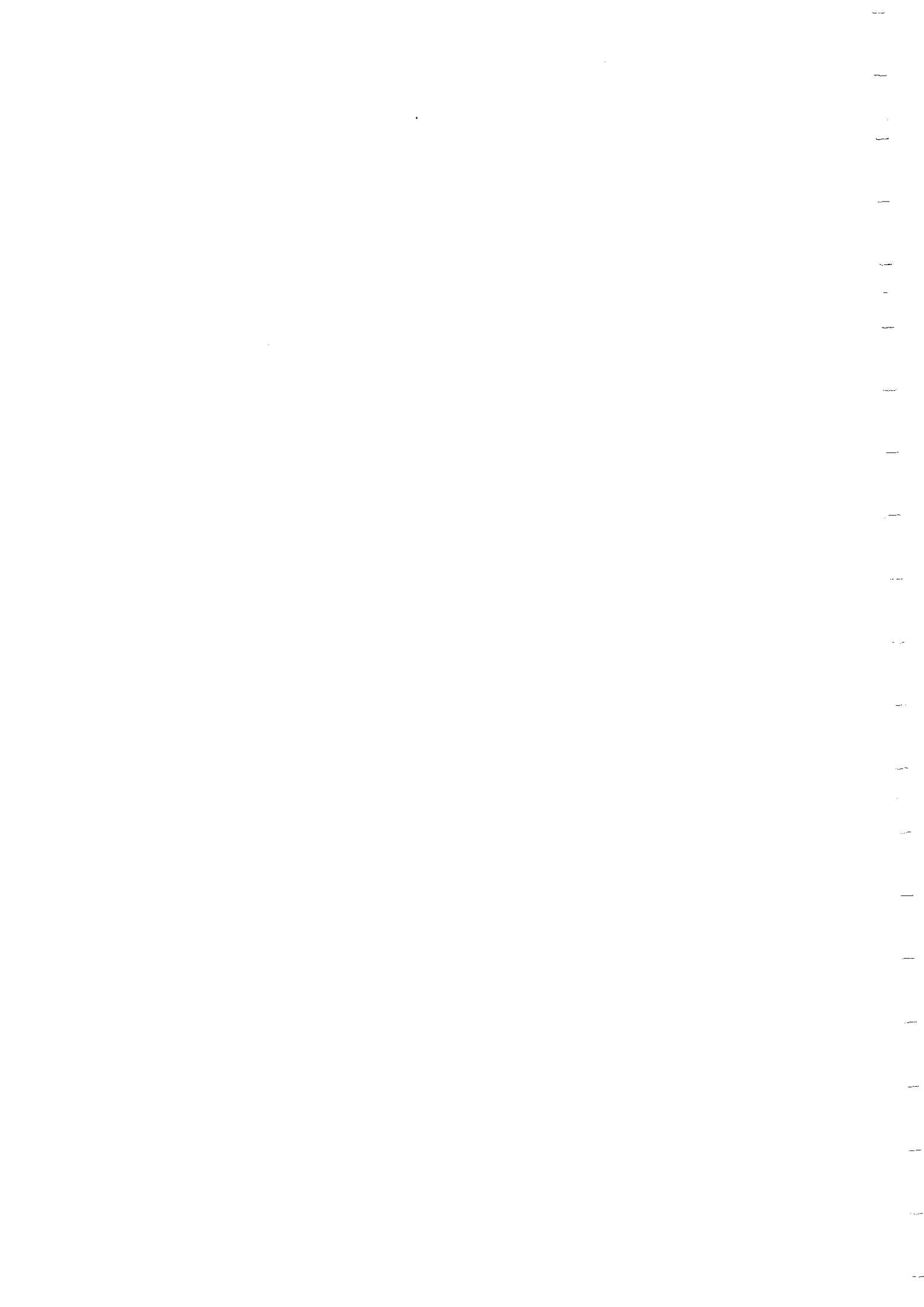
- Grow species or varieties that are resistant to the common pests in your area.
- Use treated seed.
- Spray only if absolutely necessary.

Note: Information on chemical control of weeds and insects should be available from government advisory officers, agricultural consultants, chemical resellers or spraying contractors.

3.6.3 Use of Fertiliser

Maintaining good nutrition is important for sustained production

All crops and pastures can benefit, in some situations, from additional fertiliser after seeding. Fertiliser can be added in many forms.



3.6.4 Grazing Management

New pastures can usually only stand light grazing in the first season. Perennial crops can also be grazed.

The following are some important points to remember:

- Graze only when plants cannot be pulled out
- Graze heavily for short periods to remove weeds.
- Some species need to set seed each year, so allow this to take place.
- Allow plenty of time for the pasture to recover after grazing.

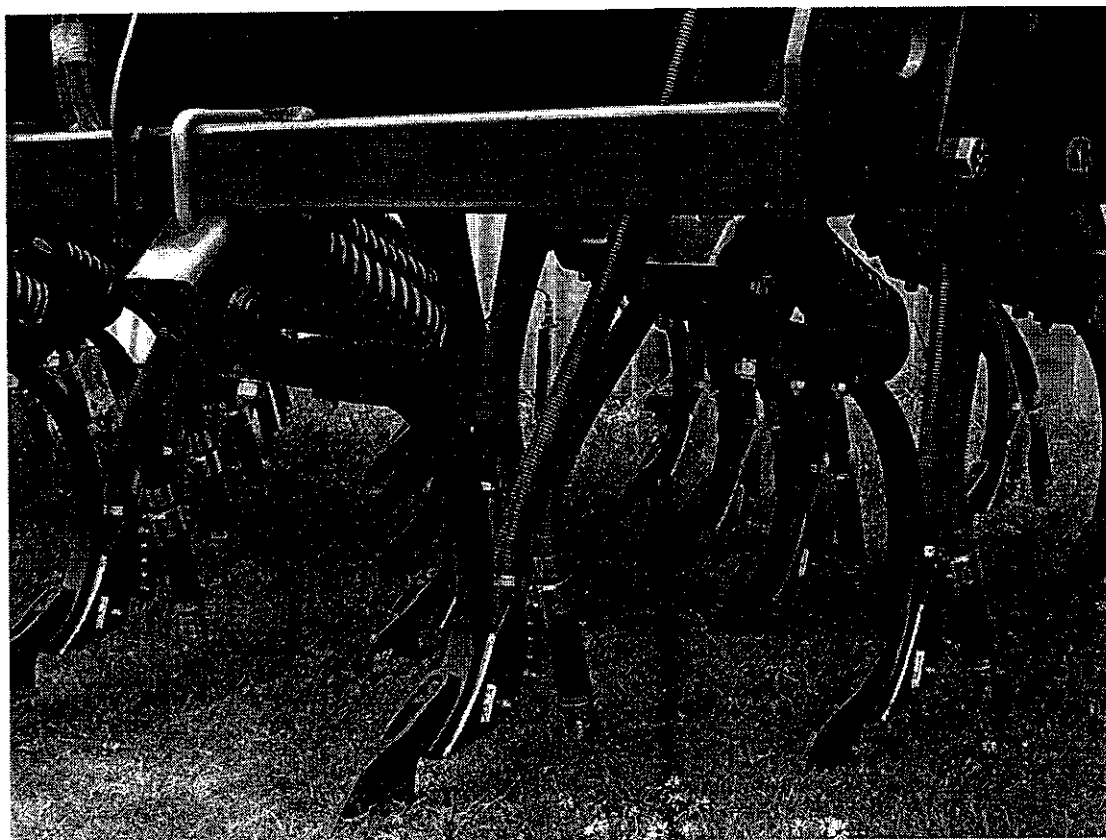
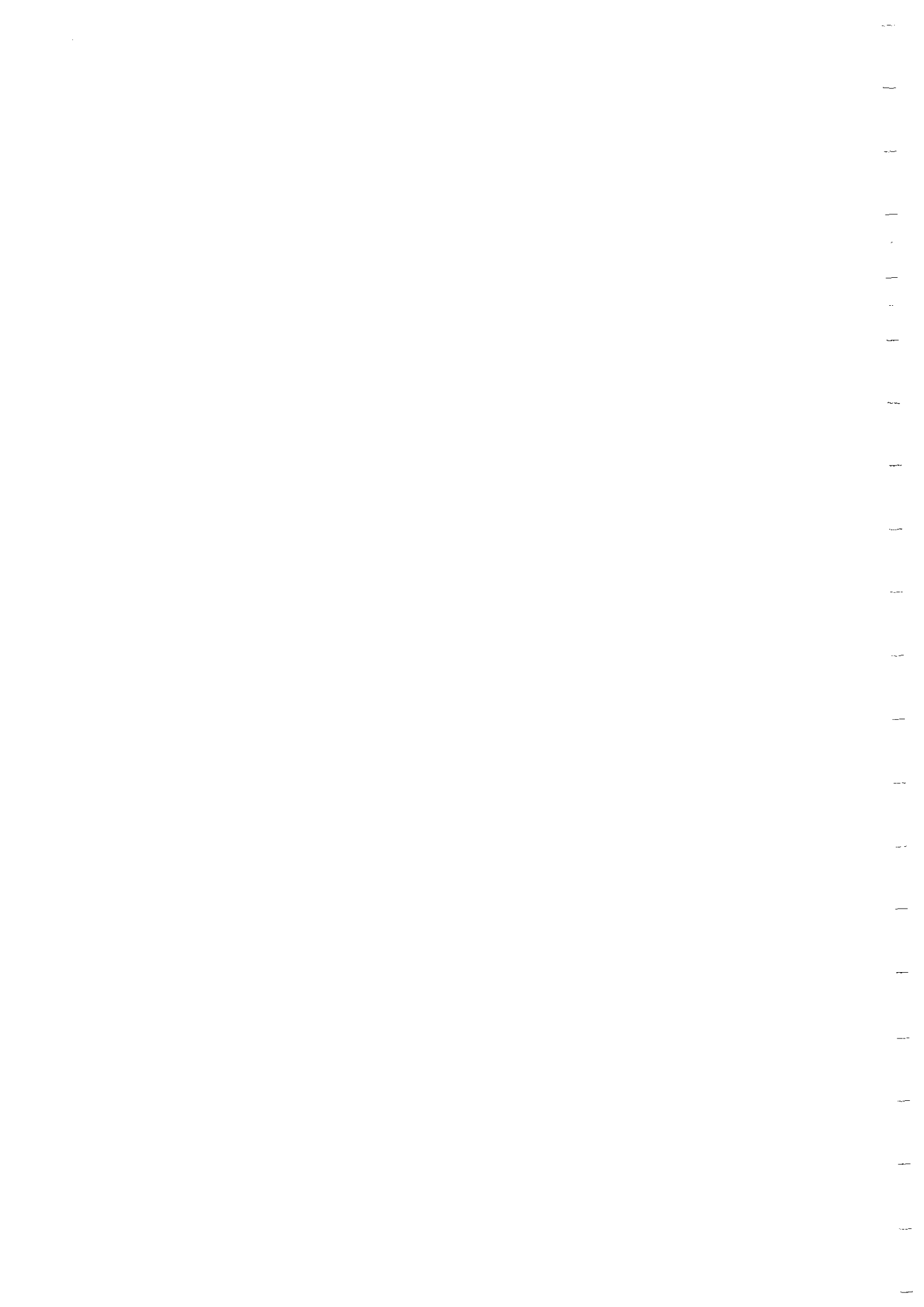


Figure 3.2: The JPC 2000 Series Agrowdrill is designed for both direct drilling and traditional tillage practices



4.0 Hectaremeter Installation

The electronic Farmscan 1100 Hectaremeter is designed to fit virtually any farm tractor. It displays and records area sown and displays working speed (km/h).

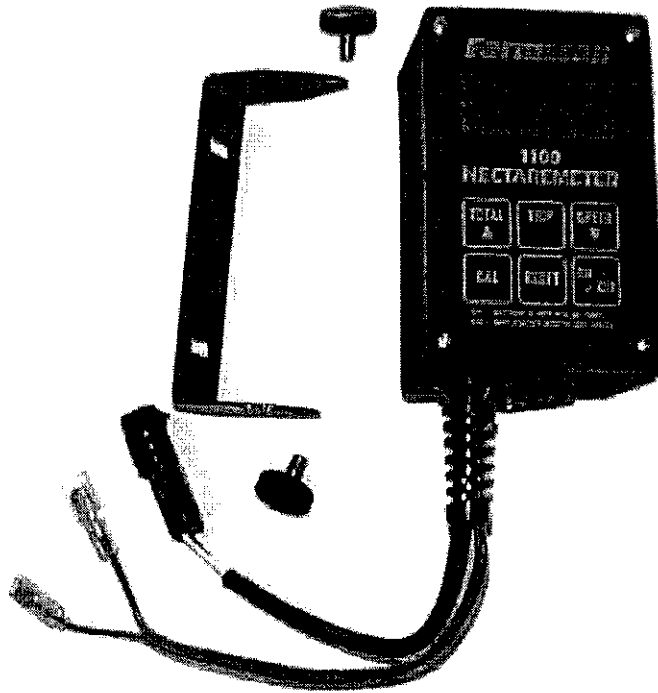


Figure 4.1: Hectaremeter and Mounting Bracket

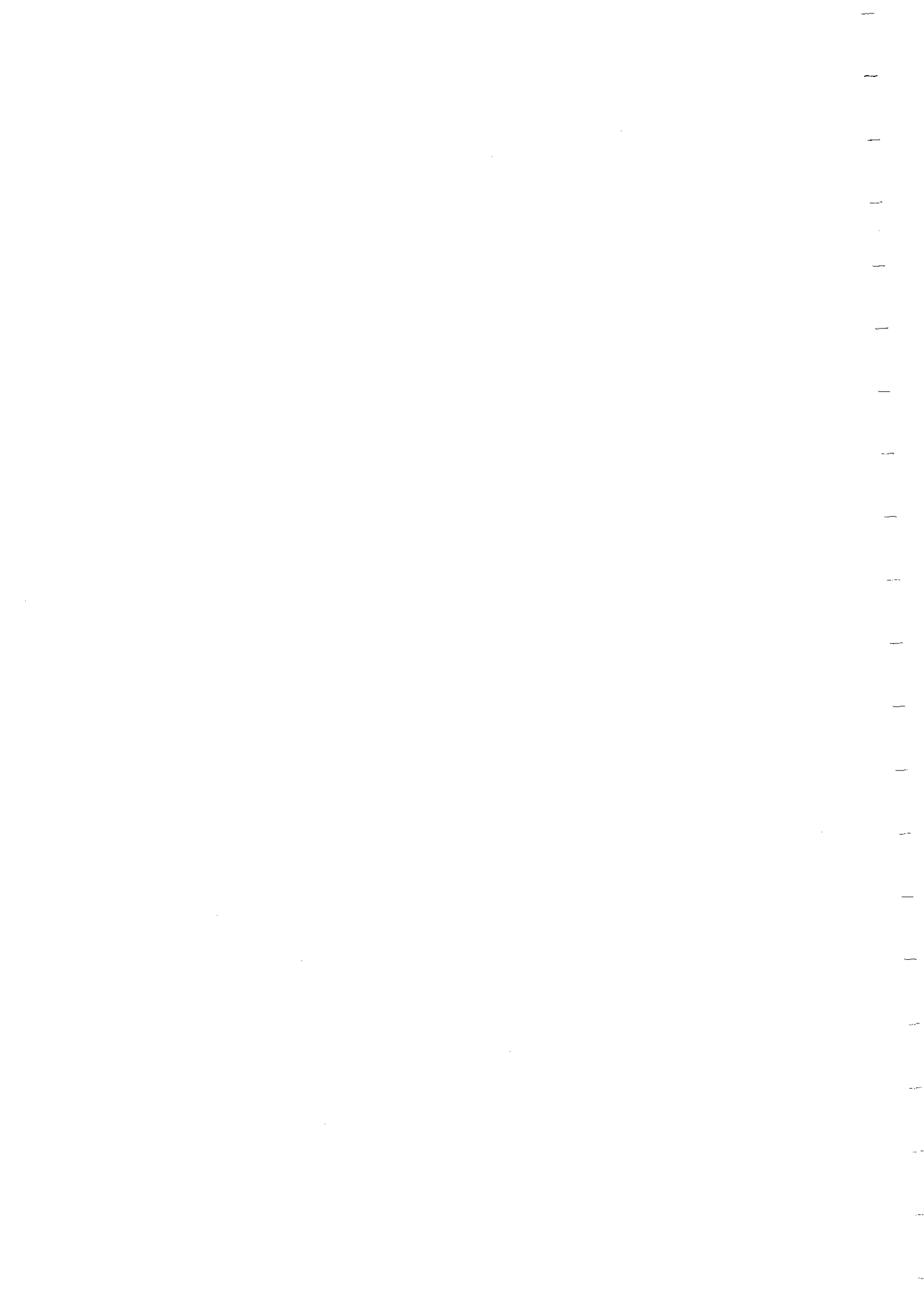
4.1 Installation Procedure

1. Mount the Hectaremeter in the tractor cab.

Mount the control unit in a convenient location in the cab using the bracket and securing knobs supplied. The unit is not waterproof and therefore must be installed in a tractor cab. It must be protected against moisture. Warranty will not cover moisture damage.

2. Connect and secure the cable from the Hectaremeter to the shaft sensor.

The cable should be secured with cable ties along the A-frame, away from any risk of damage such as lubricants and moving parts. Dust caps should be plugged together when the cable is in use to ensure dust caps stay clean. Make sure dust caps are fitted when the cable is not being used.



3. Power Connection.

Do not connect power until all other installation is complete.

The power cable must be connected DIRECTLY to the 12V DC vehicle battery terminals. DO NOT join power cable with any other electrical equipment or the vehicle chassis, as this may cause interference.

Use cable ties to secure power cable away from risk of damage.

Connection to battery terminals must be clean and tight.

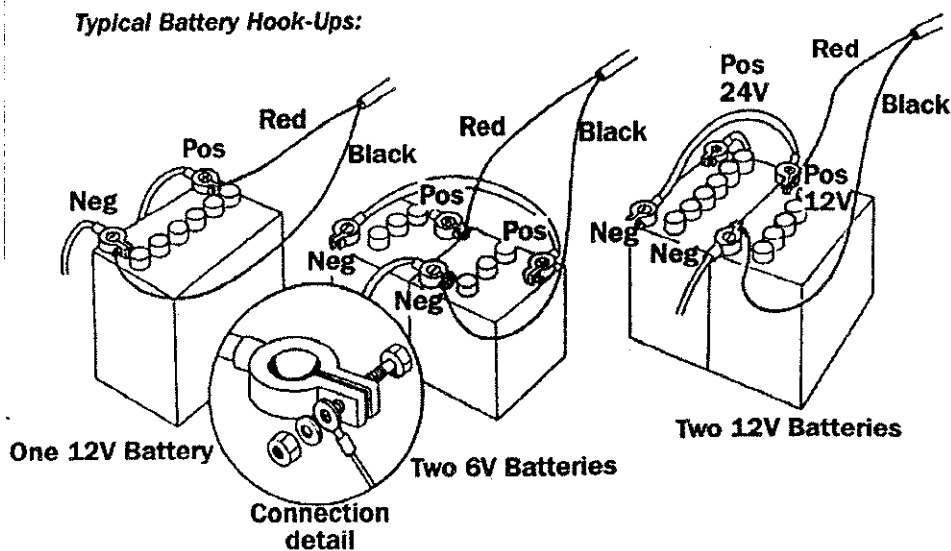


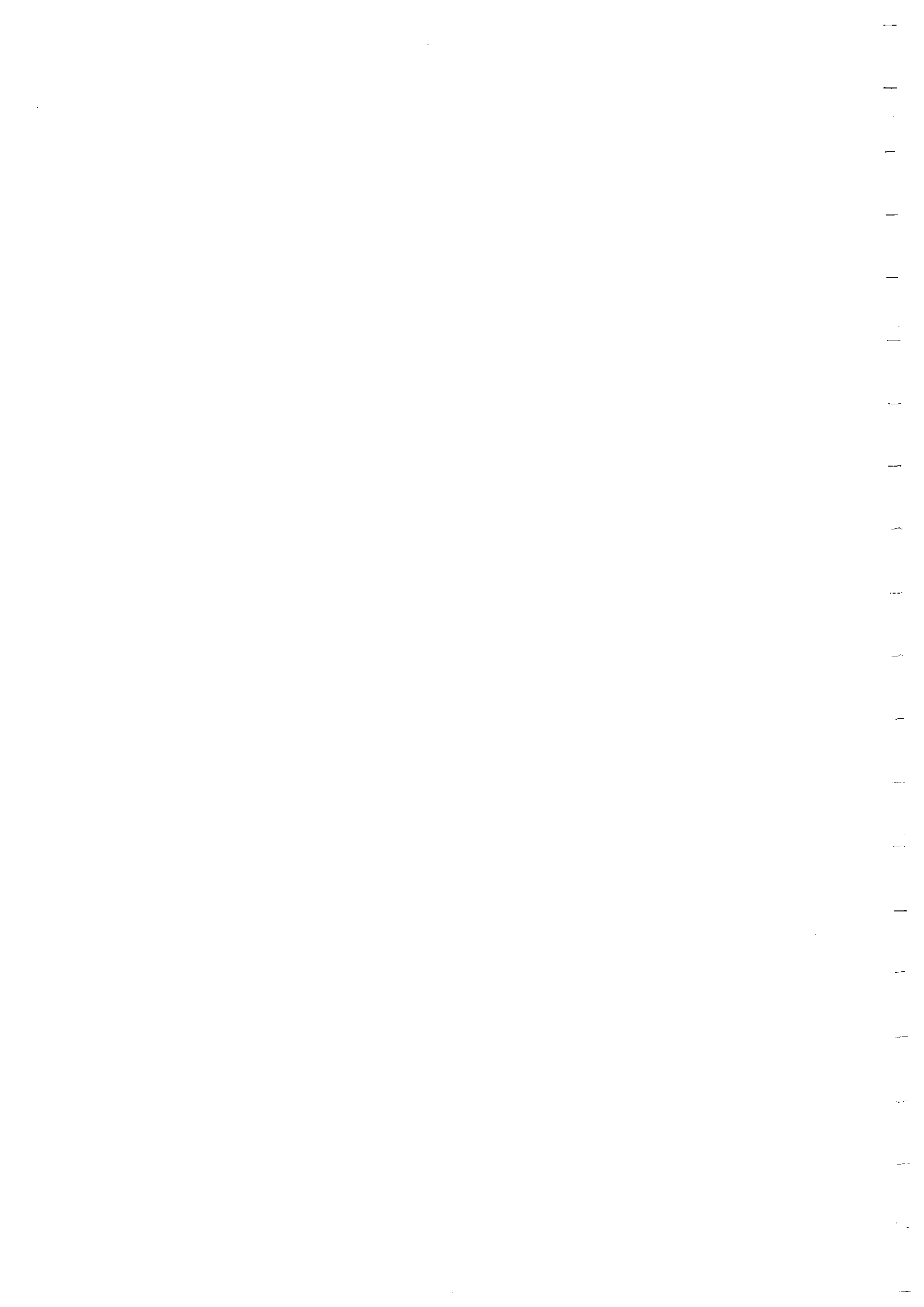
Figure 4.2: Hectaremeter battery connection

Warning: Disconnect power cable from battery when arc welding on machinery as damage to the unit will result.

4.2 Hectaremeter Shaft Sensor Installation

The Agrowdrill comes with the Hectaremeter shaft sensor already installed. In the event of replacement or relocation the following points must be considered.

- The magnet, fitted to the shaft, must sweep past the sensor once per rotation with a clearance of 3-5mm. Do not use substitute magnets.
- Clamp the shaft magnet around a shaft or lock collar that is driven by a ground wheel. The clamp is adjustable from 19mm up to 38mm diameter. The magnet can be transferred to a larger clamp if required.
- The sensor and the magnet must face end to end.



- Do not remove the sensor from the aluminium bracket, as damage to the sensor will result.

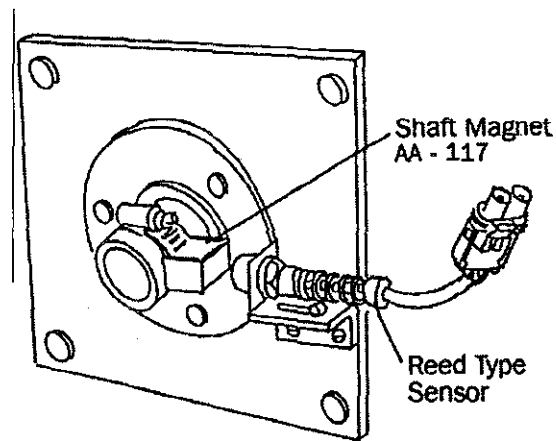


Figure 4.3: Shaft Sensor Installation

- As the sensor is not affected by moisture or mud the main precaution is to protect the sensor and cable from physical damage. As a precaution keep the sensor cable away from aerial leads, engine kill switch cables or wires to electronic clutches and solenoid valves. Use the cable ties provided to secure the sensor cable.

5.0 Operating Instructions

5.1 Hitching and Levelling

The Agrowdrill should be matched to the tractor size to maximise performance and efficiency. A mismatched tractor and implement will be inefficient and cost money, as well as being unsafe.

5.1.1 Hitching

The hitching procedure is as follows:

1. Pin the tractor drawbar into the central position.
2. Attach the Agrowdrill to the drawbar and set the adjustable levelling tube so that the machine is approximately level.

Warning: Ensure the drawbar pin is locked into position so that it cannot work itself out when the machine is in operation or transit. Failure to do this may result in serious injury or death.

3. Attach the hydraulic coupling to your tractor remote outlet, taking care to clean away any dirt.

The working depth of the Agrowdrill is controlled by the hydraulic rams attached to the wheel assemblies. These are operated by the remote hydraulic system.

On some tractors it is necessary to set the hydraulic system to operate in the "single acting" or "bypass". Consult the tractor operator's manual.

4. Disengage the jack stand and adjust the hitch level to suit the drawbar height of the tractor. When level, ensure the levelling tube is locked using the locknut.

5.1.2 Hydraulic Lift Circuit

The procedure to connect and prime the hydraulic lift circuit is as follows:

1. Ensure both the tractor remotes and the hose couplings are clean and then connect to the tractor.
2. Loosen the hydraulic connector on the input line of the right hand wheel lift cylinder (see figure 5.1). This should be done to allow air to escape while the hydraulics are being primed.

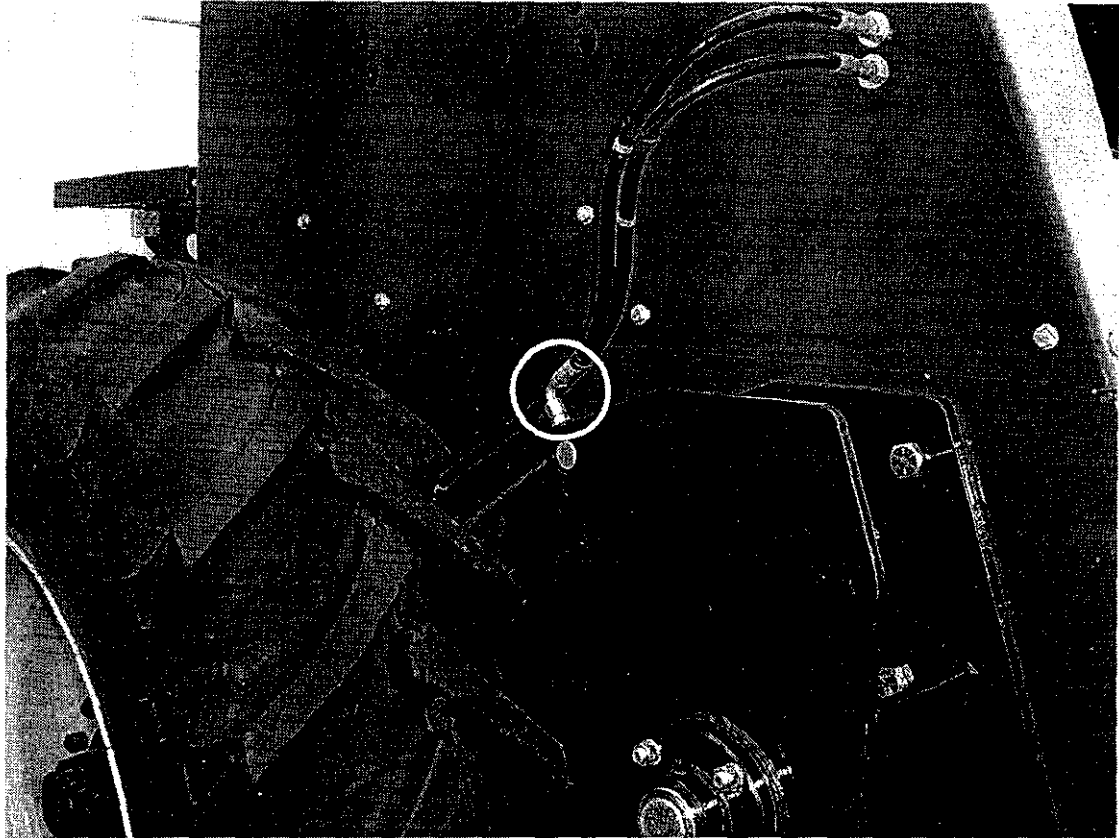


Figure 5.1: Right Hand Wheel Lift Cylinder

3. Slowly pressurise the hydraulics until oil appears at the loosened connection on the right hand cylinder.

Note: Stand well clear of the loosened connection as oil under pressure can spray wildly outwards. It is a good idea to place a hessian bag or similar material over the connection to minimise oil movement.

4. Retighten the connection as soon as oil appears.
5. Continue to prime the hydraulic lift circuit until the right hand cylinder is fully extended. Hold the hydraulics open for a further 15 to 20 seconds to allow air to clear from the circuit.
6. Fully raise and lower the machine several times to expel any residual air trapped in the circuit.

The lift circuit is now fully primed and the Agrowdrill can now be moved.

5.1.3 Levelling

The Agrowdrill must be level while operating. The levelling procedure is as follows:

1. Start working at the desired depth and observe the machine from both the side and the rear.
2. Adjust the levelling tube so that the machine is level from front to rear.
3. Retighten the locking collar on the levelling tube when adjustments are completed.

It is very important that the Agrowdrill be levelled correctly to achieve good results. As a final check, dig to the bottom of the furrow at two or three points across the working width of the machine and check the seeding depth. Ensure that the front and rear tyres are seeding at the same depth.

5.2 Tyre Pressures

Ensure that both tyres are inflated to a pressure between 250 – 285 kPa (35 – 40 psi). A low tyre pressure on one side will cause an uneven seeding depth.

5.3 Seeding Depth

Seeding depth will vary depending on the species being sown. Generally speaking, small seeded species should be sown shallower. Larger seeded species will emerge if sown deeper.

The following are important guidelines:

- Seeding deeper than recommended will drastically reduce the chances of good germination and emergence.
- In hot, dry conditions the topsoil will tend to dry out rapidly and lead to poor germination.
- In wet, cool conditions the topsoil will remain moist and shallow placed seed will germinate effectively.

Consult a seed reseller or Advisory Officer for a recommendation regarding seeding depth if unsure.

5.4 Row Spacing

The row spacing of the Agrowdrill is infinitely variable. The only restriction will be the number of outlets on the hopper.

In some conditions it may be advantageous to seed in 127mm rows eg Irrigated Lucerne or Ryegrass. Other crops or pastures may require a wider spacing eg Sorghum at 350mm.

Consult a seed reseller or Advisory Officer for a recommendation regarding row spacing if unsure.

5.5 Operating Speed

The Agrowdrill will produce the best results if operated between 4 and 8 km/h. Optimum speed will vary with the soil type, vegetative cover and root matter present.

Operating at higher speeds will increase soil surface disturbance, reduce penetration and seriously reduce the accuracy of seed and fertiliser placement. High speeds will also increase wear on the openers.

5.6 Hopper Selection

The metering system in all hoppers is identical meaning seed or fertiliser can be used in any hopper. In deciding which hopper to use it may be necessary to take into account and blending or banding options that may be used.

Model	20R	24R	28R	32R
Bin 1	527 litres	612 litres	741 litres	827 litres
Bin 2	479 litres	588 litres	675 litres	753 litres
Bin 3	479 litres	588 litres	675 litres	753 litres
Bin 4	527 litres	612 litres	741 litres	827 litres

Table 5.1: JPC 2000 Series Agrowdrill hopper capacities.

6.0 Calibration Instructions

6.1 Farmscan 1100 Hectaremeter

Before you can use your Agrowdrill the Hectaremeter must be calibrated and the metering rates must be checked for both seed and fertiliser.

Warning: If the Hectaremeter and metering system calibration is not carried out carefully then any data obtained will be unreliable.

The Hectaremeter must be calibrated to suit the width and distance the Agrowdrill travels per pulse from the shaft sensor.

The width and distance calibration factors are permanently stored in the memory whenever the 'CAL' routine is completed, as outlined below.

Important: If the calibration factors are corrupted due to outside interference, the readout will display 'HELP' to show that the calibration factors must be checked.

For ease of calibration both the width (Sowing Width) and Distance (Pulse Distance) calibration factors for a range of Agrowdrill configurations are supplied on section 6.10.

6.2 Operation of the Hectaremeter

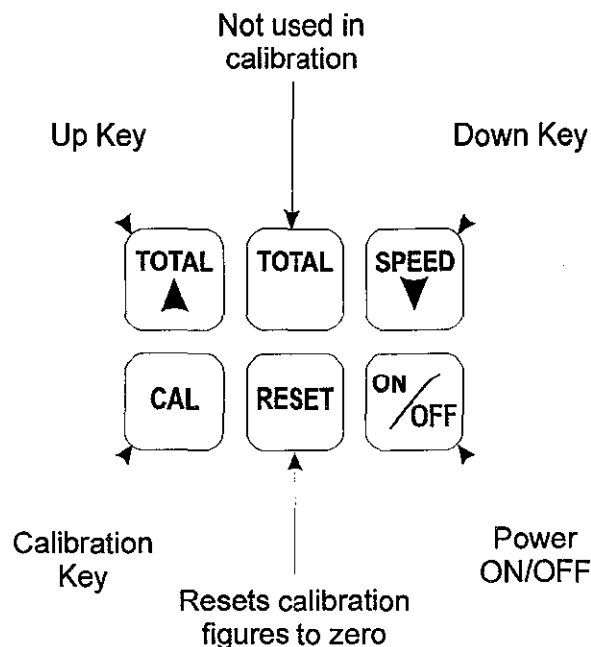


Figure 6.1: Farmscan 1100 Hectaremeter Calibration Keys

ON/OFF KEY:

The ON/OFF key turns the Hectaremeter power ON or OFF. Whenever the Hectaremeter is turned ON the TOTAL hectares will be displayed first. From this point you can select any other key

TRIP KEY:

The TRIP key displays the trip Hectares and works just like the trip meter in your car. You can reset the TRIP Hectares for each paddock or load without losing the TOTAL Hectares.

Maximum trip reading is 999.9 Hectares.
Resolution is 00.00 to 99.99 then 100.1 to 999.9 Hectares.

RESET KEY:

Use the RESET key to set the TOTAL or TRIP Hectares back to zero. After selecting either TOTAL or TRIP Hectares, hold the RESET key down for approx. 3 seconds to clear the displayed figure back to zero.

SPEED KEY:

The SPEED key displays the working speed (km/h) at any time whilst travelling.

MEMORY:

Both the TOTAL and TRIP area readings are automatically stored in permanent memory - every 6 minutes of operation or when the unit is switched OFF using the ON/OFF key. The last 6 minutes of operating data will be lost if the power is interrupted at the source without first switching the unit of using the ON/OFF key.

FLASHING DECIMAL POINT:

The decimal point on the display will flash for each pulse the meter receives from the shaft sensor to indicate that the unit is working. The sensor being mounted on the drive shaft enables the flashing decimal point to be interpreted that the drive shaft is engaged and turning.

6.3 Calibrating the Hectaremeter

Follow the steps below to enter the calibration factors.

1. Switch the Hectaremeter on.
2. Press the 'CAL' key to display H1 (The distance calibration factor)
Eg. H1
0000

3. Use the up and down arrow keys to set the distance calibration factor to the Pulse Distance (in millimetres) as shown on the calibration chart for your model Agrowdrill.
Eg. 2557
4. Press the 'CAL' key again to confirm the previous setting and display H2 (The width calibration factor)
5. Use the up and down keys to set the width calibration factor to the width (in metres) For standard configurations this distance can be obtained from section 6.10 or simply measure the distance from outside tyne to outside tyne and add one row spacing.
6. Press the 'CAL' key again to confirm the width setting, store them in memory and exit the calibration cycle. The Hectaremeter is now calibrated.

6.4 Metering Rates

Due to variations in seed sizes that can occur from crop to crop, season-to-season as well as normal variations between varieties, the gearbox and quadrant settings given on the calibration charts for seed and fertiliser should be used as a **guide only**. Cleanliness of samples will also effect actual rates, especially with oaten and some barley varieties.

For total accuracy it is recommended that you check the rate of flow from the metering system for each seed and fertiliser to be used. This will provide very accurate rates of seeding, and can be recorded for future reference. Blank charts have been provided for you to record your own specific charts for future use.

6.5 Method for Checking Metering Rates

Our recommended static methods of checking metering rates use:

- An accurate set of electronic scales (accurate to at least 2 grams) most electronic kitchen scales will suffice.
- A small amount of seed and/or fertiliser.
- The use of five seeding rows to test each sample.
- Small containers to collect the seed and/or fertiliser.

If you do not wish to purchase a good set of electronic scales, it will be necessary to meter each sample through all hoses used across the machine and for a greater working distance. You must obtain a sufficient amount quantity for a reasonable degree of accuracy with conventional scales.

6.5.1 Calibration Procedure

1. **Establish the working width of your drill.**
 - 1.1 Measure the row spacing in metres.
 - 1.2 Multiply this figure by the number of rows on your machine.

2. **Determine the rolling circumference of your drive wheel.**
 - 2.1 Ensure the tyre is inflated to recommended pressure.
 - 2.2 Lift the machine into transport position.
 - 2.3 Mark the tyre at contact point with the ground.
 - 2.4 Place a peg or marker at this same location.
 - 2.5 Tow the machine for x number of wheel revolutions. (The greater the number of revolutions used the more accurate the calculation.)
 - 2.6 Measure the distance travelled (in metres) and divide by x to obtain the rolling circumference.

3. **Calculate the number of wheel revolutions per Hectare.**
 - 3.1 Using the information obtained in steps 1 & 2 above use the following formula
 - 3.2
$$\text{Wheel Revs/ Ha} = \frac{10000}{\text{Wheel Circ.} \times \text{Working Width}}$$

4. **Calculate idle shaft revolutions per Hectare.**
 - 4.1 This calculation is simply the Wheel Revs/Ha (see 3.2) multiplied by the idle shaft ratio for your drill. The ratio for the JPC 2000 Series Agrowdrill is as follows:

$$\text{Idle Shaft Ratio} = 1.96$$

5. **Distance to travel a Hectare.**
 - 5.1
$$\text{Distance to travel Ha} = \frac{10000}{\text{Working width}}$$

6. **Hectare meter settings.**
 - 6.1
$$\text{H1 - Pulse Distance} = \frac{\text{Wheel Circumference}}{\text{Idle Shaft Ratio}}$$
 - 6.2 H2 - Working Width (see 1 above)

For Example:

An 20 Run Drill with 24 tynes at 178mm spacing.

From (1) the working width = 24 x 0.178
 = 4.272m

From (2) the wheel circumference is 5.01m

Therefore using the formula in (3.2):

$$\begin{aligned} \text{Wheel Revs / Ha} &= 10000 / (5.01 \times 4.272) \\ &= 467.23 \end{aligned}$$

Therefore using equation (4.1)

$$\begin{aligned} \text{Idle shaft revs} &= 467.23 \times 1.96 \\ &= 915.77 \end{aligned}$$

Using equation (5.1):

$$\begin{aligned} \text{Distance to travel Ha} &= 10000 / 4.272\text{m} \\ &= 2340.8\text{m} \end{aligned}$$

To calibrate your drill:

1. Set the quadrant lever on the approximate setting indicated from the rate charts.
2. Position containers to collect from a number of hoses. (The more hoses used the more accurate your calibration. Usually 5 hoses are adequate.)
3. Turn the crank handle the equivalent of a Ha, 467.23 revs, or a fraction thereof. (It follows that the closer to Ha you use the more accurate your calibration) In general figures 1/50th of a Ha has proven adequate. For the above this would be 1/50th of 467.23 = 18.25 revs.
4. Collect the material from the containers and weigh this. Say 417 grams was collected.
5. Unless you collected from all 24 hoses and turned the crank handle 915.77 turns, you will need to amend the weight collected as follows:

$$\text{kg / Ha} = \frac{\left(\text{Weight of seed collected} \times \left(\frac{\text{Number of Rows on Drill}}{\text{Number of Rows Collected}} \right) \times \text{Fraction of Ha} \right)}{1000}$$

It should be noted that by collecting seed from five (5) hoses and cranking the equivalent of 1 / 50th of a Ha, the above formula will simplify to:

$$\begin{aligned} \text{kg / Ha} &= \text{Weight Collected} \times \text{Number of rows on Drill} / 100 \\ &= 417 \times 24 / 100 \\ &= 100 \text{ kg / Ha} \end{aligned}$$

Alter the gearbox quadrant setting up or down as required and repeat the procedure until the desired seeding rate is required.

6.6 Field Calibration

The following procedure can be used to determine the precise application rate during the seeding operation:

1. Fill the hopper to the top and level the seed and fertiliser.

2. Set the trip meter on the Hectaremeter.
3. Commence seeding and work until the hoppers are more than half empty.
4. Refill the hoppers taking careful note of the amount added in kilograms.
5. Note the number of hectares indicated.
6. Calculate the actual sowing rate using the following formula:

$$\text{Kg / Ha} = \text{Kg of seed or fertiliser used / Hectares sown}$$

7. Readjust rates as necessary.

6.7 Plotting Calibration Charts

This procedure will allow for the plotting of calibration charts for seeds or fertilisers not listed or for the modification of existing charts.

1. Set the varibox adjusting lever to the maximum setting and carry out the calibration procedure as outlined in the section above.
2. Select a blank chart (or draw a new one) suitable to the seeding rate achieved.
3. Find the point on the x-axis (bottom) that corresponds to the achieved seeding rate.
4. Mark a point on the maximum quadrant setting line that corresponds to the achieved seeding rate.
5. Draw a straight line from this point to the bottom left hand corner (0,0).

This line indicates the approximate amount of seed or fertiliser rate at any given quadrant setting.

6.8 Adjusting the Seed and Fertiliser Rates

Adjusting the seed and fertiliser rates on the Agrowdrill is very simple as it only involves three components:

- Gearbox.
- Restrictors applied to the fluted rollers.
- Adjustable gates under the fluted rollers.

All three may need to be adjusted.

6.8.1 Gearbox Adjustments

The Agrowdrills unique gearbox allows adjustments of seed and fertiliser rates over a wide range by simply adjusting one lever for each.

The levers are located on the bottom of the hopper in the centre of the machine. The lever closest to the front of the machine adjusts the front hopper.

To adjust the rates simply rotate the handle in an anticlockwise direction to loosen and slide the lever up or down the scale as required, and increase in number indicates an increase in speed. Once at the necessary position rotate the handle in a clockwise direction to lock the lever in place.

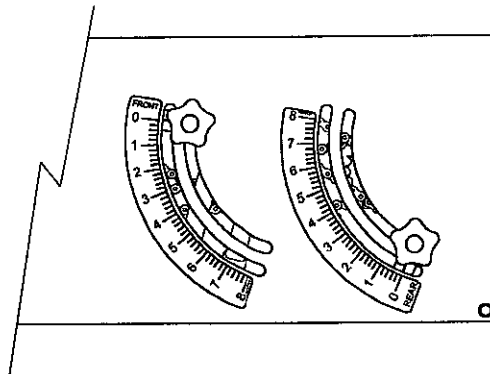


Figure 6.2: Minimum Rate Varibox Settings

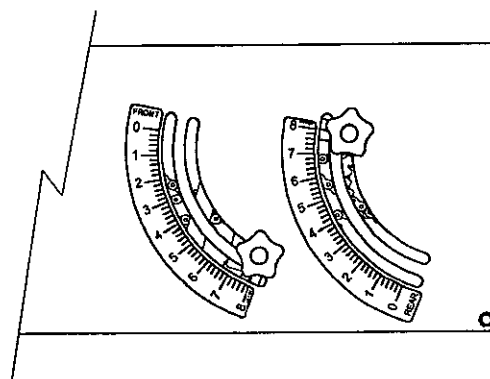


Figure 6.3: Maximum Rate Varibox Settings

6.8.2 Restrictors

The fluted rollers (identical for both seed and fertiliser) have a coarse and a fine side.

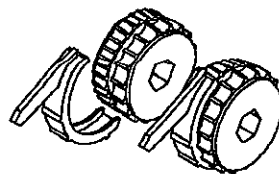


Figure 6.4: Fluted Rollers and Restrictors

This design allows both large and small seeds to be accurately metered. The Agrowdrill can handle a wide range of seed sizes with the minimal adjustment of fitting or removing restrictors.

Recommended Restrictor and Gate Settings:

Seed	Gate Setting	Restrictors Fitted
Lupins	3	No
Oats	3	No
Wheat	2	2 of 4
Canola	0.75	3 of 4
Sub Clover	1	3 of 4
Lucerne	1	3 of 4
Single Super	2	No
DAP	1.5	No
Urea	1.5	No

To reposition Restrictors:

1. Grasp the rear arm of the restrictor and gently twist the arm sideways to release it from under the adjustable stopper and remove
2. Reinsert the restrictor into the new position or leave out as required.

6.8.3 Gate Settings

The gate adjustment levers are located on the right hand end of the Agrowdrill, the front lever adjusting the front hopper. In most circumstances you will not need to adjust the gate settings. The gates may need to be opened to meter very large seeds.

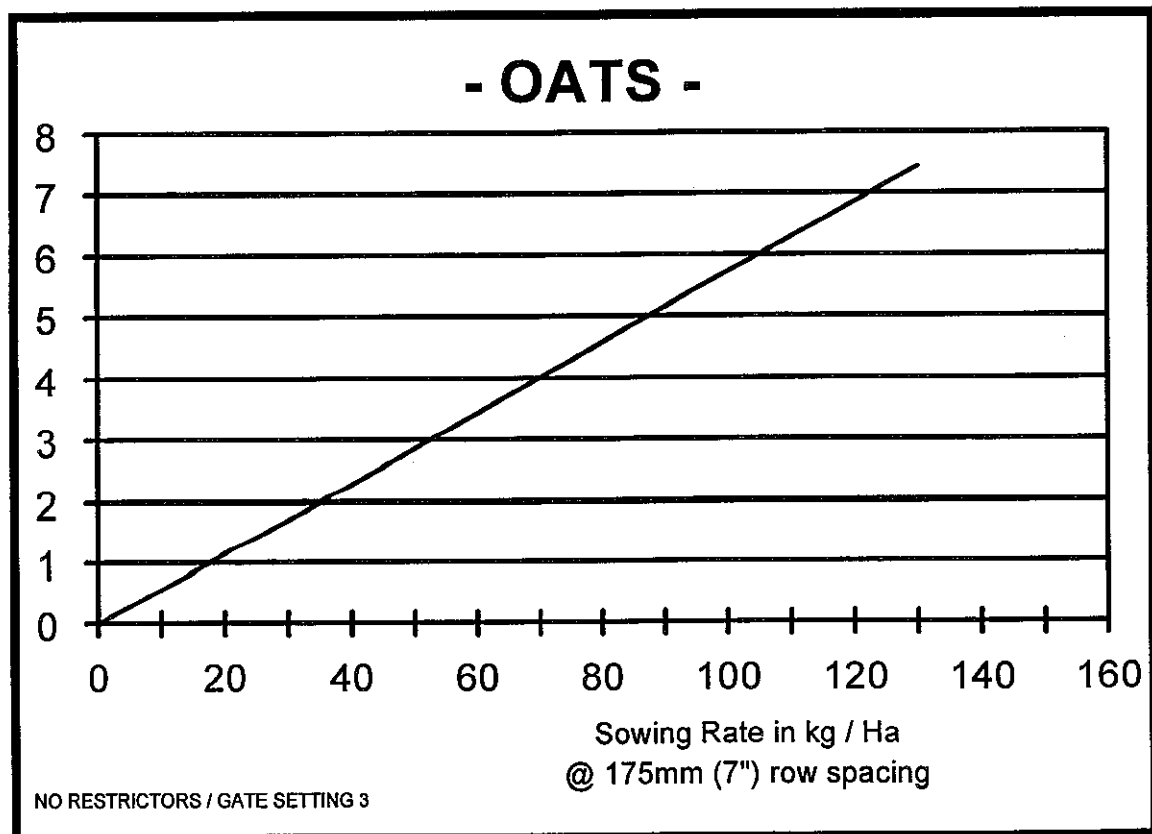
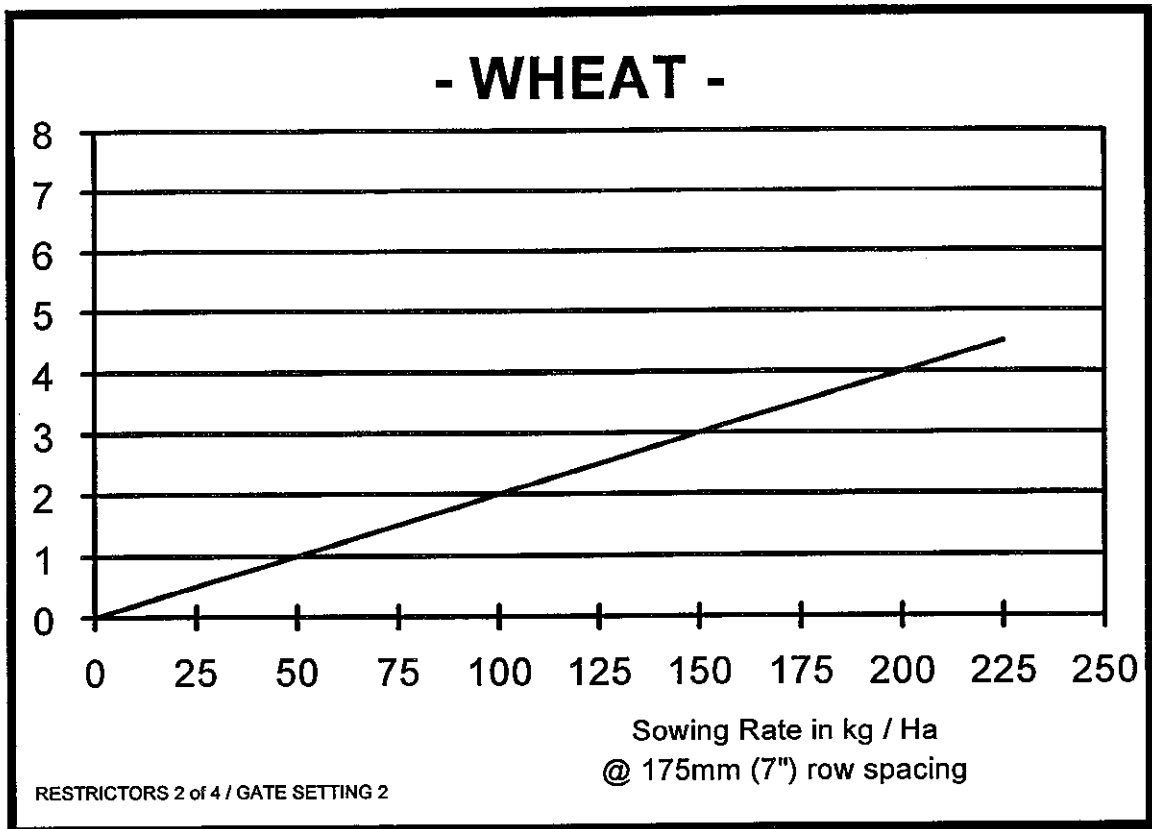
Adjust as follows:

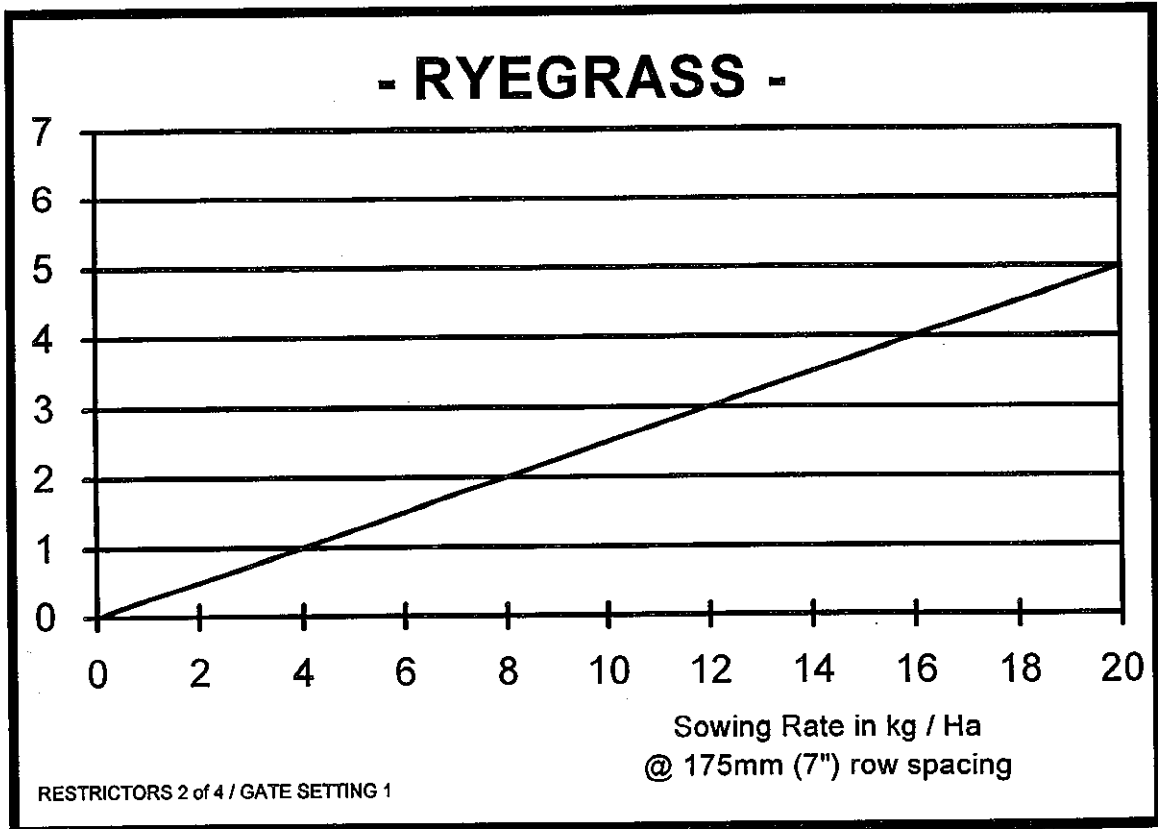
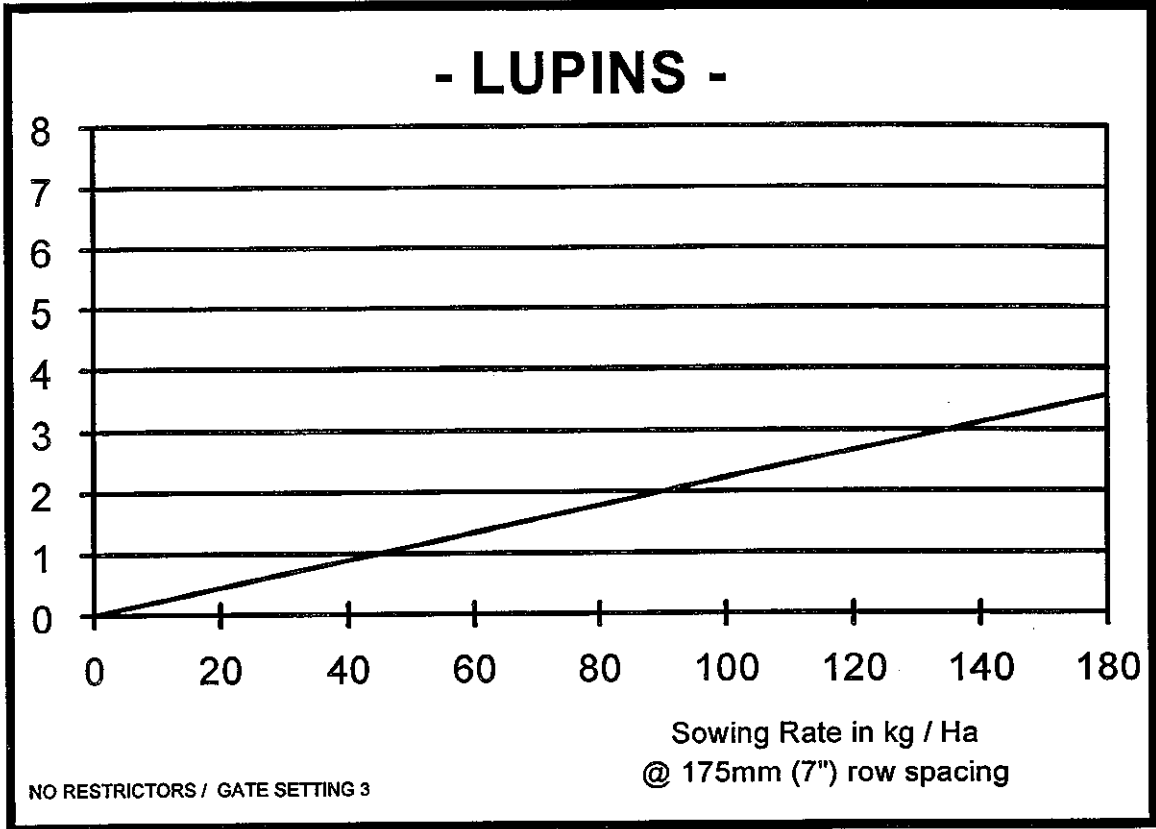
1. Check the gate setting recommendation for the seed or fertiliser being used (refer to the above table).
2. Loosen the Knob (rotate in an anticlockwise direction) slide the lever up or down the scale as required. Once at the necessary position lock the lever in place (rotate the knob in a clockwise direction).

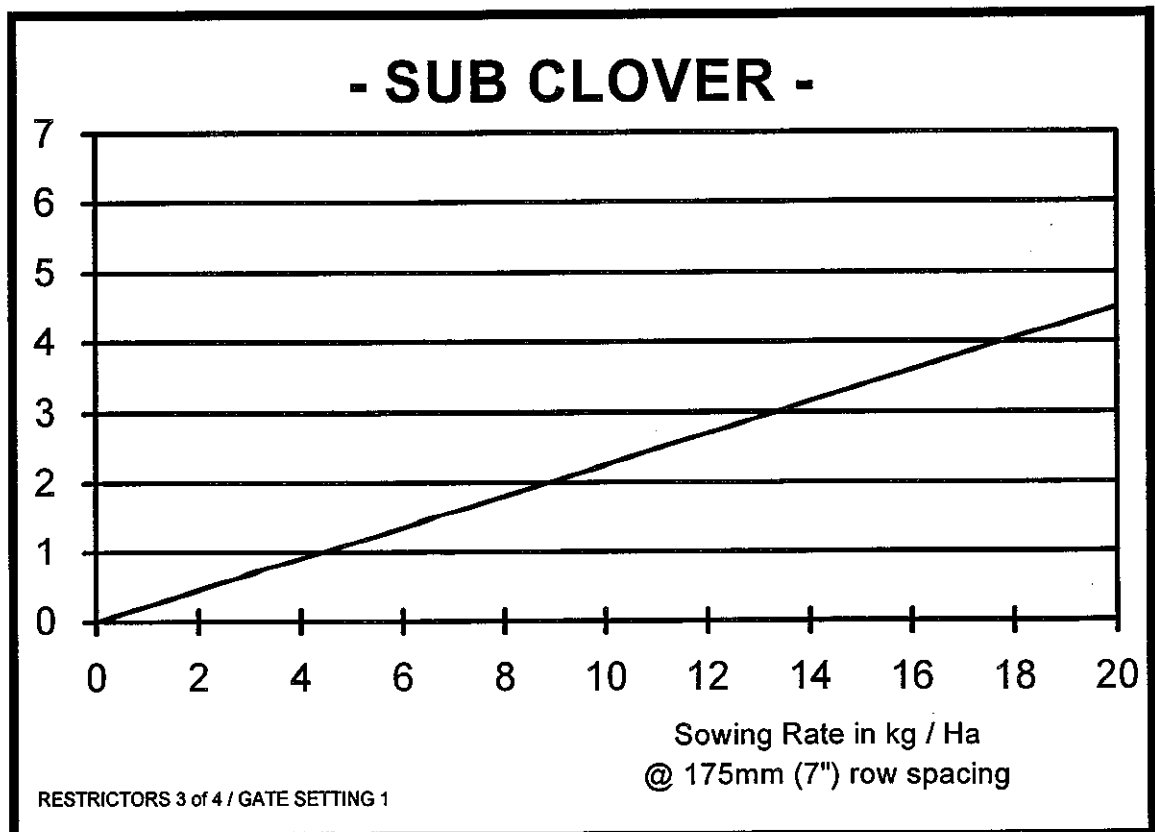
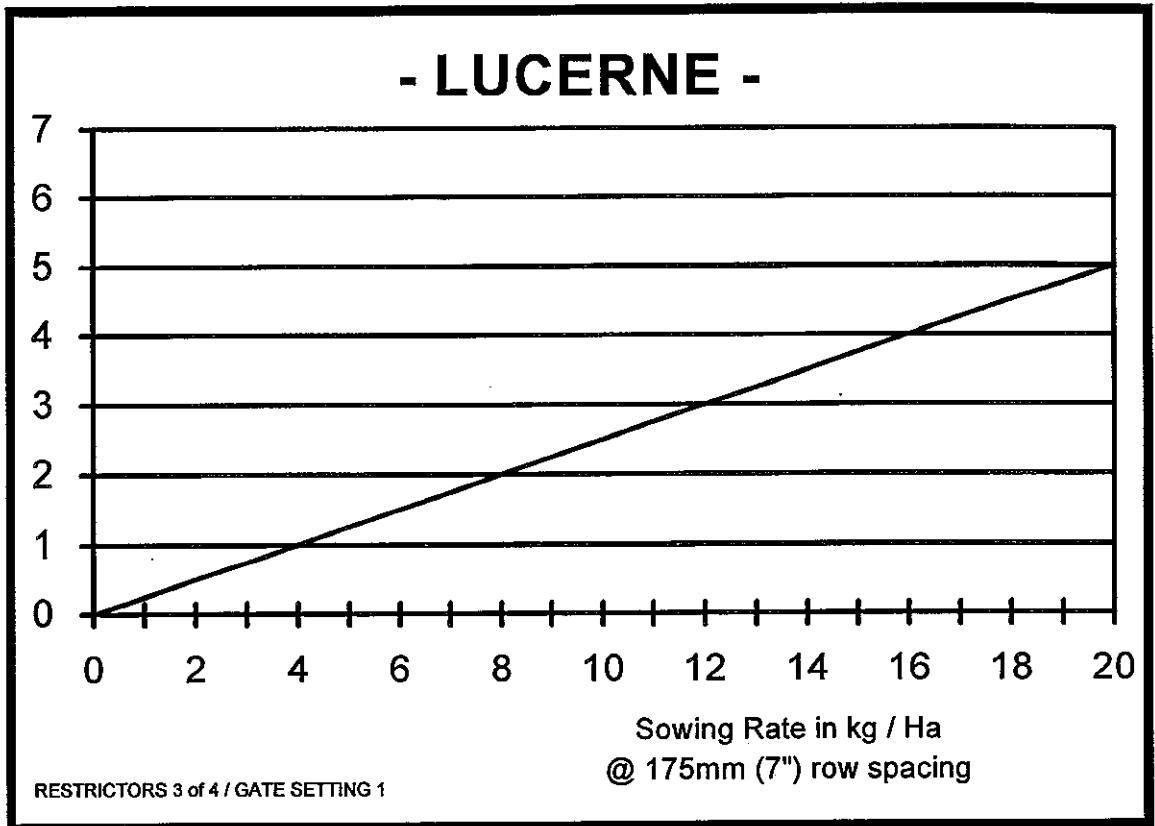
6.9 Calibration Charts

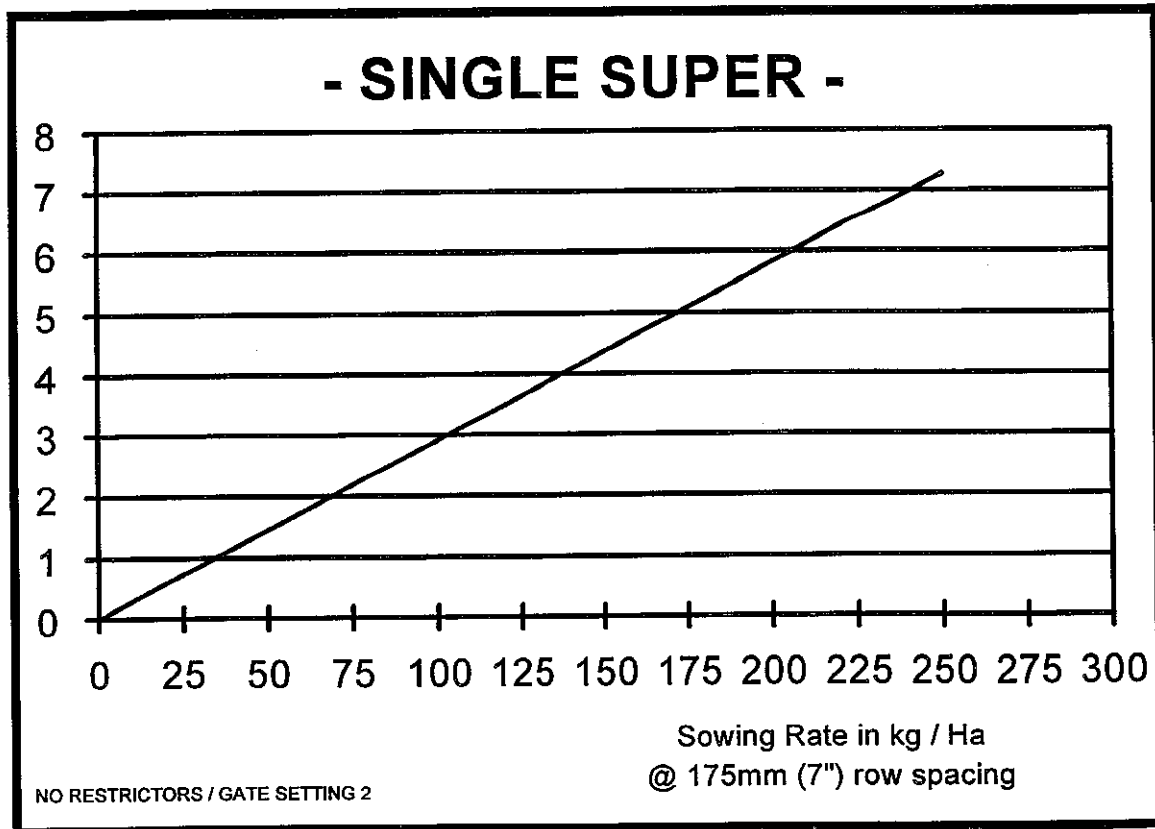
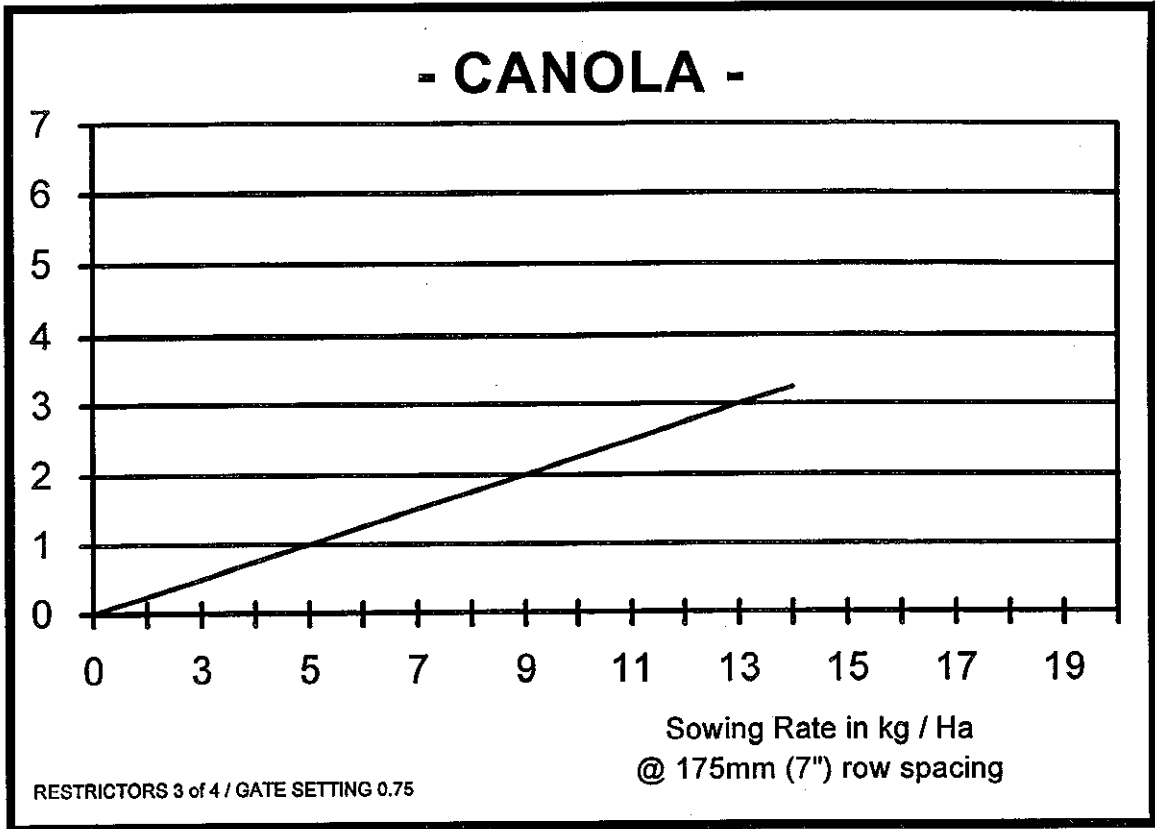
The following charts are intended as **guide only**. They are based on a standard row spacing of 175mm and do not take into account variety changes or cleanliness of the sample.

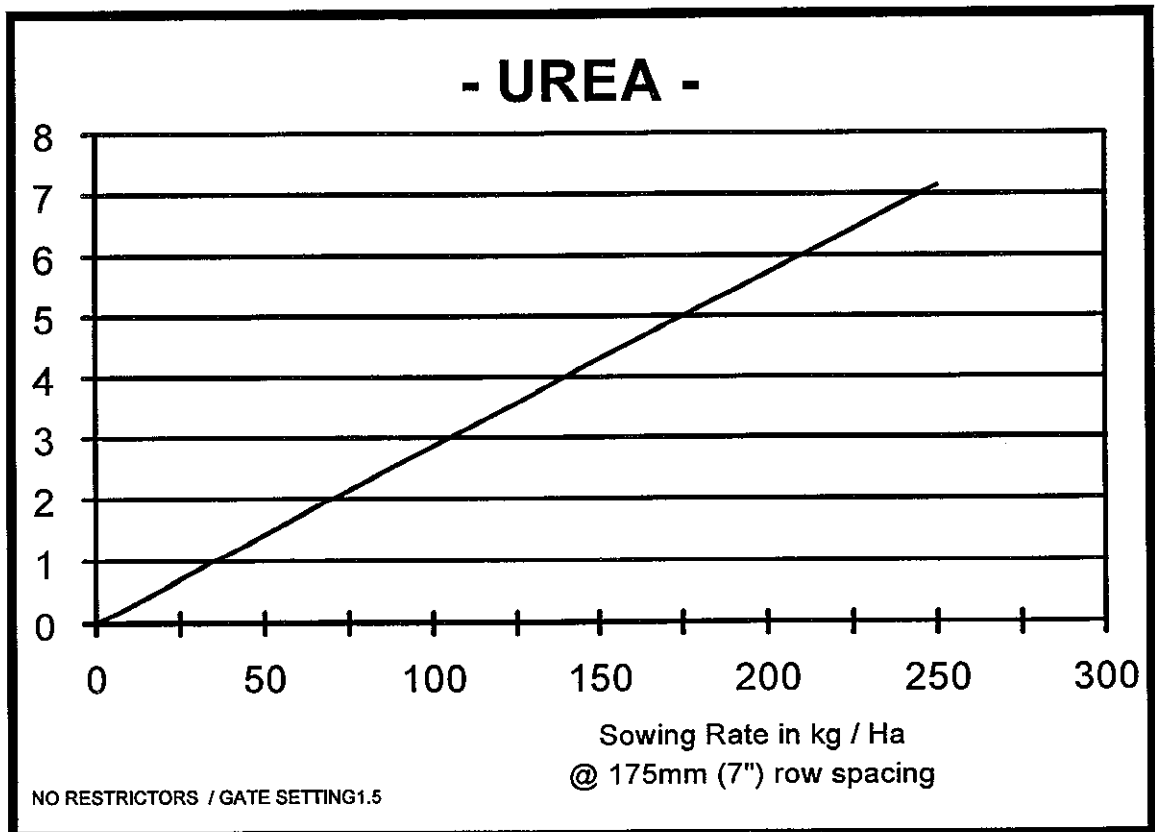
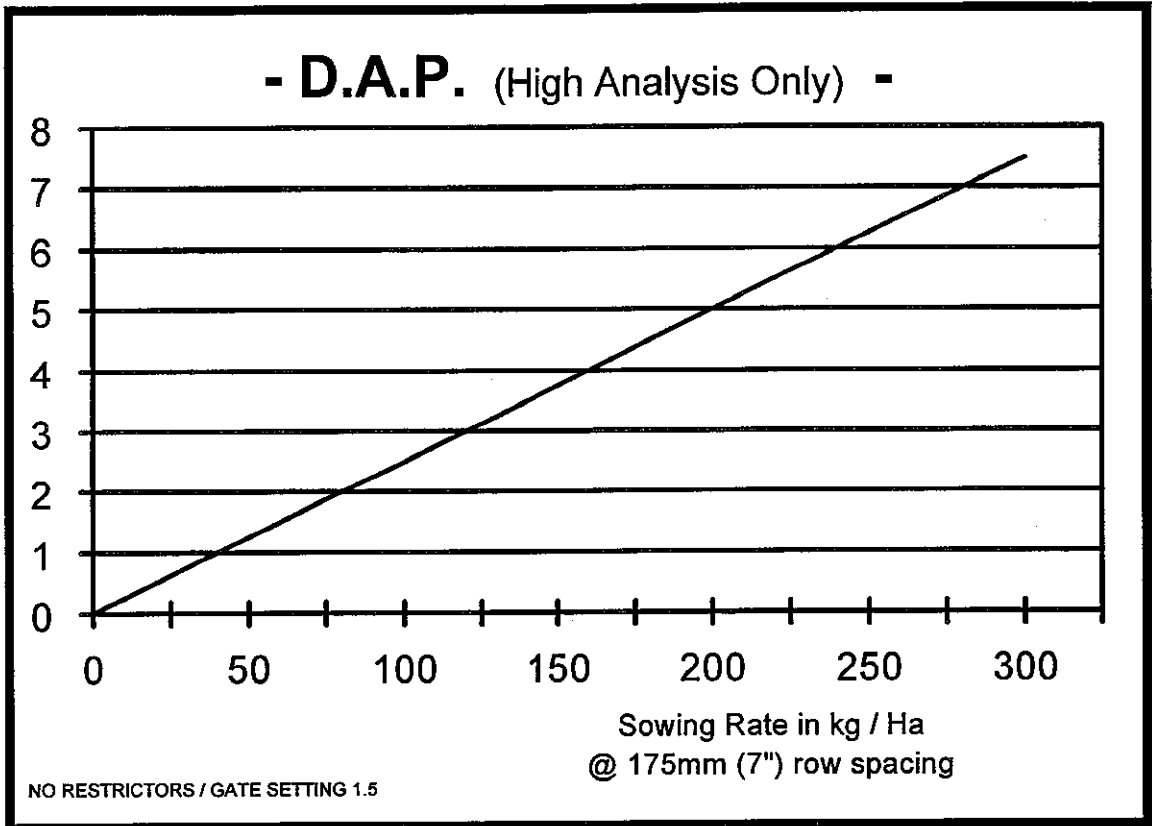
Correctly calibrating the Agrowdrill at each change of seed, fertiliser or application rate will prevent any undesired metering rates. The calibration procedure is outlined in section 6.5.

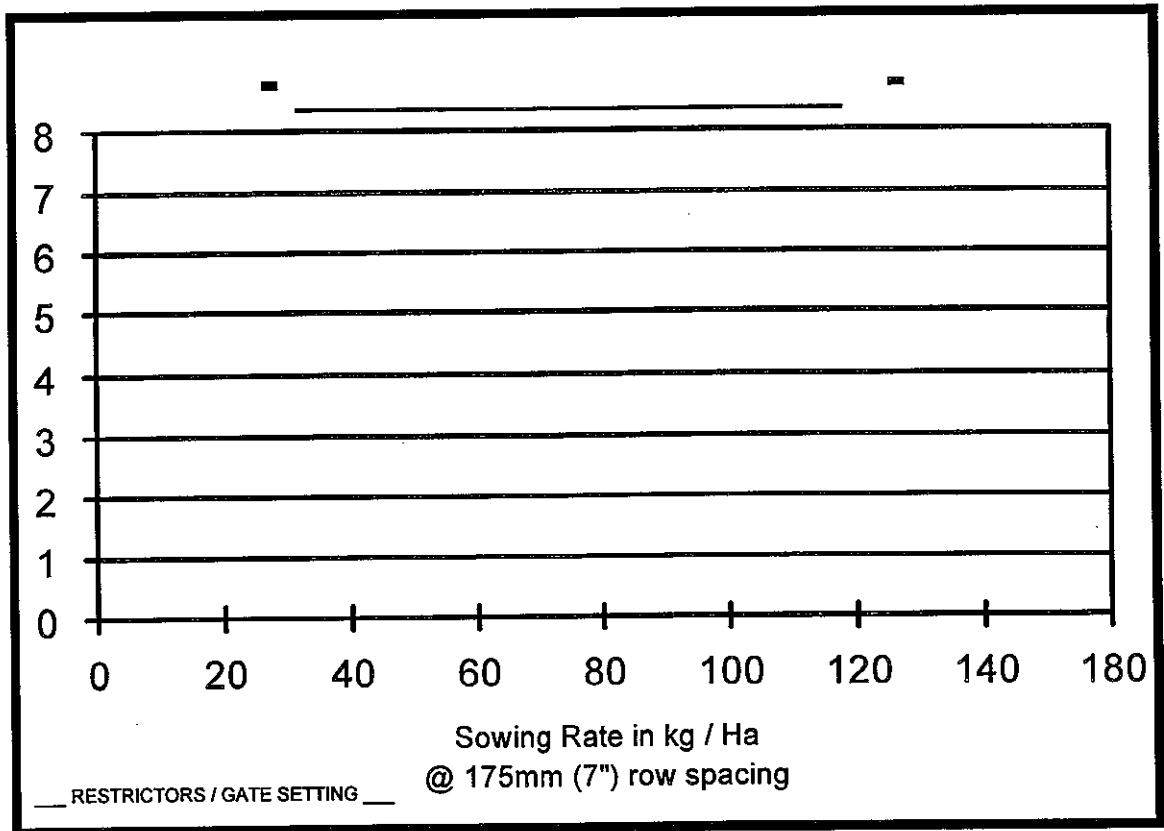
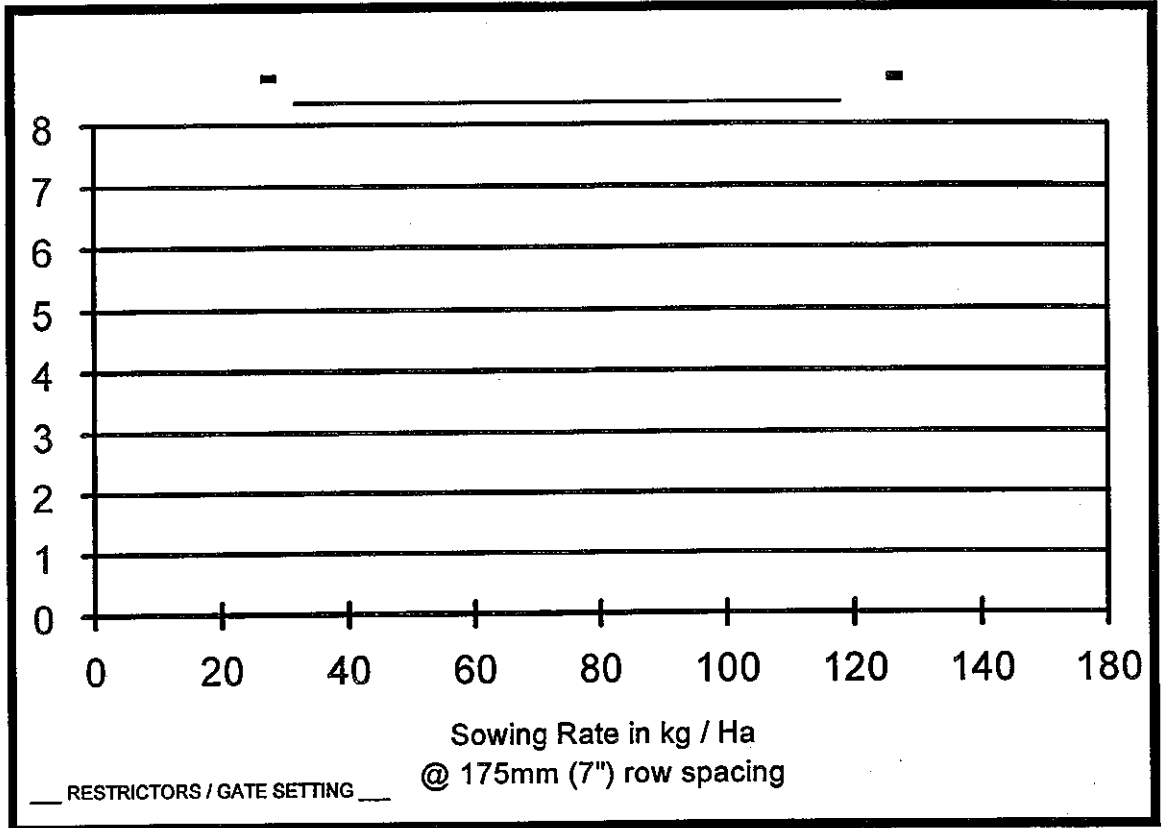


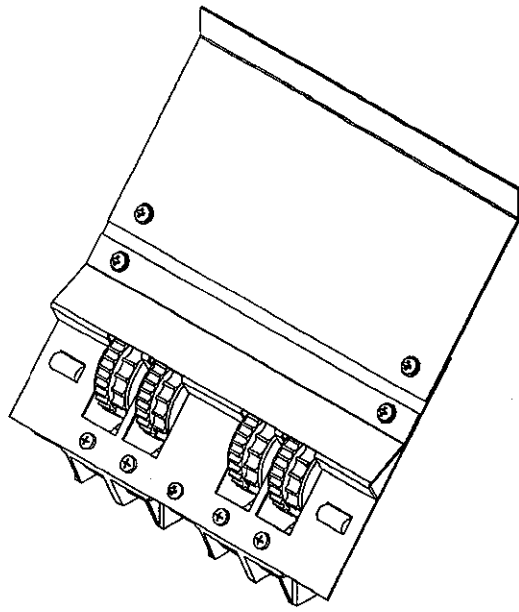




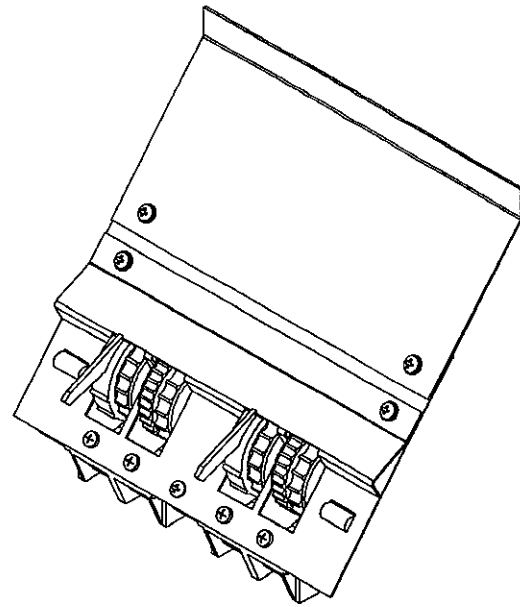




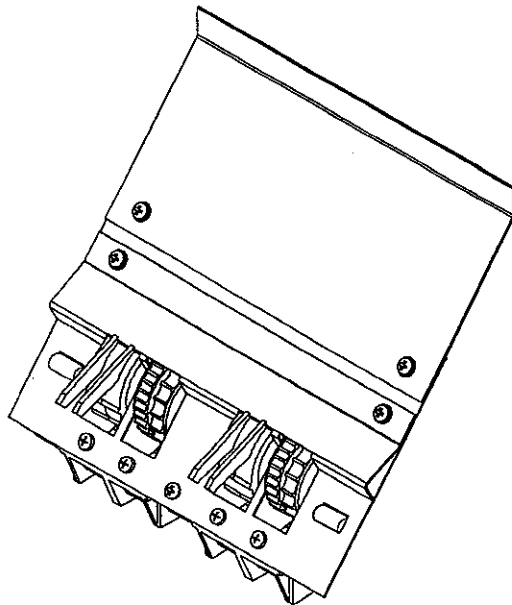




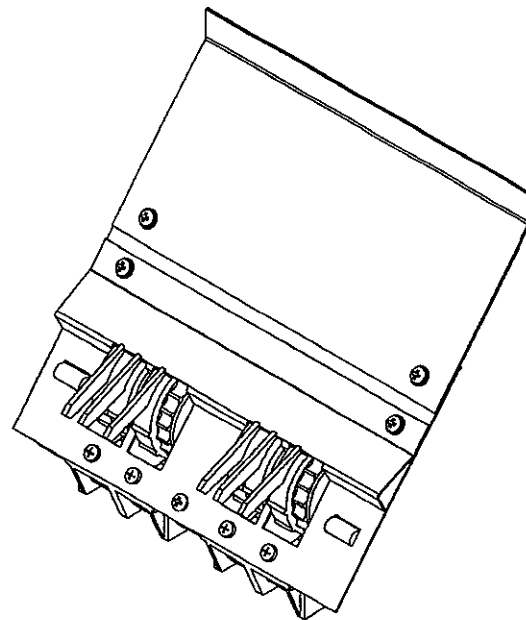
No Restrictors



One Restrictor



Two Restrictors



Three Restrictors

Figure 6.5: Restrictor Positioning

6.10 Agrowdrill Calibration Settings

The following table provides a guide to the correct calibration factors for the JPC 2000 Agrowdrill. For accuracy it is recommended that the procedure outlined in Section 6.5.1 be followed for calibration.

These settings are for the standard row spacing only and are based on an 18.4 x 34 tyre size.

Machine Size	No. of Rows	Row Spc. mm	Sowing Width	Wheel Rev/Ha.	idle shaft Rev/Ha.	distance to travel Ha.	FarmScan Pulse Dist.	Kee Circ. Dist.	No. Hoses	No. Turns	Multiply By kg / Ha
20 Row	20	175	3.500	570.25	1117.25	2857.25	2557	255.7	5	22.25	0.200
24 Row	24	175	4.200	475.25	931.00	2381.00	2557	255.7	5	18.50	0.240
28 Row	28	175	4.900	407.50	798.25	2040.75	2557	255.7	5	16.00	0.280
32 Row	32	175	5.600	356.50	698.50	1785.75	2557	255.7	5	14.00	0.320
36 Row	36	175	6.300	317.00	621.00	1587.25	2557	255.7	5	12.50	0.360

7.0 Operating Tips

7.1 After the First Round

The following is a list of points that should be checked after the first pass or round of a paddock:

1. Ensure both the seed and fertiliser drives are rotating.
Note: Problems in this area can be avoided with adequate maintenance and checking the rotation of the drives before commencing.
2. Check that the seed and fertiliser are running evenly through all rows.
3. Ensure that the bottoms of the delivery tubes are not blocking up with wet soil. If this occurs the soil should be allowed to dry before continuing.
4. Check the soil openers for any loose bolts.
5. Check the machine for any loose bolts.
6. Retension all tyne clamps.

7.2 Gradual Slowing of Fertiliser Flow

This often happens when using fertilisers such as single super that have a high percentage of fine powder. The powder generally builds up at the bottom of the fertiliser hopper and slows the flow rate. This may also occur with lime-coated seeds, as the lime is prone to flaking off.

To avoid this problem, occasionally run the fertiliser hopper to a low level and clear away any powder build up manually by opening the gate settings to the widest setting. Only do this while the machine is stationary.

7.3 Seizing of the Metering System

This can easily happen when using highly soluble and corrosive fertilisers such as urea. Such fertilisers will 'cake' rapidly in moist conditions and may seize the fluted rollers.

This can be avoided by never leaving the Agrowdrill filled with fertiliser or seed in moist conditions.

7.4 Checking the Rotation of the Drives

The rotation of the seed and fertiliser metering mechanism can be easily checked by 'ratcheting' the Varibox adjustment levers. Simply loosen the knurled knobs and move the lever backwards and forwards a number of times. This will rotate the drives allowing the following to be done:

- Check if the metering system is seized with 'caked' fertiliser.
- Free small blockages caused by 'caked' fertiliser. If the 'caking' is severe the hopper may need to be cleaned out manually.
- Check for blockages in the fluted rollers, delivery tubes or soil openers.
- The quantity of seed and fertiliser under each opener should be observed to ensure equal metering of seed and fertiliser across the width of the machine.

7.5 Cleaning Seed and Fertiliser Hoppers

Thorough cleaning of the seed and fertiliser hopper is very important for a number of reasons including:

- Fertiliser left in the hopper will cause corrosion of the metal parts of the Agrowdrill.
- If you are changing to a different seed all the previous seed must be removed to prevent contamination.
- Seed left in the Agrowdrill will attract mice, rats and insects.

The following is the procedure for cleaning:

1. Try to have as little seed or fertiliser as possible remaining after finishing the seeding.
2. Scrape all the remaining seed or fertiliser to one side and scoop into bags or buckets. Sweep the bottoms of the hoppers clean with a broom.
3. Remove all restrictors and open the gates under the fluted rollers. For end of season cleaning remove verandahs to allow easier cleaning.
4. Use an air compressor or water hose to blow or wash out any remaining seed or fertiliser. A vacuum cleaner used to suck out remaining seed or fertiliser also works well.
5. Close the gates under the fluted rollers and reinstall the restrictors into the desired location. Replace the verandahs.
6. Clean away any seed or fertiliser that may have spilled onto the frame of the Agrowdrill.

Note: If the Agrowdrill is washed with water allow the hoppers to dry out thoroughly by placing the Agrowdrill in the sun with the hopper lids open.

When the Agrowdrill is clean and dry, apply a light coating of diesel to the insides of the hoppers to prevent any corrosion from fertiliser.

8.0 Lubrication and Maintenance

The Agrowdrill is an extremely robust and durable machine and will give many years of service with simple routine maintenance.

8.1 Pre-Operation Check

Check the following points before operation:

- Check all nuts and bolts are tight.
- Check tyne spacings are correct.
- Check all sowing hoses and tubes are unblocked and correctly positioned.
- Check all grub screws are tight.
- Check metering shafts are easily turned using the crank handle provided. The shafts should not be jammed or hard to turn.
- Check the Hectaremeter is installed correctly and functioning properly.

8.2 Daily Service

Before starting work each day the Agrowdrill should be carefully checked for the following:

- Loose soil opener mounting bolts. Tighten as necessary.
- Excessively worn soil openers. Replace as necessary.
- Bent or blocked down tubes. In rough or stony conditions down tube mounting brackets may bend. Straighten if possible or replace.
- Quick visual check of entire machine.

8.3 Lubrication

The lubrication schedule for the Agrowdrill is as follows:

Item	Action	Interval
Drive Chains	Apply Oil	20 Working Hours
Wheel Axle Bearings	Grease	100 Working Hours
Chains	Wash and Grease	200 Working Hours
Varibox	Check Oil	200 Working Hours
Varibox	Change Oil	3 Years

8.4 Replacing Soil Openers

You should replace soil openers when they wear past the tungsten tip or lose their point. Blunt tips or worn heels will reduce the digging efficiency and seed placement accuracy of the Agrowdrill.

The procedure for changing soil openers is as follows:

1. Place the Agrowdrill on a hard surface and lift to the highest position and secure using the ram safety stoppers.
2. Turn the tractor off.
3. Remove retaining bolts that attach the opener to the shank. Depending on the type of opener there may be one or two bolts.
4. Remove worn opener and any damaged bolts.
5. Install new openers and any bolts and tighten bolts firmly.

8.5 Downtube Assembly

Use the following procedure to service the down tube assembly:

1. Remove the rubber boot from the retaining lugs on the fluted roller housing.
2. Twist the bottom of the flexible tube off the seeding boot and remove the downtube assembly.
3. Screw out the flexible tube.
4. Replace the rubber boot or flexible tube as required. Ensure the new flexible hose is of similar length.

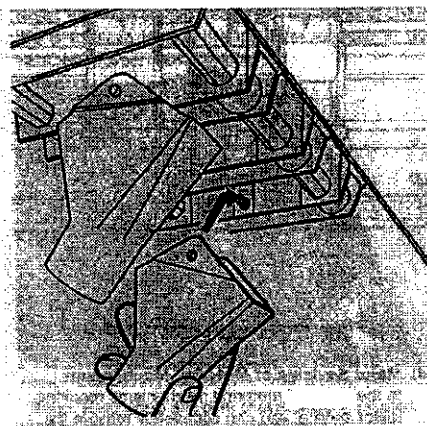


Figure 8.1: Removing outlet cups

8.6 Replacing Adjustable Gates

The adjustable gates are controlled by a hexagonal rod connected to the adjustment lever. Use the following procedure to replace worn or broken gates:

1. Remove the drive chain cover plate from the left side of the hopper.
2. Loosen the bolt that retains the gate adjustment lever.
3. Slide the hexagonal shaft out and remove worn or broken gates as required.
4. Slide the shaft back in assembling and replacing the gates as necessary.
5. Tighten the bolt that retains the gate adjustment lever.
6. Replace the drive chain cover plate.

8.7 Servicing the Fluted Rollers

The fluted rollers are driven by hexagonal shafts through the drive chains and sprockets on the left side of the Agrowdrill. These shafts are supported by self-aligning ball bearings adjacent to the sprockets and by glass filled nylon bushes mounted between every third outlet.

Servicing procedures are as follows:

8.7.1 Drive Sprocket Bearings

1. Remove the drive chain cover.
2. Remove the drive chain.
3. Remove the grub screws that retain the drive sprocket and slide the sprocket off the end of the shaft.
4. Loosen the grub screw retaining the bearing locking collar and rotate the collar to release the bearing.
5. Remove the two retaining bolts from the bearing housing and slide the bearing off the end of the shaft.
6. Replace the bearing and reinstall, reversing the above procedure.

8.7.2 Fluted Rollers

1. Remove the drive chain cover and drive chain.
2. Remove the two mounting bolts from the self-aligning bearing.
3. Pull the drive shaft out. In most cases it won't be necessary to remove the shaft completely. Only slide the hexagonal shaft far enough to reach the worn or damaged rollers.
4. Replace rollers as necessary and reverse the above procedure to reassemble.

8.7.3 Drive Shaft Mounting Bushes

The Agrowdrill is fitted with glass filled nylon bushes between every third row. These bushes require no lubrication, are extremely wear resistant and should last the life of the machine.

Use the following procedure if service is needed:

1. Remove the fluted roller shaft as outlined in the above section.
2. Remove the retaining bolt from the worn or damaged bush and replace the bush.
3. Reinstall the drive shaft.

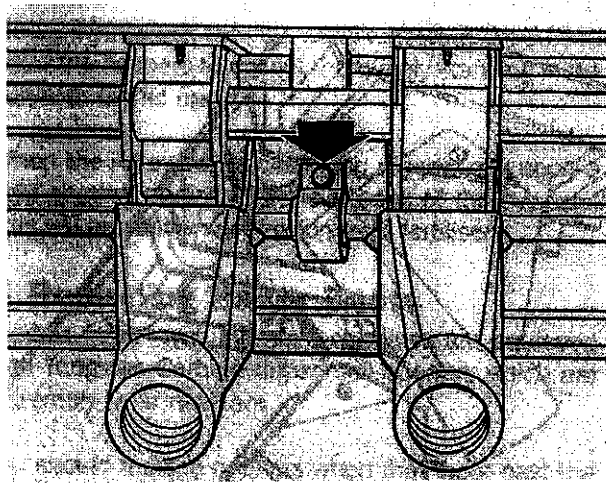


Figure 8.2: Drive shaft mounting bushes

8.8 Major Servicing of the Metering Mechanism

In the event of the metering mechanism requiring major servicing the bottom of the hoppers can be completely removed.

1. Remove the down tube assemblies and fluted roller drive sprockets and bearing assembly as outlined in previous sections.
2. Remove all restrictors.

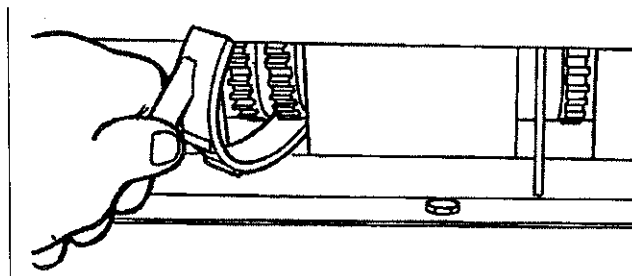


Figure 8.3: Removing and installing restrictors

3. Remove the retaining bolt from the front and rear of each fluted roller assembly and lower the entire metering mechanism from the bottom of the hoppers.
4. Installation procedure is the reverse of the above. The ends of the metering assembly will need to be resealed with a quality silicone sealant.

8.9 Servicing the Gearboxes

The Agrowdrill varibox gearbox requires no maintenance apart from an annual oil level check and an oil change every three years.

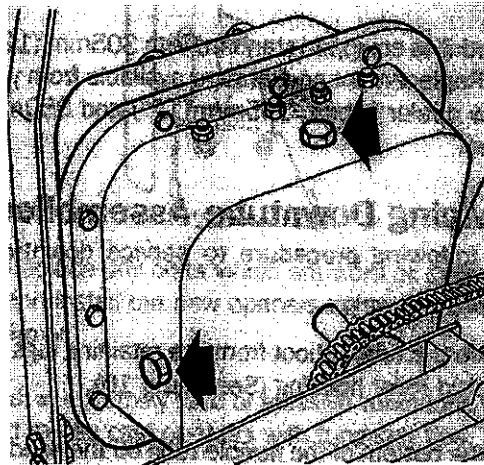


Figure 8.4: Varibox oil level and filler plugs

8.10 Drive Chain Adjustments

Chain tensioners are provided in the drive wheel arm, the chain to the gearbox and the chains to the metering mechanism. All chains should be adjusted until there is between 5mm and 10mm deflection of the chain with a light hand pressure applied. The longer the chain the greater the chain deflection that is allowed.

The primary drive chain in the wheel arm is fitted with nylon tensioning pads. The procedure to adjust for chain wear is as follows:

1. Loosen the nyloc nut on the tensioning pad.
2. Move the pad up or down until the desired chain tension is achieved.
3. Retighten nyloc nut.
4. If the chain tension is still insufficient a link may need to be added or removed from the chain.

8.11 Drive Chain Maintenance

The drive chains will benefit from some form of lubrication. The two recommended methods are:

- Oil chains regularly during seeding using a quality chain oil.
- Remove the drive chains annually and store them in a pot of quality chain oil.

Note: The most crucial measure to ensure long chain life is to avoid leaving the Agrowdrill exposed to the weather between seeding jobs.

8.12 Hectaremeter Sensor and Cable

Check the function of the Hectaremeter sensor and cable by the following procedure:

1. Switch the Hectaremeter on.
2. Check that the H1 and H2 calibration factors are entered correctly.
3. Press SPEED key. Display should read 0.0.
4. Disconnect sensor from cable, at the sensor itself.
5. Use a pair of long nose pliers and intermittently short the pins of the connecting plug on the cable together. The speed readout should show random numbers. If the speed readout responds, reconnect sensor.
6. If no response, reconnect sensor and repeat test at tractor breakaway plug (if used). If at this point the speed responds, then the cable between the breakaway plug and the sensor is faulty and will need replacing.
7. If still no response at the tractor breakaway plug repeat the test directly into the Hectaremeter unit itself.
8. If no response is registered at this point return the Hectaremeter unit to the nearest Farmscan dealer or authorised service agent.

8.13 Hectaremeter Multimeter Test

8.13.1 Reed Type Sensor

If the Hectaremeter is malfunctioning the reed type sensor can be checked using the following procedure:

1. Disconnect cable from sensor.
2. Rotate the shaft so that the magnet is as close as possible to the sensor.
3. Measure the resistance of the sensor using a multimeter. It should be a short circuit (ie the multimeter shows infinity).

4. Rotate the shaft so that the magnet is as far away as possible from the sensor.
5. Measure the resistance of the sensor using a multimeter. It should be an open circuit (ie the multimeter shows zero).

8.13.2 Sensor Cable

Check the function of the sensor cable using the following procedure:

1. Disconnect Hectaremeter and Sensor from sensor cable.
2. Place a sturdy wire link across the two terminals at the Hectaremeter end of the cable.
3. Measure the resistance across the two terminals at the sensor end using a multimeter. It should be a short circuit.
4. If it is short circuit, check that any breakaway connections are clean and connect firmly. If loose use a small object to close the female connection slightly.
5. Physically inspect cable for damage as it may have been crushed or cut.

8.14 End of Season Storage

To ensure a long and trouble free working life please take the following steps when storing the Agrowdrill for long periods.

- Clean out the hoppers thoroughly according to the procedure outlined in section 7.5.
- Shed the Agrowdrill for protection against the weather.
- Ensure chains are properly oiled and covered before storage or remove chains and store them in an oil bath.
- Ensure all grease nipples are thoroughly greased before storage. By excluding air and moisture from inside the bearings the chance of corrosion will be minimised. For best results grease the bearings while they are still warm from the last working.



**SIMPLE ROUTINE
MAINTENANCE WILL
PROLONG THE LIFE OF
THE JPC 2000 SERIES
AGROWDRILL**

9.0 Trouble Shooting Guide

9.1 Underframe

The Problem	Possible Cause	Possible Solution
Poor penetration	Soil is too dry	<ul style="list-style-type: none"> • Wait for rain or irrigate
	Insufficient weight	<ul style="list-style-type: none"> • Keep hoppers full • Fill tyres with water to add weight
	Machine not level	<ul style="list-style-type: none"> • Adjust levelling tube to suit
High soil opener wear	Soil is too dry	<ul style="list-style-type: none"> • Wait for rain or irrigate
	Working too deep	<ul style="list-style-type: none"> • Raise Agrowdrill to shallower depth
	Highly abrasive soil	<ul style="list-style-type: none"> • Use tungsten tipped points
	Machine not level	<ul style="list-style-type: none"> • Adjust levelling tube to suit
Tyres 'laying back'	The soil is too dry and hard	<ul style="list-style-type: none"> • Wait for rain or irrigate
	Machine not level	<ul style="list-style-type: none"> • Adjust levelling tube to suit
	Working too fast	<ul style="list-style-type: none"> • Slow to a suitable speed

The Problem	Possible Cause	Possible Solution
Too much surface disturbance	Not working deep enough	<ul style="list-style-type: none"> • Adjust deeper
	Working too fast	<ul style="list-style-type: none"> • Slow to a suitable speed
Too deep on one side	Incorrect depth setting	<ul style="list-style-type: none"> • Adjust depth stoppers evenly
	Low depth wheel pressure on one side	<ul style="list-style-type: none"> • Inflate to recommended pressures
	Low tractor tyre pressure	<ul style="list-style-type: none"> • Inflate as recommended in tractor manual
Machine blocking up with trash	Too much trash	<ul style="list-style-type: none"> • Graze heavily before seeding <ul style="list-style-type: none"> • Slash paddock • Control weeds before seeding
	Wet Conditions	<ul style="list-style-type: none"> • Allow soil and trash to dry
	Tynes too close	<ul style="list-style-type: none"> • Adjust spacing to wider setting
	Misalignment of tynes	<ul style="list-style-type: none"> • Adjust tyne spacing to correct alignment • Replace any bent or twisted tynes
Blocked downtubes or seeding boots	Mud build up	<ul style="list-style-type: none"> • Clean blockage and wait for drier conditions
	Insect or rodent nests	<ul style="list-style-type: none"> • Remove downtube and clean • Prevent mice or insect infestations
	Kinked downtube	<ul style="list-style-type: none"> • Repair or replace • Avoid conditions where tubes may be damaged

9.2 Metering System

The Problem	Possible Cause	Possible Solution
Falling fertiliser rate	Powder build up in hopper	<ul style="list-style-type: none"> • See 'Operating Tips' section
	Caking	<ul style="list-style-type: none"> • See 'Operating Tips' section
Incorrect metering rates	Different seed or fertiliser than that used to calibrate the Agrowdrill	<ul style="list-style-type: none"> • Recalibrate
Some rows not metering	Blocked roller	<ul style="list-style-type: none"> • Clean out hopper and unblock
	Stripped roller	<ul style="list-style-type: none"> • Replace roller
	Fertiliser clods in hopper	<ul style="list-style-type: none"> • Clear blockages
Some rows metering too quickly	Restrictor cap missing	<ul style="list-style-type: none"> • Clean out hoppers and check location of restrictors
	Broken adjustable gate	<ul style="list-style-type: none"> • Replace gate
Self feeding seed or fertiliser	Gate settings too wide	<ul style="list-style-type: none"> • Close up gate setting
	Restrictor caps not in place	<ul style="list-style-type: none"> • Clean out hopper and check location of restrictor caps
	Damaged gate	<ul style="list-style-type: none"> • Replace gate

The Problem	Possible Cause	Possible Solution
Failure to meter seed or fertiliser	Sprockets loose on shaft	<ul style="list-style-type: none"> • Tighten or replace grub screw on sprockets
	Gearbox broken	<ul style="list-style-type: none"> • Replace gearbox
	Chain dismantled	<ul style="list-style-type: none"> • Check alignment
		<ul style="list-style-type: none"> • Check condition of chain
Broken drive chains	<ul style="list-style-type: none"> • Replace chain 	
Broken Chain	Chain misalignment	<ul style="list-style-type: none"> • Realign chain
	Worn chain	<ul style="list-style-type: none"> • Replace chain
	Incorrect chain tension	<ul style="list-style-type: none"> • Retension chain
	Seized shafts	<ul style="list-style-type: none"> • Grease bearings • Clean metering system • Remove spilled fertiliser

Notes:

9.3 Hydraulics

The Problem	Possible Cause	Possible Solution
Uneven lift	Hydraulics not primed	<ul style="list-style-type: none">• Prime hydraulic system
Poor lift response	Air in hydraulic hose	<ul style="list-style-type: none">• Bleed air from system
	Low oil level in tractor	<ul style="list-style-type: none">• Add oil according to tractor operation manual

Notes:

9.4 Hectaremeter

The Problem	Probable Cause / Remedy
No response from ON/OFF switch	<ul style="list-style-type: none"> • Check that power cable connections at battery are clean and tight • Measure voltage from power cable at monitor connection point. It should be between 12 – 13.8 V DC • If voltage ok and unit fails, return to nearest Farmscan dealer or authorised service agent.
Hectaremeter total wrong	<ul style="list-style-type: none"> • Check that calibration factors H1 and H2 are correct • Is the machine overlapping or underlapping? • Is the unit counting headlands? • Switch to SPEED readout and make sure it is reading at a constant speed. Cable or sensor could be damaged if readout is jumpy. • Is the magnet facing the sensor end to end? • Is the correct magnet being used? • Is the magnet too far away from the sensor? (3-5mm gap) • Is the magnet staying in line with the sensor on corners? • Is the wheel loose? • Is the sensor on a non-driven wheel? Tractor drive wheels will cause an over reading. • Replace wheel / shaft sensor if none of the above.
Decimal point will not flash	<ul style="list-style-type: none"> • This is normal if TOTAL hectares are above 999.9, or it is extremely cold.
Hectare or Speed does not work	<ul style="list-style-type: none"> • Speed must be above 2.0km/h to register. • Check that the calibration factors H1 and H2 are correct. • Check that magnet and sensor are correct with correct gap (3-5mm)
Trip or Total Hectares fail to reset	<ul style="list-style-type: none"> • Press TOTAL or TRIP key first to select area to be cleared. • RESET key must be pressed and held down for at least 3-4 seconds • If hectares still fail to reset, return unit to nearest Farmscan dealer or authorised service agent.

The Problem	Probable Cause / Remedy
<p>Hectares count up on their own without moving</p> <p>or</p> <p>Calibration figures keep changing</p>	<ul style="list-style-type: none"> • Switch off all other electronics to eliminate electrical interference as the cause. <p>If switching off electronic eliminates the fault, ensure the Hectaremeter cables are not running alongside wiring from other electrical devices, and / or physically move the Hectaremeter in relation to the other equipment.</p> <ul style="list-style-type: none"> • If petrol engine in close proximity, stop the engine to see if interference is caused by ignition system. Note: Carbon ignition leads must be fitted to spark plugs and coil to stop interference. • Disconnect Sensor from cable at wheel / shaft. If the problem stops, replace the sensor. • Make sure the Hectaremeter has an independent power cable, wired directly to the battery + and – terminals. • If unit still counts hectares, return unit to nearest Farmscan dealer or authorised service agent.

Notes:

