

FARMSCAN | jackalv2

one monitor,
many possibilities



area meter
batch meter
tacho meter
rate monitor
spray monitor
pressure monitor
surveillance monitor
wheel slippage monitor



TABLE OF CONTENTS

General Description _____	1	Available Connections (Refer Page 3) _____	12
Technical Specifications _____	1	Setup _____	12
Disclaimer _____	1	Flow Meter (Wizard) _____	13
Installation _____	2	Description _____	13
Parts List _____	2	Sensors Required _____	13
Parts Pictorial _____	2	Available Connections (Refer Page 3) _____	13
Mounting & Installation _____	2	Setup _____	13
Connections _____	3	Calibration _____	13
Available connections _____	3	Option 1 : Target Method (auto cal with a known volume) _____	13
Power Connection _____	4	Option 2 : Manual Ratio (Enter a known PPL/PPG factor) _____	13
Overview _____	5	Calibration (Continued) _____	14
Button Functions _____	5	Slippage Meter (Wizard) _____	15
Screen Layout _____	6	Description _____	15
More information on screen _____	6	Sensors Required _____	15
Main Menu (Setup Overview) _____	7	Available Connections (Refer Page 3) _____	15
Using the Wizard _____	8	Setup _____	15
Area & Speed Meter Setup (Wizard) _____	9	Calibration _____	15
Description _____	9	User Defined Setup (Manual) _____	16
Sensors Required _____	9	Description _____	16
Available Connections (Refer Page 3) _____	9	Inputs _____	17
Setup _____	9	Front Screen _____	18
Calibration _____	9	Front Screen – Order _____	19
Option 1 : Target Method _____	9	Other Settings _____	20
Option 2 : Manual Ratio _____	9	Output _____	21
Calibration (Continued) _____	10	GPS/Serial _____	22
Area & Speed GPS (Wizard) _____	11	Trips (Explained) _____	23
Description _____	11	Description _____	23
Sensors Required _____	11	Setup _____	23
Available Connections (Refer Page 3) _____	11	Alarm _____	24
Setup _____	11	Description _____	24
Tacho/RPM Meter Setup (Wizard) _____	12		
Description _____	12		
Sensors Required _____	12		

GENERAL DESCRIPTION

The Jackal is capable of monitoring multiple functions simultaneously – e.g. In a 4 bin / tank Airseeder application a single Jackal can monitor and display several shafts, bin levels, air pressure and more.

There are a total of 14 inputs available which are combined with a single output for emergency shutdown, batching functions and speed proportional pulse outputs.

The inputs can have both high and low alarm thresholds set which can trigger emergency shutdown systems.

The unit employs a large daylight readable LCD to provide legible characters on the display and enable calibration data to be clear and descriptive.

Up to 14 values can be displayed or used as totals, with up to 24 recordable trips allowing the operator to track numerous jobs in a period of work. The Jackal can be put 'on hold' by the operator or by a suitable signal from the machinery, so that periods of machine operation that should not accumulate as a work total can be excluded from trip totals.

Our onboard calibration wizard makes setup a breeze! It's simplified with the ability to enter either a factor (pulses per unit) or simply drive/run a set amount whilst the unit is counting the pulses and let the system calculate its own factor.

Each input can be used to display information using imperial and metric units.

TECHNICAL SPECIFICATIONS

Power Requirements	9 – 16 VDC @ 250mA
Display	128 x 64 Mono Graphic LCD
Operating Temperature	0 to 50C
Storage Temperature	-5 to 65C
Dimensions	135mm x 100mm x 30mm
Sensor Inputs	13
Input 1	Up to 1000 pulses per second.
Inputs 2 – 6	Up to 400 pulses per second.
Inputs 7 – 8	Analog Voltage 0 – 5V
Inputs 9 – 13	On/Off: 0V or 12V
Outputs	1
Output 1	Low side drive 3A maximum load.

DISCLAIMER

The warranty offered on this Farmscan AG product is limited to the repair or replacement of the faulty goods. No liability will be accepted for loss of profit or productivity. **WARRANTY IS VOID** if power is not connected as described on **PAGE 6**.

INSTALLATION

PARTS LIST

REF	PART NUMBER	DESCRIPTION	QTY
1	A-Jackal	Jackal Monitor	1
2	AH-407	Mounting Bracket	1
3	P-321	11 Way Input Plug Green & Grey set	1each colour
4	AC-105	5m Power Cable	1
5	HM-506	Screw Driver	1
	AM-200	Warranty Card	1
	AM-Jackal	Manual	1

PARTS PICTORIAL



MOUNTING & INSTALLATION

The Jackal is provided with a suction window mount.

Slide mount onto unit and push sideways to lock into place. Make sure you hear a click of the mount locking into place.

Place in a convenient position on the windscreen and using the toggle lever pictured, push all the way to the bottom until lever locks into position.

Note: Monitor should be mounted in a clearly visible position in the cab for the operator, but not in a position where it is subject to intense heat or moisture.

CONNECTIONS

The connector on the rear of the Jackal has the following connection points available for use.

AVAILABLE CONNECTIONS

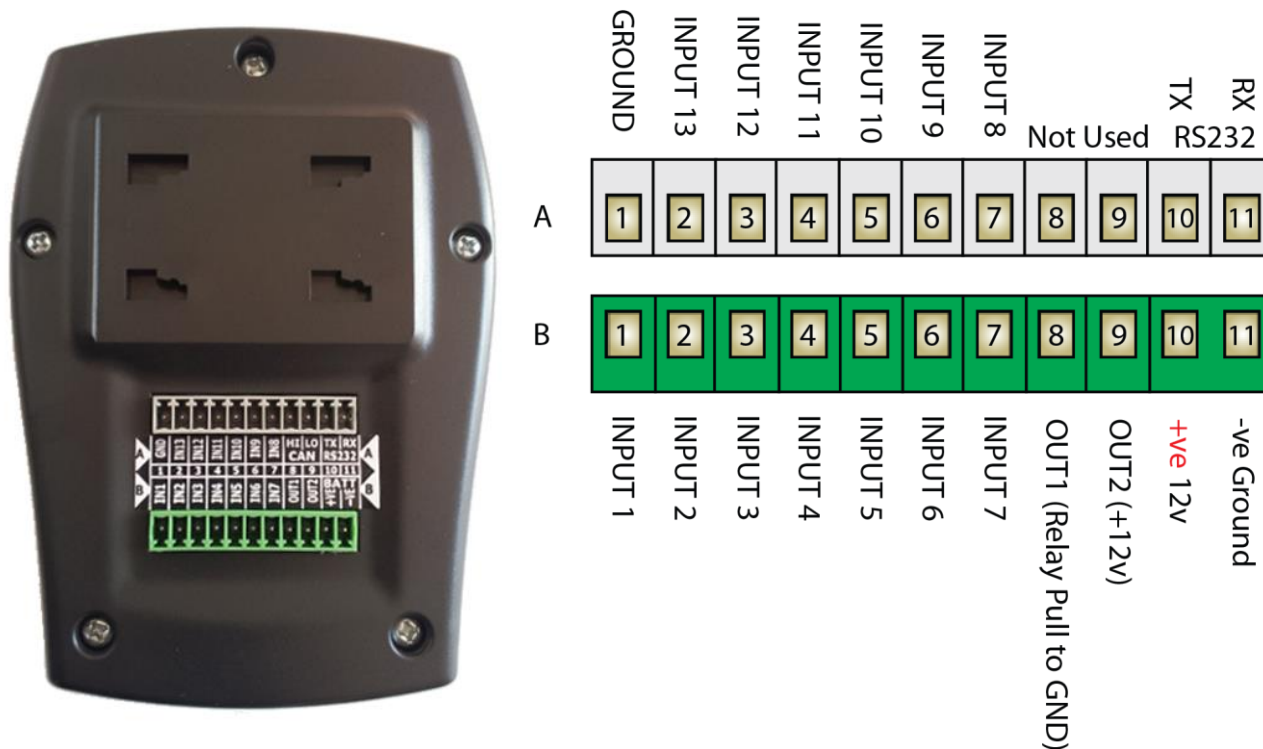

A1	GND (Ground/Earth/0V)	B1	IN1 (1x Coil Input ONLY /Prox/Reed sensor)
A2	IN13 (Prox/Reed/Switch/Alarm)	B2	IN2 (Prox/Reed/Switch/Alarm)
A3	IN12 (Prox/Reed/Switch/Alarm)	B3	IN3 (Prox/Reed/Switch/Alarm)
A4	IN11 (Prox/Reed/Switch/Alarm)	B4	IN4 (Prox/Reed/Switch/Alarm)
A5	IN10 (Prox/Reed/Switch/Alarm)	B5	IN5 (Prox/Reed/Switch/Alarm)
A6	IN9 (Prox/Reed/Switch/Alarm)	B6	IN6 (Prox/Reed/Switch/Alarm)
A7	IN8 (Varying volt sensor)	B7	IN7 (Varying volt sensor)
A8	Not Used	B8	Out1 (Solenoid/Shutoff/Pulse/Radar output) – Pulls to GND
A9	Not Used	B9	Out2 (+12V Supply Out) – Sensor Power ^^
A10	RS232 Tx (Transmit)	B10	BATT +VE (+12V Battery Terminal)
A11	RS232 Rx (Receive)	B11	BATT -VE (0V/GND Battery Terminal, Vehicle Ground)

- ^ B8/OUT1 is Open Circuit when the output is NOT ACTIVE, and is connected to GND when the output is active
- ^^ B9/OUT2 will only power the sensors when the unit is turned on
- Any Inputs 1-13 can be used as remote/run hold

POWER CONNECTION

Power connection must come direct from the battery terminals. **WARRANTY IS VOID** if power is not connected as described in this section.

1. Connect power cable supplied **DIRECTLY TO BATTERY**
2. Ring terminals are used for battery connection and the end with Ferrules attached is used to connect to the rear Jackal. (Refer page 3 for connection instructions)
3. Connect Ground to BATT -VE, **Terminal B11** using the **RED** with **BLACK** stripe wire
4. Connect **+12** Volts (+battery terminal) to BATT +VE, **Terminal B10** using the **red** wire
5. Ensure that the battery connection to the Jackal is **+12 Volts**

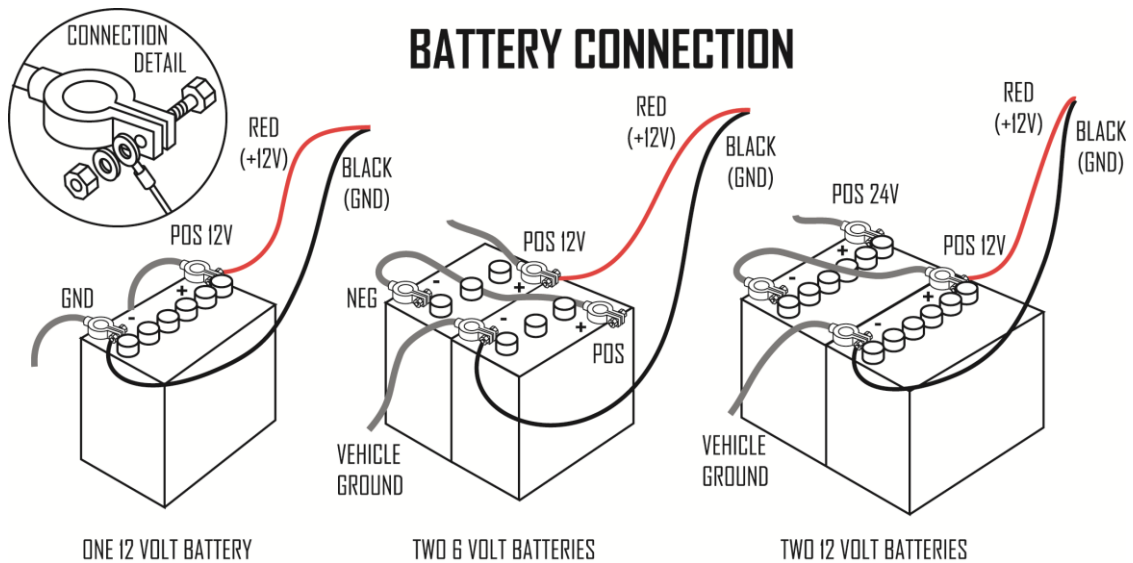

Disconnect the terminal plugs from the Jackal if **ARC WELDING** on machinery

Connecting 24V to the Jackal will **VOID WARRANTY**

OVERVIEW

BUTTON FUNCTIONS

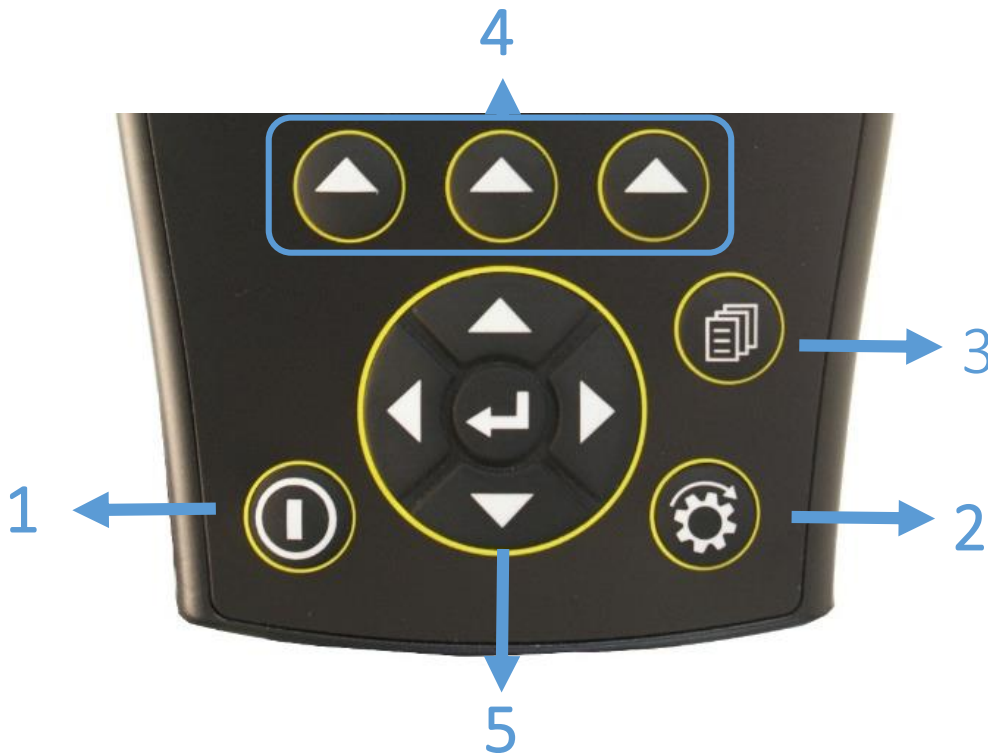

1. Power On/Off Key

- a. Power is turned on by a short press of the **ON/OFF** Key (1 second).
- b. Power is turned off by two (2) short presses.

2. Run/Hold Key

- a. The **RUN/HOLD** key has a dual function.
- b. Press **RUN/HOLD** once to place the 'MONITOR ON HOLD'.
- c. Press **RUN/HOLD** again to resume operation.
- d. The **RUN/HOLD** state is indicated in the top left hand corner of the screen. When the monitor is in RUN mode, the unit displays RUN to signify that the monitor is active.
- e. When the monitor is in **HOLD** mode the unit displays **HOLD**

3. Menu/Page Key

- a. The **MENU/PAGE** key is used for setting up the ports as well as returning to the main screen from **TRIPS** or **TOTAL** displays

4. Select Key (3 of)

- a. The Jackal has 3 soft keys placed directly under the LCD. These keys will change function in different menus.
- b. The function of the soft key is indicated at the bottom of the screen directly above the button.

5. Navigation Keys (Up, Down, Left, Right, Enter)

- a. The Round navigation (**NAV**) keys are used to navigate **UP/DOWN** & **LEFT/RIGHT** in calibration screens.
- b. **ENTER** is used to activate the selection

SCREEN LAYOUT

The main operation screens show live information and alarms, measured using the sensors attached to the Jackal.

The Jackal can display one (1), two (2) or three (3) pieces of live information at a time. If more than three pieces of information are available, the **MENU/PAGE** or **LEFT/RIGHT** can be used to cycle through the available information, as described below.



1 line of information (1 UP)
Example: Line 1 – RPM



2 lines of information (2 UP)
Example: Line 1 – Ha | Line 2 – km/hr



3 line of Information (3 UP)
Example: Line 1 – km/hr. | Line 2 – Ha | Line – 3 RPM

MORE INFORMATION ON SCREEN



When more than 3 lines of information are selected use:
MENU/PAGE or **LEFT/RIGHT** to cycle through the available information.

MAIN MENU (SETUP OVERVIEW)

Below is a generic overview of the main menu.

The manual will guide you through two (2) setup scenarios.

- a. **Wizard Setup**
- b. **Manual Setup**

FRONT SCREEN > SETUP



- Wizard** Allows the user to run a predefined wizard for setting up common task Area/Speed Wheel, Area/Speed GPS, TachoMeter, FlowMeter, Slippage Meter & Generic Wizard for fast setup.
- Inputs** Allows the user to select the ports in which sensors are connected to. A choice of 13 inputs are available
- Front Screen** Allows the user to enable/define/move/edit up to 13 line items on the front screen You can also name the input port, select the number of decimal places displayed & edit the alarms
- Other** Allows the user to set in implement width (m), External run/hold options & alarm notification **Settings** options
- Output** Allows the user to select output options from the Jackal. Output as a frequency / pulse (radar), external audible/visual alarm, batch/trip function, other external function if required.
- GPS/Serial** When an external gps is connected the user can view & ensure the gps is setup correctly. Setup baud rate & confirm gps messages (NMEA messages RMC or GGA+VTG are required) Latitude, Longitude, heading, speed, date & time
- About Jackal** Shows current version of Jackal software installed on the unit
- Factory Reset** Returns the Jackal to factory default. All settings & options cleared

USING THE WIZARD

FRONT SCREEN > SETUP > WIZARD

The Jackal has an inbuilt wizard function for common tasks.

Current Wizards include easy setup for:

- Area/Speed Wheel – Wheel pickup & sensor required
- Area/Speed GPS – No Wheel Sensor required GPS only
- TachoMeter (RPM)
- FlowMeter (Direct readout or batch)
- Slippage Meter (GPS v Wheel Input)
- Generic Wizard (You can choose the input, screen position & calibration factors)

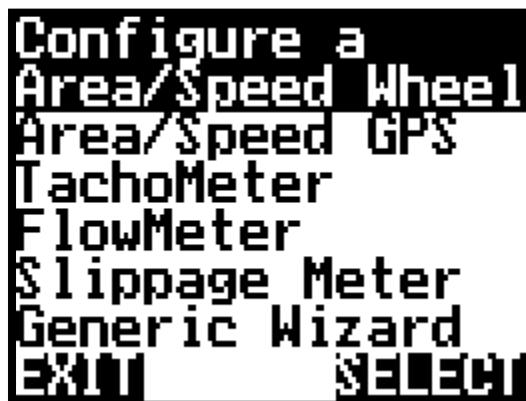

AREA & SPEED METER SETUP (WIZARD)

DESCRIPTION

The Jackal can display Speed & Area in any combination of km/mph or ha/acre. A pickup can be mounted either on a wheel hub or shaft.

SENSORS REQUIRED

- Wheel sensor pickup 2 or 3 wire
- Magnet (Used with 2 wire sensor)

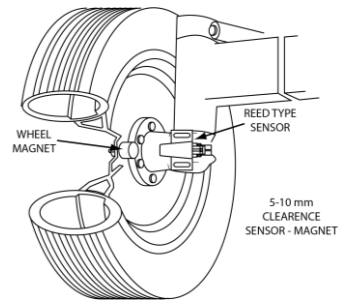

AVAILABLE CONNECTIONS (REFER PAGE 3)

This setup section assumes that physical wiring for the required sensors have been completed. If not please refer to page 3 on wiring requirements

SETUP

FRONT SCREEN>SETUP>WIZARD>AREA/SPEED WHEEL

1. Using the **NAV KEYS** select the current port the wheel sensor input is connected to & press **NEXT**
2. Press **EDIT** (to enable the port)
3. Using the **EDIT KEY** select your unit of pulse for calibration
 - M (Meter) | ft. (Feet) | yd.(Yard) | in (Inch) | km (Kilometer) | mi (Miles)

CALIBRATION

- Ensure that the sensor & pickup are end-end before continuing with either method
- Mark bottom centre of tyre on which the sensor is fitted and peg ground in corresponding position
- **CHOOSE CALIBRATION METHOD OF TARGET OR MANUAL RATIO AS DESCRIBED BELOW:**

OPTION 1 : TARGET METHOD

1. Measure out a known distance to calibrate i.e. 20m to use the auto calibrate function.
 - Peg the 2 corresponding points.
2. Enter the target distance by pressing the **EDIT** key i.e. 20
3. Press **EXIT** when done
4. Press the **START** button and move slowly forward to allow pulses to register.
5. When you arrive at the centre mark point of tyre to peg press **STOP**
6. Press **CALC**

OPTION 2 : MANUAL RATIO

1. Enter a known wheel factor (i.e. Wheel circumference)
2. Scroll down to the Manual Ratio (1.000000) and press the **EDIT** Enter the known wheel factor
3. Press **EXIT** when done
4. Select **NEXT**
5. Enter your implement Width **EDIT** in desired UOM (M,FT,YD,IN,KM,MI)
 - This will show covered area on the main screen
6. Scroll down to enable/disable the External/Run hold (*Refer page 3 for inputs*)
7. If the External/Run Hold is enable select the input port to where it is connected

CALIBRATION (CONTINUED)

4. Scroll down to Alarm Beep and **EDIT** the number of audible beeps to be heard on the selected port if an alarm sounds.
5. Select **NEXT**
6. Choose your units of display
 - Ha (Hectares) | Ac (Acres) | m² (Meters squared) | Km² (Kilometers squared)
7. Select **NEXT**
8. You can now **EDIT** the audible alarm points for a Min & Max range to be notified of a problem
9. Select **NEXT**
10. Create a name for your port if desired by pressing **EDIT**
11. Use the **UP/DOWN/LEFT/RIGHT** to change the letters. (Max 3 letters)
12. Select **EXIT** when done
13. Select **NEXT**
14. Confirm that you wish to display km/hr. or mph on the next line (**YES** or **NO**)
15. Select **NEXT**
16. Return to the front screen to confirm setup is complete by selecting **EXIT**

** Refer to page XX to edit decimal places, rename the port or change the unit of measure i.e. to mph, acres, m, ft

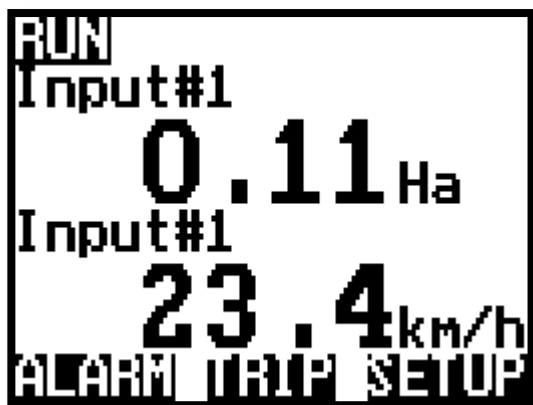

Example: Speed (km/h) & area meter

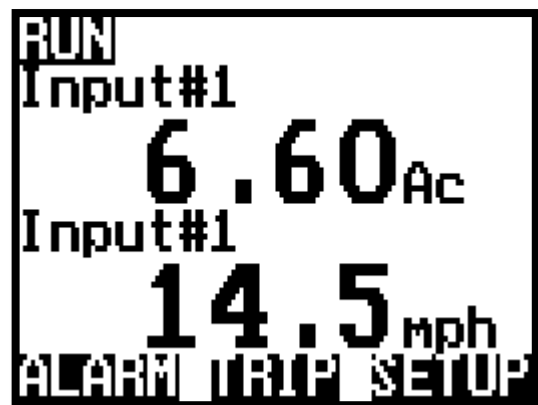

Example: Speed (mph) & acre meter

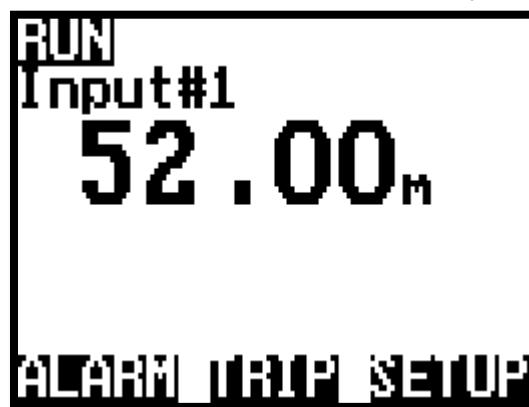

Example : Setup to measure distance

AREA & SPEED GPS (WIZARD)

DESCRIPTION

The Jackal can display Speed & Area in any combination of km/mph or ha/acre. A GPS can be used in place of a wheel or shaft pickup.



SENSORS REQUIRED

- GPS : Programmed with RMC or GGA+VTG NMEA messages.
- Baud Rate : 4800,9600,19200,38400,115200

AVAILABLE CONNECTIONS (REFER PAGE 3)

This setup section assumes that physical wiring for the required sensors have been completed. If not please refer to page 3 on wiring requirements.

SETUP

FRONT SCREEN>SETUP>WIZARD>AREA/SPEED GPS

1. Using the **EDIT KEY** select the baud rate of the attached GPS (4800,9600,19200,38400,115200)
 2. When the correct baud rate has been selected the NMEA messages will change from N (No) to Y (YES)
 3. Press **NEXT**
 4. Enter your implement Width **EDIT** in desired unit of measure (m,ft,yd,in,km,mi) – This will show covered area on the main screen
 5. Scroll down to enable/disable the External/Run hold (*Refer page 3 for inputs*)
 - a. Disabled | Normally off | Normally on
 6. If the External/Run Hold is enable select the input port to where it is connected
 7. Scroll down to Alarm Beep and **EDIT** the number of audible beeps to be heard on the selected port if an alarm sounds.
 8. Select **NEXT**
 9. Choose your units of display
 - a. Ha (Hectares) | Ac (Acres) | m² (Meters squared) | Km² (Kilometers squared)
 10. Select **NEXT**
 11. You can now **EDIT** the audible alarm points for a Min & Max range to be notified of a problem
 12. Select **NEXT**
 13. Create a name for your port if desired by pressing **EDIT**
 14. Use the **UP/DOWN/LEFT/RIGHT** to change the letters. (Max 3 letters)
 15. Select **EXIT** when done
 16. Select **NEXT**
 17. Confirm that you wish to display km/hr or mi/hr on the next line (**YES** or **NO**)
 - a. If **NO** is selected the Jackal will only display Ha or Acre
 18. Select **NEXT**
- Return to the front screen to confirm setup is complete by selecting **EXIT**



TACHO/RPM METER SETUP (WIZARD)

DESCRIPTION

The Jackal can display a RPM (Revolutions per minute) Useful for monitoring fans or shafts.

SENSORS REQUIRED

- Sensor pickup 2 or 3 wire
- Magnet for use with 2 wire or bolt head if using a proximity

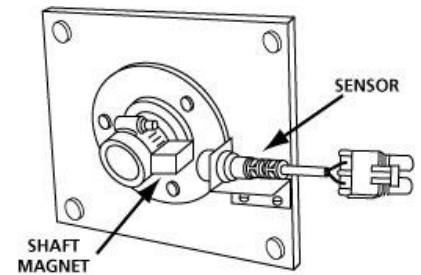

AVAILABLE CONNECTIONS (REFER PAGE 3)

This setup section assumes that physical wiring for the required sensors have been completed. If not please refer to page 3 on wiring requirements.

SETUP

FRONT SCREEN>SETUP>WIZARD>TACHOMETER

1. Using the **NAV KEYS** select the current port the sensor input is connected to & press **NEXT**
2. Press **EDIT** (to enable the port)
3. Using the **EDIT KEY** select **pulse/rev** (Pulse/Revolution)
4. Using the **NAV KEYS** scroll to **MANUAL RATIO 1.000000** & press **EDIT**
5. Enter the number of magnets or pickup location per revolution.
 - a. I.e. If 2 magnets are installed change 1 to 2
6. Press **EXIT** when done
7. Press **NEXT**
8. Select **1: rpm**
9. You can now **EDIT** the audible alarm points for a **Min & Max** range to be notified of a problem
10. Select **NEXT**
11. Create a name for your port if desired by pressing **EDIT**
12. Use the **UP/DOWN/LEFT/RIGHT** to change the letters. (Max 3 letters when in 3 up mode)
13. Select **EXIT** when done
14. Select **NEXT**
15. Select **EXIT** to return to the front screen to confirm setup

** Refer to page XX (Front Screen) to edit decimal places or to rename the port



Example: 1UP monitoring 1 shaft

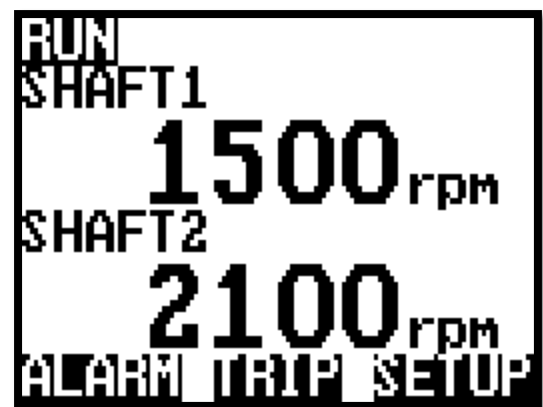

Example: 2UP monitoring 2 shafts

FLOW METER (WIZARD)

DESCRIPTION

The Jackal can be configured to monitor application rates of solid or liquid products. If only one input is used the main screen will display the flow information is L/min or Gal/min, or, if using the speed & area function the Jackal can also display L/ha or Gal/Acre. At no stage can the Jackal take into account multiple sections turning on an off and adjusting the Ha/Ac to suit.



SENSORS REQUIRED

- Flow Sensor (2 or 3 wire)

AVAILABLE CONNECTIONS (REFER PAGE 3)

This setup section assumes that physical wiring for the required sensors have been completed. If not please refer to page 3 on wiring requirements.

SETUP

FRONT SCREEN>SETUP>WIZARD>FLOWMETER

1. Using the **NAV KEYS** select the current port the flow sensor input is connected to & press **NEXT**
2. Press **EDIT** (to enable the port)
3. Using the **EDIT KEY** select your unit of pulse for calibration
 - L (Litres) | GAL (gallons US)

CALIBRATION

OPTION 1 : TARGET METHOD (AUTO CAL WITH A KNOWN VOLUME)

1. Scroll down to **TARGET** and press **EDIT**
2. Enter a known volume to calibrate the flow meter against. I.e. 20L or 5Gal.
3. Press **EXIT**
4. Start the pump, press **START** open the valve and pulses will now accumulate.
5. As SOON as the volume has been emptied press **STOP**
6. Press **CALC**, this will now enter the PPL/PPG factor into the Manual Ratio

```

Input 1 Edit
pulse/L
Auto Set:
Target:20.00L
Meas.pulses: 176
Manual Ratio:
8.800000
NEXT START EDIT
  
```

OPTION 2 : MANUAL RATIO (ENTER A KNOWN PPL/PPG FACTOR)

1. Scroll down to Manual Ratio
2. Press **EDIT**
3. Enter the known PPL/PPG factor as labelled on the flow meter
4. Press **EXIT**
5. Press **NEXT**

```

Input 1 Edit
pulse/L
Auto Set:
Target:0.000L
Meas.pulses: 0
Manual Ratio:
687.000000
NEXT EDIT
  
```

CALIBRATION (CONTINUED)

17. Choose your units of display : L/Min or Gal/Min Press **NEXT**
18. You can now **EDIT** audible alarm points for a Min & Max range to be notified of a problem
19. Press **NEXT**
20. Create a name for your port if desired by pressing **EDIT**
21. Use the **UP/DOWN/LEFT/RIGHT** to change the letters. (Max 5 letters)
22. Select **EXIT** when done
23. Select **NEXT**
24. Select **NEXT**
25. Return to the front screen to confirm setup is complete by selecting **EXIT**

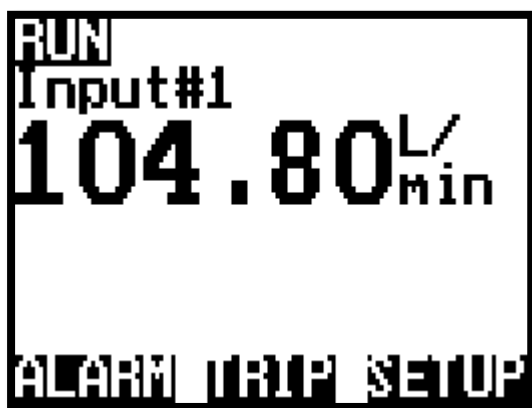

Example : 1 UP monitoring a flow meter in L/min



Example : 1 UP monitoring a flow meter in gal/min

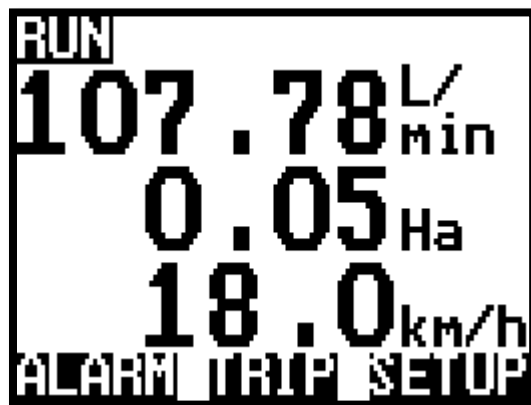

Example : 3 UP monitoring a flow in L/Min & Speed/Area with a wheel sensor connected

SLIPPAGE METER (WIZARD)

DESCRIPTION

The Jackal has been designed to provide the operator with the ability to compare and two inputs and provide the result as a percentage. This is applicable in industries such as agriculture when speed over ground is not necessarily equivalent to rotational speed of the wheel/s. This wizard will enable you to set up a comparison between wheel speed and actual speed (using GPS)

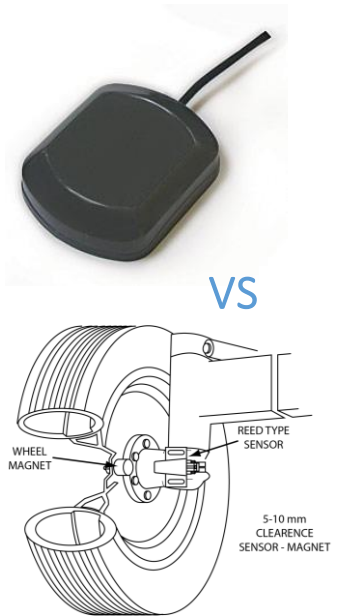

SENSORS REQUIRED

- Wheel or gearbox sensor input
- GPS

AVAILABLE CONNECTIONS (REFER PAGE 3)

This setup section assumes that physical wiring for the required sensors have been completed. If not please refer to page 3 on wiring requirements

SETUP

FRONT SCREEN>SETUP>WIZARD>SLIPPAGE METER

1. Using the **NAV KEYS** select the current port the wheel sensor input is connect to & press **NEXT**
2. Using the **EDIT** key, select the baud rate of the **GPS** that is connected.
 - a. GPS messages will be displayed on the Jackal monitor when the correct baud rate is chosen.
3. Press **NEXT**

CALIBRATION

1. Drive at a constant speed above 3km/hr.
2. Wheel input will then increment up (displayed in Hz) & GPS speed will start to show.
3. As the system self-calibrates the slip % will get closer to 0%.
4. When the slip has settled close to 0%press **NEXT**
5. EDIT the necessary alarm points to be notified of any alerts & select **NEXT**
6. The port by default is called "SLIP" & no need to be renamed. Press **NEXT**
7. You will now be prompted to "Configure next display to km/hr?" This will display slip % on the 1st of the Jackal & km/hr on the 2nd line. Select **YES** or **NO**
8. Wizard Configuration Successful , Select **NEXT**
9. Select **EXIT** to return to the main screen.

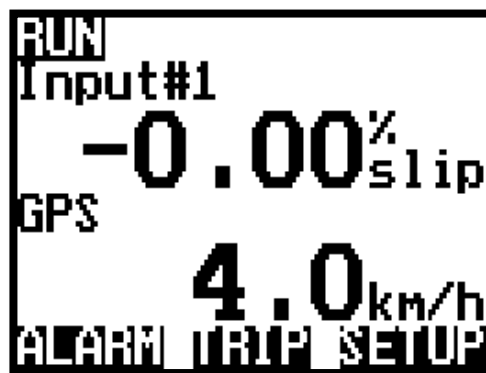

Example : 2 UP monitoring slippage versus ground speed displayed as a percentage

USER DEFINED SETUP (MANUAL)

DESCRIPTION

At any stage you can manually setup the Jackal to your requirements without using the wizard. Manual setup of the Jackal requires setup in multiple areas. Navigate from the front screen via **SETUP**

FRONT SCREEN > SETUP

INPUTS

Select & enable the Input that sensors are connected into the rear of the Jackal

CALIBRATE

Calibrate each input following the **TARGET** or **MANUAL RATIO** method

FRONT SCREEN

Define the order of lines, label, Unit of measure (UOM), decimal places & alarm points that you wish to be displayed on the front screen. NB: You can display multiple UOM on the front screen using only one input. E.g. View Ha & Ac at the same time.

OTHER SETTINGS

Use this to define implement width for Ha/Ac accumulation, External Run/Hold port if being used & number of alarm notifications

OUTPUT

Use this only to setup the Jackal to output a pulse (radar), Alarm, batch/trip & external hold.

The Jackal can be setup in many ways. You can choose 2UP & 3UP screens, 0-3 Decimal places for readouts, mix imperial & metric, label inputs, multiple pages of information, alarm points, trip functions & MORE

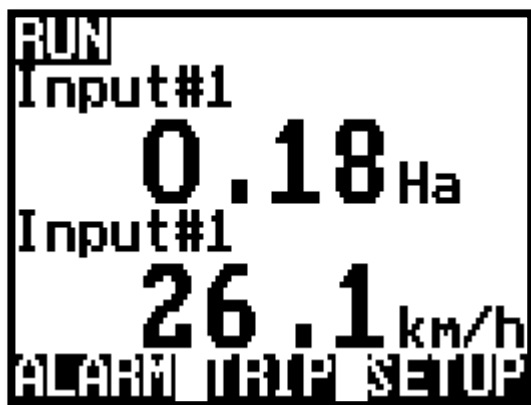

Example : 2 UP Speed & Area Meter
(Wheel Sensor)

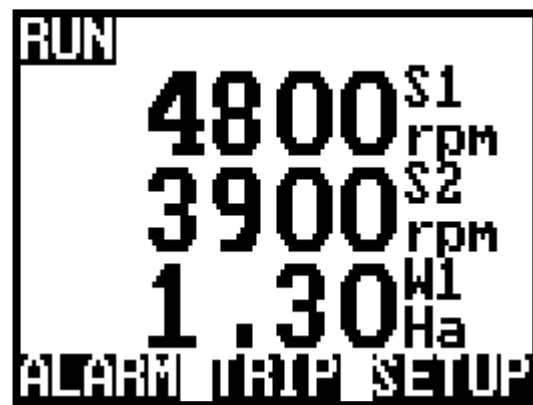

Example: 3 UP Monitoring 2x Shaft & Wheel
input for Ha

INPUTS

The Jackal has the following available selectable inputs

FRONT SCREEN > SETUP > INPUTS

Meter / Pulse (M)	Feet / Pulse (FT)	Yard / Pulse (YD)	Inch / Pulse (IN)
Kilometer / Pulse (KM)	Mile / Pulse (MI)	Pulse / Kilogram (KG)	Pulse / US Pound (LB)
Pulse / Litre (L)	Pulse / US Gallon (GAL)	Pulse / Bushel (BU)	Pulse / Rev (RPM)
Pulse / Bale (BALE)	Pulse / Unit (UNIT)	Pulse / Each (EACH)	

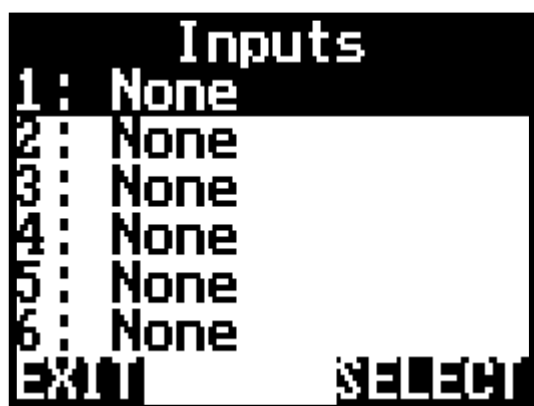

13 Inputs are available on the Jackal
Refer to Page 3 for input usage

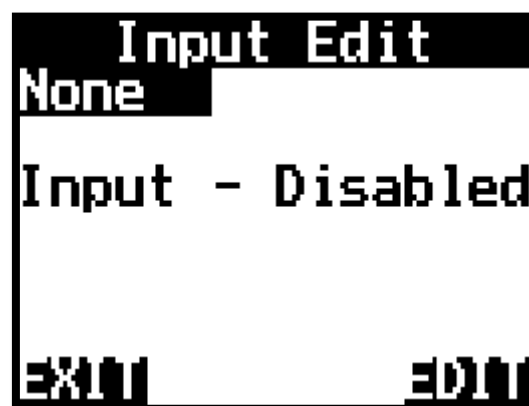

After selecting your input pressing the EDIT key allows
you to enable/disable the port

CALIBRATION METHOD – TARGET & MANUAL RATIO

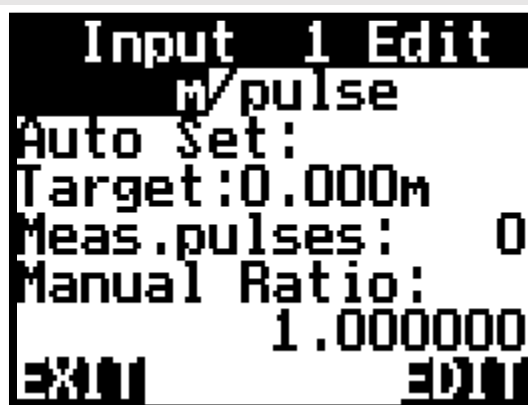

When the port has been enabled, using the UP/DOWN arrows navigates through the calibration setup.
Here you can also select your calibration method.

TARGET allows you to use the auto calibrate function and enter a known Unit Of Measure to calibrate pulses to. When the known UOM is entered the start button can be used to count the necessary pulses. Once the pulse have been counted press the CALC to auto update the MANUAL RATIO field

MANUAL RATIO allows you to enter a known calibration factor. This could be a pulse per litre factor for a flow meter to a known wheel circumference for speed & area (pulse/m). Scroll down & EDIT this field

FRONT SCREEN

FRONT SCREEN > SETUP > FRONT SCREEN

When your inputs have been selected and calibrated you can now choose to display them in any way on the front screen. You can have up to 3 line items per page and viewable at all times. If more lines are added you can **PAGE** or scroll through each screen

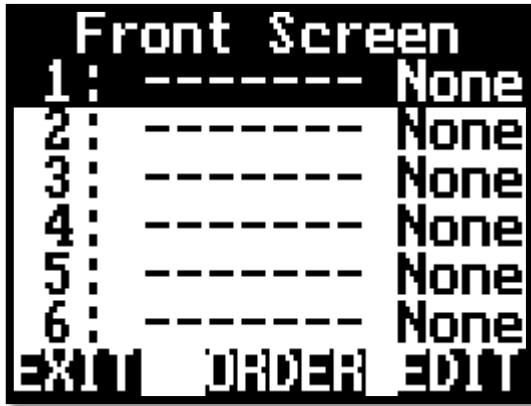

Select the line you wish to display your information and press EDIT



Enable the LINE by selecting EDIT

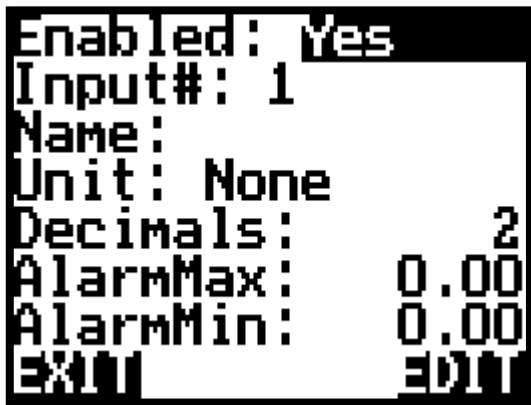

Here you can assign the Input to the Line. I.e. Input 1 to display km/hr on Line 1. It is also possible to set Min & Max alarm points for that input (Example Below)



By scrolling down to NAME and selecting EDIT you can name your port for easier identification on the front screen.

FRONT SCREEN > SETUP > FRONT SCREEN > ORDER

At any stage you can re order the lines on the front screen. For example – you may want to have Shaft 1 on the top line, shaft 2 on the 2nd line & Area on the 3rd line etc.

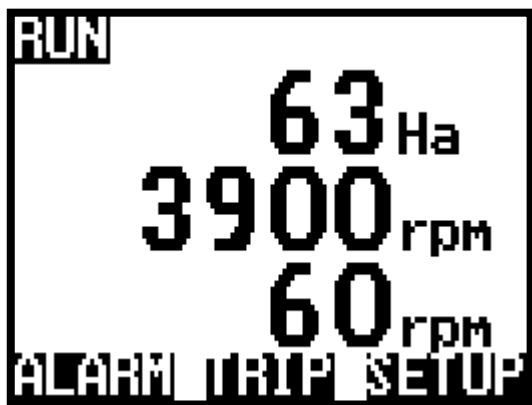

Example above displays :

Line 1 – HA, Line 2 – Shaft 1, Line 3 – Shaft 2

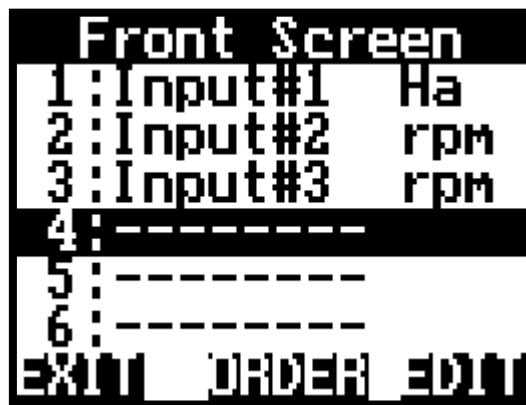

To re order. Navigate to SETUP > FRONT SCREEN

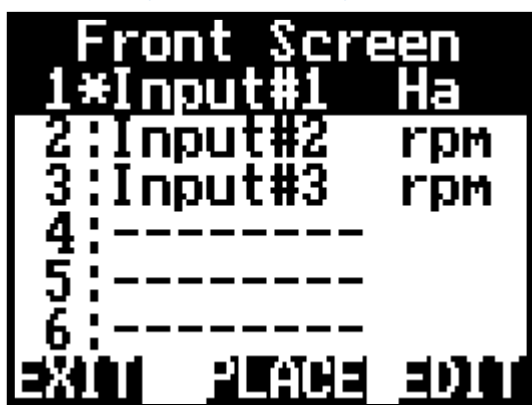

Highlight the line you wish to move & press ORDER. It will now place a * in front of the line. (like above)

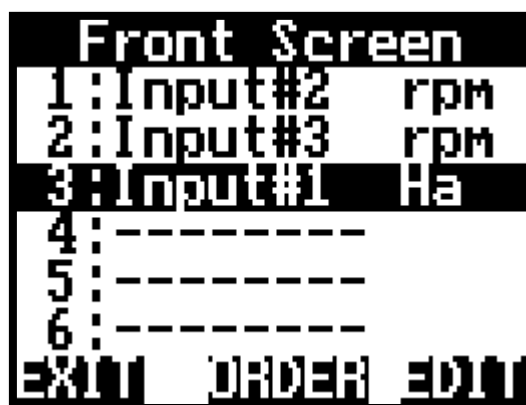

Using the up & down arrow, move the input to the desired line & select PLACE.

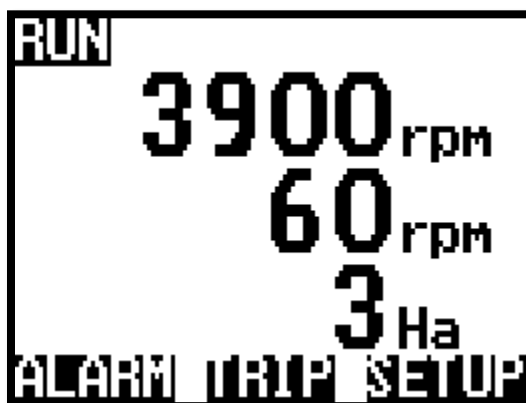

When you now EXIT back to the front screen the order of lines have been changed
Line 1 – Shaft1, Line 2 – Shaft 2, Line 3 – HA

OTHER SETTINGS

FRONT SCREEN > SETUP > OTHER SETTINGS

Use to setup Implement width for display Ha/Ac, Enable/Disable remote run/hold function & audible alarm notifications

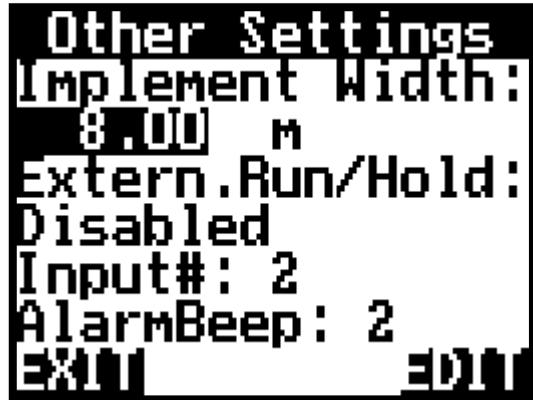

If you wish to display Ha/Ac on the front screen you need to have an implement width set. By default the Jackal displays 8m.

You can adjust the implement with and choose your UOM (M, FT, YD, IN, KM, MI).

If the UOM & implement widths remain untouched the Jackal will not display the information unless specified in the FRONT SCREEN setup.

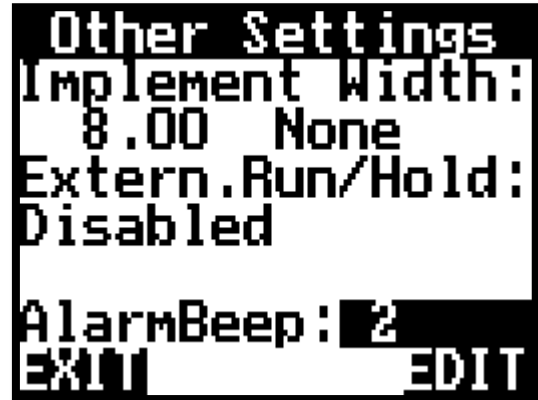

By changing the Alarm Beep you can define how many audible “Beeps” can be heard during the Alarm alert.

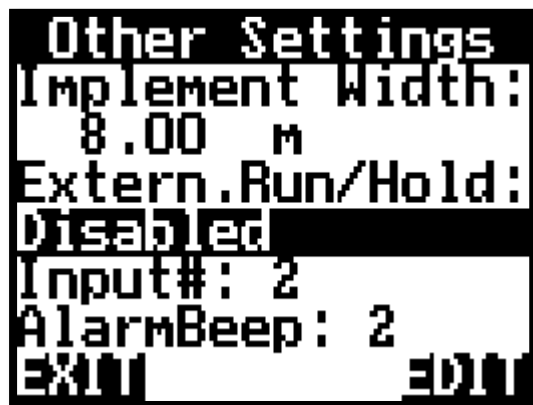

The EXTERNAL RUN/HOLD function can be used to disable all accumulating values and alarms set in the Jackal. It duplicates the operation of the RUN/HOLD button available on the front screen.

NOTE – When the EXTERNAL RUN / HOLD is active on ANY input the function of the RUN /HOLD button on the front screen is disabled.

Input of the switching function to active the EXTERNAL RUN/HOLD can be applied to any of the 13 available inputs on the Jackal. To enable maximum flexibility for this function NORMALLY ON or NORMALLY OFF mode can be selected for this function.

These are described below:

When a circuit exists between the selected input and ground (GND), selecting **NORMALLY ON** will result in the Jackal going into HOLD mode

Selecting **NORMALLY OFF** will result in the reverse i.e. the JACKAL will be in RUN mode until the circuit is broken after which it will go into HOLD mode.

After you select the desired hold method select the INPUT# port that is being used to detect Run/hold
Disabled : External Run/Hold is not used. Use the Run/Hold (2/3) button only.

FRONT SCREEN > SETUP > OUTPUT

Use the edit key to select the desired output option available on the desired port

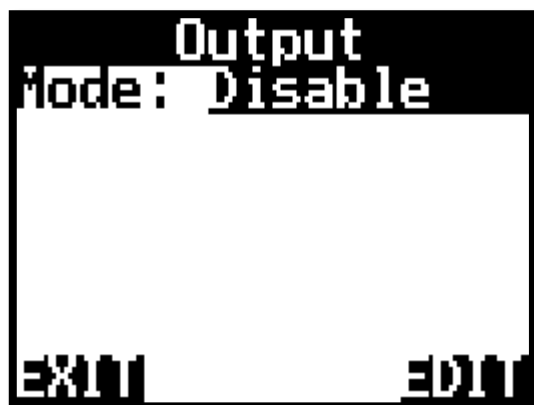

Select the EDIT button to Disable or choose an output function

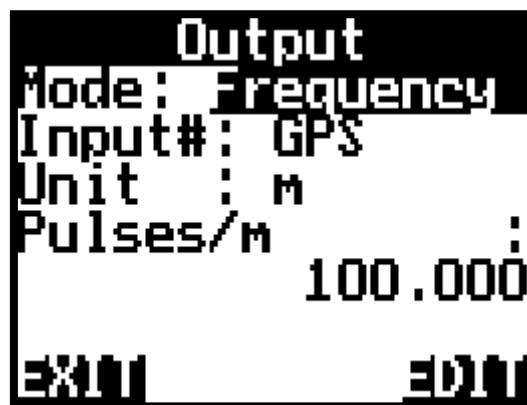

When FREQUENCY is selected the Jackal will output a pulse frequency that can be adjusted in ratio to a selected input

i.e. in the above example, if a GPS was inputting serial NMEA messages that contained speed information, the output could be configured to pulse at a rate of 100 pulses / meter, therefore simulating a Radar.

Please refer to CONNECTION details on Page 3 for connecting requirements

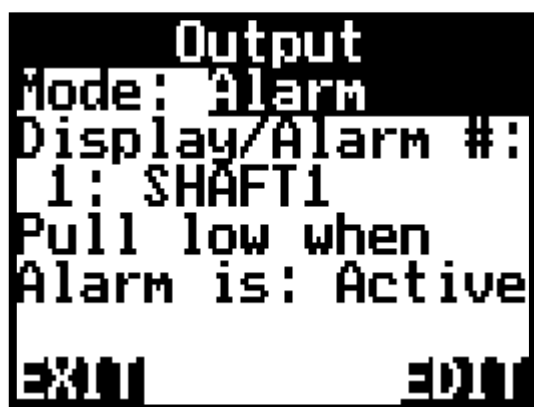

In the above example the Jackal can be selected to leave the output disconnected or pull low when an alarm on a selected input is active. This can be used to provide remote alarm functionality.

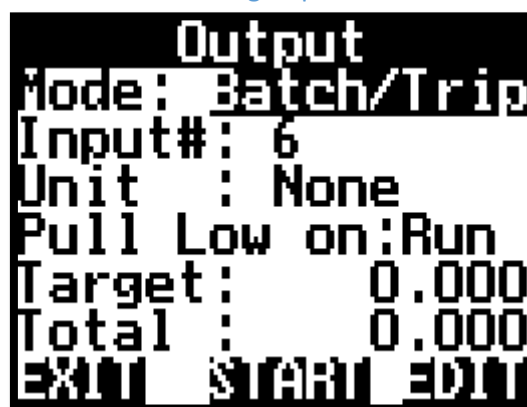

For Batching or Trip functionality the Jackal can be used to turn ON or turn OFF a valve / warning or any control function when a batch total or trip total has been reached. Select your INPUT and the UNITS to be measured.

FRONT SCREEN > SETUP > GPS/SERIAL

```

GPS
Date : 00 ---
Time : 00:00:00
Speed: 1.0km/h
Heading: 0°
Long : 0.00000
Lat : 0.00000
EXIT SETUP

```

When an external GPS is connected to Input A11 of the Jackal you can confirm & view valid messages are being received

```

GPS Setup
Baud Rate: 38400
NMEA Messages:
GGA: N      VTG: N
RMC: N      0
EXIT EDIT

```

In the SETUP screen you can change the Baud Rate & confirm GGA+VTG or RMC. When a valid string is being received the N will change to a Y

TRIPS (EXPLAINED)

DESCRIPTION

The Trip Page lists all display values that are accumulating. Examples include Area (Ha, Acres), Distance (m, km, miles), Weight (kg, lb, T), Volume (L). Instantaneous readings such as Speed, Flow Rate etc are not accumulating and won't show on the Trip Page

SETUP

FRONT SCREEN > TRIP



The screen above allows you to SAVE/RESET individual trips or view SAVED TRIPS

By pressing the SAVE/RESET you have the ability to Reset Trip | Save Trip | Reset All

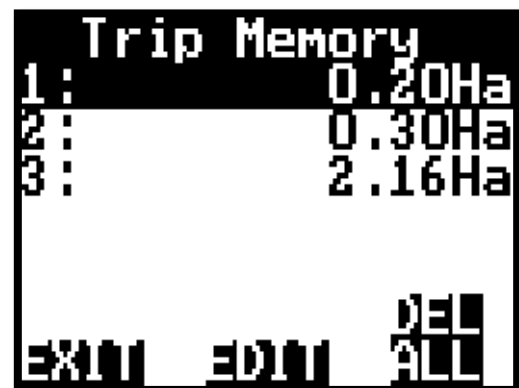

By selecting the 2. Save Trip it will be stored in the SAVED TRIPS option

You can now view the SAVED TRIPS. You also have the ability to EDIT & name the Trip or DEL ALL (Delete All Trips)



When you return to the TRIPS page the Trip will continue to accumulate. (Like above) – You will need to SAVE/RESET the trip if you want to start from Zero (0) again

ALARM

DESCRIPTION

Alarms are set on a per Display Value basis. High/Low Alarm points can be set for any value and will be displayed visually & made audible.

During the wizard or manual setup you have the option to set an Alarm MIN & Alarm MAX.



Wizard or manual alarm points.
Example of a Shaft Alarm set at
Min of 1000RPM & Max of 3000RPM

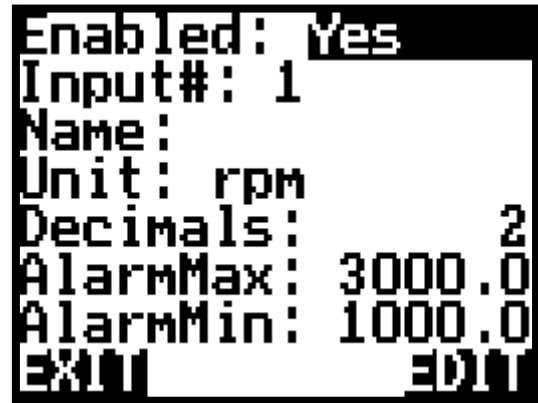

Manual/User setup Alarm points via the
FRONT SCREEN SETUP



When the alarm point is reached i.e. over 3000RPM the line will FLASH notifying you of the issue.

Press ALARM to enter the page showing all Alarms (active and inactive) to reset the alarm.

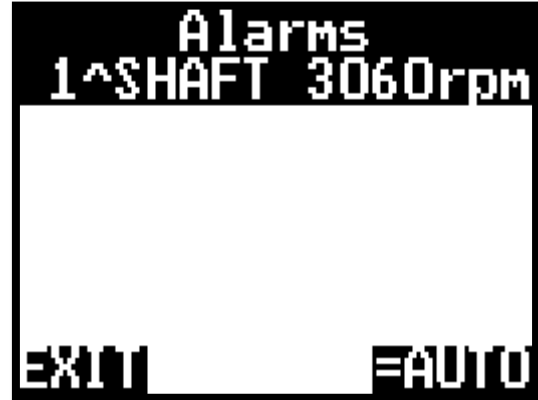

In the example above Line 1 is ^ over the alarm set point. If it was below it would show 1 v. You have 3 options

=AUTO : As soon as the value moves back within the Min & Max range the monitor will automatically reset the alarm.

=ON : When the alarm is activated it will remain ON until you enter the ALARM menu and manually reset

=OFF : You can disable the alarm altogether



Farmscan Ag Pty Ltd

ABN 92 143 803 070

11/493 South Street

Toowoomba QLD 4350

AUSTRALIA

Ph +61 (7) 4602 4150

Fax +61 (7) 4602 4151

sales@farmscanag.com

©2013 Farmscan AG Pty Ltd

AM-JACKAL-2 July 2013

V1207