

LAW ENFORCEMENT
CORRECTIONS
FIRE & EMS
POSTAL
TRANSPORTATION



Serving Those Who Protect Since 1907

2020 PRODUCT CATALOG

CONTENTS

3 POLOS

- Ufx Tactical
- Ufx Comfort Polo
- Ufx Uniform Polo
- Ufx Ultra-light Polo

7 EXTERNAL VEST CARRIER & ACCESSORIES

- BodyShield
- VSS1 Suspension System
- Pouches

9 DAILY DUTY UNIFORMS

- UV1 Undervest Shirt
- UV2 FlexTech
- Reflex
- Distinction
- TexTrop2
- DutyMaxx
- Tek3
- ADU

23 DRESS UNIFORMS

- Wool Blend Blousecoats and Pants
- Top Authority Blousecoats and Pants
- Paragon Plus Shirt
- Express Dress Shirt
- First Responder Shirt

27 WEST COAST UNIFORMS

- 65/35 Poly/Cotton Twill
- 65/35 Poly/Rayon
- 100% Wool
- 55/45 Poly/Wool
- Prestige Hidden Cargo Pocket Pants

31 BASE LAYERS, MID LAYERS, OUTERWEAR

- Base Layers
- FlexTech Jacket
- Job Shirt
- Duty Jacket
- Duty Parka
- Pinnacle Jacket
- Performance Soft Shell
- Genesis Jacket

38 HiVis

- Reversible Soft Shell
- Color Block Soft Shell
- HiVis Parka
- HiVis Safety Vest

41 APPENDIX

- BodyShield Fit Guide
- Product Code Index

FABRIC TECHNOLOGY

Nano Moisture Wicking

Permanent fiber technology pulls fluids away from the skin and evaporates off the fabric for quick dry comfort.

Nano Fluid Repellency

Permanent fiber technology repels fluids, which bead up and roll off the fabric to keep you dry and comfortable.

UV Protection

UV40+ protection against the sun while protecting the fabric from fading.

Hydrotech

Waterproof, windproof and breathable membrane to keep you warm, dry and comfortable.

Anti-Microbial

Reduces the bacteria that causes odor over time.

3-in-1 System

Outerwear system with light, mid, and heavy options for versatility to stay warm, dry and comfortable in fluctuating conditions.

Stock size availability charts are available at elbeco.com.





Ufx TACTICAL POLOS

You don't need to sacrifice comfort for a professional appearance. Designed for superior functionality, fit and performance, the Ufx™ Tactical Polos offer the best of both worlds. Engineered for action, it features stretch fabric for improved range of motion and moisture-wicking and antimicrobial technologies that will keep you dry and comfortable for the life of the shirt.

- Dual hidden mic shoulder pockets and mic/eyeglass loop at bottom of placket on chest
- No-curl knit collar with stays for professional appearance
- Dual pen pocket on left sleeve for easy access
- UV protection reduces sun damage
- 100% Polyester Swiss Pique Knit | 7.25 oz./sq. yard machine washable



Midnight Navy:
 Tactical Men's LS: K5144
 Tactical Men's SS: K5134
 Tactical Women's LS: K5184LC
 Tactical Women's SS: K5174LC

Black:
 Tactical Men's LS: K5141
 Tactical Men's SS: K5131
 Tactical Women's LS: K5181LC
 Tactical Women's SS: K5171LC

Tan:
 Tactical Men's LS: K5142
 Tactical Men's SS: K5132
 Tactical Women's LS: K5182LC
 Tactical Women's SS: K5172LC

Spruce Green:
 Tactical Men's SS: K5137
 Tactical Women's SS: K5177LC

O.D. Green:
 Tactical Men's LS: K5146
 Tactical Men's SS: K5136

Gray:
 Tactical Men's LS: K5148
 Tactical Men's SS: K5138
 Tactical Women's LS: K5188LC
 Tactical Women's SS: K5178LC

White:
 Tactical Men's LS: K5140
 Tactical Men's SS: K5130
 Tactical Women's LS: K5180LC
 Tactical Women's SS: K5170LC

French Blue:
 Tactical Men's LS: K5149
 Tactical Men's SS: K5139
 Tactical Women's LS: K5189LC
 Tactical Women's SS: K5179LC

Royal Blue:
 Tactical Men's LS: K5151
 Tactical Men's SS: K5152
 Tactical Women's SS: K5162LC





Light Blue:
 Tactical Men's LS: K5143
 Tactical Men's SS: K5133

Red:
 Tactical Men's LS: K5145
 Tactical Men's SS: K5135

Ufx UNIFORM POLOS

Simply the best uniform polo available. The Ufx™ Uniform Polo allows first responders to enjoy all-day comfort while maintaining a professional appearance. Designed for every aspect of today's job, it features stitched-in creases and stretch fabric with permanent Nano Moisture Wicking and antimicrobial technologies. A wealth of functional features enhances utility, lending this shirt a perfect combination of performance, professionalism, comfort and quality.

- Two-piece dress collar with stays for a traditional look
- Innovative non-stretch badge tabs supports weight of metal badge
- Chest pockets with functional scalloped flaps and hook and loop closure
- UV protection reduces sun damage
- 100% Polyester Swiss Pique Knit | 7.25 oz./sq. yard machine washable



			
Midnight Navy:	Tan:	White:	Light Blue:
Men's LS: K5124 Men's SS: K5104	Men's SS: K5102	Men's SS: K5100	Men's SS: K5103





Ufx ULTRA-LIGHT POLOS

Designed for visibility, the Ufx™ Ultra-Light Polos deliver in any situation with HiVis and reflective color block options. Engineered for action, the lightweight 4-way stretch fabric and flex underarm mesh vents provide superior range of motion and ventilation and boast permanent Nano Moisture Wicking and antimicrobial technologies.

- 30% lighter than standard Ufx fabric
- 3M™ heat sealed patterned reflective striping provides nighttime visibility
- UV protection reduces sun damage
- HiVis yellow shirt is ANSI 207-2010 Class 2 Level 2 Certified
- 100% Polyester Swiss Pique Knit | 5.0 oz./sq. yard machine washable

	
Midnight Navy:	ANSI 2 HiVis:
Men's SS: K5234 Women's SS: K5274LC	LS: K5226 SS: K5216



	
Royal Blue / Navy:	HiVis / Navy:
LS: K5223 SS: K5213	LS: K5224 SS: K5214



Zippered Chest Pocket



Permanent Collar Stays



Sunglasses / Mic Loop



Flex Underarm Mesh

—NEW—

Ufx COMFORT POLOS

Our newest polo option provides the comfort and breathability of cotton, the performance and color retention of synthetic, and the comfort stretch of Spandex, enhanced with moisture-wicking and antimicrobial technologies and UV protection.

- Dual hidden mic shoulder pockets and mic/eyeglass loop at bottom of placket on chest
- Lined self collar prevents curling for a professional appearance
- Dual pen pocket on left sleeve for easy access
- Flex underarm mesh vents provide ventilation and increased range of motion
- UV protection reduces sun damage
- 57% Cotton/38% Polyester/5% Spandex Pique Knit Blend | Weight: 5.5 oz./sq. yard



Midnight Navy:

Men's LS: K6414

Men's SS: K6404



Black:

Men's LS: K6411

Men's SS: K6401



Heather Gray:

Men's LS: K6418

Men's SS: K6408





BODYSHIELD EXTERNAL VEST CARRIER

The BodyShield™ External Vest Carrier allows you to wear a ballistic vest over your uniform for maximum comfort and accessibility while remaining virtually invisible to the untrained eye.

- UV protection reduces damage from the sun
- Antimicrobial technology in the lining and neck opening prevents the buildup of odor-causing bacteria
- FastLock side closure system allows for easy on and off
- Multiple pockets and available pouches allow for customizable storage options
- Shell Fabric: 600 Denier Syntex 100% Polyester Plain Weave | Weight: 7.2 oz./sq. yard
- Lining Fabric: 65% Polyester/35% Cotton Twill Weave | Weight: 5.5 oz./sq. yard



Fit guide on page 41

				
Midnight Navy: V3114B V3124WCB (West Coast)	Black: V3110B	Tan: V3112B	Brown: V3115B	Spruce Green: V3117B



Zippered
Cummerbund



Functional Epaulets



Large, Hidden
Document Pocket



Pen Pocket



Zipper Opening
on Placket

VSS1 SUSPENSION SYSTEM

Eliminate the need for belt keepers and lighten your load. The VSS1 Suspension System redirects the weight of your duty belt from your hips and lower back, providing a feeling of weightlessness.

- Adjustable shoulder pads provide all-day comfort
- Optional crosspiece available for added stability
- Recommended for use with the Elbeco BodyShield™ External Vest Carrier
- Strap Fabric: Polyester Latex Webbing with 15% Stretch and 100% Recovery with hardened web tips to prevent unraveling
- Clips: Chemlon nylon in a flat black finish



Black:
VSS1

BODYSHIELD POUCHES AND ACCESSORIES

The BodyShield™ External Vest Carrier line of pouches allows you to move your equipment off of your duty belt and onto the vest carrier. This redistributes weight to make you more comfortable and reduce stress on your body.

- Color matched to blend with the BodyShield™ Vest Carriers
- Pouches must be sewn on to the vest carrier
- UV protection reduces damage from the sun
- 600 Denier Syntex 100% Polyester Tropical Weave | Weight: 7.2 oz./sq. yard



Midnight Navy:

- Stun Gun: P4STNGUN
- Single Mag: P4MAGSNG
- Double Mag: P4MAGDBL
- West Coast Double Mag: P4MAGDBN
- OC Mace: P4MACE
- Small Light: P4FLSHSM
- Handcuffs: P4HANDCF
- Radio: P4RADIO Flashlight/Baton: P4FLSHLG Utility Pouch: P4UTIL Molle Strap: G0074NV1



Black:

- Stun Gun: P0STNGUN
- Single Mag: P0MAGSNG
- Double Mag: P0MAGDBL
- OC Mace: P0MACE
- Small Light: P0FLSHSM
- Handcuffs: P0HANDCF
- Radio: P0RADIO Flashlight/Baton: P0FLSHLG Molle Strap: G0074BK1 Quick Clips: QKCLPBLK



Tan:

- Stun Gun: P2STNGUN
- Single Mag: P2MAGSNG
- Double Mag: P2MAGDBL
- OC Mace: P2MACE
- Small Light: P2FLSHSM
- Handcuffs: P2HANDCF
- Radio: P2RADIO
- Flashlight/Baton: P2FLSHLG Molle Strap: G0074TN1
- Quick Clips: QKCLPTAN



Quick Clips



OC / Mace



Flashlight Baton



Handcuffs



Single Mag



Double Mag



Radio



Utility Pouch



Stun Gun



Small Light
elbeco.com



UV1 UNDERVEST SHIRT

A flexible, functional and comfortable alternative to a traditional uniform shirt, the UV1™ Undervest Shirt offers both professional appearance and casual style. Visible portions of shirt match Class A shirt and coordinating V-Series External Vest Carrier, making it a must-have as part of a daily duty uniform.



- Permanent Nano Wicking technology pulls moisture away from the body for quick-dry comfort
- Antimicrobial technology prevents the buildup of odor-causing bacteria
- Enhanced flex underarm mesh vents increase ventilation and range of motion
- Dual communication wire access openings in side seams conceal and contain wires
- Polyester Style Visible Shirt Fabric: 100% Textured Stretch Polyester Tropical Weave | Weight: 5.5 oz./sq. yard
- Poly/Wool Style Visible Shirt Fabric: 75% Polyester/25% Worsted Wool/ Premium Tropical Weave | Weight: 5.5 oz./sq. yard
- Knit Torso Fabric: 100% Featherweight Performance Polyester | Weight: 4.25 oz./sq. yard



Dual Comm Wire Access Openings



Functional Epaulets



Flex Underarm Mesh

Midnight Navy:
 Men's LS: UVS101
 Men's LS: UVS151*
 Men's SS: UVS102
 Men's SS: UVS152*
 Women's LS: UVS103
 Women's SS: UVS104
 *Poly/Wool Styles

Black:
 Men's LS: UVS117
 Men's SS: UVS118

Tan:
 Men's LS: UVS113
 Men's SS: UVS114

Brown:
 Men's LS: UVS121
 Men's SS: UVS122

Spruce Green:
 Men's LS: UVS105
 Men's SS: UVS106
 Women's LS: UVS107
 Women's SS: UVS108



—NEW—

UV2 FLEXTech UNDERVEST SHIRT

Worn under a vest carrier, the UV2 provides a clean and professional appearance. Expanding our successful UV1 series, the UV2 FlexTech offers warmth in colder temperature conditions without bulk when worn under vest carriers. The UV2 FlexTech provides exceptional comfort, mobility, and shade retention from both the top FlexTech fabric and the bottom Ufx polo fabric.

- Flex-vent underarm mesh for breathability and increased range of motion
- Cleanly fits under vest carriers while ensuring access to equipment
- 3-snap closure placket for easy on and off
- Upper portion features Nano Fluid Repellency
- Lower portion features moisture wicking and antimicrobial technologies
- Upper Shell Fabric: Unlined 100% Polyester FlexTech | Weight: 8.0 oz./sq. yard
- Lower Shell Fabric: 100% Polyester Ufx Tactical Polo Pique Knit | Weight: 7.25 oz./sq. yard

Midnight Navy:
Men's LS: UVS204

UV2

10

REFLEX

Made for modern duty, Reflex™ Uniforms combine Class A professionalism with Class B functionality for a daily duty uniform that impresses in any setting. The high-quality polyester blend stretch RipStop fabric allows for natural body movement. With innovative features such as permanent Nano Fluid Repellency and UV protection, this is a uniform designed with the job in mind.

Shirts

- Enhanced flex underarm mesh vents increase ventilation and range of motion
- Dual communication wire access openings in side seams conceal and contain wires
- Dual-access chest pockets have top and side utility compartments for added storage
- Permanent Nano Fluid Repellency allows fluids to bead and roll off fabric
- UV protection reduces damage from the sun
- 65% Polyester / 35% Cotton RipStop with 18% Permanent Fiber Stretch | Weight: 5.8 oz./sq. yard

NEW

Caps

- Higher front profiles for easier embroidery access
- Seven panel construction with vent holes for durability and comfort



Midnight Navy:

Men's LS: 4424
Men's SS: 4444
Women's LS: 4434LC
Women's SS: 4454LC
Cap: CAP34



Black:

Men's LS: 4420
Men's SS: 4440
Women's LS: 4430LC
Women's SS: 4450LC
Cap: CAP30



Chest Pockets with Side Compartments



Flex Underarm Vents



REFLEX

Pants and NEW Shorts

- Permanent Nano Fluid Repellency allows fluids to bead and roll off fabric
- Hidden cargo styles have internal compartments and zippered closures
- External cargo styles have notched front pockets with knife clip reinforcements, utility pockets and magnet closures on flaps
- Shorts are external cargo with magnet closure on flaps, utility pockets and notched front pockets
- Covert flex waistband provides 2" stretch while holding up duty belt
- Diamond-shaped crotch gusset provides comfort and mobility
- UPF 50 protection reduces damage from the sun
- 65% Polyester/35% Cotton RipStop with 12% Fiber Stretch | Weight: 6.5 oz./sq. yard

REFLEX

Midnight Navy:

Men's Hidden Cargo: E7344R

Men's Cargo: E7364R

Men's Shorts: E7384

Women's Hidden Cargo: E7354LC

Women's Cargo: E7374LC

Women's Shorts: E7394LC

Black:

Men's Hidden Cargo: E7340R

Men's Cargo: E7360R

Men's Shorts: E7380

Women's Hidden Cargo: E7350LC

Women's Cargo: E7370LC

Women's Shorts: E7390LC

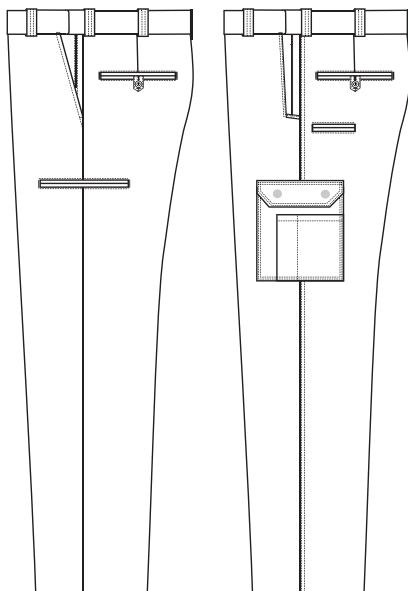

Hidden Cargo

Cargo



Cargo Pockets with Magnets



Nano Fluid Repellency

DISTINCTION

Combining enhanced functionality and added storage with professionalism, the Distinction™ Uniforms are the next generation of Poly/Wool uniforms. Designed for the demands of today's job, it delivers exceptional comfort, quality and performance.

Shirts

- Enhanced flex underarm mesh vents increase ventilation and range of motion
- Dual communication wire access openings in side seams conceal and contain wires
- Dual-access chest pockets have top and side utility compartments for added storage
- Hidden zip front offers easy closure while providing a tapered look and feel
- 75% Textured Polyester/25% Worsted Wool/Premium Tropical Weave | Weight: 5.5 oz./sq. yard



Midnight Navy:

Men's LS: 840N
 Men's SS: 8840N
 Women's LS: 9340LCN
 Women's SS: 9840LCN
 Men's Plain Pocket LS: 850N*
 Men's Plain Pocket SS: 8850N*
 Women's Plain Pocket LS: 9350LCN*
 Women's Plain Pocket SS: 9850LCN*

*West Coast Styles



Black:

Men's LS: 841N
 Men's SS: 8841N
 Women's LS: 9341LCN
 Women's SS: 9841LCN



Concealed
Front Zipper



Dual Chest Utility
Pockets



Chest Pockets
with Velcro



Dual Comm
Wire Access



Functional Epaulets



Flex Underarm Mesh



DISTINCTION

Pants

- Covert flex waistband provides 2" stretch while holding up duty belt
- Multiple options available including 4-pocket, straight front, 10-pocket, cargo, and hidden cargo
- Triple-stitched crotch prevents seam failure
- 74% Polyester/25% Wool/1% Lycra Premium Serge Weave | Weight: 7.6 oz./sq. yard

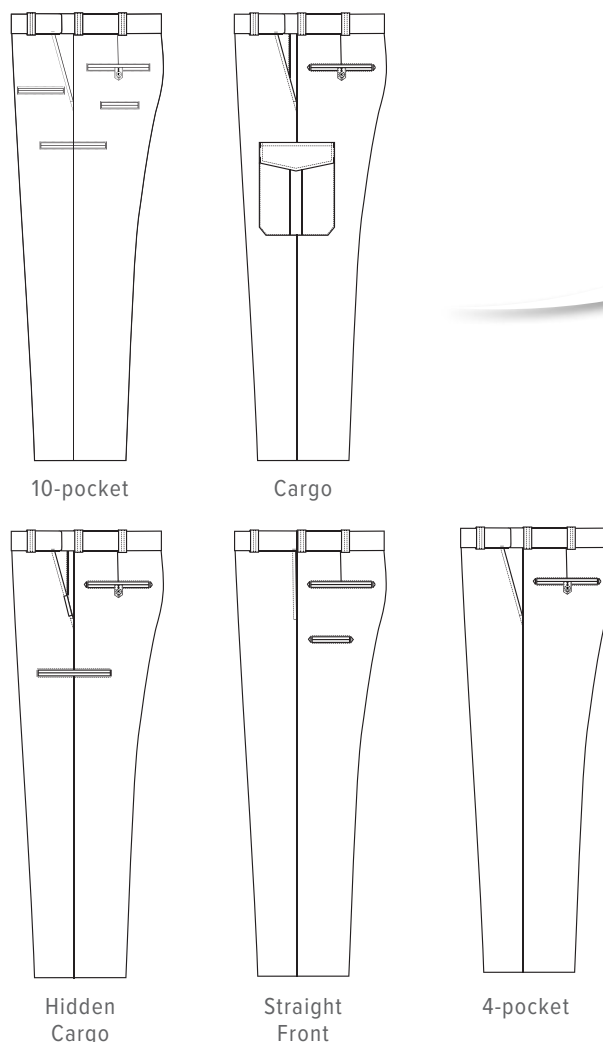

Midnight Navy:

- Men's 4-Pocket: E494RN
- Men's Straight Front Pocket: E454R
- Men's Hidden Cargo: E444R
- Men's Cargo: E4030RN
- Men's 10-Pocket: E4024R
- Women's 4-Pocket: E9494LCN
- Women's Straight Front Pocket: E9454LC
- Women's Hidden Cargo: E9444LC
- Women's Cargo: E4031LCN
- Women's 10-Pocket: E4025LC



Black:

- Men's 4-Pocket: E490R
- Men's Hidden Cargo: E440R
- Men's Cargo: E4040R
- Women's 4-Pocket: E9490LC
- Women's Hidden Cargo: E9440LC
- Women's Cargo: E4041LC



Covert Waistband



Double Hook and Eye Closure

TEXTROP2

Professional appearance meets pro performance. The Textrop2™ Polyester Uniforms combine crisp detailing with superior comfort and utility for a sharp uniform that offers an edge when in action. From stitched-in creases and functional details and advanced moisture-wicking technology, this uniform delivers no matter the situation. Made with the job in mind, Textrop2™ won't fade, shrink or wrinkle.

Shirts

- Permanent Nano Wicking technology pulls moisture away from the body for quick-dry comfort
- Enhanced flex underarm mesh vents increase ventilation and range of motion
- Dual communication wire access openings in side seams conceal and contain wires
- Dual-access chest pockets have top and side utility compartments for added storage
- Zippered styles have false button-front plackets with concealed zipper closures
- 100% Polyester Tropical Weave | Weight: 5-5.5 oz./ sq. yard



Midnight Navy:

- Men's LS: 314N
- Men's SS: 3314N
- Women's LS: 9314LCN
- Women's SS: 9814LCN
- Men's Zippered LS: Z314N
- Men's Zippered SS: Z3314N
- Women's Zippered SS: Z9814LCN
- Men's 4-Pocket: E314RN
- Men's Hidden Cargo: E394R
- Men's Cargo: E8875RN
- Women's 4-Pocket: E9314LC
- Women's Hidden Cargo: E9394LC
- Women's Cargo: E8876LC



Black:

- Men's LS: 320N
- Men's SS: 3320N
- Women's LS: 9320LCN
- Women's SS: 9820LCN
- Men's 4-Pocket: E320RN
- Men's Hidden Cargo: E390R
- Women's 4-Pocket: E9320LC
- Women's Hidden Cargo: E9390LC



Tan:

- Men's LS: 312N
- Men's SS: 3312N
- Women's LS: 9312LCN
- Women's SS: 9812LCN
- Men's Zippered LS: Z312N
- Men's Zippered SS: Z3312N



Brown:

- Men's Zippered LS: Z315N
- Men's Zippered SS: Z3315N
- Women's Zippered LS: Z9315LCN
- Women's Zippered SS: Z9815LCN
- Men's 4-Pocket: E315RN
- Women's 4-Pocket: E9315LC



White:

- Men's LS: 310N
- Men's SS: 3310N
- Women's LS: 9310LCN
- Women's SS: 9810LCN
- Men's Zippered LS: Z310N
- Men's Zippered SS: Z3310N
- Women's Zippered SS: Z9810LCN



Chest Pockets with Velcro



Dual Comm Access Wire



Functional Epaulets



Flex Underarm Mesh

Spruce Green:

- Men's Zippered LS: 8803N
- Men's Zippered SS: 8805N
- Women's Zippered LS: 8802LC
- Women's Zippered SS: 8804LC
- Men's 4-Pocket: E8911RN
- Men's 4-Pkt/Black Stripe: E8903RN
- Men's 4-Pkt/Gray Stripe: E8905RN
- Men's Hidden Cargo: E8909PB
- Men's Hidden Cargo Black Stripe: E8960R
- Women's 4-Pocket: E8912LC
- Women's 4-Pkt/Black Stripe: E8904LC
- Women's 4-Pkt/Gray Stripe: E8906LC
- Women's Hidden Cargo: E8910LCP
- Women's Hidden Cargo Black Stripe: E8961LC

Gray:

- Men's LS: 311N
- Men's SS: 3311N
- Women's LS: 9311LCN
- Women's SS: 9811LCN
- Men's Zippered SS: Z3311N

French Blue:

- Men's LS: 319N
- Men's SS: 3319N
- Women's LS: 9319LCN
- Women's SS: 9819LCN

Blue:

- Men's LS: 313N
- Men's SS: 3313N
- Women's LS: 9313LCN
- Women's SS: 9813LCN



TEXTROP2

Pants

- Permanent Nano Wicking technology pulls moisture away from the body for quick-dry comfort
- Covert flex waistband provides 2" stretch while holding up duty belt
- Multiple options available including 4-pocket, cargo, and hidden cargo
- New men's "Essential Fit" pattern waistband features lower rise and wider leg, with front rise having a slight slope
- 100% Polyester Stretch Textured Serge Weave | Weight: 7.0 oz./ sq. yard

TEXTROP2

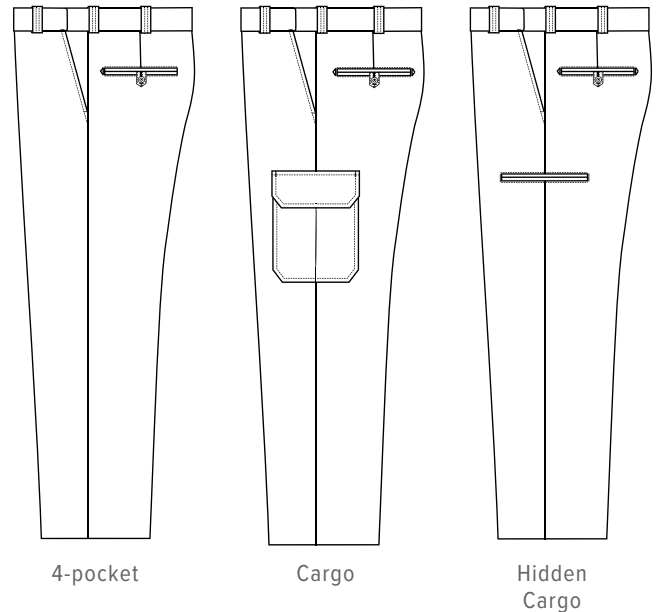

4-pocket

Cargo

Hidden Cargo



Covert Waistband



Double Hook and Eye Closure

DUTYMAXX

An everyday duty uniform that's designed for the demands of today's job, the DutyMaxx™ Stretch Uniforms boast enhanced technology for optimal functionality, fit and performance. Get the protection and durability you need on the job with innovative features and professional appearance.

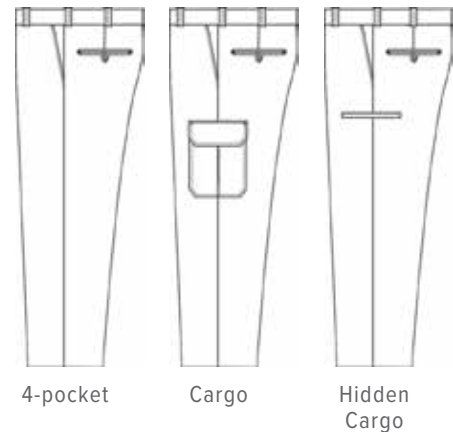

Shirts

- Enhanced flex underarm mesh vents increase ventilation and range of motion
- Dual communication wire access openings in side seams conceal and contain wires
- Permanent Nano Fluid Repellency allows fluids to bead and roll off fabric
- Tapered fit
- 80% Polyester/20% Rayon Tropical Weave 14% Fiber Stretch | Weight: 6 oz./sq. yard

Pants

- Permanent Nano Fluid Repellency allows fluids to bead and roll off fabric
- Triple-stitched crotch prevents seam failure
- Creaset front and back permanent creases maintain a professional appearance in any situation
- Multiple options available including 4-pocket, cargo, and hidden cargo
- 80% Polyester/20% Rayon Serge Weave with 14% Fiber Stretch | Weight: 7.5 oz./sq. yard



Midnight Navy:

- Men's LS: 584D
- Men's SS: 5584D
- Women's LS: 9584LCD
- Women's SS: 9784LCD
- Men's 4-Pocket: E254RND
- Men's Hidden Cargo: E224RND
- Men's Cargo: E234RND
- Women's 4-Pocket: E9254LCD
- Women's Hidden Cargo: E9224LCD
- Women's Cargo: E9234LCD



Brown:

- Men's 4-Pocket: E255RN
- Men's Hidden Cargo: E245RN
- Women's 4-Pocket: E9255LC
- Women's Hidden Cargo: E9245LC



Tan:

- Men's LS: 582D
- Men's SS: 5582D
- Women's LS: 9582LCD
- Women's SS: 9782LCD
- West Coast Men's LS: 592D
- West Coast Men's SS: 5592D
- West Coast Women's LS: 9592LCD
- West Coast Women's SS: 9792LCD



Gray:

- Men's LS: 581D
- Men's SS: 5581D
- Women's LS: 9581LCD
- Women's SS: 9781LCD



White:

- Men's LS: 580D
- Men's SS: 5580D
- Women's LS: 9580LCD
- Women's SS: 9780LCD



French Blue:

- Men's LS: 589D
- Men's SS: 5589D
- Women's LS: 9589LCD
- Women's SS: 9789LCD



Medium Blue:

- Men's LS: 586D
- Men's SS: 5586D
- Women's LS: 9586LCD
- Women's SS: 9786LCD



TEK3

You don't have to sacrifice performance for function and comfort. Our Tek3™ Uniforms offer a poly/cotton blend with permanent Nano Fluid Repellency technology to keep you dry and comfortable while maintaining the natural breathability of fabric through repeated washings. Boasting enhanced performance, functionality and fit, Tek3™ allows you to perform your best while keeping you comfortable.



Shirts

- Enhanced flex underarm mesh vents increase ventilation and range of motion
- Dual communication wire access openings in side seams conceal and contain wires
- Permanent Nano Fluid Repellency allows fluids to bead and roll off fabric
- Dual-access chest pockets have top and side utility compartments for added storage
- 65% Polyester/35% Cotton Stretch Twill Weave | Weight: 7.0-7.25 oz./sq. yard



Midnight Navy:

- Men's LS: G924
- Men's SS: G934
- Women's LS: G944LC
- Women's SS: G954LC
- Cap: CAP24



Black:

- Men's LS: G920NP
- Men's SS: G9220NP
- Cap: CAP10



Brown:

- Men's LS: G975NP
- Men's SS: G965NP



French Blue:

- Men's LS: G978NP
- Men's SS: G968NP
- Women's LS: G998LCP
- Women's SS: G988LCP



Flex Underarm Mesh



Nano Fluid Repellency



Dual Comm Wire Access



Chest Pockets with Velcro



Chest Pockets with Side Compartments



TEK3

Pants

- Permanent Nano Fluid Repellency allows fluids to bead and roll off fabric
- Covert flex waistband provides 2" stretch while holding up duty belt
- Triple-stitched crotch prevents seam failure
- Multiple options available including 4-pocket, cargo, and EMT
- 65% Polyester/35% Cotton Stretch Twill Weave | Weight: 7.0–7.5 oz./sq. yard

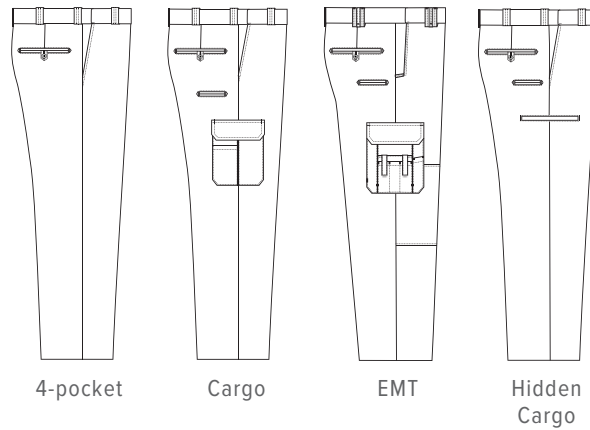

4-pocket

Cargo

EMT

Hidden Cargo

Midnight Navy:

- Men's 4-Pocket: E2804R
- Men's Cargo: E2844R
- Men's EMT: E2874R
- Men's Cargo Shorts: E2824
- Women's 4-Pocket: E2814LCD
- Women's Cargo: E2854LC
- Women's EMT: E2884LC
- Women's Cargo Shorts: E2834LC

Black:

- Men's 4-Pocket: E820RN
- Men's Cargo: E620RN
- Men's EMT: E7552RN
- Women's 4-Pocket: E9820LC
- Women's Cargo: E9620LCN
- Women's EMT: E7553LCN

Brown:

- Men's Hidden Cargo: E815RNH
- Men's Cargo: E615RN
- Women's Hidden Cargo: E9815LCH
- Women's Cargo: E9615LCN

O.D Green:

- Men's Cargo: E619RN
- Women's Cargo: E9619LCN

NJ

Midnight Navy:

- Men's Cargo/French Blue Stripe: E9025R
- Men's Cargo/Gold Stripe: E9027R
- Women's Cargo/French Blue Stripe: E9026LC



EMT Reflective Pocket



Double Hook and Eye Closure



Zipper Cargo Pocket





ADU

Get the professional look of a traditional Class B uniform without sacrificing comfort. Our enhanced ADU™ RipStop Uniforms are ideal for first responders who want durable lightweight clothing with the functionality and storage of a tactical uniform.

Shirts

- Permanent Nano Fluid Repellency allows fluids to bead and roll off fabric
- Dual communications wire access openings in side seams keep wires hidden
- Fused convertible collar with internal collar stays to prevent roll-up
- 65% Polyester/35% Cotton RipStop I Weight: 4.5 oz./sq. yard

Pants

- Cargo style offers low-profile pockets with back bellows and easy-access internal compartments for the storage of equipment and mag cartridges
- EMT style offers extra-large EMT-style storage pockets featuring 3M brand reflective trim under flaps
- Permanent Nano Fluid Repellency allows fluids to bead and roll off fabric
- Covert flex waistband provides 2" stretch while holding up duty belt
- Articulated knee improves mobility
- 65% polyester/35% Cotton RipStop I Weight: 6.75 oz./sq. yard



Midnight Navy:

- Men's LS: 5614
- Men's SS: 5634
- Women's LS: 5624LC
- Women's SS: 5644LC
- Men's Cargo: E5704R
- Men's EMT: E5724R
- Women's Cargo: E5714LC
- Women's EMT: E5734LC



Black:

- Men's LS: 5610
- Men's SS: 5630
- Women's LS: 5620LC
- Women's SS: 5640LC
- Men's Cargo: E5700R
- Women's Cargo: E5710LC



Khaki:

- Men's LS: 5612
- Men's SS: 5632
- Women's LS: 5622LC
- Women's SS: 5642LC
- Men's Cargo: E5702R
- Women's Cargo: E5712LC



Brown:

- Men's LS: 5615
- Men's SS: 5635
- Men's Cargo: E5705R
- Women's Cargo: E5715LC



Spruce Green:

- Men's LS: 5617
- Men's SS: 5637
- Women's LS: 5627LC
- Women's SS: 5647LC
- Men's Cargo: E5707R
- Women's Cargo: E5717LC



O.D. Green:

- Men's LS: 5619
- Men's SS: 5639
- Women's LS: 5629LC
- Women's SS: 5649LC
- Men's Cargo: E5709R
- Women's Cargo: E5719R



Chest Pockets with Velcro



Dual Comm Wire Access



Flex Underarm Mesh

PRESTIGE WOOL BLEND DRESS UNIFORMS

Combining exceptional construction, comfort and design, the Prestige Wool-Blended Dress Uniforms cut an impressive figure. Made from a premium worsted wool blend.

Blousecoats

- Double-breasted style accommodates three to six buttons per vertical row on the blousecoats
- Features a full satin lining, shoulder pads and lined peak lapels
- Single-breasted style comes standard with removable silver-finish “FD” buttons. Additional options include gold or silver finish buttons with “P,” “FD” or “S”
- 55% Polyester/45% Worsted Wool, 2-Ply Serge Weave | Weight: 8.5 oz./sq. yard. Dry clean only.

Pants

- Unique machine-washable polyester/wool serge weave
- Flex waistband integrated with Elbeco’s Gripper Strip to keep shirts tucked in
- Two back pockets and extra-deep quarter-top front pockets offer convenient at-hand storage
- Triple-stitched crotch and double-ply crotch lining provide added comfort and durability
- Bar tacks at key stress points provide extra support
- Features pressed open, tailored seam construction
- 55% Polyester/45% Worsted Wool, 2-Ply Serge Weave | Weight: 8.5 oz./sq. yard. Dry clean only.



Midnight Navy:

Men’s Single-breasted: 1370

Men’s Double-breasted: 13750

Pants: E1360RN



TOP AUTHORITY DRESS UNIFORMS

An economical and easy-to-care-for alternative that will impress at any dress occasion, the Top Authority Dress Uniform offers increased comfort with a poly/serge weave fabric.

Blousecoats

- Double-breasted style accommodates three to six buttons per vertical row
- Single-breasted style comes standard with chest pockets and removable silver-finish “FD” buttons. Additional options include gold or silver finish buttons with “P,” “FD” or “S”
- Fully-lined with shoulder pads
- 100% Polyester Serge Weave | Weight: 7.0 oz./sq. yard

Pants

- Features extra deep quarter-top front pockets and back pockets with button tab on left
- Flex waistband integrated with Elbeco’s Gripper Strip to keep shirts tucked in
- Triple-stitched crotch prevents seam separation
- Machine-washable
- 100% Polyester Serge Weave | Weight: 7.0 oz./sq. yard

Midnight Navy:

Men’s Single-breasted: DC13800

Men’s Double-breasted: DC13820

Men’s Top Authority Pants: E8941RN

Men’s Top Authority Plus Pants: E8950RN

Men’s NJ/French Blue Stripe Pants: E8907RN

Men’s NJ 6-Pocket Pants: E8929R

Women’s Top Authority Pants: E8945LC

Women’s NJ 6-Pocket Pants: E8930LC

PARAGON PLUS POPLIN SHIRTS

Maintain a professional appearance all day, every day. Engineered for endurance, the Paragon Plus™ Shirts feature premium stretch poplin that won't fade. The Paragon Plus™ is thoughtfully designed for durability, quality and comfort.

- Permanent Nano Fluid Repellency allows fluids to bead and roll off fabric
- Stitched-in creases provide a classic military appearance
- Extra-long tails stay tucked in all day, even when you're active
- Sling badge tab allows for easy badge placement
- 65% Polyester/35% Cotton Poplin Weave | Weight: 4.25 oz./sq. yard



Midnight Navy:

- Men's LS: P824
- Men's SS: P834
- Women's LS: P844LC
- Women's SS: P854LC



White:

- Men's LS: P877
- Men's SS: P867
- Women's LS: P801LC
- Women's SS: P811LC



Blue:

- Men's LS: P878
- Men's SS: P868
- Women's LS: P802LC
- Women's SS: P812LC



EXPRESS DRESS SHIRTS

The Express™ Dress Shirts combine outstanding construction, strength and durability with traditional styling and unique features for a classic uniform shirt that looks and feels great all day long.

- Unique Broadcloth offers an exceptional professional appearance
- Extra-long tails keep the shirt tucked in throughout the day
- 65% Polyester/35% Cotton End-on-End Broadcloth | Weight: 4.0–4.25 oz./sq. yard



Blue:

- Men's LS: CA23
- Men's SS: CA03
- Women's LS: CA13
- Women's SS: CA33



FIRST RESPONDER SHIRTS

Designed for job-specific challenges, the First Responder Shirts are a high-quality alternative to the daily duty shirt. Featuring our premium poplin fabric with DTX fabric treatment for stain, soil and moisture repellency, and a casual yet professional design, this should be every first responder's go-to shirt for on-the-job comfort.

- Fabric treated for stain, soil and moisture repellency
- Flat pockets with mitered flaps and functional button closures
- Badge eyelets with internal support strap secure metal badge in place
- 65% Polyester/35% Cotton Poplin Weave I (Blue) Weight: 4.25 oz./sq. yard I (White) Weight: 4.9 oz./sq. yard



White:

Men's LS: 6000

Men's SS: 6010

Women's LS: 6020LC

Women's SS: 6030LC



Blue:

Men's LS: 6003

Men's SS: 6013

Women's LS: 6023LC

Women's SS: 6033LC



WEST COAST UNIFORMS

65/35 POLY/COTTON TWILL UNIFORMS

Elbeco's 65/35 Poly/Cotton Twill uniforms provide comfort and durability. These uniforms feature the natural wrinkle-resistance of polyester. Authorized by Los Angeles County Sheriffs.

Shirts

- Two plain pockets with mitered flaps and decorative button, hook and loop closure and pen opening in left pocket provide convenient at-hand storage
- Extra-long tails stay tucked in all day, even when you're active
- 65% Polyester/35% Cotton Twill | Weight: 6.5 oz./sq. yard

Pants

- ComfortStretch waistband keeps shirts tucked in
- Quarter top front pockets, two back pockets and two back billy pockets offer convenient at-hand storage
- Double-ply crotch lining provide added comfort and durability
- 65% Polyester/35% Cotton Twill | Weight: 8.0 oz./sq. yard



Tan:

Men's LS: 4532 Women's LS: 4533
Men's SS: 4530 Women's SS: 4531



Forest Green:

Men's LS: 4656N Women's SS: 4655
Men's SS: 4654N Men's Pants: E829RN
Women's LS: 4567 Women's Pants: E9829N



65/35 POLY/RAYON SHIRTS

Engineered for superior color retention and absorption, this shirt is authorized by the California Highway Patrol and other agencies.

- Cross-stitched shoulder straps with functional button for mic attachment
- Plain double-needle rounded pockets with scalloped flaps, hook and loop closure and pen opening in left pocket provide convenient at-hand storage
- 65% Polyester/35% Rayon/2-ply Tropical Weave | Weight: 6.0 oz./sq. yard



Tan:

Men's Poly/Rayon LS: 247N
Men's Poly/Rayon SS: 248N
Women's Poly/Rayon LS: 8697N
Women's Poly/Rayon SS: 8687N





Concealed Zipper
Front on
Heavyweight Style

100% WOOL UNIFORMS

100% premium worsted wool tropical weave and serge weave gives these uniforms superior comfort and quality. Authorized by LAPD and other agencies.

Shirts

- Plain double-needle rounded pockets with scalloped flaps, hook and loop closure and pen opening in left pocket provide convenient at-hand storage
- Elongated badge tab and metal eyelets
- 100% Worsted Wool Tropical Weave | Weight: 6.6 oz./sq. yard | 10-10.5 oz./linear yard
- Heavy Weight Style 100% Worsted Wool 2-Ply Serge Weave | Weight: 10-10.5 oz./sq. yard | 17-17.5 oz./linear yard

Pants

- SnugTex waistband with reinforced hook and eye closure keeps shirt tucked in
- Straight front pockets, two back billy pockets, two back hip pockets, and watch pocket provide convenient at-hand storage
- 100% Worsted Wool 2-Ply Serge Weave | Weight: 10-10.5 oz./sq. yard | 17-17.5 oz./linear yard

Midnight Navy:

Men's LS: 437

Men's SS: 4237

Women's LS: 537

Women's SS: 5237

Men's Heavyweight LS: Z4777

Men's Heavyweight SS: Z4797

Men's Pants E8931R

Women's Pants: E8932LC

55/45 POLY/WOOL UNIFORMS

These Class A uniforms are authorized by the LA County Sheriff and California Highway Patrol. They're engineered with a polyester worsted wool blend to give you comfort and durability.

Shirts

- Cross-stitched shoulder straps with functional button for mic attachment
- Top-fused collar with internal stays and satin lined band and inner yoke for comfort
- Plain double-needle rounded pockets with scalloped flaps and decorative button, hook and loop closure and pen opening in left pocket provide convenient at-hand storage
- 55% Polyester/45% Worsted Wool 2-Ply Serge Weave | Weight: 5.0 oz/sq. yard
- Heavy Weight Style 55% Polyester/45% Worsted Wool 2-Ply Gabardine Weave | Weight: 6.75 oz/sq. yard | 11.5 oz/linear yard

Pants

- SnugTex waistband keep shirt tucked in
- Double-ply crotch lining for comfort and durability
- Two back pockets with button tab on left, two back billy pockets, and watch pocket provide convenient at-hand storage
- 55% Polyester/45% Worsted Wool/Elastique | Weight: 9.6 oz./sq. yard | 16.5 oz./linear yard



Tan:

Men's LS: 7064N

Men's SS: 5030

Women's LS: 7122N

Women's SS: 5031

Men's Heavyweight Poly/Wool LS: 436N

Men's Heavyweight Poly/Wool SS: 7157N



CA Green:

Men's Pants: E8149R

Women's Pants: E8150

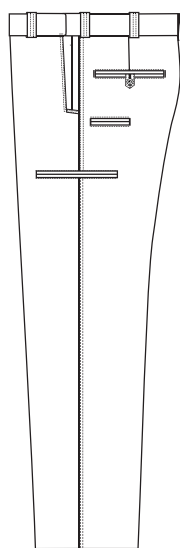

Hidden
Cargo

—NEW—

PRESTIGE WOOL BLEND HIDDEN CARGO POCKET PANT

Made from machine-washable 75/25 poly/wool twill, the Prestige pant offers the functionality and comfort of a tactical pant with the professional appearance and performance of a wool blended fabrication. With similar design as our Reflex hidden cargo pant including notched front pockets, hidden cargo pockets, and a flex waistband.

- Covert flex waistband provides 2" stretch
- Hidden Cargo style offers multiple storage options
- Diamond-shaped crotch gusset on men's pants for comfort and mobility
- 75% Polyester / 25% Wool Twill

O.D. Green:

Men's Hidden Cargo: E8449R

Women's Hidden Cargo: E8450LC

FLEXTECH BASE LAYERS

FlexTech™ Base Layers combine thoughtful design and innovations. A blend of cotton and spandex, the 4-way stretch fabric provides outstanding range of motion, comfort and fit.

- 4-way stretch fabric enhances range of motion, comfort and fit
- UV protection reduces damage from the sun
- Antimicrobial technology reduces the buildup of odor-causing bacteria
- Permanent Nano Wicking technology pulls moisture away from the body for quick-dry comfort
- 96% Cotton/4% Spandex 4-way stretch knit | Weight: 5.3 oz./sq. yard



Midnight Navy:

FlexTech Mock T-Neck: K8004 FlexTech Mock T-Neck Dickie: K8034
FlexTech T-Neck: K8014 FlexTech T-Neck Dickie: K8024



Black:

FlexTech Mock T-Neck: K8000 FlexTech T-Neck Dickie: K8020
FlexTech Mock T-Neck Dickie: K8030



UFX BASE LAYERS

Ufx™ Base Layers provide a comfortable experience, all day, every day. The abrasion-resistant, 4-way PowerStretch fabric enhances range of motion.

- 4-way stretch fabric enhances range of motion, comfort and fit
- UV protection reduces damage from the sun
- Antimicrobial technology reduces the buildup of odor-causing bacteria
- Permanent Nano Wicking technology pulls moisture away from the body for quick-dry comfort
- 63% Nylon/23% Micro Polyester/14% Spandex Knit | Weight: 6.5 oz./sq. yard



Midnight Navy:

UFX Mock T-Neck: 8924



Black:

UFX Mock T-Neck: 8920

REGULATION BASE LAYERS

Regulation™ Base Layers are thoughtfully designed for superior quality and comfort. The 100% combed cotton jersey knit is vat-dyed for consistent, long-lasting color.

- Seamless neck, cuffs and body enhance durability and provide a professional appearance
- Spandex memory prevents collar and cuffs from stretching out
- Body Fabric: 100% Combed Cotton Jersey Knit | Weight: 6.0 oz./sq. yard
- Neck and Cuffs Fabric: 95% Cotton/5% Lycra Rib Knit | Weight: 7.5 oz./sq. yard



Midnight Navy:

Regulation Mock T-Neck: 8600
Regulation T-Neck: 7700



OUTERWEAR

FLEXTECH JACKETS

Innovation meets tradition. At the station or in the field, the Shield FlexTech™ Jackets offer unparalleled versatility and comfort. Made of breathable, 4-way stretch polyester microfleece with permanent Nano Fluid Repellency, this jacket provides enhanced protection and performance.

- Available in full- and quarter-zip
- Dual fleece-lined side hand warmer pockets include internal storage pockets and D-ring
- Roomy, adjustable chest pocket to accommodate a full-sized radio
- Permanent Nano Fluid Repellency allows fluids to bead and roll off fabric
- 100% Polyester Microfleece | Weight: 8.0 oz./sq. yard

Midnight Navy:

Full Zip Jacket: 3764/T3764

Quarter Zip Job Shirt: 3774/T3774





JOB SHIRTS

Loaded with enhancements for optimal utility, the Shield Job Shirts are as functional and durable as they are comfortable! Made from heavyweight cotton-blended fleece, our job shirts feature quarter-zip front closure with abrasion-resistant chin guard. Perfect for wear around the station or in the field.

- Dual fleece-lined side hand warmer pockets include internal storage pockets and D-ring
- Roomy, adjustable chest pocket to accommodate a full-sized radio
- Available in self collar or twill collar with elbow patches in our Tek3™ fabric
- 82% cotton/18% Polyester Heavyweight Fleece | Weight: 11.5 oz./sq. yard

Midnight Navy:

Self Collar: 3730/T3730

Twill Collar: 3732/T3732



Roomy Side Pocket with D-ring



Mic Pockets



Mic / Sunglasses Loop





Pen Pocket

DUTY JACKET

Get intense protection from the elements. The Shield Duty Jacket is a fully seam-sealed breathable poly RipStop shell that's wind and waterproof. Designed to protect under any conditions, the Duty Jacket is loaded with innovations for enhanced protection, performance and comfort in any weather.

- Two Concealed-Carry utility chest pockets with magnetic closures offer easy access when needed
- 10 functional pocket storage options provide enhanced utility
- Three-piece waterproof hood with drawcord retracts flat into zipper compartment when not in use
- 3-in-1 system zipper track allows the Performance and Color Block Soft Shells to be zipped into the Duty Jacket
- 100% Polyester mini RipStop with windproof, waterproof, breathable Hydrotech membrane on nylon taffeta substrate | Weight: 4.0 oz./ sq. yard



		
Midnight Navy: SH3204	Black: SH3200	O.D. Green: SH3209

SAFETY DROP DOWN PANELS AVAILABLE

BLANK (HIVIS): F3216SH
BLANK (BLACK): F3210SH
BLANK (MIDNIGHT NAVY): F3214SH
BLANK (OD GREEN): F3219SH
BLANK (BROWN): F3215SH

POLICE (DARK NAVY): F3224SH
POLICE (HIVIS): F3226SH
SHERIFF (BLACK): F3230SH
SHERIFF (HIVIS): F3236SH

DUTY PARKA

Stay warm, dry and comfortable in any weather. The Shield Duty Parka Jacket is a lightweight, poly RipStop outer shell that's wind- and waterproof. Featuring a breathable Hydrotech membrane and a removable Thinsulate™ liner, this jacket provides superior protection and versatility no matter the conditions.

- Removable Thinsulate™ liner offers added flexibility in any weather
- Three-piece waterproof hood with drawcord retracts flat into zipper compartment for convenient storage
- Large fleece-lined hand warmers/top entry pockets with internal compartments and mitered flaps offer protection from wind and cold
- 100% Polyester Mini RipStop with waterproof, windproof, breathable Hydrotech membrane on Nylon Taffeta Substrate | Weight: 4.0 oz./sq. yard

Midnight Navy: SH3304P





—NEW—

PINNACLE JACKET

The Pinnacle jacket is the next evolution of the Shield Outerwear series. The Nanospun 4-way stretch fabric technology creates micro pores that let air and perspiration out, with high stretch polyester fibers with Nano fluid repellency making for an extremely lightweight wind/waterproof breathable shell. Features include a snap-off hood and drop-down panels, adjustable cuffs, fully taped seams, and quick-release side zipper vents.

- Easy access front and back drop-down ID panels.
- The snap-off contoured hood keeps moisture and wind out while providing excellent peripheral vision.
- Waterproof front zipper provides total protection against the elements
- Dual quick access side vents provide easy access to equipment and duty belt
- 100% brushed Polylux polyester
Nanospun 4 way stretch technology |
Weight: 4.0 oz./ sq. yard



Midnight Navy:
SH3104



Black:
SH3100



PERFORMANCE SOFT SHELL

Windproof and waterproof, the Shield Performance Soft Shell offers superior functionality, breathability and comfort. It's designed to be worn as a stand-alone jacket or as a mid-layer that can be combined with the Shield Duty Jacket for a 3-in-1 total jacket system.

- Two-way stretch fabric offers enhanced range of motion
- Dual concealed-carry/utility chest pockets with magnetic closures offer quick access when needed
- Large fleece-lined hand warmer pockets with zipper closures and D-ring keep you comfortable in any weather
- Dual quick access side vents provide easy access to equipment and duty belt
- 2-way stretch woven 96% polyester / 4% spandex exterior with fleece interior and windproof, waterproof, breathable Hydrotech membrane | Weight: 7.6 oz./sq. yard



Midnight Navy:
SH3504



Black:
SH3500



O.D. Green:
SH3509



Quick Release Side
Zipper Vents

GENESIS JACKET

Featuring a windproof and waterproof Hydrotech membrane, the Shield Genesis Jacket offers outstanding protection, performance and comfort. This breathable and durable jacket provides improved functionality and range of motion.

- Removable Thinsulate™ liner offers added flexibility in any weather
- Three-piece waterproof hood with drawcord retracts into zipper compartment for convenient storage
- Dual quick access side vents provide easy access to equipment and duty belt
- 100% Polyester Mini RipStop with windproof, waterproof, breathable Hydrotech membrane | 4.0 oz./sq. yard



Midnight Navy:
SH3804



Black:
SH3800



Brown:
SH3805



HIVIS REVERSIBLE JACKET

Stay dry, warm, agile and visible no matter the conditions. The Shield HiVis Reversible Jacket is a poly RipStop shell loaded with innovative features for enhanced performance, protection and comfort. Need to be seen? It quickly reverses to a HiVis microfleece soft shell for ANSI-certified night time and low light visibility safety.

- Two-way stretch fabric offers enhanced range of motion
- Dual concealed-carry/utility chest pockets with zipper closures offer quick access when needed
- Large fleece-lined hand warmer pockets with zipper closures and D-ring keep you comfortable in any weather
- HiVis side is ANSI107-2010 Class 2 Level 2 certified; eligible for Homeland Security and Fire Act grant programs as PPE
- Navy Side Fabric: 100% Polyester Mini RipStop | Weight 4.0 oz./sq. yard
- HiVis Side Fabric: 2-Way Stretch microfleece 96% Polyester/4% Spandex Shell | Weight 7.6 oz./sq. yard



HiVis / Navy:
SH3724RV



D-Ring in Right Pocket 3M Patterned Striping



COLOR BLOCK SOFT SHELL

Stay warm, dry and agile in any conditions, day or night. A stretch microfleece soft shell, the Shield Color Block Soft Shell is fully-loaded with features for superior performance, protection and comfort. Designed to be worn as a stand-alone outer garment or as a mid-layer liner combined with our Shield Duty for 3-in-1 seasonality protection.

- Two-way stretch microfleece fabric offers enhanced range of motion
- Dual concealed-carry/utility chest pockets with zipper closures offer quick access when needed
- Large fleece-lined hand warmer pockets with zipper closures and D-ring keep you comfortable in any weather
- Can be used as a zip-in liner with Shield Duty Jacket or HiVis Parka
- 2-Way Stretch Woven 96% Polyester/4% Spandex exterior with fleece interior and windproof, waterproof, breathable Hydrotech membrane | Weight: 7.6 oz./sq. yard



Navy / Royal Blue:
SH3703BN



Navy / Red:
SH3704RN



HiVis / Black:
SH3708HV



HIVIS PARKA

Our Shield HiVis Parka, ANSI 107-2010 Class 3 Certified outerwear system, allows you to be seen in any weather or light. Includes heat-sealed 3M patterned reflective striping, a wind- and waterproof Hydrotech membrane, extra-long back and three-piece waterproof hood.

- Zipper track accommodates Performance soft shells
- 7 functional pockets offer generous storage and utility
- Articulated elbows and adjustable hook-and-loop storm cuffs offer enhanced agility and range of motion
- 100% Polyester Oxford bonded with protective coating and waterproof, windproof, breathable Hydrotech membrane on Nylon Taffeta Substrate | Weight: 6.0 oz./sq. yard



HiVis / Navy:
SH3404



Three-Piece
Waterproof Hood



Magnetic Pocket
Closures



HIVIS SAFETY VEST

The Shield HiVis Safety Vest provides unmatched visibility. This ANSI-certified Type P Class 2 vest is made from breathable high visibility mesh fabric and features 3M™ Scotchlite reflective striping for 360-degree day/night reflective coverage. Our innovative reflective black lettering allows the optional “Police” or “Sheriff” lettering to illuminate in even low visibility environments; no other safety vest on the market offers this.

- Five-point breakaway design with hook-and-loop fasteners to prevent entanglement
- Front and back accommodate two rows of custom lettering
- Microphone tabs on upper chest
- 100% Polyester | 3.5 oz./sq. yard

HiVis:

Blank: SH3900V

Police: SH3901V

Sheriff: SH3902V





This document is meant to be used as a guide in determining suitable size options available & should not replace an actual garment fitting. Upon receipt of the garment, we recommend that it be tried on by the intended wearer to ensure proper fit prior to making any alterations.

We recommend the following in order to determine the most suitable size option:

Keep the ballistic panels inside the carrier when measuring.

Measure the full amount of both the ballistic panels and the excess fabric bulk created by the panel carrier

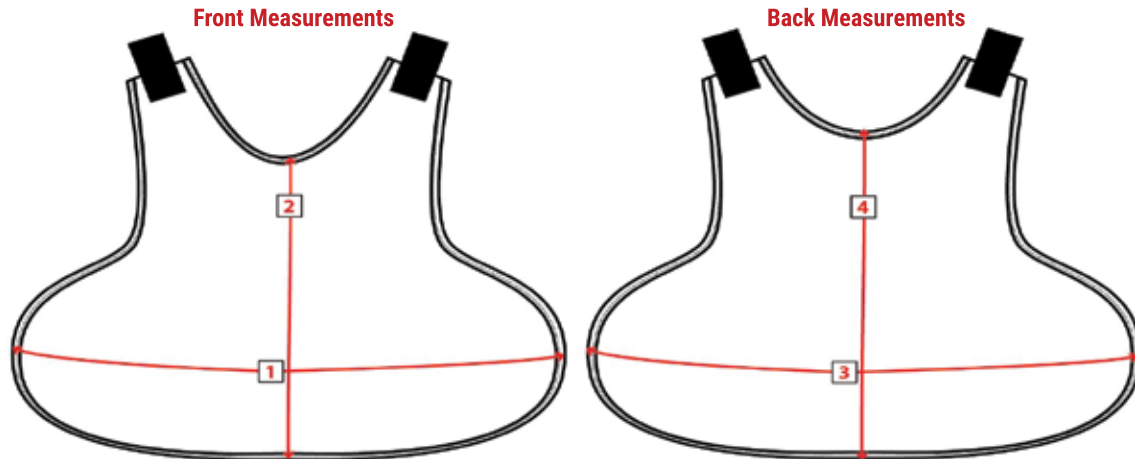

HOW TO MEASURE

1	Front Panel Width	With cloth tape measure, measure the ballistic carrier at the widest point of the body of the front panel. This point should fall between the bottom of the armhole & the waistline of the carrier.
2	Front Panel Height	With cloth tape measure, measure the front height of the ballistic carrier from the center front neckline to the waistline.
3	Back Panel Width	With cloth tape measure, measure the ballistic carrier at the widest point of the body of the back panel. This point should fall between the bottom of the armhole & the waistline of the carrier.
4	Back Panel Height	With cloth tape measure, measure the back height of the ballistic carrier from the center back neckline to the waistline.

FIT GUIDE BASED ON BALLISTIC CARRIER MEASUREMENTS

		Height	XS	S	M	L	XL	2XL	3XL
1	Front Panel Width	Short		19	21	23			
		Regular	19	21	23	25	27	29	31
		Long		22	24	26	28	30	32
		X-Long				27	29	31	33
2	Front Panel Height	Short		11 1/8	12 1/8	12 5/8			
		Regular	11 5/8	12 5/8	13 5/8	14 1/8	15 1/8	15 5/8	15 7/8
		Long		14 1/8	15 1/8	15 5/8	16 5/8	17 1/8	17 3/8
		X-Long				17 1/8	18 1/8	18 5/8	18 7/8
3	Back Panel Width	Short		20 3/4	22 3/4	24 3/4			
		Regular	20 3/4	22 3/4	24 3/4	26 3/4	28 3/4	30 3/4	32 3/4
		Long		23 3/4	25 3/4	27 3/4	29 3/4	31 3/4	33 3/4
		X-Long				28 3/4	30 3/4	32 3/4	34 3/4
4	Back Panel Height	Short		15 1/4	16 1/4	16 3/4			
		Regular	15 3/4	16 3/4	17 3/4	18 1/4	19 1/4	19 3/4	20
		Long		18 1/4	19 1/4	19 3/4	20 3/4	21 1/4	21 1/2
		X-Long				21 1/4	22 1/4	22 3/4	23

For more information please contact your local Sales Representative or Customer Service at 800-468-4654 and visit us at www.elbeco.com

Stock size availability charts are available at elbeco.com.

PRODUCT CODE INDEX

1370.....23	5627LC.....22	CAP30.....11	E8876LC.....16	K5134.....5	P4MAGSNG....8	Z3314N.....15
3730.....34	5629LC.....22	CAP34.....11	E8903RN.....16	K5135.....3	P4RADIO.....8	Z3315N.....15
3732.....34	5640LC.....22	DC13800.....24	E8904LC.....16	K5136.....3	P4STNGUN....8	Z4777.....28
3764.....33	5642LC.....22	DC13820.....24	E8905RN.....16	K5137.....3	P4UTIL.....8	Z4797.....28
3774.....33	5644LC.....22	E1360RN.....23	E8906LC.....16	K5138.....3	P801LC.....25	Z9315LCN....15
4237.....28	5647LC.....22	E224RND.....17	E8907RN.....24	K5139.....3	P802LC.....25	Z9810LCN....15
437.....28	5649LC.....22	E234RND.....17	E8909PB.....16	K5140.....3	P811LC.....25	Z9814LCN....15
4420.....11	580D.....17	E245RN.....17	E8910LCP.....16	K5141.....3	P812LC.....25	Z9815LCN....15
4424.....11	581D.....17	E254RND.....17	E8911RN.....16	K5142.....3	P824.....25	
4440.....11	582D.....17	E255RN.....17	E8912LC.....16	K5143.....3	P834.....25	
4444.....11	584D.....17	E2804R.....20	E8929R.....24	K5144.....3	P844LC.....25	
4530.....27	586D.....17	E2814LCD....20	E8930LC.....24	K5145.....3	P854LC.....25	
4531.....27	589D.....17	E2824.....20	E8931R.....28	K5146.....3	P867.....25	
4532.....27	592D.....17	E2834LC.....20	E8932LC.....28	K5148.....3	P868.....25	
4533.....27	6020LC.....26	E2844R.....20	E8941RN.....24	K5149.....3	P877.....25	
4655.....27	6023LC.....26	E2854LC.....20	E8945LC.....24	K5151.....3	P878.....25	
4657.....27	6030LC.....26	E2874R.....20	E8950RN.....24	K5152.....3	QKCLPBLK....8	
5030.....29	6033LC.....26	E2884LC.....20	E8960R.....16	K5162LC.....3	QKCLPTAN....8	
5031.....29	7064N.....29	E314RN.....16	E8961LC.....16	K5170LC.....3	SH3100.....36	
5237.....28	7122N.....29	E315RN.....16	E9025R.....20	K5172LC.....3	SH3104.....36	
537.....28	7157N.....29	E320RN.....16	E9026LC.....20	K5174LC.....3	SH3200.....35	
5610.....22	840N.....13	E390R.....16	E9027R.....20	K5177LC.....3	SH3204.....35	
5612.....22	841N.....13	E394R.....16	E9224LCD....17	K5178LC.....3	SH3209.....35	
5614.....22	850N.....13	E4024R.....14	E9234LCD....17	K5179LC.....3	SH3304P.....35	
5615.....22	8687N.....27	E4025LC.....14	E9245LC.....17	K5180LC.....3	SH3404.....39	
5617.....22	8697N.....27	E4030RN.....14	E9254LCD....17	K5181LC.....3	SH3500.....37	
5619.....22	8802LC.....15	E4031LCN....14	E9255LC.....17	K5182LC.....3	SH3504.....37	
5630.....22	8803N.....15	E4040R.....14	E9314LC.....20	K5184LC.....3	SH3509.....37	
5632.....22	8804LC.....15	E4041LC.....14	E9315LC.....20	K5188LC.....3	SH3703BN...39	
5634.....22	8805N.....15	E440R.....14	E9320LC.....20	K5189LC.....3	SH3704RN...39	
5635.....22	8840N.....15	E444R.....14	E9390LC.....20	K5213.....5	SH3708HV...39	
5637.....22	8841N.....15	E454R.....14	E9394LC.....20	K5214.....5	SH3724RV...38	
5639.....22	8850N.....15	E490R.....14	E9440LC.....14	K5216.....5	SH3800.....37	
6000.....26	9310LCN....15	E494RN.....14	E9444LC.....14	K5223.....5	SH3804.....37	
6003.....26	9311LCN....15	E5700R.....22	E9454LC.....14	K5224.....5	SH3805.....37	
6010.....26	9312LCN....15	E5702R.....22	E9490LC.....14	K5226.....5	SH3900V....40	
6013.....26	9313LCN....15	E5704R.....22	E9494LCN...14	K5234.....5	SH3901V....40	
8920.....31	9314LCN....15	E5705R.....22	E9615LCN...20	K5274LC.....5	SH3902V....40	
8924.....31	9319LCN....15	E5707R.....22	E9619LCN...20	K6401.....4	T3730.....34	
13750.....23	9320LCN....15	E5709R.....22	E9620LCN...20	K6404.....4	T3732.....34	
247N.....29	9340LCN....15	E5710LC.....22	E9815LCH...20	K6408.....4	T3764.....33	
248N.....29	9341LCN....15	E5712LC.....22	E9820LC.....20	K6411.....4	T3774.....33	
310N.....15	9350LCN....13	E5714LC.....22	E9829N.....27	K6414.....4	UVS101.....9	
311N.....15	9580LCD....17	E5715LC.....22	F3210SH.....35	K6418.....4	UVS102.....9	
312N.....15	9581LCD....17	E5717LC.....22	F3214SH.....35	K8000.....31	UVS103.....9	
313N.....15	9582LCD....17	E5719LC.....22	F3215SH.....35	K8004.....31	UVS104.....9	
314N.....15	9584LCD....17	E5724R.....22	F3216SH.....35	K8014.....31	UVS105.....9	
319N.....15	9586LCD....17	E5734LC.....22	F3219SH.....35	K8020.....31	UVS106.....9	
320N.....15	9589LCD....17	E615RN.....20	F3224SH.....35	K8024.....31	UVS107.....9	
3310N.....15	9592LCD....17	E619RN.....20	F3226SH.....35	K8030.....31	UVS108.....9	
3311N.....15	9780LCD....17	E620RN.....20	F3230SH.....35	K8034.....31	UVS113.....9	
3312N.....15	9781LCD....17	E7340R.....12	F3236SH.....35	P0FLSHLG....8	UVS114.....9	
3313N.....15	9782LCD....17	E7344R.....12	G920NP.....19	P0FLSHSM....8	UVS117.....9	
3314N.....15	9784LCD....17	E7350LC.....12	G9220NP.....19	P0HANDCF....8	UVS118.....9	
3319N.....15	9786LCD....17	E7354LC.....12	G924.....19	P0MACE.....8	UVS121.....9	
3320N.....15	9789LCD....17	E7360R.....12	G934.....19	P0MAGDBL...8	UVS122.....9	
436N.....29	9792LCD....17	E7364R.....12	G944LC.....19	P0MAGSNG...8	UVS151.....9	
4430LC.....11	9810LCN....15	E7370LC.....12	G954LC.....19	P0RADIO.....8	UVS152.....9	
4434LC.....11	9811LCN....15	E7374LC.....12	G965NP.....19	P0STNGUN...8	UVS204.....10	
4450LC.....11	9812LCN....15	E7380.....12	G968NP.....19	P2FLSHLG....8	V3110B.....7	
4454LC.....11	9813LCN....15	E7384.....12	G975NP.....19	P2FLSHSM....8	V3112B.....7	
4654N.....11	9814LCN....15	E7390LC.....12	G978NP.....19	P2HANDCF....8	V3114B.....7	
4656N.....11	9819LCN....15	E7394LC.....12	G988LCP.....19	P2MACE.....8	V3115B.....7	
5580D.....17	9820LCN....15	E7552RN.....20	G998LCP.....19	P2MAGDBL...8	V3117B.....7	
5581D.....17	9840LCN....15	E7553LCN...20	K5100.....5	P2MAGSNG...8	V3124WCB...7	
5582D.....17	9841LCN....15	E8149R.....29	K5102.....5	P2RADIO.....8	VSS1.....8	
5584D.....17	9850LCN....15	E8150.....29	K5103.....5	P2TASER.....8	Z310N.....15	
5586D.....17	CA03.....26	E815RNH...20	K5104.....5	P4FLSHLG....8	Z312N.....15	
5589D.....17	CA13.....26	E820RN.....20	K5124.....5	P4FLSHSM....8	Z314N.....15	
5592D.....17	CA23.....26	E829RN.....27	K5130.....5	P4HANDCF....8	Z315N.....15	
5620LC.....22	CA33.....26	E8449R.....30	K5131.....5	P4MACE.....8	Z3310N.....15	
5622LC.....22	CAP10.....20	E8450LC.....30	K5132.....5	P4MAGDBL...8	Z3311N.....15	
5624LC.....22	CAP24.....20	E8875RN.....16	K5133.....5	P4MAGDBN...8	Z3312N.....15	



elbeco

Specialty Apparel for:
Law Enforcement / Corrections / Fire & EMS / Postal / Transportation

www.elbeco.com | 1.800.468.4654