

BERTRAM

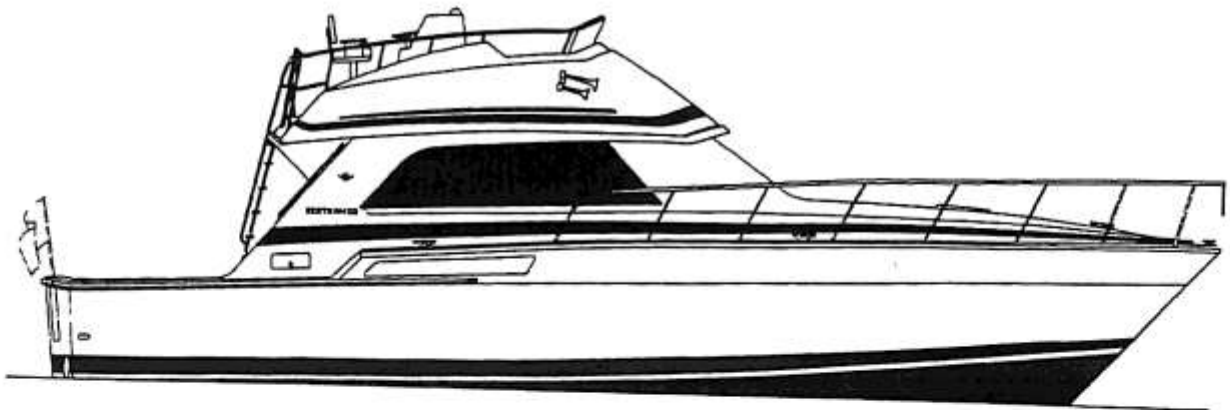

MODEL: 50 CONVERTIBLE

OPERATOR'S MANUAL

Table of Contents

1	Foreword.....	1
2	Glossaries	4
3	Technical Data	15
	Vessel Specifications.....	15
	Main Engines and Transmissions	16
	Engine Batteries.....	17
	Propellers.....	17
	Propeller Shafts & Couplings	17
	Diesel Generator	18
	Fuel Remaining In Tanks	19
	Ventilation And Exhaust Blowers.....	19
	Bilge And Sump Pumps	19
4	Equipment Location	20
	General.....	20
	Fuel System	20
	Fresh Water System.....	21
	Shower Sump System	21
	Bilge Pump System	22
	Blowers	22
	Air Conditioning System.....	23
	Monitor Systems (except fire extinguishing).....	24
	Fire System	25
	Toilet System	25
	Seawater pump system	26
	Cablemaster	26
	Trim tabs	26
	Batteries	26
	Engines & A.C. Generator(s)	26
	Lube Oil Transfer System	26

5 Carbon Monoxide (co) Gas	27
6 Fire Monitor And Extinguishing Systems	29
General	29
Engine Room Fire Monitor (Overheat Detection) System	30
Engine Room Fixed Fire Extinguisher System.	31
System Operation	32
After Discharge of the Fire System	33
Inspection and Restarting Boat Systems	34
Fixed Fire Ext. Maintenance	35
Using the Portable Fire Extinguishers	35
Portable Fire Ext. Maintenance	36
Classes of Fires.	36
The Fire Fighting Plan	37
Fire Or Emergency Evacuation Plan	38
7 Engine Control Stations & Maneuvering	39
General	39
Control Stations	39
General	39
Flybridge(MainHelm) Navigation and Engine Control Station	39
Cockpit Engine Control Station (Custom).	40
Speed And Maneuvering Controls.	40
General	40
Throttle Controls	41
Forward/Neutral/Reverse Transmission Controls	41
Boat Speed	41
Maneuvering	42
Slow Speed Maneuvering.	42
Cruising Speed Maneuvering.	42
8 Propulsion System.	44
General	44
Propulsion System Care.	44
The Diesel Engines	45
Engine Operation	46
Preparing To Start the Main Diesel Engines	46

Diesel Engine Starting Procedure	47
After the Engine Starts	48
Stopping the Main Diesel Engines	48
Fuel System	49
General	49
Fuel tanks, Valves, & Tank Selection	49
Fuel Filtering	49
Fuel Priming System	50
Fuel Fill Ports	50
Fuel Gallonage & Gauges	50
Fuel Quality	50
Spoiled Fuel	51
Engine Air System	51
Airsep Filters	52
Engine Lubrication System	54
Engine Cooling	55
General	55
Fresh Water and Anti-freeze Mixture	55
Seawater Inlet System	56
Wet Exhaust System	57
Marine Gears	57
General	57
Operation	57
Propellers	58
General	58
Changing Propellers	58
Propeller Shafts	58
Propeller Shaft Alignment	58
Parallel or Bore Misalignment	58
Angular or Face Misalignment	59
Allowable Angular or Face Misalignment	59
Propeller Installation	60
Propeller Shaft Replacement	62
General	62
Coupling Removal	62
Coupling Installation	63
Shaft Log And Stuffing Box	64
The Shaft Log	64
Stuffing Boxes	64
Repacking a Stuffing Box	65

Shaft Log Sprayshield	65
Rudder Stuffing Boxes	65
Engine Performance Gauges & Monitor System	66
General	66
Engine Performance Gauges	67
Engine Coolant Temperature Gauges	67
Engine Lube Oil Pressure Gauges	67
Gear Oil Temperature Gauge	67
Gear Oil Pressure Gauge	67
D.C. Voltage Gauge	67
The Tachometer	68
Engine Performance Monitor System	69
Engine Monitor Operation	69
Engine Monitor Trouble Shooting	70
9 D.C. Electrical System	72
General	72
Battery Banks	72
D.C. Power Distribution	72
D.C. Main Supply Panel	72
D.C. Distribution Panel	73
D.C. Equipment Protection	73
Battery Disconnect Switches	74
Battery Paralleling Systems	74
12/24V D.C. Voltage Equalizer for DDEC	75
D.C. DDEC Power Source Panel	77
10 A.C. Electrical System	78
General	78
A.C. Distribution Panel	78
Shore-Generator Power Selector	79
Generator Controls	79
Circuit Distribution	79
Loss of Power	79
A.C. Generator System	79
Before Starting the generator	80
Starting the Generator	80
Stopping the Generator	81

A.C. Shore Power	81
The Shore Power	82
Circuit Protection	82
Ground Fault Circuit Interrupters (G.F.C.I.).....	83
General	83
GFCI Outlet Operation	83
International Shore Power	84
Automatic Converters	84
Galvanic Isolator	84
11 Air Conditioning System	86
General	86
Condensing Units	86
Air Conditioning Controls.....	86
Seawater Cooling System	86
Air Conditioning Operation.....	87
12 Toilet (Head) System	88
General	88
Toilet System Operation	90
Inside U.S. Territorial Waters	90
Outside U.S. Territorial Waters.....	91
Flushing	91
Holding Tank Monitor & Pump-out	91
13 Fresh Water System, Sump Pump & Monitor	93
General	93
Fresh Water Tank	93
Water Pump	94
Water Heater	95
Showers	95
Gray Water Tank (Shower Sump) & Pump	96
Gray Water Tank Monitor.....	96
Galley Sink And Lavatory Sinks.....	97
Engine/generator Cooling Water.....	97
Dockside Water Supply.....	97

14 Bilge Pump Systems	98
General	98
Bilge Pump Locations	99
Bilge Pump System Operation	99
Pump Maintenance	100
Emergency Bilge Pump, Main Engine	100
 15 Ventilation Systems	 103
Ventilation Systems	103
General	103
Engine Compartment Ventilation	103
Stateroom Ventilation	104
Toilet (Head) and Shower Ventilation	104
Galley Ventilation	104
 16 Systems & Accessories	 105
General	105
Telephone System	105
Seawater Washdown System	105
Description	105
Seawater Washdown System Operation	106
Windlass (optional)	106
General	106
Operation	106
Cablemaster Shore Cord Retractor	107
Central Vacuum System	108
Operation	108
Swimming Platform	109
Searchlight (Optional)	109
Navigation And Running Lights	110
Docking Lights Switches (optional)	111
Overhead Rod Locker	111
Steering Control System	111
The Trim Tab Controls	113
Trim Tab Maintenance	114

17 General Maintenance	115
Battery Care	115
Distilled Water	115
Filling Procedure	115
Excessive Loss of Liquid	115
Battery Gases - Explosive Hazard	116
Spilled Battery Acids	116
Diesel Fuel	117
Electrical Repairs	117
Cockpit Hatch Dog Adjustment	118
Nonfiberglass Plastics	119
General	119
Acrylic	119
ABS Plastics	120
Oil or Fuel-Soaked Rags & Wipes	120
Crevice Corrosion	120
Galvanic Corrosion	121
Galvanic & Stray Current Bonding (Grounding) System	121
18 Fiberglass Care	122
General	122
Seasonal Care (at fitting out time)	122
Loss of Gloss	122
Stains	123
Scratches & Abrasions	123
Painting Fiberglass Surfaces	124
Bottom Anti-fouling Paint	124
General	124
Before Applying Anti-Fouling Paint	125
Bottom Blisters	125
19 General Subjects	126
General	126
Hull Efficiency	126
Atmospheric Conditions	126
Marine Growth	127
Water In The Bilge	127

Damaged Underwater Equipment	127
Draft	128
Height	128
Compass	128
General	129
Compass Construction	130
Compass Error	130
Trip Preparation	132
The Fishing Tower	133
Propeller Hazard	134
When Underway	134
Preparations For Rough Weather	135
The Beaufort Scale Of Wind Force	137
Running Aground	137
Recommendations For Refloating Vessel	138
Flotsam (floating Debris)	139
Vibrations	139
Towing	139
General	139
Personnel Safety	140
Use Of Personal Flotation Devices	140
Ring Buoy	141
Radios As Emergency Equipment	141
Visual Distress Signals	142
Sound Signals	142
Calling At Ports Away From Home	142
Leaving Your Bertram	143
20 Diagrams	144
Docking Plan	144
Electrical Drawings	144
Mechanical flow Diagrams	144
Index	145

1. Foreword

NOTE:

Do not attempt to operate this vessel until you are thoroughly familiar with the contents of this manual and all of your vessel's on-board systems. Included in this manual are the appropriate warnings, cautions, operating, and some maintenance information for your Bertram's on board systems. Additional maintenance information for the systems is placed on-board under separate cover.

Congratulations!

Your Bertram's unique design and the care taken in its manufacturing mean it should give you outstanding performance and many years of boating pleasure. Your Bertram is built of the finest materials, hand crafted to Bertram's demanding quality standards. It is factory tested and thoroughly inspected.

As durable as it is, your Bertram will benefit from reasonable care. A yacht is a complex mechanism, and it will require preventive and corrective maintenance, minor adjustments, and repairs. This operator's manual helps explain the operation and required maintenance of the many systems on your yacht.

The better you understand your Bertram, the more pleasure you will get from it. We recommend that you read this manual thoroughly and keep it on board for reference. If any points are not clear, your Bertram dealer will be glad to assist you.

This manual is not intended to replace years of boating experience or the excellent classes on safe boating taught by the U. S. Coast Guard Auxiliary and the U.S. Power Squadron. We have included material that covers some aspects of safe boating, but we urge you to take a safe boating course, and to stay current on navigation and safe boating practices.

About Your Vessel's Documentation

This manual contains the following information:

- glossaries of nautical, wave, and weather terms,
- technical specifications,
- equipment descriptions,
- service information; and,
- supplementary illustrations including the docking plan and electrical and mechanical drawings.

In addition, you will find:

- an envelope containing important warranty information;
- a package containing user's manuals and operating instructions supplied by the manufacturer of each major mechanical, electrical, and comfort equipment component.

Please open the Warranty Materials envelope immediately, fill out the warranty cards and send them in. This will help you get service rapidly and efficiently. Manufacturers *need* your warranty cards!

The user's manuals will help you to get a better understanding of the systems on your Bertram and how they operate. They will also be extremely valuable to the technicians who service your Bertram.

Warnings, Cautions and Notes

Throughout this manual you will find special information in the form of warnings, cautions, and notes. These are intended to alert you to possible dangers to yourself, the crew or passengers, and/or to your vessel. **Read these special information items carefully.**

Just reading a warning or a caution note within a box will not eliminate the danger(s). Pay close attention to these warnings, and exercise "good seamanship." **YOU are the most important factor in preventing accidents.**

Here is the format for the Warnings, Cautions and Notes you will see in this manual:

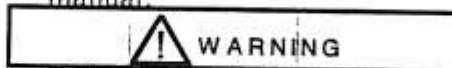

Failure to heed a **WARNING** may result in death or serious injury

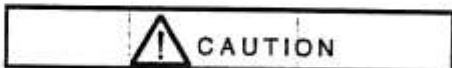

Failure to heed a **CAUTION** may result in injury and/or damage to the vessel.

NOTE:

A note is intended to emphasize important information.

U.S. Coast Guard Regulations

If your Bertram is to be operated in waters regulated by the U.S. Coast Guard, there are certain requirements you must meet. These are discussed in the Coast Guard publication *Federal Requirements for Recreational Boats*.

Some — but not all — of the items you are required to carry are furnished as standard equipment on your vessel.

If you are operating in U.S. territorial inland waters, Coast Guard regulations require that all vessels of 12 meters (39.4 feet) or more in length carry aboard a copy of the USCG publication *Navigation Rules, International — Inland*.

NOTE:

U.S. Coast Guard regulations state that it is the responsibility of the vessel owner to be sure all required equipment is on board and in proper working order.

A Few Words About Maintenance

Some of the on-board systems and equipment require scheduled *preventive* maintenance that may not be covered in this manual. We suggest that you consult the included equipment manufacturer's manual and your dealer for required scheduled maintenance.

Your Bertram dealer is trained to help you, and our factory service representatives are available to assist him if needed.

We wish you many years of pleasurable yachting with your Bertram.

Glossaries

There are three Glossaries included here for your reference.

The first covers terms and definitions peculiar to Yachting.

The second explains terms used to describe Waves.

The third covers terminology used in describing Weather.

These glossaries are not comprehensive. For additional information, we recommend you refer to sources such as Chapman's *Piloting, Seamanship and Small Boat Handling*; DeKerchove's *International Maritime Dictionary*; and the wide variety of U.S. Coast Guard Auxiliary and U.S. Power Squadron publications.

Yachting Terms

Abaft. Closer to the back of the vessel. The transom is said to be abaft the cabin.

Abeam. Alongside; directly off one side of the vessel.

Above. Higher in the vessel. To go up to the next deck in a vessel is to go above.

Adapter. A coupling or device that permits fittings of different sizes to be joined.

Aft. Toward the stern.

After End. The stern.

After Peak. The compartment furthest aft.

Aftermost. Nearest the stern.

Aground. Stuck fast to the bottom.

Ahead. Forward; when the vessel is going ahead, it is moving forward.

Aloft. Above the deck; if you go up a mast or into the rigging, you are going aloft.

Amidship or Admidships. Midway between the bow and stern, or midway between the port side and the starboard side.

Ampere. The standard unit used to measure the strength of an electrical current. Abbreviated "Amp" or "A".

Anchor. A mechanical device used — with an anchor line — to hold a vessel in a desired position.

Anchor Line. The line connecting a vessel to its anchor. It may be all rope, all chain, or rope and a length of chain.

Anchor Rode. See **Anchor Line**.

Anchor Ball. A black, circular, day signal hoisted to show that a vessel is anchored. Replaced at dusk by the anchor light.

Astern. Toward the stern; abaft.

Athwartships. Along a line running perpendicular to the keel.

- Batten.** A strip of wood or metal used to secure tarpaulin(s) in place over a hatch.
- Batten Down.** To secure for rough weather.
- Beam.** 1. The widest distance across a vessel from the outside skin on one side to the outside skin on the other; 2. A transverse structural member that stiffens and supports a portion of the deck.
- Beam Wind.** A wind blowing from the side of the vessel, approximately perpendicular to the longitudinal axis of the vessel.
- Belay.** 1. To make fast or secure, as to belay a line; 2. to cancel or stop an action, as "Belay that last order".
- Below.** Lower in the vessel; to go below is to go to a lower deck or go into the cabin.
- Bend.** A type of knot.
- Bilge.** The lowest interior area of a hull, used to collect water that seeps or leaks in.
- Bilge Pump.** A pump intended to remove spray, rainwater, and the normal accumulation of water due to seepage and spillage; it is not intended for damage control.
- Binnacle.** The stand or support for a magnetic compass.
- Bitter End (of the line).** 1. The last part of a rope or chain; 2. the inboard end of the anchor rode.
- Bollard.** A single post on a dock, pier, or wharf used to secure a vessel's lines.
- Bonding.** 1. Electrically connecting exposed, metallic, non-current-carrying parts to the main engine block; 2. cementing together, as with an adhesive.
- Bow.** The front end of a vessel.
- Bottom.** The portion of the hull below the bilge.
- Break Out.** Take out of storage and prepare for use.
- Bridge.** The main operational control center of a vessel.
- Broach.** To be thrown broadside into the trough of waves out of effective control.
- Bulkhead.** An interior wall or partition.
- Bulwark.** Portion of the hull extending above the deck.
- Camber.** Transverse (athwartships) curvature of the deck.
- Capstan.** A machine, similar to a winch but with a vertical axis, that moves a cylindrical device (called a "gypsy") on a shaft for hauling up an anchor.
- Centerline.** The fore-and-aft line at the middle of the vessel.
- Chain Locker.** See **Rope Locker.** Space or compartment where anchor line is stowed.
- Chine.** The line where the bottom of a vessel meets the side. If this turn is rounded, it is a "soft" chine. If the turn is squared off, it is a "hard" chine.
- Chock.** 1. A fitting or hole in a railing or deck through which a mooring or anchor rode runs; 2. a wedge used to secure something in place.
- Circuit Breaker.** A circuit protection device used to interrupt an electrical circuit when the current flow exceeds a preset level.
- Cleat.** A double ended deck fitting to which lines are secured.
- Coaming.** Raised lip around a hatch, intended to keep water from coming in through the hatchway.
- Cockpit.** An exposed deck area (usually aft) that is substantially lower than the vessel's adjacent weather deck.

- Companionway.** The steps or ladder leading downward from a deck.
- Compartment.** A subdivision of space or room in a vessel.
- Covering Board.** The top surface of the sides and transom on a vessel.
- Cowl.** A bell-shaped air funnel or scoop, projecting above the deck or deckhouse of a vessel, used for ventilation.
- Cradle.** A frame or support for moving a vessel when it is out of the water.
- Dead Ahead.** Directly in front of the vessel is dead ahead.
- Dead Reckoning.** A navigational technique that measures from a last known to the present estimated position based on time, speed, and direction. Abbreviated DR.
- Deck.** The floor in a vessel.
- Dinghy.** A small boat (less than 20 feet) used in moving between ship and shore.
- Dishwater.** Liquid residue from the manual or automatic washing of dishes and cooking utensils.
- Displacement.** The weight of water displaced by the vessel's hull.
- Displacement Hull.** A hull that displaces a volume of water equal to the weight of the vessel at all times. Such a hull is designed to run *in* the water rather than on top of the water as does a planing hull. When a displacement hull moves through the water, it pushes the water out of its way. The water flows around the hull and fills the "hole" the vessel leaves astern.
- Dock.** A pier or wharf to which vessels are moored.
- Documented Yacht.** A vessel of five or more net tons that is owned by a United States citizen, is used exclusively for pleasure, and has valid marine documentation issued by the U.S. Coast Guard. A documented yacht does not show state identification numbers.
- Dog.** A small metal fitting (clamp) used to secure (close) ports, hatches and doors.
- Dog Down.** To tighten the dogs or clamps on a port, hatch, or door.
- Doors.** Access ways through bulkheads are doors. Doors may or may not be watertight.
- Draft.** 1. The depth of a vessel from the actual waterline to the bottom of the vessel's lowest part (e.g., the propeller tip or rudder); 2. the depth of water necessary to float a vessel. Draft may vary with vessel loading and may vary in similar vessels depending on equipment installed.
- Drift.** The speed of a current measured in knots.
- Dunnage.** Cargo associated waste.
- Dye Marker.** A brightly colored chemical that spreads when released in water to attract attention, as to a man overboard.
- Evaporator.** That part of a refrigerating (air conditioning) device where the liquid refrigerant is evaporated to absorb heat and produce cooling.
- Even Keel.** To be floating evenly without listing (leaning) to either side.
- Exhaust System.** The means by which the hot engine or generator exhaust gases are moved from that engine to an outboard terminus and released into the atmosphere.
- Fathom.** Six feet.
- Fender.** A device (usually of rubber or plastic) placed to absorb the impact of contact between vessels or between a vessel and the dock.

- Fiberglass.** Fiber reinforced plastic (FRP).
- Fish.** A zinc plate, lowered overboard, used to reduce corrosion.
- Flare.** 1. The outboard curve of the hull as it comes up the side from the waterline, the reverse of **Tumble Home**; 2. a pyrotechnic device, usually rocket propelled, used for emergency signaling at sea.
- Flat.** A small, partial deck, built to support a piece of equipment or machinery.
- Flemish.** To coil down a line on deck in a flat, circular, concentric arrangement.
- Flotsam.** Floating wreckage or trash.
- Flybridge (flying bridge).** A steering and speed control station located above the main cabin or salon.
- Following Sea.** Waves moving in the same general direction as your vessel.
- Fore-and-Aft.** In line with the longitudinal centerline of a vessel.
- Forefoot.** The forward part of a vessel's keel that curves upward to meet the stem.
- Forward.** Toward the bow.
- Frame.** A built up rib that supports the deck and hull and gives the vessel transverse strength.
- Freeboard.** The height of a vessel's deck above the water line.
- Galley.** The kitchen or food preparation area.
- Galvanic Corrosion.** Corrosion that results from the difference in electrical potential between dissimilar metals immersed in a conductive solution (such as salt water). If the metals touch or are otherwise electrically connected, the difference in potential produces an electron flow between them. This results in gradual destruction of the less-corrosion-resistant metal.
- Garbage.** Kinds of food, cargo and maintenance waste, ashes or clinkers, and domestic waste (trash).
- Gasket.** A strip of sealing material, usually rubber or rubber-like material, set along the edge of a water/gas tight door, port, or hatch.
- Gelcoat.** The thin finish layer of pigmented plastic covering a fiberglass vessel.
- Gland.** The movable part of a stuffing box which, when tightened, compresses the packing.
- Graywater.** Drainage from a dishwasher, shower, laundry, bath, and washbasin.
- Ground (electrical).** The electrical potential of the earth's surface, which is zero.
- Ground Speed.** A vessel's speed over the earth's surface.
- Ground Tackle.** A general term for the anchor, anchor lines, and other fittings used to secure a vessel at anchor.
- Gunwale.** 1. The line where the an upper deck and the hull meet; 2. the upper edge of a vessel's side.
- Halyard.** A light line used to hoist a flag or pennant.
- Hatch.** 1. An opening in the deck or sole that forms an entrance to a compartment (also called a **hatchway**); 2. a cover for a hatch.
- Hardtop.** A permanent cover over the cabin above the main deck; the deck of the fly-bridge.
- Head.** A shipboard toilet or lavatory area which may or may not include a shower.
- Heading.** The direction that a vessel is pointed with reference to true, magnetic, or compass north.

- Headway.** The forward motion of a vessel through the water.
- Heavy Weather.** Stormy weather with high seas and high winds.
- Helm.** The apparatus by which the vessel is steered.
- Helmsman.** Steersman; the one who is at the helm steering the vessel.
- Hitch.** A type of knot.
- Hull.** The body of a vessel including the shell, framing, decks, bulkheads, stanchions, keel, and floors.
- Inboard.** 1. From either side of a vessel to the fore-and-aft centerline; 2. the dock side of a moored vessel.
- Inland Rules.** Nautical "Rules-of-the-Road" that apply in U.S. lakes, rivers, and coastal waters.
- International Rules.** Nautical "Rules-of-the-Road" that apply by international agreement to the high seas.
- Jetsam.** Refuse that sinks when thrown overboard.
- Kedge.** An anchor set out from a grounded vessel, usually astern, to (1) keep her from being driven further aground and (2) assist in refloating her.
- Keel.** The main centerline structural member running fore and aft along the bottom of the vessel; the backbone.
- Knot.** 1. A maritime unit of speed equal to one nautical mile (6,080 feet) per hour, as compared to a statute mile (5,280 feet); 2. a collective term for hitches and bends.
- Ladder.** Steps or stairs.
- Latitude.** Angular distance on the earth's surface north or south of the equator, measured in degrees, minutes, and seconds.
- Lazarette.** Storage compartment cut into the deck at the stern.
- Leadline.** A weighted line used to take depth measurements.
- Lee.** The direction away from that of the wind; the downwind side.
- Leeward.** Away from the wind; downwind.
- Length at Water Line (LWL).** The length of a vessel measured at the water line from bow to stern. This dimension changes depending on how high or low a vessel is riding in the water.
- Length over all (LOA).** A vessel's straight line length from bow to stern. This dimension does not change regardless of how a vessel rides in the water.
- Limber hole.** Drainage hole for bilge water along the keel and stringers.
- List.** Incline to port or starboard.
- Longitude.** Angular distance on the earth's surface east or west of a reference line (the prime meridian) passing through Greenwich, England. Longitude is measured in degrees, minutes, and seconds.
- Longitudinal.** Lengthwise; running along the length of the vessel.
- Lubber Line.** A mark or line on the compass parallel to the keel and indicating forward.
- Mast.** A pole or tube used to support lights, radar devices, flags, etc.
- Main Deck.** The principal and highest deck of the hull.
- Midship.** 1. Aligned with the longitudinal axis of the vessel, as "Rudder is midship."; 2. at the center of the vessel.
- Moor.** To anchor or secure a vessel with chain(s) or line(s) to shore, a dock, a buoy, etc.

Mooring Bitt. Standards, placed in pairs, to which mooring lines are made fast.

Mooring Line. The line with which a vessel is secured to a mooring place.

Navigation Lights. A set of red, green, and/or white lights which must be shown by all vessels between dusk and dawn to show course, size, and position. They are required unless moored or at anchor in a recognized anchorage.

Overhead. A vessel's ceiling or roof.

Outboard. 1. From the fore-and-aft centerline of a vessel toward either side; 2. the seaward side of a moored vessel.

Overboard. Over the side of a vessel, usually into the water.

Passageway. A corridor or hallway.

Pilaster. A rectangular structural support column which is an extension of the port and starboard aft cabin sides and which supports the hardtop and the flybridge.

Pitch. 1. The vertical (up and down) motion of a vessel's bow in a seaway, about the athwartships axis; 2. the axial advance of a propeller during one complete revolution.

Pitchpoling. Tipping end over end after striking an obstruction or running down a wave and burying the bow; somersaulting.

Planing Hull. A hull designed to ride on top of the water at cruise. At slow speeds, a planing hull will displace water the same as a displacement hull. At higher speeds, a planing hull lifts up onto the water's surface, as a hydroplane, shortening the water line length and reducing drag.

Port. The left side of a vessel (looking forward).

Port Beam. The left center of a vessel.

Port Bow. The forward left area of the vessel.

Port Quarter. The left rear area of the vessel.

Pounding. The action of waves as they repeatedly raise a grounded vessel and drop it against the seabed, a reef, etc.

Propeller. The screw-like revolving device that drives the vessel through the water.

Propeller Action. The force exerted by the propeller. The force causes displacement of water and pushes the vessel ahead. A propeller creates a suction screw current and a discharge screw current.

Pulpit. An extension on the bow, originally used to support a harpooner; in pleasure vessels, used primarily to ease anchoring.

Riser. A two elbow angular pipe connected to the engine's turbo outlet to prevent water from the exhaust entering the engine.

Rope Locker. Space or compartment where the anchor line is stowed.

Rudder. A movable, vertical fin extending into the water at the stern of a vessel, used for steering.

Salon (Saloon). The main social cabin on a vessel, usually the largest area, sometimes called the deckhouse.

Scupper. A drain from the edge of a deck, discharging overboard.

Seacock. A positive action shut-off valve connected directly to the hull seawater intake and discharge piping.

Secure. To fasten down.

Shaft. The cylindrical member that connects the engine/transmission to the propeller.

Shaft Log. A reinforcing structural member at the hull bottom where the propeller shaft penetrates the hull.

- Sheer.** The top of the hull's curvature at the deck line.
- Sheer Strake.** The upper edge of the hull, just below the deck.
- Shoal.** An area of shallow water.
- Silencer.** A specially designed baffled chamber installed in an exhaust system to reduce noise; a muffler.
- Sole.** Small boat term for deck, as in "cabin sole".
- Stanchion.** A vertical structural support member between decks.
- Starboard.** The right side of a vessel (looking forward).
- Starboard Beam.** The right-center of a vessel.
- Starboard Bow.** The front right area of a vessel.
- Starboard Quarter.** The right rear area of a vessel.
- Steerageway.** The lowest speed at which a vessel can steer.
- Stem.** The extreme leading edge of a vessel's hull.
- Stern.** The back of a vessel is the stern.
- Strainer.** A coarse filter used to keep objects out of an intake port (such as the cooling water intake).
- Stringer.** A fore and aft continuous member used to give a vessel longitudinal strength.
- Strut.** A propeller shaft support that hangs below the hull.
- Stuffing box.** Device to prevent leakage around a moving part (such as a propeller shaft or a rudder shaft) that passes through a hole in the vessel; it contains stuffing material and a packing gland.
- Sump.** A pit or well into which water drains (i.e., the shower sump or engine room sump).
- Sump Pump.** A pump intended to remove the water collected in a sump.
- Superstructure.** Structures extending above the weather deck.
- Tide.** The alternate rise and fall of the surface of oceans, seas, and the bays, river, etc. connected with them, caused by the attraction of the moon and sun. The tide occurs twice in each 24 hours and 51 minutes (lunar day). During its rise, tide is called *flood tide*, and during its fall, *ebb tide*.
- Topside.** Above decks. To go up to the top deck in a vessel is to go topside.
- Toxic.** Poisonous (as carbon monoxide).
- Transom.** A wide, flattened, or slightly curved stern.
- Transverse.** Across the vessel; athwartships.
- Trim.** A term used to describe the way a vessel rides in the water. A change in trim is defined as a change in the difference between the forward and aft drafts. If a vessel is trimmed with the stern lower, it is "trimmed by the stern".
- Tumble Home.** The shape of the hull as it moves outboard going down from the gunwale to the waterline; the opposite of flare.
- Watch.** A duty period at sea, normally 4 hours. Here are a day's watches:
First watch 2000 - 2400 (8 pm - midnight)
Midwatch 0000 - 0400 (midnight - 4 am)
Morning watch 0400 - 0800 (4 - 8 am)
Forenoon watch 0800 - 1200 (8 am - noon)
Afternoon watch 1200 - 1600 (noon - 4 pm)
First dogwatch 1600 - 1800 (4 - 6 pm)
Second dogwatch 1800 - 2000 (6 - 8 pm)

Water Line. The line of the water's surface on the hull when the vessel is afloat.

Water Line Length. See **Length at Water Line.**

Water Tight. Sealed to prevent passage of water.

Weather Deck. A deck with no overhead protection.

Web Frame. A frame with a deep web, usually a main strength member.

Wet Exhaust. An exhaust system where cooling seawater is mixed with exhaust gases just after the riser and this mixture is ejected from ports at the stern.

Windlass. Machine used to hoist the anchor(s).

Wave Terms

- Adiabatic.** A change of volume or pressure without gain or loss of heat.
- Breaker.** A single breaking, plunging or spilling wave.
- Breaker Line.** The outer limit of the surf. Note that breakers may not all be in a line. They can occur outside the breaker line and seem to come from nowhere.
- Comber.** A wave on the point of breaking. A comber has a thin line of white water on its crest, known as "feathering".
- Crest.** The top of a wave breaker or swell.
- Fetch.** The unobstructed distance that the wind can blow over the water to make waves.
- Foam Crest.** The top of the foaming water that speeds toward the beach after a wave has broken, popularly known as "white water".
- Following Sea.** Waves moving in the same general direction as your vessel.
- Frequency.** The number of crests passing a fixed point in a given time.
- Period.** The time it takes for two successive crests to pass a fixed point.
- Series.** A group of waves which seem to travel together and at about the same speed.
- Surf.** A number of breakers in a continuous line.
- Surf Zone.** The area near shore where breaking occurs continuously in varying intensities.
- Trough.** The valley between waves.
- Waves.** Periodic disturbances of the sea's surface, caused by wind, seaquakes, and the gravitational pull of the moon and the sun.
- Wave Gradient.** A wave's slope or angle from trough to crest.
- Wave Height.** The distance from the bottom of a wave's trough to the top of its crest.
- Wave Length.** The distance from one wave crest to the next in the same series of waves.

Weather Terms

Air Mass. A region of the lower atmosphere in which air is similar in pressure, temperature, and humidity. Although its shape may change from day to day, an air mass generally moves across the continent like an invisible ice floe.

Air Pressure. A measure of the force exerted by the atmosphere above. Pressure differences between air masses cause winds that move from a high pressure area to a low pressure area.

Internationally, air pressure is measured in millibars, but many barometers in use are calibrated in the old standard, inches of mercury (in. Hg). Inches of mercury can be converted to millibars by multiplying the reading by 33.86.

Sea level standard air pressure is 1013.2 millibars (29.92 in. Hg) at 70°F. Barometers have read as high as 1050 millibars (31 in. Hg), and the eye of a hurricane has produced readings well below 930 millibars (27.47 in. Hg).

Front. The line along which opposing warm and cold air masses meet, generally producing a band of wet, stormy weather. Four types of fronts are associated with weather forecasting:

Cold Front. A front produced when a cold, high-pressure mass overtakes a warm, low-pressure area. The denser cold air wedges under the warm air, creating clouds and rain. If the low is already unstable and turbulent, there may be rapid development of heavy thundershowers accompanied by high, gusty winds. Behind the front, temperatures drop and skies are clear.

Warm Front. A front produced when a warm low pressure air mass meets and rides up and over a colder high pressure mass. As with a cold front, clouds and rain will ap-

pear, but in a warm front they will appear with less violence.

Stationary Front. A front produced when neither the high or the low is moving much. This type of front will produce some clouds and rain.

Occluded Front. This is the condition where two fronts collide. Usually the cold front overtakes a slower moving warm front, causing a complex weather system that lifts the warm front and produces heavy clouds and rain.

High. A center of pressure surrounded by lower pressure, caused by a mass of cooler, sinking, drier air. This raises ground level air pressure, producing clear skies and good weather.

Summer highs can produce sustained hot weather. Winter highs mean cold weather, since there are no night clouds to trap the heat.

Some highs become semi-permanent weather features during particular times of the year and have recognizable names.

Isobar. Weather map line that connects all local points of equal air pressure. Isobars are usually closed lines, and they generally define high or low pressure air masses. Winds tend to:

- 1) blow parallel to the isobars;
- 2) flow between masses of different pressures;

NOTE:

On the weather map, the greater the pressure difference, the closer the isobars and the stronger the winds.

- 3) move outward from the center in high pressure air masses and clockwise (in the North American continental area);

4) move in toward the center in low pressure areas and counter-clockwise (in the North American continental area).

Isotherm. A line on a weather map similar to an isobar except that an isotherm connects points of equal temperature.

Low. The absence of an air mass and the warmer, moist, rising air generally means clouds, precipitation, and stormy weather.

Hurricanes are examples of extremely concentrated low pressure systems.

Ridge. An elongated high pressure finger extending out from a high.

Trough. An elongated low-pressure area extending out from a low. A trough usually means unsettled weather.

3. Technical Data

3.1 Vessel Specifications

MODEL 50S CONVERTIBLE

BOAT NAME

OWNER'S NAME

OWNER'S ADDRESS

HAILING PORT

Hull Number

Door Key Number

Registration Number

Length Overall =50 feet, 0 inches

Beam =16 feet, 2 inches

Draft =5 feet, 0 inches

Fuel Label Capacity =1010 U.S. Gallons

Water Capacity =150 U.S. Gallons

Cruise Weight =60,000 pounds (approx)

3.2 Main Engines and Transmissions

Engine Manufacturer =

Gear Manu. =

Engine Model =

Gear Model =

Gear Ratio =

Gear Oil Filter
Element Number =

Fuel Filter (Primary) =
Filter Element =

Fuel Filter(Secondary) & Element =

Lube Oil Filter & Element =

Air Filter Element =

PORT ENGINE

STARBOARD ENGINE

Serial Number =

Serial Number =

Gear Serial Number =

Gear Serial Number =

3.3 Engine Batteries

Manufacturer =Douglas Battery

Model Number = 8D—3

Voltage =12 Volts

C.C.A. = 1400

Bertram Part Number =142250

RES. CAP. =435 Min.

System Voltage =24vdc

3.4 Propellers

Manufacturer: Federal (Michigan);

Style =

Diameter =

Material =Nibral;

Port Rotation =Left Hand

Starboard Rotation =Right Hand

3.5 Propeller Shafts & Couplings

Shaft Material: Stainless steel

Shaft Diameter =

Shaft Length =

Shaft, Bertram Part Number =

Coupling, Bertram Part Number =

NOTE:

The propeller specifications are correct for the boat as it is delivered from the Bertram Yacht factory in Miami, FL.. Changes made to the boat's configuration (Adding a tuna tower, davits, a dingy, etc.) may alter engine loading and require different propeller specifications. A test run should be made to verify correct engine performance.

3.6 Diesel Generator

	U.S.A.	INTERNATIONAL
Manufacturer =	Northern Lights	Northern Lights
Model =	M844.3	M844.7
Serial Nr.	_____	_____
Capacity (KW) =	16.0	12.0
Voltage (a.c.) =	120/240	220
Phase =	Single	Single
Frequency (Hz) =	60	50
Fuel Filter (Primary Element) Number =		
Fuel Filter (Secondary Element) Number =		
Lube oil Filter =		

NOTE:

The generator d.c. cranking circuit is connected to the stbd battery bank.

3.7 Fuel Remaining In Tanks

The Table below shows the relationship between the fluid level indicated on the fuel gauges and the approximate number of gallons of fuel remaining in that tank.

FUEL GAUGE READINGS Vs TANK GALLONAGE		
<i>Gauge Reading</i>	<i>Fwd Tank</i>	<i>Aft Tank</i>
FULL	510 gallons	500 gallons
3/4	340 gallons	415 gallons
1/2	174 gallons	205 gallons
1/4	87 gallons	38 gallons
EMPTY	0 gallons	0 gallons

NOTE: Usable fuel is considered to be 90% of fuel tank label capacity.

3.8 Ventilation And Exhaust Blowers

HEAD EXHAUST BLOWERS =150 cubic feet per minute (CFM), 24-Volts d.c. (one in each head).

ENGINE-COMPARTMENT =Two (2) 250 CFM, 120-Volt a.c./220-Volt a.c. Euro, thermostatically controlled (ON at 110°F and OFF at 90°F) with manual override switch.

3.9 Bilge And Sump Pumps

Bilge Pumps =1,750 Gallons per Hour
 Engine Room Sump Pump =4.0 GPM
 Gray Water Sump Pump =4.0 GPM

4. Equipment Location

4.0.1 General

The following general list of equipment can be used as a quick location reference. The list may not be complete for your particular boat and spaces are provided for you to make additions.

You should check and write down the location of each piece of equipment on this list plus the ones that you may have added. Some of the items may not apply to your boat since the list includes boats of all sizes.

Example:

Pumps & Pump Floats

Fwd bilge Under the fwd companionway hatch at the master stateroom door.

4.0.2 Fuel System

Fuel Tank

Aft fuel tank _____

Fwd fuel tank _____

Aux. fuel tank _____

Fuel Tank Engines Selector Valves

Port engine _____

Stbd engine _____

Fuel Line Shut Off Valves

Diesel

Aft fuel tank _____

Fwd fuel tank _____

Aux. fuel tank _____

Port Eng. primary filter _____

Stbd Eng. primary filter _____

A.C. Generator(s)

Single Gen or(port) _____

Gen (stbd) _____

Gas

Port engine fuel line _____
 Stbd engine fuel line _____
 A.C. generator _____

Fuel Filter(s)

Diesel

Port engine _____
 Stbd engine _____
 Single Gen or(port) _____
 Gen(stbd) _____

Gas

Port engine _____
 Stbd engine _____
 Generator _____

Fuel Liquid Level Gauge(s)

Port fuel tank _____
 Stbd fuel tank _____
 Aux. fuel tank _____

4.0.3 Fresh Water System

Water tank(s) _____
 Shut Off Valve _____
 Liquid level gauge _____
 Water Pump _____
 Circuit breaker _____
 Dockside water connection. _____
 Main engine & a.c. generator water fill hose _____
 Icemaker supply line filter & water valve _____
 Clothes washer hot & cold water valves _____
 Other _____

4.0.4 Shower Sump System

Shower sump tank(gray water) & strainer _____
 Pump _____
 Pump float _____
 Pump circuit breaker _____
 Other _____

4.0.5 Bilge Pump System

Pumps & Pump Floats

Fwd bilge _____
Midship(e/r) bilge _____
Aft bilge _____
Engine room sump pump & strainer _____

Switches _____
Fwd bilge _____
Midship(e/r) bilge _____
Aft bilge _____
Engine room sump pump _____

4.0.6 Blowers

Engine room
Port _____
stbd _____
Auto/Man switch _____

Heads
#1 _____
#2 _____
#3 _____

Fuses
Engine room
Port _____
stbd _____

Heads
#1 _____
#2 _____
#3 _____

Other _____

4.0.7 Air Conditioning System

Condensing units (compressors)

Salon _____
Port stateroom _____
Stbd stateroom _____
Fwd stateroom _____
Other _____

System controls

Salon _____
Port stateroom _____
Stbd stateroom _____
Fwd stateroom _____
Other _____

Seawater pump(s)

relay box & fuse _____
Pump #1 _____
 Water intake _____
 Strainer _____
 Seacock _____

Other _____

Circuit breakers

Salon _____
Port stateroom _____
Stbd stateroom _____
Fwd stateroom _____
Other _____

4.0.8 Monitor Systems (except fire extinguishing))

Note: Some of the monitors may combine bilge flood, overheat detection, gray water tank, and black water(holding) tank functions. Be aware that one fuse may disable multiple functions. The engines monitor system(s) monitor only the engines and they are not part of any other monitor operation. The monitor control boxes with metal enclosures have fuses on the circuit control board as well as a circuit breaker or fuse on the electrical panel.

Monitors

Engines _____

 Port _____

 Stbd _____

 Fuses _____

 Panel _____

 Control board _____

Other _____

Overheat, engine room _____

 Fuses _____

 Panel _____

 Control board _____

Other _____

Gray water tank _____

 Fuses _____

 Panel _____

 Control board _____

Other _____

Black water (holding) tank _____

 Fuses _____

 Panel _____

 Control board _____

Other _____

Bilge flood _____

 Fuses _____

 Panel _____

 Control board _____

Other _____

 Fwd bilge sensor _____

 midship bilge sensor _____

 aft bilge sensor _____

Other _____

4.0.9 Fire System

The system includes the fixed extinguisher bottle, manual discharge "T" handle, control head, and auto shutdown box. Portable fire extinguisher bottles are also listed below.

- Fixed system extinguisher bottle _____
- Manual "T" handle _____
- Control head with lights & horn _____
- Auto shutdown control box(black) _____
- Portable fire extinguisher bottle #1 _____
- Portable fire extinguisher bottle #2 _____
- Portable fire extinguisher bottle #3 _____
- Portable fire extinguisher bottle #4 _____
- Portable fire extinguisher bottle #5 _____
- Other _____

4.0.10 Toilet System

- Holding tank _____
- Holding tank pump _____
- pump switch _____
- Toilet pump, intake & discharge.
- Pump #1 _____
- "Y" valve _____
- Strainer(If provided) _____
- Intake seacock _____
- Discharge seacock _____
- Pump #2 _____
- "Y" valve _____
- Strainer(If provided) _____
- Intake seacock _____
- Discharge seacock _____
- Pump #3 _____
- "Y" valve _____
- Strainer(If provided) _____
- Intake seacock _____
- Discharge seacock _____
- Other _____

4.0.11 Seawater pump system

Pump _____
 Intake seacock _____
 Strainer _____
 Baitwell control valve , supply & drain _____
 Other _____

4.0.12 Cablemaster

Motor assembly & fuse _____
 Cable bucket _____
 Other _____

4.0.13 Trim tabs

Pump _____
 Reservoir _____
 Other _____

4.0.14 Batteries

Port _____
 Stbd _____
 Other _____

4.0.15 Engines & A.C. Generator(s)

Port engine seawater seacock _____
 Port engine seawater strainer _____
 Stbd engine seawater seacock _____
 Stbd engine seawater strainer _____
 Single or (port) generator seawater seacock _____
 Stbd generator seawater seacock _____
 Other _____

4.0.16 Lube Oil Transfer System

Pump _____
 Switch _____
 Valve(s) _____

5. Carbon Monoxide (co) Gas

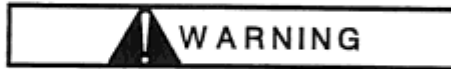

Gasoline and diesel internal combustion engines use petrofuels and emit carbon monoxide gas, which is colorless, odorless, and lethal if breathed in sufficient quantities.

When at anchor, be sure to open windows, hatches, and vents to maintain fresh air even with the air conditioner operating and when operating the ac generator.

When tied up to a dock and/or immediately alongside other vessels or when rafted up against one or more other vessels, pay particular attention to the main engine and generator exhaust emissions from the nearby vessels; since a lethal concentration of carbon monoxide could be drawn into your vessel from the outside by your ventilation system.

Remember that carbon monoxide (CO) poisoning is one of recreational boatings most insidious hazards. CO poisoning first attacks the brain's judgment center and its first symptoms (headache and nausea), are easily confused with seasickness. CO is lethal and its effects are cumulative. As CO builds up in your body, your blood can carry less and less oxygen. This can take place over a long period of time and at relatively low concentrations.

Carbon Monoxide gas is colorless, tasteless, and odorless. Therefore, take no chances with your life and health. If you even think that you smell excessive exhaust odor, or if you think that you or anyone on your vessel might possibly have one or more of the following classic symptoms of carbon monoxide poisoning which can be easily masked by the symptoms of common sea sickness:

- throbbing in the temples;
- dizziness
- ringing in the ears;
- watering and itching eyes;
- headache;
- nausea; and/or,
- cherry pink or red skin color.

YOU SHOULD IMMEDIATELY:

- Move everyone on board out on deck in the fresh air;
- open all hatches, windows, and vents to air out your vessel;
- shut down the engines and/or the a.c. generator until you have located the source of the carbon monoxide;
- If it comes from your vessel, make all the necessary corrections and/or repairs before getting underway again; and,
- you should also be aware, that it is quite possible for you to get the exhaust fumes of vessels tied up along side of your vessel or even docked in the next slip. If it comes from a nearby vessel, move your boat or leave it.

6. Fire Monitor And Extinguishing Systems

6.1 General

NOTE:

Some models do not have duplicate readouts of systems because of the boats configuration.

Boating safety studies show that the best way to fight shipboard fires is to prevent them. Most shipboard fires ARE preventable by the obvious steps of:

- not allowing fuel spillage to accumulate in the bilge;
- properly storing paint and other combustibles;
- taking appropriate care when cooking, especially frying;
- taking appropriate care with smoking materials; and,
- not exceeding the safety factor built into electric wiring.

Unfortunately, on-board fires do occur. Boating safety statistics * show that unless the fire is put out in the first 5 to 10 minutes, 80 % of all pleasure craft that catch on fire are destroyed.

To give you fire warning and fire fighting capabilities, the following equipment is furnished as a part of your Bertram:

- Engine Room Fire Monitor(Overheat Detection) System.
- Engine Room Fixed Fire Extinguisher System with Fire Extinguisher Discharge Monitor.
- Portable Fire Extinguishers.

* DOT U.S.C.G. COMDTINST M16754.1G "BOATING STATISTICS"
JUNE 1986

6.2 Engine Room Fire Monitor (Overheat Detection) System

The fire monitor system monitors your vessel for fire(overheat) in the engine room (compartment).

NOTES:

The fire monitor system is separate from the onboard fixed fire extinguisher system discussed later.

The fire monitor will not detect an overheat condition outside of the engine room.

The combination fire monitor/bilge flood monitor is tested and silenced by the same switches and controlled by the same power fuses. It can be totally disabled by removing the fuse in the "DC Main Supply" panel or inside the monitor control box.

On the flybridge engine control station, is a red indicator marked "**engine room overheat**". There is a duplicate indicator on the "DC Salon Distribution" panel. The lamps are connected, through a monitor control unit, to overheat detectors mounted on the engine room overhead.

The overheat detector is thermal disc that is sensitive only to a fixed high temperature setting. The system will activate any time that the engine room temperature exceeds the thermal disc temperature; whether or not, there is a fire.

Operation.

If an overheat condition occurs, the red indicator will light and the horn will sound indicating an overheat problem in the engine room. At that time, check the engine room for a problem.

The monitor horn can be silenced by momentarily pushing the monitor "**silence**" button on the flybridge control panel, or the button on the dc salon panel. The light will remain lit until the heat detector(s) reset themselves.

The monitor system can be checked at any time by pressing the monitor "**test**" button on the flybridge control panel. With the button pressed, the "**overheat detector**" and "**bilge flood**" lights will light and the monitor horn will sound. Releasing the "**test**" button will cause the lights to go dark and the horn to stop sounding. An open circuit in the heat detector wiring will also cause the monitor to respond as if there is an overheated condition.

6.3 Engine Room Fixed Fire Extinguisher System.

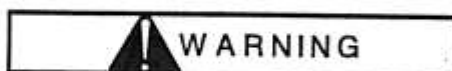

Toxic by-products are produced when agent FE-241 extinguishes fire. Avoid breathing the fumes, smoke from fire, or engine exhaust.

Inhalation of FE-241 in high concentrations may cause death without warning. Read the manual provided with the fire extinguisher system for complete information.

Most fire fighting agents stop engines by oxygen depletion, agent FE-241 may not stop a diesel engine. If you do not quickly stop your diesels, the agent concentration will be rapidly lowered and may be eliminated as an effective fire fighter.

NOTE:

To give FE-241 the chance to put out a fire, the concentration must be kept as high as possible. This means keeping all hatches to the engine room(compartment) closed at all times.

Your fixed fire extinguishers fight engine room fires. Fires outside this compartment are fought with hand held extinguishers.

This system uses agent FE-241(Chlorotetrafluoroethane). Its use is confined to a normally unoccupied area, such as an engine room. Inhalation of high concentrations of this agent can cause death without warning. Vapor reduces oxygen available for breathing and is heavier than air. Read the manual provided with the system for complete information.

Your Bertram has an automatic/manual fixed fire extinguisher system that protects the engine room. The fixed fire extinguisher system consists of a FE-241 agent gas bottle with its controls and indicators. The bottle is in the engine room and discharges into the engine room. The control head with the "engine shutdown" override switch, discharge light and horn is located on the flybridge console. The manual discharge "T" handle and a second discharge light are located in the cockpit. Become aware of the location of each of these items and how they operate. Read the fire extinguisher manual for complete instructions about operation.

6.3.1 System Operation

The first indication of an over-temperature condition will usually be the fire monitor horn and light, which signals the detection of an over-temperature condition in the engine room. When the temperature rises rapidly due to a fire, there may be only a brief time span between the monitor indication and the discharge of fixed fire system.

When discharged automatically or manually, the system:

- shuts down the forced air ventilation (blowers) system;
- shuts down the main engines;
- shuts down the a.c. generator(s);
- releases FE-241 gas into the engine room; and,
- sounds the FE-241 system discharged monitor horn.

If there is an engine room fire, do not wait for the system to discharge automatically. Discharge the system manually from the cockpit. The system is manually discharged from the cockpit by pulling the fire system "T" handle pin and then pulling the handle.

Read the fire extinguisher manual for complete instructions about operation.

NOTES:

Depending on the rate of temperature rise, the time between the Fire Monitor System alarm and the FE-241 fixed system alarm may be too short to be acted upon as separate events.

Automatic discharge of the bottle can not be defeated. It will always discharge at its designed discharge temperature.

6.3.2 After Discharge of the Fire System



Do not open the engine room hatch or try to enter the engine room for at least 15 minutes after fire agent has discharged. To allow oxygen to enter a compartment before hot metals and/or fuels are cool may cause reignition or flash back.

Except in the rare case of a coincidental emergency requiring immediate power to maneuver your vessel out of danger from another source, you must give the FE-241 agent sufficient time to completely extinguish the fire.

Therefore, once the agent is discharged, to minimize the risk of reignition or flashback, you should wait a minimum of fifteen minutes for any heated metal or fuel to cool off before opening the engine room.

If you hear the **Extinguisher Discharged** horn, the Fire System has discharged (check the discharged light). Take these steps immediately.

- Unless other dangers make maneuvering power necessary, immediately shut down the engines if the automatic system has not already done so.
- Shut down all electrical power except for the bilge pumps, navigation lights (if after dark), and the emergency radio.
- Extinguish all open flames, smoking material, etc.
- Do not open the engine room hatches for at least 15 minutes. Then carefully check to be sure that the fire is totally out. Verify by feeling around the hatches and bulkheads to ensure these surfaces are cool before opening the hatches.
- Stand by with portable fire extinguishers in case the fire spreads past the engine room.

6.3.3 Inspection and Restarting Boat Systems

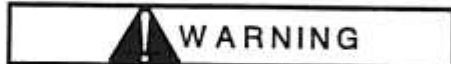

The combustion by-products of FE-241 are toxic. Wait for blower and natural ventilation to completely change engine room air before entering.

After determining the fire is out:

- Silence the Fire Monitor(Overheat Detection) System by momentarily depressing the silence switch on the flybridge control console or on the salon 24Vdc panel. The light will remain lit until the heat detector(s) reset themselves.
- Use the FE-241 FIRE SYSTEM "**Manual Override**" switch to allow switching on the blowers, a.c. generator(s) and main engines;
- Ventilate the engine room to remove any burned FE-241, which is *toxic*;
- Have the proper type of United States Coast Guard-approved hand-held fire extinguisher ready when you cautiously open the hatches;
- Carefully examine the engine room for damage and determine the cause of the fire;
- Make the necessary emergency repairs;
- Start your engines;
- Turn on only those electrical circuits necessary to safely maneuver your vessel.
- Return to port;
- Have the fixed fire extinguisher system and any hand-held fire extinguishers that were used, checked and serviced as soon as possible.

6.3.4 Fixed Fire Ext. Maintenance

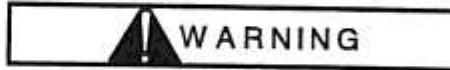

Never attempt to disassemble any part or portion of your fixed fire extinguisher system. This system contains liquefied gas at high pressure and serious injury could result.

Read the fire extinguisher system manual supplied with the system for accurate information concerning maintenance.

6.3.5 Using the Portable Fire Extinguishers



Do not use water based extinguishing agents on electrical fires due to the potential danger of electric shock to the fire fighter and the possibility of short circuiting the electrical circuits and causing more fires.

For fires other than engine room (compartment) fires, Bertram supplies mounted, type B 1, dry chemical, portable (hand held), fire extinguishers, U.S.C.G. approved Type BC-1.

NOTE:

If you hold the trigger on a hand-held fire extinguisher, it will be empty in 8 to 20 seconds, and some fires can reignite. Use only the amount of chemical necessary to suppress the fire—don't waste the resource you may need soon.

6.3.6 Portable Fire Ext. Maintenance

The portable (hand held) fire extinguishers should be examined monthly for at least the following:

- That they are properly secured in their intended mounts;
- that they have not suffered rust, corrosion, or mechanical damage;
- that they are fully charged. Extinguishers that have pressure gauges or indicators should show that the pressure is within the prescribed limits; for fire extinguishers without pressure gauges or indicators, for those that use Halon, and for the CO₂ portable fire extinguishers, the proper procedure is that each fire extinguisher be periodically weighed and the exact weight be noted on the tag attached to the extinguisher);
- that the tamper proof seal proves that the extinguisher has not been operated; and,
- that the nozzle orifice is unobstructed and the extinguisher hose is in good condition.

Portable Fire Extinguisher Service. Have a firm specializing in fire extinguisher maintenance make an annual full check on all portable fire extinguishers as per the maintenance instructions on the extinguisher's nameplate. This firm should attach a tag to the extinguisher showing the date of each maintenance check.

After Using a Fire Extinguisher. After any use, portable fire extinguishers must be recharged by a qualified fire extinguishing service facility or the extinguisher should be replaced with a comparable unit.

6.3.7 Classes of Fires.

For the purposes of selecting the correct fire fighting tool, fires are divided into the following three classes:

Class "A" Fires. Class "A" fires are fueled by paper, wood, fabric, rubber, and some plastics. Water is the best means of extinguishing a Class "A" fire and should be used as soon as possible. Drench the fire, open the material to expose all burning embers and redrench, or throw the smoldering material overboard.

Class "B" Fires. Class "B" fires are fueled by flammable liquids (i.e., gasoline, oils, paint, and cooking fats). Carbon dioxide, dry chemical, and Halon fire extinguishers are suitable against Class "B" fires. A firefighter should aim his extinguisher at the base of the fire, not at the smoke, working in a horizontal sweeping motion from the front to the back of the fire.

Class "C" Fires. Class "C" fires are caused by energized electrical equipment. Carbon dioxide, dry chemical, and Halon fire extinguishers will extinguish Class "C" fires. Class "C" fires should **NEVER**, repeat **NEVER** be fought with water which could cause short circuits and more fires and/or endanger the life of the fire fighter by electrocution.

Galley grease fires may be fought with the dry chemical extinguishers, by smothering the fire (covering with a pot lid), or with baking soda; but **NEVER**, repeat **NEVER** with water which splatters hot grease, possibly spreading the fire and causing injuries

6.4 The Fire Fighting Plan

After an active fire prevention program, a well thought out and well rehearsed vessel fire fighting plan is probably the next single most important step toward organizing the fire fighting efforts of the vessel operator, the crew members, and guests. Such organization can literally be vital since studies of fires at sea show that a quick reaction time is absolutely essential to extinguishing a shipboard fire. Therefore, the vessel operator as well as other designated persons on board should be thoroughly familiar with:

- The location of the controls for and the operation of the fixed fire extinguishing system.
- the location of the switches to shut down:
 - the engines,
 - the a.c. generator(s),
 - the d.c. power supply,
 - the forced air ventilation blower system; and,
- the location of, and instructions on the operation of, every hand held portable fire extinguisher on board as well as what type of fire(s) it should or should not be used on.

6.5 Fire Or Emergency Evacuation Plan

One problem that can and should be prepared for is an uncontrollable fire or other emergency at sea requiring that all hands leave your vessel. As an important part of your fire emergency preparedness plan, the operator, along with the crew and regular guests should develop and practice an emergency evacuation plan (Abandon Ship Drill). As a minimum, this plan should include:

- The location of the PFDs (life vests) and how to don them;
- the location and operation of any other emergency flotation equipment such as a life raft;
- the speedy operation of the forward hatch;

How to quickly summon help by:

- Using the hailing/emergency channel for the on board VHF (in inland or coastal waters) or the single side band radio (past the continental limits);
- when and how to use flares and/or daylight visual distress signals;
- the use of the orange and black distress flag; and,
- the Emergency Position Indicating Radio Beacon (EPIRB).

7. Engine Control Stations & Maneuvering

7.1 General

This chapter covers a basic over-all and functional description of your Bertram's engine controls and their operation.

7.2 Control Stations

7.2.1 General

Your Bertram's underway maneuvering controls and, with a few exceptions, all of your Bertram's functions are managed from the flybridge(main helm) station. The following exceptions are managed from the cabin, the cockpit, the engine-compartment, and/or the staterooms,

- some of the main electrical distribution functions;
- the entertainment center functions;
- the galley appliances;
- the a/c climate control functions; and,
- manual discharge of the fixed fire extinguishing system.

7.2.2 Flybridge(MainHelm) Navigation and Engine Control Station

This is your vessel's main navigation and engine control station.

NOTE:

If your instrument and switch panel is protected by an acrylic cover, do not discard.

The switches are weatherproof but not waterproof, and electrical damage may result if water gets behind the cover.

The main navigation and engine control console is equipped with the following:

- the engine, transmission, and steering controls;
- the engine performance instruments;
- the engine and accessory switches;
- the monitor system indicators; and,
- the optional features you have ordered.

7.2.3 Cockpit Engine Control Station (Custom)

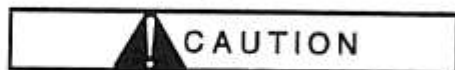

The cockpit engine control station has little or no forward visibility and no steering capability.

Use this station only when:
a lookout is on the bridge;
the vessel is in safe, open waters;
you need limited maneuvering with engines only to aid in boating a large fish.

This engine control station should be used only under the following conditions:

- a qualified lookout must be on duty on the flybridge. This lookout must be prepared to take over control of the vessel if necessary;
- the vessel must be operating in open seas well clear of obstructions or dangers;
- maneuvering must be restricted to limited, low speed maneuvers performed to assist in the boarding of a large fish.

The cockpit engine control station is-as its name implies-a station for engine control only. It is not intended for use in navigating your vessel.

7.3 Speed And Maneuvering Controls

7.3.1 General

Located on the main control station are all of the controls necessary to operate your Bertram's engines and maneuvering functions. These controls include:

- the twin throttles;
- the twin FORWARD/NEUTRAL/REVERSE transmission controls
- the steering system;and,
- the trim tab system controls.

See "Systems & Accessories" chapter for steering and trim tab systems operation.

7.3.2 Throttle Controls



To avoid transmission damage while maneuvering, do not shift until engine speeds have dropped to idle.

NOTE:

If your Bertram has Detroit Diesel Electronic Controls (DDEC), please refer to the DDEC manual for proper operation.

The main engine throttle controls for your Bertram are twin levers with red knobs on the main control console, starboard of the helm. Each lever controls one engine's speed and connects directly to that engine's governor mechanism by a push-pull cable. Push the levers forward to increase engine speed and pull back to reduce speed. The farthest aft position is the "IDLE" position.

7.3.3 Forward/Neutral/Reverse Transmission Controls

The twin clutch control levers, port of the helm, have black knobs and a detent to let you "feel" the "NEUTRAL" position. Pushing a lever forward of neutral puts that transmission(s) in forward. Conversely, pulling a lever back past neutral puts that transmission in reverse.

It is vital that you always throttle back your engines, let them slow to an idle (less than 1,000 Revolutions Per Minute [rpms]) and pause with the transmissions in neutral before shifting gears to the opposite direction. The pause lets the propeller shaft slow down or stop. This reduces transmission wear and tear and facilitates shifting.

For maximum maneuverability, besides twin rudders, your twin-engine Bertram has a right and a left handed propeller. The propellers contra rotate (rotate in opposite directions) to balance engine torque and give your Bertram excellent maneuverability at low speeds.

7.4 Boat Speed

Your Bertram's deep "V" hull cushions pounding by slicing through the waves rather than slapping against them. However, even a Bertram will eventually encounter extreme conditions that a sensible seaman must not ignore. Your speed should be reduced as required by adverse sea conditions in the interest of your comfort, and to reduce any needless strain on the engines and boat structure.

7.5 Maneuvering

7.5.1 Slow Speed Maneuvering

Her twin contra-rotating propellers and twin rudders make your Bertram a pleasure to maneuver even at idle speed. For example, to turn your Bertram in her own length in a confined area, set one engine in forward, and the other in reverse with the rudders amidships, and the throttles at or near idle (but below the 1,000 rpm shift maximum). This turn can be made in either direction. The port engine in forward and the starboard in reverse spins you clockwise. The starboard engine forward and the port in reverse spins you counter-clockwise. If desired, you can speed up this turn by applying rudder and/or throttle in the direction of the spin.

Docking parallel to a dock or pier is a good place to use your Bertram's slow-speed maneuverability. Approach the dock at minimum maneuvering speed, at a 30° angle; and, if possible, against either the tide flow or wind, whichever is greater. When the bow is about five feet from the dock, put the dockside engine in neutral and the other engine in reverse. This reduces your forward movement and will bring your stern smoothly alongside the dock without a jolt. With some practice, this type of docking can usually be accomplished with the minimum of fuss and noise, by using the clutches alone, without steering or using the throttle.

At some time, it may become necessary to operate your Bertram with a single engine. Before this happens, Bertram suggests that it would be prudent to practice with first one engine and then the other to see how your vessel handles. You will see that your vessel must be moving fairly fast after a dead stop before the rudders will "bite" the water sufficiently to make the desired course correction. You will also notice that with only one engine operating, steering while in reverse is very poor.

7.5.2 Cruising Speed Maneuvering

Your Bertram's rudders are stern mounted. This is important because when you turn the helm to make a course change, the stern changes direction first. This is because your rudders are in fact "lifting" surfaces similar to an aircraft's wing. At speed, when you put the rudders over, the lifting force generated as the water passes over the "front" and "back" surfaces of each rudder at different speeds pushes your stern out and away from the direction that you are turning. For instance, when you are getting underway from a dock or pier and you were starboard side to, if you were to put the helm "hard over" to port in an effort to move your bow away from the dock, when you then applied power equally to both engines, your rudder position would push your stern into the dock instead.

Maneuvering at speeds above idle is almost always done with the rudders only and should not normally involve reversing either transmission. You should be aware that there is a practical limit to how far over you can put a rudder after which it becomes just a drag on your vessel, this is why your Bertram is limited to a "hard over" angle of approximately 35° from amidships.

Once your rudders bite, your vessel pivots around a point forward of amidships. The pivot point moves with changing speeds and hull attitudes. Her bow pivots around a circle that is smaller than that of her stern with her bow initially just inside the intended turning track and her stern just outside.

At any speed above idle, she will settle smoothly into a turn due to the forces of the water on your deep "V" hull. As long as your helm is over, the lifting force of the rudders exists, and she will continue to turn. When you return the rudders to amidships, her turn will slow and her track through the water will straighten out. With a vessel of this size, particularly at slower speeds, steering slightly to the opposite direction ("meeting her") can be helpful in settling her in on her new course.

8. Propulsion System.

8.1 General



Coming into contact with moving machinery can result in serious injury.



Loud noises can damage your hearing. To prevent possible hearing loss, before you enter the engine compartment while an engine or generator is running, Bertram strongly recommends that you put on hearing protection (ear muffs or ear plugs) with an OSHA Noise Reduction Ratio of at least 20 dB.

NOTE:

DDEC-Detroit Diesel Electronic Controls are not discussed in this chapter. Refer to the DDEC manuals supplied by the engine manufacturer for complete information.

See the D.C. chapter about the DDEC 12/24v voltage equalizer & power source selector.

8.2 Propulsion System Care

Despite the high quality materials in your engines and propulsion system, plus the proven ruggedness of their design; ultimately, the propulsion system performance and life expectancy very much depends on the care that it is given. Therefore, Bertram suggests that you follow the instructions in the engine/transmission manufacturer's operators manual as to:

- selection of fuel and lubricants;
- scheduled preventative maintenance; and,
- watching the performance instruments carefully.

NOTE: IT IS IMPORTANT that you:

Check the engine lubricating oil level and the coolant level before you start the engines;

check the transmission lubricating oil level with the engine idling and the transmission in neutral; and ,

that you monitor the propulsion system performance gauges especially the first several minutes after engine start up.

8.3 The Diesel Engines

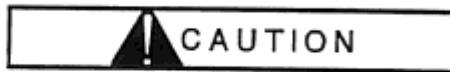

To avoid possible serious engine damage, do not attempt to start or operate your engines until you have read and understood the engine manufacturer's Operators manual.

The engine serial and model numbers are stamped on the engine. The engine lubricating oil fills and dip sticks are on the inboard side of each engine.

All the information you need to operate and to perform routine maintenance on your Diesel engines (including technical data) is contained within the engine manufacturer's Operator's Manual. This manual is supplied as a part of this vessel's documentation package and the sections having to do with the engine operating instructions, lubrication requirements, and preventative maintenance should be carefully read before you try to start or operate your Diesel engines or your Diesel a.c. generator(s).

Engine hour meters are provided for each engine and generator to aid you in scheduling maintenance at the proper interval of time. These meters accumulate engine running time; not time based on engine R.P.M..

For those who wish to become knowledgeable about the Detroit Diesel engines in their boat, Florida Detroit Diesel-Allison, Inc. gives three day seminars for boat owners and captains on marine Diesel engines which includes theory of operations, preventative maintenance, and trouble shooting.

For more information and/or registration, contact the Director of Training; Florida Detroit Diesel-Allison, Inc.; 2295 N.W. 14th Street, Miami, Florida, 33125 (305) 633-5028.

For seminars on other types of diesel engines, contact the engine manufacturer or dealer.

8.4 Engine Operation

8.4.1 Preparing To Start the Main Diesel Engines



Before starting the engines, ensure that the clutch controls are set in the neutral position to prevent accidental boat movement.

NOTES:

- 1) The neutral switch mounted on the gear, at the shift lever, will prevent the engine from cranking if starting is attempted while in gear.*
- 2) If an engine fails to start within 7 seconds; release the "START" switch, wait 2 to 3 minutes, and try again. Excessive cranking results in unnecessary starter wear and battery drain.*
- 3) If the boat has a DDEC engines system, the Fireboy fire extinguisher system must be energized, or the switch moved to the "override" position. Otherwise, the engines will not start.*

8.5 Diesel Engine Starting Procedure

NOTE:

At this time it is most important to be sure that the engine cooling seawater intake seacocks are fully open and the engine cooling seawater strainers are not clogged.

Set both **Main Battery Disconnect Switches** to "ON". These two battery connect/disconnect switches feed battery power to the **Main Supply & DC Distribution Panels**.

- Set the port and starboard ENGINE circuit breaker switches to "ON".
- Set the clutch controls in the "NEUTRAL" position.
- Advance the throttle levers to slightly forward of idle.
- On the system control switch panels, set the ignition "ON/OFF/STOP" switch or ignition "ON/OFF" switch into the "ON" position.

NOTE:

The engine monitor horn should sound and the [LUBE] OIL PRES alarm light should illuminate. If the GEAR OIL TEMP, EXHAUST TEMP, and/or COOLANT TEMP monitor lights are now illuminated (with the engine still cold) this indicates a problem in the alarm circuits. It is important to find and correct this problem before starting the engine.

- Set and hold the "BATTERY PARALLEL" switch in "PARALLEL". (Bertram recommends that you use the "PARALLEL" mode when you start an engine). Release the switch when the engine starts.
- Set either "START" rocker switch into the "START" position, and hold for seven (7) seconds or less, if engine starts.
- Release the "START" switch. (The engine monitor horn should stop and all engine alarm lights should now be extinguished).

Repeat the steps for the other engine.

8.5.1 After the Engine Starts



To avoid severe engine damage, once each engine is started, check for adequate water flow from the exhaust outlet. If flow is not detected, immediately shut down that engine.

A few seconds after each engine is running, visually check the stream of water from its transom exhaust outlet. This stream of mixed water and exhaust gases indicates the seawater cooling system is operating. If the stream is not there, shut that engine down immediately to avoid engine damage, and do not restart it until you determine why no water is flowing.

NOTE:

At this time it is important to be sure that the engine performance gauges are reading correctly.

See the engine manual for engine operation at no load for extended periods of time.

8.5.2 Stopping the Main Diesel Engines

The Diesel engine is stopped by one of the two following methods, depending on the type of engine.

- 1) Move the ignition "ON/OFF/STOP" switch for either the port or starboard engine to the "STOP" position and hold until the engine is fully stopped.
- 2) Move the ignition "ON/OFF" switch to the "OFF" position.

Repeat step for the other engine.

8.6 Fuel System

8.6.1 General

Your fuel system consists of:

- one or more fuel tanks;
- fuel lines;
- fuel selection valves;
- manual shutoff valves; and,
- fuel filters

8.6.2 Fuel tanks, Valves, & Tank Selection

The valves permit you to select the tank from which each engine and the generator(s) draw fuel. The valves connect directly to the fuel tank suction heads.

Diesel engines do not use all the fuel drawn into them, so they have fuel return lines which automatically return all unused fuel to the tank from which it is drawn. The Diesel fuel return lines connect through the tank selection valves, and have no shutoff valves.

See the diagram in the back of this manual for more information.

8.6.3 Fuel Filtering

The fuel travels from each selector valve to a combination fuel filter and fuel/water separator. A filter service valve is located on the fuel line at each engine so you can replace the fuel filter without having the fuel lines drain or leak fuel into the bilge.

NOTE:

If Diesel Fuel does get into the bilge, it is a violation to pump it overboard in U.S. territorial waters.

Each separator assembly has a drain plug at the bottom to allow removal of collected water. You should visually inspect these separators regularly, depending on climatic conditions, and remove the water when required. See Technical Data Sheets in the front of this manual for filter specifications.

8.6.4 Fuel Priming System

If your boat has an engine fuel priming system, simply attach the quick disconnect hose from the pump to the quick disconnect fitting between the six-way valve and the filter. Switch the pump **ON**. Crank the engine to fill the engine-mounted fuel filter. The engine should start. The generator(s) can be primed in a similar fashion.

NOTE:

Limit cranking to seven seconds: wait two minutes before cranking again.

8.6.5 Fuel Fill Ports

Your Bertram has one or more fuel fill ports for each tank on the port and stbd side. Each port is a flush-mounted deck plate with a captive, screw-on cover.

8.6.6 Fuel Gallonage & Gauges

The fuel in the tanks, as indicated by the fuel gauges cannot register accurately as gallonage. The fuel gauge liquid level indications only show the approximate amount of usable fuel remaining in the tanks. Keep this in mind when planning for or during long trips to avoid running too low on fuel and to reduce the chance of running out of fuel at sea. The Technical Data Sheet, shows the approximate relationship between the fuel gauge readings and the actual fuel remaining.

8.6.7 Fuel Quality

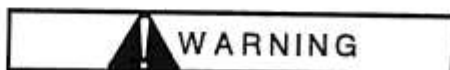

Never add commercially marketed diesohol or gasohol to diesel fuel. Mixing these blends with diesel fuel creates both an explosion and a fire hazard.



Never use galvanized steel fittings in any Diesel fuel system. Diesel oil reacts chemically with the zinc coating to form a powder that clogs filters and damages engines.

Do not store fuel for long periods in your vessel's fuel tanks. Stored fuel will spoil and spoiled fuel can damage your engines.

When using the boat outside the U.S.A., the fuel quality may severely damage the engine fuel delivery system and the engine exhaust system.

Only use the types of clean, high-quality Diesel fuel oil that are specified in your engine manual. Diesel fuel must be clean and free from contamination. Fuel tanks and stored fuel must be inspected regularly for dirt, water, bacteria, and/or water-emulsion sludge.

Very small amounts of isopropyl alcohol (isopropanol) may be used to prevent fuel line freeze-up in winter months. No more than ONE (1) PINT of isopropyl alcohol should or need be added to each 125 GALLONS of Diesel fuel for adequate protection.

8.6.8 Spoiled Fuel

Diesel fuel kept in your vessel's tanks for long periods deteriorates and spoiled Diesel fuel can damage your engines. Therefore, on shorter trips alternate the tank you use. On longer trips, where you expect to use both tanks, Bertram suggests that you use the forward tank first. This reduces the weight forward as fuel is drawn making it easier for you to trim your Bertram to the slightly bow up attitude for both the smoothest possible ride and maximum fuel efficiency. Bertram recommends that, whenever possible, you refill your fuel tanks at the end of each days running to prevent condensation from contaminating the fuel.

8.7 Engine Air System

To keep dust and grit out of your Diesel engines, they are each equipped with airsep on the air intake silencer attached to the input end of each turbocharger. The air filter element in the silencer is replaceable.

8.7.1 Airsep Filters

Walker Engineering Airsep Air Filter and Vacuum Limiter Filter cleaning and service instructions.

NOTE:

For best results and to avoid damage to your Airsep Air Filter and Vacuum Limiter Filter Assembly, use only the Walker Cleaning and Re-oiling Kit. The kit may be purchased from Walker Engineering by calling (818) 782-2154. Failure to clean the Airsep Filter and Vacuum Limiter will affect the operation of the Airsep and may cause damage to the engine.

Pre-cleaning

Remove the air filter element from the airsep. Tap the filter element to dislodge any large embedded particles or dirt. Then gently brush the filter element with a soft bristle brush.

NOTE:

If complete cleaning at this time is impractical, you may re-oil and reinstall the air filter element.

Spray on Cleaner

Spray the Walker Cleaning Solution on to the filter element and let it soak for twenty minutes.

NOTE:

Never use the following methods or liquids for cleaning the filter element or the filters will be destroyed.

- No gasoline cleaning.
- No steam cleaning.
- No caustic cleaning solutions.
- No strong detergents.
- No high pressure water or air.
- No parts cleaning solvents.
- No Diesel fuel.

Rinse Off

Rinse off the filter element with low pressure water. Tap water is OK. Always flush from the clean side to the dirty side. This will remove the particles and dirt and not drive it into the filter.

Drying the Filter

Always dry the filter element naturally. After rinsing, shake off all excess water and let the filter element air dry naturally.

- Do not use compressed air.
- Do not use open flame.
- Do not use heat dryers.

Excess heat will shrink the cotton filter element and compressed air will blow holes in the filter element.

Re-oiling the Filter Element

NOTE:

After cleaning, always re-oil the filter element with Walker Air-Filter Oil before using.

The effectiveness of the air filter is greatly reduced if it is used without oiling. Squeeze the oil out of the bottle and down into the bottom of each pleat—only one pass per pleat. Let the oil wick into the filter element for twenty minutes. Re-oil any white spots that are still showing.

NOTE:

Use only Walker Air Filter Oil. Any other oil will damage the filter element.

Never use any of the following lubricants to re-oil the filter element;

- Automatic transmission fluid.
- Motor oil.
- Diesel fuel.
- WD-40 or other light weight oil.

Maintenance Schedule

The Walker Airsep Air Filter Element may be cleaned two times within one year or five hundred hours, whichever occurs first. The air filter element should be replaced after these periods due to the corrosive nature of a saltwater environment. The Vacuum Limiter must be cleaned every 250 hours, as described below. In addition to the forgoing, the Filter Element and Vacuum Limiter must be cleaned at any time the restriction gauge on the Airsep turns red.

Cleaning the Vacuum Limiter

The Vacuum Limiter must be cleaned after every 250 hours of operation. In addition, it is advisable to clean the Vacuum Limiter each time the Airsep filter element is cleaned. To clean the Vacuum Limiter, remove the entire unit and do not attempt to remove the filter. Immerse the entire unit in the Walker Cleaning Solution and allow it to soak for approximately 20 minutes. The Vacuum Limiter is made of non-corrosive material and will not be harmed. Flush out the Vacuum Limiter with tap water and follow the cleaning and re-oiling instructions for the Airsep filters described above.

For further information contact:
Walker Engineering Enterprises
7405 Havenhurst Place,
Van Nuys, Ca. 91406

8.8 Engine Lubrication System

As with any internal combustion engine, proper lubrication is critical to engine life and performance. A full-flow oil filter is mounted on each engine and all the engine lubricating oil goes through this filter which removes the larger foreign particles without restricting the oil flow. As the oil circulates, all of it is eventually filtered by the full-flow filter. This filter element should be replaced each time the oil is changed. See the Engine Manual for further instructions and maintenance.

8.9 Engine Cooling

8.9.1 General

Your Bertram's Diesels are fresh water cooled. This means that the cooling seawater is taken in through the hull via the slotted strainers, is drawn through the seacocks and the seawater strainers to the pump. The cooling seawater then is pumped through the heat exchanger and from there into the engine exhaust outlet (riser), where it is mixed with the exhaust gases and cools them. To keep the seawater from getting back into the exhaust manifold, the cooling seawater is injected into the exhaust flow at a point several inches below the highest point of the riser and the mixture is expelled over board after passing through the exhaust silencers (mufflers).

The engine blocks, the cylinder heads, the exhaust manifolds, and the turbochargers are cooled with a sealed and pressurized mixture of fresh water and a suitable corrosion inhibitor such as NALCOOL 2000. This coolant mixture is in turn cooled by passing it through the seawater cooled heat exchanger.

8.9.2 Fresh Water and Anti-freeze Mixture

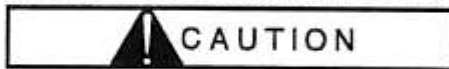

To prevent engine damage caused by silicate dropout from an automotive grade antifreeze, use only antifreeze that meets the requirements of the engine manufacturer. See the manufacturer's engine manual.

Your engine coolant provides the medium for heat transfer to control the engine internal temperature during operation. In an engine having the proper coolant flow, the combustion heat moves through the cylinder walls and the cylinder head into the coolant. Without adequate coolant, normal heat transfer cannot occur within the engine and its temperature will rise rapidly. The coolant solution in your engines must provide the following functions:

- Adequate heat transfer;
- a corrosion-resistant situation in the cooling system;
- prevent the formation of sludge or scale in the system;
- be compatible with the system's hoses and seals; and,
- adequate freeze protection during cold weather operation and boil-over protection during hot weather.

In waters above 70°F., do not use antifreeze in the coolant mixture unless specified by the engine manufacturer. Antifreeze does not transfer heat through the heat exchanger as efficiently as a mixture of fresh water and NALCOOL 2000 (one (1) pint of NALCOOL 2000 to four (4) gallons of water). The use of antifreeze in your coolant presents another problem. Over the years, as the use of aluminum parts increased in automobile engine cooling systems, the antifreeze manufacturers changed their products to include increased amounts of silicates to protect these aluminum components from corrosion. Today, most automobile antifreezes have three to eight times as much silicate as they did several years ago. This includes antifreezes to be used in heavy-duty Diesel coolants.

If a high silicate Diesel antifreeze is over concentrated by evaporation and/or unnecessarily large amounts of corrosion inhibitor supplements are used, excess silicate "drops out" of the coolant and a silica gel builds up in the cooling system's cool, low-flow zones, especially the oil cooler core, the heat exchanger, and the aftercooler. This build up of silica gel restricts coolant flow and causes engine overheating which can result in serious engine damage. In its wet state, the silica gel looks like the antifreeze. When dried, the silicate appears as a white powdery deposit. The gel is non-abrasive, however, it can pick up particles in the coolant and become a gritty, abrasive deposit that can cause excessive wear in the water pump seals.

NOTE:

See the engine manual for the latest information on the above subject.

8.9.3 Seawater Inlet System

The Engine and Generator Cooling, Intake and Exhaust, the water inlet system consists of:

- the below the waterline intake ports;
- the sea-cocks; and,
- the seawater strainers.

Each main engine and the generator(s) has a seawater heat exchanger system. First, the incoming seawater cools the heat exchanger. On the engine side of the heat exchangers is the fresh water engine coolant mixture. Once through the heat exchanger, the seawater is piped directly to the engine exhaust risers mixing section (on Diesels these are called the mixing elbows).

NOTE:

To avoid engine and/or a.c. generator overheating, it is most important that the seacocks be completely open and that the seawater strainers be kept clean .

8.10 Wet Exhaust System

The Bertram exhaust system is either dry with a wet tail section, or completely water jacketed.

In the dry with a wet tail section system, water is injected in the tail section, right before the hose connection reducing the surface and exhaust gas temperatures. In the completely water jacketed system, water is introduced right after the flange keeping the entire riser at relatively low temperature. Whether your vessel is equipped with a dry or a wet system, the flange is always dry (not cooled by seawater) and protected by a thermal blanket. The dry flange operates at exhaust gas temperature, and the blanket must be kept in place at all times during engine operation.

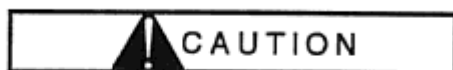

The blanket must be kept in place at all times during engine operation to prevent serious skin burns or combustible material from coming into contact with the hot surface and causing a fire.

8.11 Marine Gears

8.11.1 General

Each heavy-duty marine hydraulic transmission attached to your engines consists of forward and reverse gears and clutches. The transmissions are controlled by the position of the twin transmission control levers mounted on the main control station console.

8.11.2 Operation

Operational information and maintenance procedures are in the manufacturer's manual. Shifting to forward or reverse is explained elsewhere in this manual.

8.12 Propellers

8.12.1 General

Bertram's Engineers calculated a specific combination of propeller diameter and pitch to give your vessel the maximum efficiency based on engine power (at its rated RPM) hull design, vessel weight, and finally extensive testing for proper size. Therefore, any changes in size or pitch could reduce engine performance and/or propulsion system life by placing undue stress on the running gear components. If propeller replacement is necessary, it is vital to use the original size, diameter, and pitch.

8.12.2 Changing Propellers

If in the future, for any reason (such as adding a fishing tower or a similar modification, or if there is a significant change in your vessel's primary use) you feel that a different size or style of propeller could improve your vessel's performance, please send Bertram's Service Department a complete written report on your boat's past performance, including measured speeds at 1,900, 2,100, and at maximum RPMs recorded with an accurate handheld tachometer. The Service Department will then check with Bertram's Design and Test Engineers to see if a change in propellers is indicated.

8.13 Propeller Shafts

Information as to diameter, length, and material of the propeller shafts is shown on the "Technical Data" pages at the front of the manual.

8.13.1 Propeller Shaft Alignment

Two separate propeller shaft alignment procedures were performed by Bertram to ensure that your vessel's propulsion system was aligned correctly at the factory. These same procedures are necessary any time that an engine has been moved or the shaft line changes due to underwater gear repairs.

8.13.2 Parallel or Bore Misalignment

The first procedure is the parallel or bore alignment. In this case, a misalignment occurs when the centerline of the transmissions and the centerline of the mating propeller shafts ARE parallel but ARE NOT coaxial. The allowed misalignment shall be less than 0.005 inches. Since the slip fit of the pilot surfaces of these two shafts holds the shafts in alignment, it is most unlikely that this alignment will change unless you replace an engine, move an engine, or seriously damage the underwater gear. To do a parallel or bore alignment procedure requires precision measuring equipment and a competent technician.

8.13.3 Angular or Face Misalignment

This misalignment occurs when the centerlines of the marine transmission and the mating propeller shaft are NOT parallel and therefore the mating faces of the marine transmission and the mating propeller shaft can NOT be parallel. In the case of angular or face misalignment, the formula to determine allowed amount of misalignment is 0.0005 inches per inch of the propeller shaft companion flange outside diameter, measured at the mating surface of the flanges.

8.13.4 Allowable Angular or Face Misalignment

Using the formula given in the preceding Section and using as an example a 5.0 inch outside diameter companion flange, the allowable amount of misalignment is 0.0025 of an inch. The angular or face misalignment should be checked periodically to ensure the proper alignment and therefore the optimum performance. The initial alignment check is considered a part of the predelivery preparation. After delivery, this alignment is an owner maintenance responsibility.

Bertram recommends that you:

- Open the two couplings before haulout.

To check the alignment after launching:

- Let your vessel settle in the water for a day or two before making the final alignment adjustments.
- Remove all of the bolts in the coupling flanges at the end of the marine gear.
- Slide the shaft aft until the flanges are about 1/4 of an inch apart.
- Press the flanges together by hand with a 0.010 of an inch or larger feeler gauge between them.

NOTE:

At this point gauge thickness is not vital. What is important is that as you bring the flange faces closer together that the differences between the opposite side gaps stay within the allowed tolerance. You find this difference by subtracting the thickness of the thinner feeler gauge from that of the thicker.

- Place a feeler gauge between the flanges at 90° or less intervals around the flange to assure equal clearance.
- With correct alignment, the 0.010 inch or larger feeler gauge will be a tight fit all around the coupling edges.

- Repeat the three previous steps, while gradually moving the two flanges closer together until they touch using the formula as previously discussed..

Engine alignment is best accomplished by an experienced mechanic working with the proper tools. Keep this in mind before attempting to move a marine engine on its mountings.

8.14 Propeller Installation

Propeller installation completes your vessel's propulsion system. With the engine output converted to vessel movement at this point, mating the shaft to the propeller must be done properly to provide maximum shaft and propeller life. If you must replace either the propeller or the shaft, follow these guidelines:

- Inspect the shaft keyway and the key for the proper radii (see Sketch on Propeller Installation Sketch). The key must fit snugly in its slot.
- Check the fit of the propeller on the shaft with the key.

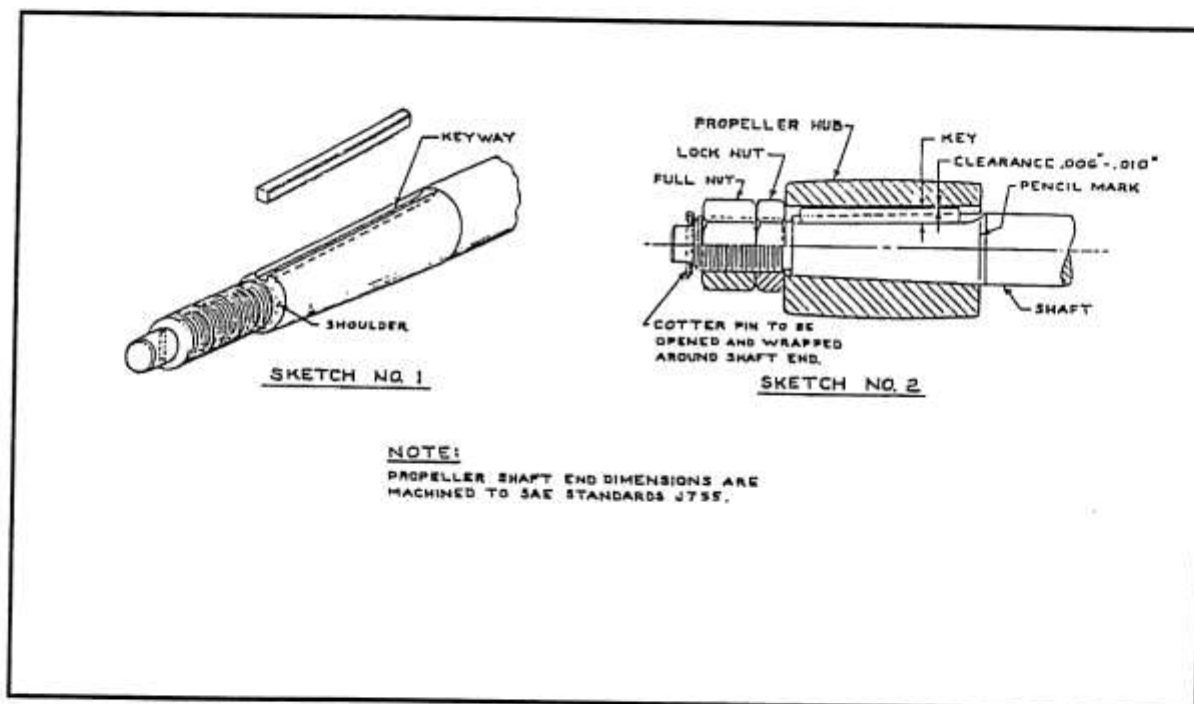

Propeller Installation Sketches

- If the key does not fit, carefully file the propeller keyway using gentle and even file strokes along the whole keyway.
- Place the propeller on the shaft (without the key), and seat the propeller on the shaft taper by lapping into place. The fit should be tight with no wobble and no space between the shaft and forward and aft ends of the propeller hub.
- Mark the location of the propeller on the shaft at forward end of the hub with a sharp pencil as shown on Sketch 2.
- Remove the propeller.
- Install the key into the shaft keyway.
- Reinstall the propeller.
- Ensure that the propeller is fully seated with the forward end of the hub touching the pencil line.
- Use a feeler gauge to check for 0.006 and 0.010 inch clearance between the top of the key and the bottom of the keyway in the propeller hub.
- Remove the propeller.
- Coat the bore with any non graphite, waterproof grease.
- Reinstall the propeller.
- Install the plain (full) nut.
- Torque the nut with a wrench to seat the propeller.
- Remove the full nut and install a jam (half) nut.
- Tighten the jam nut slightly more than finger tight.
- Install full nut.
- Lock both nuts together by holding the jam nut while tightening the full nut. The completed installation should match Sketch 2.
- Install a cotter pin and bend the legs.

The sequence and method of nut installation, as described above, is in accordance with S.A.E. Specifications #J-755.

8.15 Propeller Shaft Replacement



When using any type of hammer against metal, be sure to wear safety glasses and to take all other usual precautions against injury.

8.15.1 General

To replace a propeller shaft it is necessary that you remove the hexagon or slotted nut that holds the coupling on to the engine end of the propeller shaft. To do this you must first loosen and remove the bolts that fasten the coupling to the transmission flange and push the shaft aft until you have room to work (4 to 6 inches).

8.15.2 Coupling Removal

To remove the coupling nut:

- Place standard, correct size socket wrench in the coupling shaft nut cavity (in the center of the coupling flange), so that the nut is secure within the socket. See Drive Line Assembly Sketch.

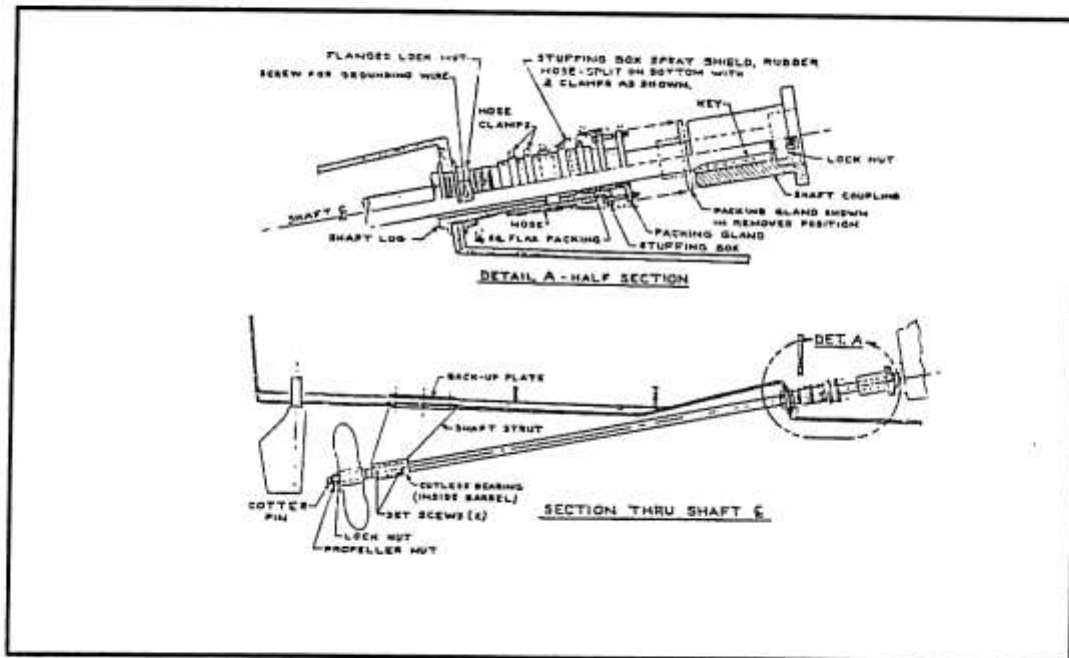

The Drive Line Assembly Sketch

- Bertram recommends that you use a small to medium lead, lead shot, or other soft faced mallet to strike the breaker bar fitted to the socket wrench sharply to loosen the nut. Repeat if necessary.
- Hold the shaft with one hand and use the wrench to unscrew the nut.
- Remove the nut.
- Tap around the coupling's aft end with the lead mallet to remove the coupling from the tapered propeller shaft.

8.15.3 Coupling Installation

- Place the new shaft in position.
- Inspect the shaft keyway and the key for the proper radii (See Drive line Assembly Sketch).
- Check the fit of the key in the shaft keyway. If the key does not fit, carefully file the coupling keyway using gentle and even file strokes along the whole keyway.
- Place the coupling on the shaft (without the key) and seat the coupling on the shaft taper. The fit should be tight with no wobble and no space between the shaft and forward and aft ends of the coupling hub.
- Mark the location of the coupling on the shaft at forward end of the hub with a sharp pencil.
- Remove the coupling.
- Insert the key into the shaft keyway, ensuring that the key is clear of the radius at the shaft end of the propeller shaft keyway.
- Reinstall the coupling.
- Ensure that the coupling is fully seated with the forward end of the hub touching the pencil line you made.
- Use a feeler gauge to check for 0.006 and 0.010 inch clearance between the top of the key and the bottom of the keyway in the coupling hub.
- Remove the coupling.

- Coat the bore with any non graphite, waterproof grease.
- Reinstall the coupling.
- Place the nut on the end of the shaft.
- Use the wrench to tighten as far as possible, taking care not to mar or scratch the shaft.
- Using the lead mallet, strike the ear of the wrench two (2) or three (3) times to tighten the nut.

8.16 Shaft Log And Stuffing Box

8.16.1 The Shaft Log

The shaft log recess is the tunnel in which each propeller shaft turns. In your Bertram, the shaft logs are a part of and are constructed of the same material as is the hull as shown in the (Drive Line Assembly) sketch. Each stuffing box is attached to its shaft log recess by a flexible hose held in place by hose clamps. This flexible hose serves to absorb any normal shaft vibration.

8.16.2 Stuffing Boxes



Do Not over tighten the packing gland on the stuffing boxes. If this gland is too tight, the packing may become glazed and the shaft may be scored. A slight drip is necessary.

Stuffing boxes keep water from leaking around the shaft and into the boat. The stuffing box components are the braided flax packing and the packing gland. A tight packing gland stops excessive stuffing box leakage. However, a slight drip is necessary (about one drop each 3 seconds). Seawater lubricates the propeller shafts. If leaking is excessive, retighten the packing gland. Do not over tighten or you may glaze the packing and could score the shaft. If the packing is too tight, the gland will get too hot to comfortably hold with your bare hand. When running at full speed, the gland should feel warm.

8.16.3 Repacking a Stuffing Box

If you must repack the stuffing box:

- Remove the boat from the water;
- unbolt the packing gland;
- remove the sprayshield;
- slide the packing gland forward on its shaft;
- remove the old packing and install sufficient 1/4 inch by 1/4 inch new packing rings to come about 1/4 inch of filling the stuffing box. Always use tallow flax packing and do NOT spiral the packing around the shaft. Each packing ring must be separate, with the ring opening approximately 30 degrees away from the adjacent rings;
- slide the packing gland aft;
- replace the sprayshield;
- tighten the packing gland until the shaft will not turn to seat the packing;
- relaunch the boat;
- back the gland off until the shaft is free to turn and there is the slight drip necessary for proper shaft lubrication; and,
- run the shaft for a while, reset if necessary.

8.17 Shaft Log Sprayshield

Each stuffing box has a sprayshield to prevent dripping water from being sprayed around the engine compartment.

8.18 Rudder Stuffing Boxes

When tightening the packing gland, remember that it is not necessary or desirable to have a rudder stuffing box drip, only be sure the rudders turn freely. Otherwise, the two rudder stuffing boxes are packed in the same manner and with the same material as are the two propeller stuffing boxes,

8.19 Engine Performance Gauges & Monitor System

8.19.1 General

Your Bertram has two identical sets of performance gauges mounted on the instrument panel. One set is for the port engine and transmission. The other set is for the Starboard engine and transmission. Each gauge has a purpose, and that purpose is to assist you in the efficient and safe operation and proper maintenance of your Bertram.

Therefore, you, the operator should:

- Become familiar with the function of each of your Bertram's gauges;
- make it a good habit to check your gauges frequently when under way;
- in particular, check your gauges carefully when you first start your engines; and,
- note what constitutes the "normal" readings or operational ranges of each of the gauges. See the engine manuals for the correct specifications.

You should be aware that:

- all of the flybridge console engine gauges operate off of your Bertram's electrical system through the ignition circuit; and,
- that all of the gauges do not necessarily return to any particular position when the ignition is switched "**OFF**".

Note:

If your boat is equipped with DDEC or other electronic engine displays, the remainder of this chapter may not apply. Refer to the engine manuals supplied to you by the engine manufacturer.

In addition to the gauges for each engine and each transmission, your Bertram is equipped with an audio/visual engine monitor system that sounds an alarm (horn) and illuminates red warning lights on the instrument panel.

8.20 Engine Performance Gauges

8.20.1 Engine Coolant Temperature Gauges

The two (2) engine coolant temperature gauges each independently indicate the temperature of the coolant circulating through their respective engines in degrees Fahrenheit and Celsius. Any sudden rise in the coolant temperature reading could indicate a major engine problem and that engine should be immediately put into "IDLE" and then shut down until the cause of this change is determined.

8.20.2 Engine Lube Oil Pressure Gauges

There is one engine lubricating oil pressure gauge for each main engine. The (2) two engine oil pressure gauges are calibrated in pounds per square inch, gauge and Millibars. Any sudden drop or rise in the lube oil pressure reading could indicate a major engine problem and that engine should be immediately put into "IDLE" and then shut down until the cause of this change is determined.

8.20.3 Gear Oil Temperature Gauge

There are two (2) transmission gear oil temperature gauges, one for each engine. Each transmission gauge shows the operating temperature of the oil in that transmission and is calibrated in degrees Fahrenheit and degrees Celsius. Any sudden rise in the gear oil temperature reading could indicate a major transmission problem and that engine should be immediately put into "IDLE" and then shut down until the cause of this change is determined.

8.20.4 Gear Oil Pressure Gauge

There are two (2) transmission gear oil pressure gauges, one for each engine. Each gear oil pressure gauge shows the operating pressure of the oil in that transmission and is calibrated in pounds per square inch, gauge and millibars. Any sudden drop or rise in the gear oil pressure reading could indicate a major transmission problem and that engine should be immediately put into "IDLE" and then shut down until the cause of this change is determined.

8.20.5 D.C. Voltage Gauge

There are two (2) dc gauges that allow you to monitor the voltage level in its battery bank. Normal operating voltage is 12.5-14.1 volts for a nominal 12 volt system and 25.0-28.2 volts for a nominal 24 volt system.

8.20.6 The Tachometer

The two tachometers mounted on the control console instrument panel displays a read-out of your main engines' Revolutions Per Minute (rpms) which serves several purposes:

- It gives a good indication of relative engine performance;
- it permits engine speed settings for fuel efficiency;
- it helps in estimating speed which is useful to solve navigational problems involving speed, time, and distance; and,
- it serves as a visual reference to help balance engine speeds.

Diesel engines perform the best when they are operated at relatively steady speeds. Therefore, any substantial change in either engine's rpms from a fixed power setting or drop from your Bertram's maximum rpms is a good indication that something could be wrong. You should stop and check your engines and running gear to limit any damage.

While using your tachometer to make a series of timed test runs back and forth over a measured course at different rpm readings provides a good tool for estimating speed, it must be stressed that there is no direct correlation of rpm's to the speed of the boat across the bottom due to:

- Slippage of the propellers;
- condition of the propellers;
- the effect of wind on the vessels superstructure;
- the effect of tides or currents;
- the condition of the vessels bottom; and,
- variations in the load.

8.21 Engine Performance Monitor System

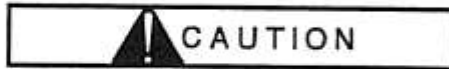

If the Engine Monitor horn sounds and any engine monitor light illuminates indicating an engine or transmission problem, you must immediately:

- Throttle the engine back to idle speed;
- shift the engine into NEUTRAL; and,
- Shutdown that engine.

NOTE:

An illuminated monitor light indicates an open circuit condition in the normally closed loop circuit. This open circuit can mean either a possible engine problem or a problem with the monitor circuit. Always assume an engine problem first.

Each engine and transmission has a monitor system consisting of a horn and indicator lights mounted on the main control console. These lights will indicate to you which engine has the problem and what that problem may be.

8.21.1 Engine Monitor Operation.

Each engine and transmission has an independent monitor system that consists of a horn and a set of four (4) red indicator lights mounted on the main control console to warn you in case either of the following two possibly dangerous conditions exist:

- 1.)The lubricating oil pressure (OIL PRES) in that engine has dropped below a preset level. If this occurs, a horn will sound and the red port or starboard monitor indicator lamp will illuminate.
- 2.)If any one or more of the following three engine operating temperatures are too high:
 - the engine coolant temperature (WATER TEMP); the horn will sound and the port or starboard red monitor indicator lamp will illuminate if either engine coolant temperature exceeds its specified upper limit.

- the engine exhaust temperature (EXHAUST TEMP); the horn will sound and the red port or starboard monitor indicator lamp will illuminate if the exhaust system temperature of either engine exceeds a specified upper limit.
- transmission temperature (GEAR TEMP); the horn will sound and the red port or starboard monitor indicator lamp will illuminate if the gear oil temperature in either transmission rises above a specified upper limit.

There are two sets of two push-button switches. One switch in each set is labeled "**TEST**" and allows you to check the operation of the monitor horn and the port and starboard engine performance monitor lights and the monitor light circuits. The other switch is labeled "**SILENCE**". The switch sets are labeled "**PORT ENGINE MONITOR**" and "**STBD ENGINE MONITOR**".

The engine performance monitors horn and lights have done their job once they have alerted you to a possible problem. Once alerted, you can temporarily silence the horn by depressing the button switch labeled "**SILENCE**". However, the illuminated red warning light remains illuminated until the problem is corrected. A silenced engine monitor horn will sound again if there is another problem in the system.

8.21.2 Engine Monitor Trouble Shooting

Once alerted to a potential problem by the engine monitor horn and the illumination of one or more engine monitor lights, you can isolate and possibly correct the problem by taking the steps listed in the following procedures:

a) Engine Oil Pressure. If the engine monitor horn sounds and either engine "OIL PRES" light illuminates to indicate that it has detected a low engine oil pressure condition, check the following:

- Read the engine oil pressure gauge (verify the low oil pressure condition).
- Low lube oil in the crankcase.
- A leak in the oil system.
- A defective monitor circuit or switch.

b) Coolant Temperature. If the monitor sounds and the engine "WATER TEMP" light illuminates indicating that it has detected an engine over-heat problem, check the following:

- Read the engine temperature gauge (verify the high temperature condition).
- Low coolant in the heat exchanger.
- A restricted seawater strainer. [The "EXHAUST TEMP" light may also illuminate.]
- A closed or partially closed seacock. [The "EXHAUST TEMP" light may also illuminate.]
- Defective water pump(s).
- A defective thermostat.
- A defective monitor circuit or switch.
- A collapsed water suction hose [check for this problem with the engine running at high speed and with no load, but after the engine has cooled down].

c) Gear Oil Temperature. If the monitor sounds and the "GEAR TEMP" light illuminates indicating a gear box overheat problem, check the following:

- Low transmission fluid.
- Clutch slipping (check control cable adjustment).
- Transmission cooling system.
- A defective monitor circuit or switch.

d) Exhaust Temperature. If the monitor sounds and the "EXHAUST TEMP" light illuminates, that indicates an exhaust system overheat problem, check the following:

- The flow of water from exhaust outlet at transom.
- Restricted seawater strainer.
- Closed or partially closed seacock.
- Defective sea water pump(s).
- A collapsed water suction hose [check for this problem with the engine running at high speed and with no load, but after the engine has cooled down].
- Defective exhaust cooling seawater temperature sensor.

9. D.C. Electrical System

9.1 General

The direct current electrical system on your Bertram is powered by two banks of wet-cell, marine batteries located in the engine room. Each battery bank is used to start the main engines, a.c. generator(s), and supply d.c. power to on-board electrical and electronic equipment. The "**D.C. Distribution Panel**" is in the cabin.

See the d.c. electrical drawings in the back of this manual.

9.2 Battery Banks

The battery banks are charged by one of the following sources:

- the a.c. shore power source via the dc converter(s);
- the on-board a.c. generator via the d.c. converter(s); or,
- the main engines d.c. alternators.

Except for the momentary paralleling of the battery banks for starting the main engines or the a.c. generator(s), the two battery banks are completely independent of each other.

9.3 D.C. Power Distribution

9.3.1 D.C. Main Supply Panel

This panel contains both main battery disconnect switches, the generator disconnect switch, windlass switch and fuse, parallel solenoid, plus miscellaneous fuses for monitors, bilge pumps, and power feeds to distribution panels. The fuse descriptions are on the face of the panel as well as in the d.c. electrical schematics provided by Bertram Yacht.

9.3.2 D.C. Distribution Panel

The "D.C. Distribution Panel" contains the port and stbd main and branch circuit breakers. Additionally this panel has:

- A battery condition voltmeter with port and stbd battery selector switch to allow you to read the voltage level (battery bank condition) on either battery bank;
- the Holding Tank Monitor;
- the Grey Water Tank Monitor;
- the Bilge Flood Monitor;
- the Engine Room Overheat Monitor;
- the Fresh Water Tank gauge along with its control switch(es); and,
- provision for additional circuit breakers to protect d.c. equipment that you may wish to add later.

9.4 D.C. Equipment Protection

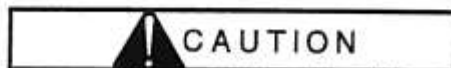

Do not replace existing circuit breakers or fuses with circuit breakers or fuses having a higher trip value than the originals. Such modification could cause equipment and/or circuit failure and/or fires.

A tripped circuit breaker or blown fuse may indicate a problem in that circuit or in the equipment protected by that circuit breaker or fuse. If the same circuit breaker continues to trip or the fuse blows repeatedly, the cause must be found and corrected to avoid possible equipment damage. As stated in the above caution, under no circumstance should any circuit breaker or fuse be replaced with one having a higher ampere value than those that are already in any of your vessel's circuits.

9.5 Battery Disconnect Switches



Battery switches are designed for use under normal operating conditions. If this switch opens the d.c. circuit while the engine is being cranked, the switch should be replaced as-soon-as you can to avoid future failure.

The main battery disconnect switches are mounted on the "MAIN SUPPLY PANEL". These switches connect and/or disconnect the batteries from the ship's d.c. circuits. To activate your vessel's d.c. system, the main battery disconnect switches must be "ON". However, Bertram suggests that these switches be left on "OFF" whenever your vessel is left unattended, especially if it is to be unattended for long periods.

The battery disconnect switches do not control the d.c. power to the battery converter(s). Provided that the a.c. shoreline is plugged in, the converter(s) keeps the batteries charged during those periods when your vessel's a.c. generator is not operating, for instance when your vessel is unattended. Also, power to operate the bilge pumps, and fire and bilge flood monitors is not interrupted by the "OFF" position of the disconnect switches.

9.6 Battery Paralleling Systems

The battery system has two (2) battery paralleling methods:

- Momentary battery paralleling to start the main engines and generator(s) during temporary low battery conditions; and,
- Emergency (permanent) battery paralleling for use when an alternator fails, the momentary paralleling solenoid circuit fails, or the d.c. converter fails to charge both battery banks. Not all models have this feature.

NOTE:

The emergency battery parallel system is intended for emergency use only. If the batteries are permanently paralleled, they will both charge and discharge (go dead) at the same rate.

Do not use this system on a continual basis because of the possibility of both battery banks going dead and leaving the engines and generator(s) without a source of starting power.

9.7 12/24V D.C. Voltage Equalizer for DDEC

NOTE:

If your boat does not have a 24v battery system, disregard the following information .

The voltage equalizer is a device that will keep both 12v batteries of the same 24v battery bank at an equal state of charge when uneven loads are applied to the individual 12v batteries of the 24v bank. It is a device that draws amperes from the 24V (two 12v batteries in series) battery bank to charge one of the 12v batteries of the same battery bank. The 12v battery being charged is the one at the ground (low) end of the 24v bank. Never connect a 12v load to the high end battery of the 24v bank.

A voltage equalizer is used when it is desirable to draw a 12v load from a 24v battery system rather than installing a separate 12v battery and charging device(s). If an equalizer was not used, the battery bank would quickly become unbalanced and cause power and battery failure. A marine converter, when used alone, is not suitable for this type of charging because it senses the overall voltage of the 24v bank, and it is not capable of sensing unbalanced loads within the battery bank.

The system is protected by fuses in the 12v and 24v power feeds of the equalizer. The fuses are located at the source of battery power to the equalizer. There is also a push button circuit breaker on the equalizer to protect it from a short circuit.

Bertram uses port and stbd battery equalizers to provide power sources for the 12v DDEC on the two Detroit Diesel engines when used on boats with 24v battery systems. Generally, the first hint of a 12v low battery condition is detected by the DDEC read-out display on the flybridge control console. The voltage will drop below the normal reading of 12.5-14 volts. At some point, if the voltage continues to fall, the engine will fail to run due to low voltage for the DDEC electronics. Be aware; the port and stbd batteries 24v gauges on that same console may not show enough drop in voltage to indicate a serious problem.

If an engine stops because of low voltage, you may be able to crank and run the stopped engine by using the emergency parallel switch on the face of the "**D.C. Main Supply Panel**" and/or switching the battery source to the DDEC electronics system, in the engine room "**D.C. DDEC Power Source Panel**". Be aware; the DDEC engine cranks on 24v but runs on 12v. 24v engine cranking could mis-lead you to believe that sufficient voltage is being supplied to the 12v DDEC, when it is not. Use the DDEC display to monitor the correct voltage to the DDEC electronics.

See the d.c. electrical drawings provided by Bertram Yacht for complete details of the equalizers circuits, including the DDEC engine room power source panel.

Read the voltage equalizer sheets provided by the manufacturer for additional information.

9.8 D.C. DDEC Power Source Panel

NOTE:

This section applies to both 12v and 24v battery systems.

Boats with 12v engine cranking systems will disregard the discussion about 24v engine cranking since both the DDEC and starting circuits are 12v.

The "**DDEC Power Source Panel**" is supplied by Florida Detroit Diesel-Allison, Inc.. This panel will allow the operator to switch the battery source to the port and stbd engine DDEC electronics. The DDEC electronics are normally operated with the port engine DDEC operating from the port battery bank and the stbd engine DDEC operating from the stbd battery bank. If low battery problems cause either the port or stbd engine DDEC to fail and the engine stops running, the DDEC can be switched to the opposite battery bank. Both DDEC units can be operated from the port or stbd battery bank until the problem is fixed.

24V Battery Systems Only: The "**DDEC Power Source Panel**" does not control the voltage to the engine 24v starting circuits or engine 24v alternators.

See the previous sections for temporary solutions to DDEC starting or battery charging problems.

10. A.C. Electrical System

10.0.1 General

All of your vessel's a.c. equipment uses either 120 or 240 volt, 60 Hertz power. When you are at sea, at anchor, or if you are docked where usable commercial power is not available, your Bertram's power is supplied by the on-board 120/240V a.c. generator(s). Where dockside power is available, your Bertram can use the 120/240V a.c. through the a.c. shore cord.

This power is controlled and distributed from the 120/240V a.c. distribution panel in the salon. The voltage, frequency and amperage meters on the a.c. salon distribution panel monitor the power source in use.

See the a.c. electrical drawings in the back of this manual.

NOTE:

If your boat has the European, 220Vac/50Hz electrical system, disregard the references to 120/240V a.c., 60Hz and G.F.C.I. milliamperage ratings.



To avoid circuit overloading and tripping the main circuit breakers, do not exceed the current draw of the shore line or generator main circuit breakers.

To avoid power selector switch damage, you must set all main circuit breakers to "OFF" to remove the ac ampere load or turn off all the branch circuit breakers before switching from generator power to shore power or vice versa.

If the voltmeter reading drops below 110V or 220V ac, any ac motor in use may be damaged.

10.1 A.C. Distribution Panel

This panel is divided into three general areas. Shore-Generator power selector with meters, generator controls, and circuit distribution.

10.1.1 Shore-Generator Power Selector

The selector switch allows you to select between shore and generator power. This area also has an ammeter with an "L1-L2" switch to monitor the load on both power leads of the 240V a.c., a frequency meter, voltmeter, and a shore power light to indicate an available power source.

Exception: The 60' Convertible has two(2) shore power sources, two(2) generators, and two(2) distribution panels (A & B). The general discussion in this chapter will still apply.

NOTES:

The European panel also has "normal" and "reverse" shore system polarity lights. A "reverse" polarity condition indicates that the shore system neutral and hot power leads on the dock end of the shoreline are reversed. The shore power system must be immediately disconnected to avoid damage caused by reduced circuit breaker protection for the a.c. circuits.

10.1.2 Generator Controls

This area contains the controls to start the generator(s), a momentary battery parallel switch, and a light to indicate an available power source.

10.1.3 Circuit Distribution

This area contains the single pole-120V & two pole-240V branch circuit breakers for the a.c. circuits aboard your boat. A couple of spare circuit breaker mounting holes are provided for later circuit additions by your technician.

10.1.4 Loss of Power

Loss of power may be caused by shore system failure at the dock, a.c. main shore breaker in the cockpit has tripped, an a.c. branch breaker has tripped, or the a.c. generator main breaker on the generator control box has tripped.

10.2 A.C. Generator System

To satisfy your vessel's a.c. power requirements while under way, your vessel has a standard generator(s). This generator is located in the engine room, inside a sound shield.

The "Generator Controls" on the salon panel gives you control over the generator's operation.

Read the manual provided by the generator manufacturer for complete operation and maintenance of the unit(s).

10.2.1 Before Starting the generator

- Check to be sure that the generator cooling seawater seacock is open.
- Check that seawater strainer is clean of debris.
- Check to be sure that the heat exchanger expansion tank on top of the generator is full of the proper coolant.
- Check the generator lube oil level.
- Set both the "PORT BATTERY" and the "STBD BATTERY" main disconnect switches to "ON".
- Set the "GENERATOR BATTERY DISCONNECT SWITCH" to "ON".

10.2.2 Starting the Generator



If the generator won't start after several tries, its waterlift muffler may filled with water. To keep seawater out of the generator exhaust manifold, use the drain plug to empty the muffler.

When starting your generator, do not exceed 20 seconds of warm-up or 20 seconds of cranking. Wait 2 or 3 minutes before trying again.

The generator controls are located on the "Generator Controls" panel.

On this panel:

- Depress the generator "Bypass-Preheat" switch for 10-20 seconds depending on the temperature.
- While depressing the "Bypass-Preheat" switch, depress the "START" switch until the generator starts. Do not exceed 20 seconds of continuous cranking.
- The GEN. RUN lamp illuminates when the generator is running.
- Release the switches.

- After starting the generator, check to be sure that seawater is flowing from the exhaust outlet on your vessel's transom corner. If there is no flow of water, to avoid damaging the generator, immediately shut it down until you solve this problem.

To get electric power from the generator:

- set the Power Selector switch to Generator(ship).
- switch "ON" the circuit breakers to operate the desired equipment.

10.2.3 Stopping the Generator.

NOTE:

Before stopping the generator, remove the ac load by setting the power selector switch(s) to "OFF".

- Manual Stop - Momentarily depress the "START-STOP" switch in the "STOP" position.

Automatic Shutdown - Your generator has an automatic shutdown system that stops that Diesel engine before any of the following faults cause damage to your generators:

- Low Oil Pressure; and/or,
- High Water Temperature.

10.3 A.C. Shore Power



**To minimize shock hazard:
Unplug shore-power.
Close shore power inlet cover tightly
Do not alter shore power cable connections.**

Do not cut or disconnect the green grounding conductor in the shore cord at the dock outlet or the boat inlet. This conductor is needed to provide the same ground potential between shore ground and your boat's ground and minimizes the shock hazard to persons on the boat or in the water.



Before connecting or disconnecting the shore cord, ensure that the the main circuit breaker is "OFF" or that the power selector switch is "OFF". This will help to prevent connector arcing and fitting damage.

The shore cord has a twist-to-lock fitting. Ensure that this fitting is properly locked in place before switching the shore power main circuit breaker to "ON". This will help to prevent connector arcing and fitting damage.

The shore inlet is rated at 50 Amperes. To protect your inlet fitting from damage and prevent the inlet circuit breaker from tripping, do not exceed 50 Amperes current draw.

10.3.1 The Shore Power

Your Bertram has a standard Cablemaster shore cord reel system. The shore cord and its plug are accessed from inside a weathertight receiver in the cockpit. The shore power feeds into the "A.C. Power Selector" switch as previously described.

10.4 Circuit Protection



Do not replace existing circuit breakers or fuses with breakers or fuses having higher trip values than the original. Such modification could cause equipment and/or circuit failure and/or fires.

A tripped circuit breaker or blown fuse may indicate a problem in that circuit or in equipment protected by that circuit breaker or fuse. If the same circuit breaker continues to trip or the fuse blows repeatedly, the cause must be found and corrected to avoid possible equipment damage. As stated in the above caution, under no circumstance should any circuit breaker or fuse be replaced with one having a higher trip value than those that are already in any of your vessel's circuits.

10.5 Ground Fault Circuit Interrupters (G.F.C.I.)

10.5.1 General

Circuit breakers and fuses on this vessel protect you and on-board equipment and circuits against over loads and short circuits. However, circuit breakers and fuses may not protect people from electric shock. Ground fault, is a leakage of current to ground, often through the body of a person who is the electrical path to ground. It is the most common type of current leakage responsible for electric shock accidents.

Your Bertram is equipped with Ground Fault Circuit Interrupters (GFCI) protection, in the galley, toilet areas, wet decks, and engine room.

Except for a red **"RESET"** push button and a black **"TEST"** push button located between the two receptacles, GFCI receptacles look similar to the common, every-day, double 120V ac receptacles.

10.5.2 GFCI Outlet Operation

For all practical purposes, each GFCI outlet is a standard double 120V ac outlet except that if the GFCI outlet senses 6 or more milliamperes of ground fault current this outlet will then act as a circuit breaker and open this circuit. At that time, the **"RESET"** push button will extend out of the receptacle plate. To reset a tripped GFCI outlet, depress the red **"RESET"** push button until it locks in place. If the push button will not reset, there is a problem with the appliance being used or with that part of your 120V ac circuitry. The problem requires the attention of a competent marine electrician.

To test a GFCI outlet, depress the black **"TEST"** push button switch. The red **"RESET"** push button switch should pop out. If it does, depress the **"RESET"** push button until it is once more locked in place. If the **"RESET"** push button does not pop out have it checked by a competent marine electrician.

10.6 International Shore Power



A 220v/50hz system will **NOT** operate safely on a 120/240v, 60hz system, nor will a 120/240v, 60hz system operate safely on a 220v/50hz system.

If this vessel will be operated in foreign ports that has shore power of 220V, 50Hz, instead of 120/240Vac-60Hz, Bertram's international option must be installed. The international system is a 2-wire 220V ac, 50Hz, with ground system designed for shore side operation. All standard equipment is 220V ac and will operate on 50Hz. The a.c. generator is a 220Vac/50Hz, 2-wire unit. 120V ac is not provided in this system.

NOTE:

If your boat is equipped with a 2-wire grounded 220Vac/50Hz electrical system, then all references in this operator's manual to 120V or 240v, 60Hz should be substituted with 220Vac/50Hz.

10.7 Automatic Converters

The on-board ac to dc converter(s) changes the a.c. input power into d.c. output power which will charge the appropriate battery bank. The converter(s) is fully automatic and will maintain the batteries in a fully charged condition.

Bertram recommends that the converter(s) normally be left in the "ON" position with either shore power or the generator supplying the power.

10.8 Galvanic Isolator

The U.L. listed galvanic isolator on your Bertram is a solid state device designed to stop the accelerated underwater corrosion that can occur when the vessel is dockside and connected to shore power. This is a passive unit that requires no maintenance and it acts as an electrical filter to prevent the flow of dc galvanic corrosion currents through the power system (green "safety") grounding conductor without sacrificing the safety features of the ac grounding system.

A grounding conductor is not normally a current carrying conductor; however, there are abnormal conditions when an ac current may flow in this conductor. Two of the possible conditions are:

- A breakdown of the insulation between a current carrying conductor and the grounding conductor.
- Incorrect or inadequate wiring on shore or on your vessel.

To minimize the shock hazard when your vessel is connected to shore power, the shore power green grounding conductor is electrically connected to the vessel grounding system. This, in effect, electrically connects your vessel's underwater metal fittings (bonding system) to the shore ac grounding system and to other vessels which are connected to the shore grounding system. This condition can cause difficulties, in that your expendable zinc anode system may be overloaded to the point where it cannot furnish sufficient protection against this type of corrosion. To stop the overload, the galvanic path must be blocked without cutting the green grounding conductor in your shoreline. To do this, a galvanic isolator is wired in series with the (green) shoreline grounding conductor and the ac panel or power selector switches.

11. Air Conditioning System

11.0.1 General

The components in your onboard air conditioning system are designed and built for saltwater marine use. Your system operates with sea-water cooled, reverse-cycle, condensers and either heats or cools as required for your comfort.

The condensate from the fwd air conditioning cooling unit(s) drains into the gray water sump tank(shower sump) and is pumped overboard. The salon cooling unit drains into the engine room bilge.

11.0.2 Condensing Units

All units are 240V a.c. powered, by circuit breakers on the salon a.c. distribution panel.

11.0.3 Air Conditioning Controls

The air conditioning cooling units in the staterooms and salon, each has an electronic SMX control (i.e., a thermostat, a temperature regulating control, de-humidifier, and a fan speed adjustment control.

NOTE:

It is very important that you read and understand the Cruisair SMX manual before you attempt to start or operate your vessel's air conditioning units. How to set all of the SMX controls is fully explained in the manual.

11.0.4 Seawater Cooling System

NOTE:

The air conditioning cooling water seacock must be set to "OPEN" before any air-conditioning system is switched "ON". Failure to do this or failure to keep the seawater strainer and filter clean will cause a thermal overload and a system shut-down.

The cooling seawater supply system consists of a seacock, a strainer, and a pump. Cooling seawater is drawn up through a through-hull fitting and drawn via a strainer. From the strainer, the seawater goes directly to the pump, then through the air conditioning heat exchanger and back overboard. The seawater pump is automatically switched "ON" whenever any air conditioning is switched to "ON".

NOTE:

When starting the air conditioning system, always visually check that there is a seawater discharge from the hullside fitting to ensure that the pump is operating properly. If the boat has been lifted from the water, the seawater may drain from the system. When the boat is returned to the water, the air must be bled from the strainer before the a/c pump is operated or it will not pump water.

11.0.5 Air Conditioning Operation

The power source and circuit breakers for your air conditioning is the 240 Vac Distribution Panel. To operate your air conditioning, you must first decide if you are going to use shore power or your onboard generator and set the **"SHORE/OFF/SHIP"** selector switch to the power source of choice.

A detailed explanation of how to start, operate, adjust, and stop your on-board air conditioning system is given in the manufacturer's "Owner's Operation Manual". This operation manual is included as part of your vessel's documentation package, and the information in it is therefore not repeated in this manual. To get the maximum comfort from your cooling/heating system, you must read and thoroughly understand the system operating instructions.

12. Toilet (Head) System

12.1 General

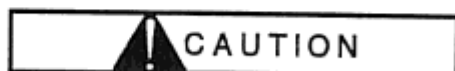

To avoid damage to your vessel, do not use lye based clog solvers in the fresh water, toilet, and/or the bilge pump systems.



Do not flush the toilet(s) when the holding tank is full, as shown by the illuminated red lamp on the "HOLDING TANK MONITOR", which is part of the salon d.c. panel. Continued flushing could severely damage the toilet system.

TOILET DISCHARGE WARNING

It is unlawful to discharge untreated sewage within the territorial waters of the United States. Violations are subject to a fine of \$5000.00 per incident.

NOTES:

Federal law prohibits the discharge of improperly treated sewage into the territorial waters of the United States.

Additionally, some areas may be declared NO-DISCHARGE areas.

State and local laws make it important to check with the local authorities about using a treated waste disposal system.

Marine toilets on vessels operating within U.S. territorial waters shall discharge directly into a holding tank which is to be emptied by a dockside pump-out facility or at sea beyond the U.S. territorial limits. To satisfy U.S. regulations, all outlet seacocks on vessels operating within U.S. territorial waters must be locked shut with a padlock, a non-releasable wire-tie, or have the valve handle removed.

For vessels operating outside U.S. territorial waters, it is acceptable to have a toilet system where the waste is either discharged into a holding tank and then pumped overboard or where the toilet discharges directly overboard through a discharge seacock.

Each toilet (head) in your Bertram is a complete Marine Sanitation Device (M.S.D.) and complies in all respects with the U.S. Coast Guard regulations and standards. The term M.S.D. means that this is a complete marine disposal system and includes the following hardware:

- the toilet and its associated plumbing;
- the flush timer;
- the pump;
- the holding tank equipped with a manual (or optional electrical) pump;
- the seawater supply seacock and discharge seacock;
- the deck mounted dockside pump-out fitting; and,
- a holding tank monitor.

In this marine toilet system, a switch in each head controls a dual-operation, electric, toilet-pump. This pump simultaneously pumps up the raw seawater for flushing and removes the waste from the toilet and either pumps it into the holding tank or overboard, as selected by the position of the toilet discharge valves.

12.2 Toilet System Operation

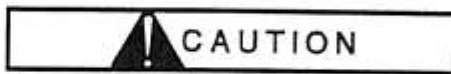

Do not flush non-soluble items or materials such as cigarette butts, sanitary napkins, or paper towels. They will clog the system.

To avoid damaging the toilet pump impeller, do not flush a toilet unless there is water in the toilet bowl. Do not pump bowl completely dry.

The position of the toilet discharge control "Y" valve, "Holding tank" or "Overboard", determines if the waste will be pumped into the holding tank or directly overboard. Do not confuse the discharge valve with the intake and discharge seacocks.

NOTE:

If both the overboard and holding tank seacocks are closed at the same time while the toilet is operating, damage to the system can result.

12.2.1 Inside U.S. Territorial Waters

For your marine toilet system to operate in U.S. Territorial waters in compliance with U.S. regulations, the following conditions must be met:

- The seawater inlet seacock which supplies seawater to the toilet system must be "OPEN".
- The overboard discharge seacock must be "CLOSED" and its handle secured or removed to prevent accidental overboard discharge of sewage.
- The toilet discharge "Y" valve must be set to "Holding Tank" to direct the flow of waste materials into the holding tank.

12.2.2 Outside U.S. Territorial Waters

For your marine toilet system to function without using the holding tank, outside U.S. territorial waters:

- The discharge "Y" valve must be set to direct the flow of waste materials directly overboard. The "Y" valve is set to the "Overboard" position.
- The discharge seacock must be "OPEN".

12.3 Flushing

On each toilet is a lever for flushing the toilet. Simply press the lever; the toilet functions automatically. An electronic timer will operate the flushing pump for a preset time.

12.4 Holding Tank Monitor & Pump-out

The "HOLDING TANK MONITOR" system is part of the salon d.c. distribution panel. The two panel lights with the captions "Caution" & "Full Tank" and the explanations are self explanatory.

The "Push To Test" & "Push To Silence" buttons will test the system and silence the monitor horn until the tank is emptied. The monitor system can be totally disabled by turning "off" the circuit breaker on the salon d.c. panel.

The gray water tank monitor system is also part of holding tank monitor system and is tested and silenced by the same push buttons.

NOTE:

It is important to empty the holding tank before it is full. If operation of the system is continued after the tank is full, the tank and/or the associated plumbing could burst open into the bilge because of the pressure exerted on the system by the toilet discharge pump.

There are three ways to empty your Bertram's holding tank:

1. Use dockside facilities (suction pump) to pump out the tank through the deck-plate. Removing the cover of this deck-plate allows direct access to the holding tank.
2. Use the electric overboard pump.
 - On the salon d.c. distribution panel, set the "**HOLDING TANK PUMP**" circuit breaker, "**ON**".
 - Open the overboard discharge seacock.
 - Under the forward cabin sole, adjacent to the holding tank is the **HOLDING TANK DISCHARGE PUMP** push-button switch. Depress this switch and hold it to activate the **HOLDING TANK DISCHARGE PUMP** motor.
 - When the holding tank is empty, the sound made by the **HOLDING TANK DISCHARGE PUMP** running free will change in tone and you should release the switch.
3. If your Bertram is not equipped with the optional electric overboard pump, you can empty the holding tank overboard using the standard manual pump located near the holding tank under the cabin sole.

13. Fresh Water System, Sump Pump & Monitor

13.1 General

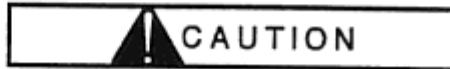

To avoid damage to your vessel, do not use lye based clog solvers in the fresh water, the toilet, and/or the bilge pump systems.

The fresh water system on your Bertram consists of:

- an expansion tank to reduce water knock,
- a low noise, high-output, water-pump with pressure switch; and,
- a water tank with liquid level sender & gauge.

13.2 Fresh Water Tank

The fresh water tank is located below decks. The tank is filled through a deck fill plate and vented through the hull side.

The water tank level gauge sender is inside the tank; the gauge with d.c. power switch is mounted on the salon d.c. or a.c. distribution panel.

NOTE:

You must fill the water tank using the deck fill system. You can not fill it using the dockside water supply quick-connect fitting.

13.3 Water Pump

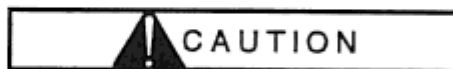

The fresh water system circuit breaker must be turned "OFF" when the tank is empty.

For day-to-day operation, your vessel's water pump is automatic, and normally needs no priming, except before its initial use or if the fresh water tank is pumped dry.

The pump holds an average static pressure of 30 psig. When the pressure drops below approx. 21 psig, the pump automatically turns "ON" and raises the pressure. If the pressure continues to drop because of no electricity or a dry water tank, the low pressure cutout (dry tank switch) will shut the pump off.

TO PRIME YOUR WATER PUMP:

- Ensure that the tank is at least partially full;
- open one faucet to release the trapped air;
- start the pump by lifting the "ON/OFF" switch on the pump lightly, until the pump starts, or momentarily hold "ON" the "RESTART" switch in the salon distribution panel;

Exception: The 60' Conv. does not have a switch on the salon distribution panel.

- then hold either the "ON/OFF" or "RESTART" switch "ON" until the system pressure reaches the pressure that the pump runs on its own; and,
- release the "ON/OFF" switch.

See the pump manual for maintenance.

13.4 Water Heater



Turn a.c. power "OFF" before removing heater access panels. Do not remove thermostat protective covers.

To avoid burning out the heater element, do not turn "ON" the water heater if the water level is below the heater element. Open a hot water tap until water stops spurting to bleed air from hot water system, then turn heater "ON".

This water heater can be damaged (the heating elements burned out) if operated without water or if the water level gets below the height of the heating elements.

The automatic water heater is located in the engine room. The thermostat on this heater is preset by the manufacturer at 140^o to 145^o F, which Bertram recommends as maximum.

The water heater operates on 240V a.c. which is supplied either by the a.c. generator or by shore power.

13.5 Showers

The shower has the customary mixing controls for adjusting the water temperature and a hand held shower head equipped with a push-button cut-off that retains the water temperature setting. Shipboard showers can either conserve or waste fresh water depending on how they are used.

13.6 Gray Water Tank (Shower Sump) & Pump

The gray water tank is located in the bilge below the cabin sole. This tank has a pump and an automatic float switch. The pump automatically discharges the shower water overboard and is connected to the d.c. power through the "GREY WATER PUMP" circuit breaker on the cabin d.c. distribution panel. This circuit breaker must be in the "ON" position if the showers and/or the air conditioning is being used since the fwd air conditioning condensate drains into the gray water tank and will cause the pump to operate even if the showers are not in use.

The gray water tank and pump should be regularly inspected and cleaned.

13.7 Gray Water Tank Monitor

The gray water tank liquid level is monitored by a monitor system with light, horn, and test and silent switches.

When the liquid level of the gray water tank reaches a nearly full condition, a red indicator will light and a horn will sound on the d.c. salon electrical panel. A momentary push switch is provided on that same panel to manually override the automatic operating function of the gray water pump. If holding the momentary switch "On" for a few minutes does not make the horn stop sounding and the light go out, momentarily press the silence button. The light will remain lit until the problem is corrected, but the horn will stop sounding. Correct the problem as soon as possible to prevent the gray water tank from overflowing.

The monitor system can be permanently disabled by turning "Off" the circuit breaker in the "D.C. Salon Panel". This monitor also includes the holding tank liquid level warning system. Turning "Off" the circuit breaker will disable the holding tank warning as well as the gray water tank warning.

13.8 Galley Sink And Lavatory Sinks



The galley and lavatory sink drains have built in water traps. Do not delete these traps.

The galley and lavatory sinks get cold water from the fresh water tank and hot water from the water heater. The lavatory sinks drains to the gray water tank. The galley sink drains overboard through a hull-side fitting.

13.9 Engine/generator Cooling Water

The engine room is equipped with a fresh water outlet fitted with a cutoff valve and hose to simplify the task of adding water to the closed fresh water cooling system on each main engine and generator.

13.10 Dockside Water Supply



When leaving vessel unattended, the dockside fresh water hose should be disconnected.

The dockside quick-disconnect fresh water hose connection is located in the cockpit. This is a convenient feature which allows you to use available fresh water from dockside to supply all the onboard fresh water requirements without using water from the fresh water tank. A pressure regulator in the supply line reduces the normal city water pressure to within the limits of the on-board system.

The fresh water tank can not be filled through this fitting.

14. Bilge Pump Systems

14.1 General



To avoid damage to your vessel, do not use lye based clog dissolvers in the fresh water, the toilet, and/or the bilge pump systems.

OIL DISCHARGE WARNING

The "Federal Water Pollution Control Act" prohibits the discharge of any oil or oily waste into or upon the navigable waters and contiguous zone of the United States. If such a discharge causes a film, or sheen upon, or a discoloration of the surface of the water, or causes a sludge or emulsion beneath the surface of the water, it is considered a violation of the regulation.

This applies to any overflow of oil as well as any bilge pump discharge.

Violators are subject to a penalty of \$5,000.00

Your Bertram has three (3) independent and separate bilge pump systems and one (1) bilge sump system. Each bilge pump system consists of a pump, manual/automatic control switch, and an associated automatic bilge pump switch. The fourth pump system, the "engine-room sump pump"; is always "ON", has no switch, and is always in the AUTOMATIC mode.

Exception: The 60' Conv. has a fwd bilge, sump pump in addition to the engine room bilge, sump pump.

14.2 Bilge Pump Locations

The submersible Forward bilge pump with its associated water level sensing switch are in the bilge under the forward cabin sole. The submersible midships bilge pump and associated water level sensing switch are in the engine room. The submersible aft bilge pump and associated water level sensing switch are near the transom in the aft bilge area. The "engine-room sump pump" is not submersible and with its associated water level sensing switch is in the keel sump between the two main engines.

14.3 Bilge Pump System Operation

Bertram intended that NONE of the three electric bilge pumps could be switched "OFF" from the flybridge control station console. The bilge pumps are connected directly to the batteries through fuses located on the "Main Supply Panel" and will function even with the battery disconnect switches in "OFF". The bilge pump control is wired so that the flybridge control panel switches can select between the manual (MAN, running constantly) mode or the automatic (AUTO, controlled by the bilge pump switch) mode.

Engine-compartment bilge water from the propeller shaft stuffing boxes is pumped overboard by the engine-room sump pump. The sump pump intake and its switch are in the engine-compartment sump.

The forward, midship, and aft bilge pumps are in the lower part of these bilges just below their bilge pump switches. This mounting arrangement assures that there will be a positive shut-down signal to the pump when the bilge is nearly dry.

14.4 Pump Maintenance

Each submersible pump has a strainer on the bottom of its intake. This intake must be kept clean and free of debris.

The engine room sump pump and the shower (gray water) sump pump have strainers in their suction lines. These strainers must be kept clean and free of debris.

For cleaning, follow the manufacturer's instructions in the data sheets included with your information packet.

14.5 Emergency Bilge Pump, Main Engine

Your Bertram's main engines have the capability to pump out the engine room bilge during an extreme emergency bilge flooding condition. This system should never be used or exercised (tested) except during an extreme emergency in which there is a danger of sinking. If the electric bilge pumps can keep up with the incoming water, do not use the emergency system.

To test only the emergency valve: With the engine stopped, move the emergency seawater ball valve to its full open position and then immediately return it to its completely closed position.

NOTE:

If your engines require d.c. electricity to operate, they will quit after the batteries are covered by salt water and the emergency bilge pump system will cease to operate. The electric bilge pumps will also quit at this time.

Maximum water flow is achieved at maximum engine R.P.M.. By regulating the engine speed, you may be able to hold the water in the bilge at a constant level to allow temporary repairs.

Repair the damage that is allowing the water to come into the boat as soon as possible, without endangering yourself or others. See "**Recommendations For Staying Afloat**" in the "General Information" chapter for additional information on this subject.

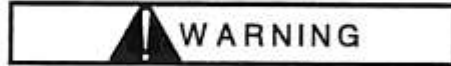

You, the operator of the vessel must be aware of the potential risk to persons aboard the vessel, the main engines and to the vessel when using this emergency pumping system.



There is extreme danger of fire and electrocution if water is flooding or spraying electrical equipment.

Stop the a.c. generator(s) immediately to lessen the danger of electrical shock or fire.

System Operation: If your main engine seawater intake system is equipped with an emergency system, read the following information carefully, and understand the serious consequences of system misuse.

At engine idle, open the emergency seawater ball valve completely. Then, close the engine seawater intake valve. Increase the engine speed until the water level in the bilge drops to a safe level but not below the emergency water intake scoop. Make temporary repairs to stop the flooding.

If the emergency bilge pump system can lower the bilge water, try to temporarily control the water level by one of the following suggestions:

- 1) Decrease the engine speed until a balance is achieved between incoming water and the amount of water being pumped overboard by the engine(s) and bilge pumps; or,
- 2) Slowly open the engine seawater intake valve until the bilge water level ceases to drop. If the engine seawater intake valve is fully opened and the water level continues to drop, slowly close the emergency seawater ball valve until the water level ceases to drop.



**The engine emergency ball valve must be fully opened before the engine seawater intake valve is fully closed.
Never shut down the engine(s) with both valves open.**

If the main engine seawater intake and emergency ball valves are not operated correctly, the engine impeller may suck air and either stop pumping the bilge water effectively, or overheat the main engine and exhaust system. This could ruin the engine and/or cause an engine exhaust hose fire. The boat could then take on additional water through the exhaust system.

A full flow of water must be present at all times. Do not allow the engine emergency bilge pump system to pump the bilge dry or operate with intermittent water flow, or an engine and exhaust system overheating condition will occur.

If both valves are left open when the engine is shut down. Water could be siphoned through the engine seawater intake and into the bilge through the emergency bilge pump system. The boat could quickly sink because of the size of the openings.

Bilge debris can be sucked into the engine. This will cause serious damage to the heat exchanger and engine raw water system in general.

The engine impeller can be damaged in a few seconds by bilge debris or lack of water. Lack of water can be caused by debris in the sea strainer, or trying to switch the intake system to emergency or back to normal without a full flow of water present at all times. Do not operate the engine with a damaged seawater impeller or an engine and exhaust system overheating condition will occur.

The engine monitor system will not function properly if water is spraying about the engine room or flooding the batteries. You may have no warning of engine or exhaust system overheat problems .

Never leave the emergency system operating without constant and proper supervision, unless personal safety is at risk.

15. Ventilation Systems

15.1 Ventilation Systems

15.1.1 General

Your Bertram has both natural air and forced air ventilation systems. Natural air ventilation for the staterooms uses the foredeck hatch to bring in fresh air. Natural air is delivered to and heated air removed from the engine room via the hullside engine-compartment vents on both sides of the hull. These vents are equipped with built-in water traps.

15.2 Engine Compartment Ventilation

The natural ventilation system for your Bertram is designed so that when your vessel moves, fresh air is taken in through the hullside vents and is ducted down to the engine-compartment. From there, the heated air is vented to the hullside exhaust vents.

To supplement the engine-compartment natural air ventilation, there is also a thermostatically controlled forced air ventilation system. The engine-compartment blowers discharge their heated air through the hullside exhaust vents.

The electric power, for these blowers, is connected to the blower circuit through a circuit breaker on the salon distribution panel. When the blowers are in their normal operating mode and the circuit breaker is in the "ON" position, the blowers are automatically switched by a thermostat in engine room. When the engine room temperature reaches approximately 110°F, the blowers are switched "ON", and they are automatically switched "OFF" when that temperature drops below approximately 90°F. The blowers have a manual override switch position, on the thermostat, which allows you to operate them regardless of the engine room temperature.

15.3 Stateroom Ventilation

The foredeck hatch can be opened either partially or completely to bring fresh air into the forward stateroom area. This hatch is hinged at its rear and has two pairs of locking dogs, one set at the forward edge of the hatch and the other set midway from the forward edge to the hinge. Both sets of locking dogs are operated from inside the forward stateroom and both sets can be locked shut to secure this hatch. The second pair of dogs is for added security and to ensure a water tight seal when this hatch is secured.

In addition to being a source of fresh air, this hatch also serves as a means of exiting the stateroom area if necessary.

15.4 Toilet (Head) and Shower Ventilation

Each head has a dc exhaust blower which is activated by a bulkhead mounted "ON-OFF" switch. The exhaust blower keeps down the humidity level by drawing off the moist air from the shower, out of the head area, and exhausting it overboard. The exhaust blower is controlled by a circuit breaker on the salon dc distribution panel.

15.5 Galley Ventilation

The galley area is ventilated by a 120 Vac powered fan on the same circuit breaker as the galley 120 Vac outlet .

16. Systems & Accessories

16.1 General

Your Bertram is equipped with several accessory systems, not previously described, that are designed to improve your boating pleasure. Systems descriptions and system operational details are discussed in their respective subsections.

16.2 Telephone System

Your Bertram is equipped with standard telephone jacks. The inlet for the telephone line is in the cockpit along with the electrical and CATV connections.

16.3 Seawater Washdown System

16.3.1 Description

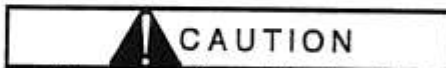

Seawater faucet(s) should be clearly labeled to prevent the accidental use of seawater for drinking or cooking.

Do not use this system as a fire pump for electrical fires because of the potential for shock hazard and short circuit

NOTE:

This system should always be switched "OFF" when your vessel is left unattended.

The basic seawater washdown system is a standard convenience feature built into this vessel and designed to accommodate a fisherman's needs. Your seawater washdown system will make the cleaning of fish, the fish boxes, the bait wells, and the cockpit area while at sea both easier and neater as well as aerating the optional live baitwell(s) and/or washing off the anchor.

The Seawater Supply and Washdown System (optional) system consists of:

- a through hull fitting equipped with an intake strainer;
- a seacock;
- a strainer;
- a seawater pump; and,
- seawater deck outlet.

In addition to the seawater washdown basic system there is one other optional arrangement available which is the seawater plumbing to a live baitwell in the cockpit preparation center.

16.3.2 Seawater Washdown System Operation

The seawater washdown pump is powered by the a.c. system. Therefore, shore power or generator power is required. The washdown system is activated by a switch located in the engine room entry.

Bertram recommends that the seawater pump be switched "OFF" except when in use. However, a relief valve and an overboard discharge through-hull fitting are provided to relieve the pressure on the system when the faucets are closed.

16.4 Windlass (optional)

16.4.1 General

If you have ordered the optional pulpit, a windlass either with or without the wildcat feature becomes yet another possible option. A windlass is intended only to lift up your anchor, it is not built or intended to be a mooring bitt and only in an emergency should it be used to drag a grounded vessel into deep water.

16.4.2 Operation

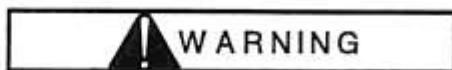

Exercise extreme care when working with a windlass, especially one equipped with a wildcat. This device has the capability of inflicting severe injury.



To avoid possible accidental operation, the windlass d.c. battery disconnect switch or a.c. circuit breaker, whichever is applicable, must always be in "OFF" except when the windlass is in use.

NOTES:

If your windlass has a wildcat, the fit of the chain links to the wildcat is critical. The chain should not jam, skip, or jump.

The capstan head is keyed directly to the windlass motor shaft and will revolve whenever the windlass motor is activated.

To raise an anchor line:

- Turn "ON" the windlass power. 1) Main power on the "Main Supply Panel" and 2) Switch power on the "D.C. Distribution Panel";
- if you have chain at the end of your anchor line, set the chain latch;
- wrap three (3) to four (4) turns of the anchor line around the capstan in a CLOCKWISE direction;
- keep a small amount of pressure on the line; and,
- step on the foot switch to activate the windlass.

If the line slips, take another turn and/or apply more pressure to the line. The wildcat is used to pull anchor chain, is driven by a friction system, and is not keyed to the main shaft.

16.5 Cablemaster Shore Cord Retractor

The Cablemaster is an a.c. shore cord retrieval system designed to eliminate the necessity to manually move 50 ft. of shore cord around the cockpit and dock.

The retrieval system is motorized by the d.c. system and is protected by a circuit breaker on the d.c. salon panel. The operating switch for the unit is located in the shore cord plug fiberglass recess.

See the Glendinning Cablemaster Manual for complete operating and service instructions.

NOTE:

The Cablemaster d.c. power circuit breaker should be turned off after the shore cord cable is set. This will prevent unauthorized operation of the unit.

16.6 Central Vacuum System



To avoid electric shock, do not use on wet surfaces or pick up water or damp materials.

FIRE DANGER:

**Do not pick up hot ashes, cigarette butts, or flammable powders.
Do not operate near flammable gases or liquids.**

To avoid possible injury, do not change the bag when the hose is connected.

Your Bertram has a central vacuum system built into the boat. Your system's accessories will allow you to reach all the living areas. However, the system is *not* a wet vacuum system. It is not designed or intended for use in the bilges or engine room.

16.6.1 Operation

Your vacuum system is powered by 120V ac. It is automatically switched **ON** when you plug the hose into the hose receptacle, and is automatically switched **OFF** when you remove the hose. You can connect or disconnect the system accessories (hose, extension wands, and vacuum heads) with a slight twisting motion.

The vacuum system is manufactured by Wal-Vac, Inc., 318 Mart St. SW, Grand Rapids, Mich. 49508. It uses easily replaceable dust bags that are available from Bertram or from the manufacturer in packages of five. These carry Bertram part number 181433 and Wal-Vac part number 54062 (Bag, Disposable).

You should wash the secondary filter with a mild detergent as required and replace it when worn or torn. It carries Wal-Vac part number 54230 (Filter, Secondary).

For more specific information on operating the vacuum system, see separate Wal-Vac operator's manual provided with your vessel's documentation.

16.7 Swimming Platform



Do not allow anyone to use the swimming platform while the engines are operating. The spinning propellers will cause serious injury.



CARBON MONOXIDE POISONING DANGER: Do not allow anyone to occupy the swimming platform while the engines or generator are operating.

The swimming platform should be occupied and used only while the vessel is stopped with the engines and generator off.

Propellers are dangerous to swimmers and divers. Do not allow anyone to use the platform while the engines are operating. Propellers may revolve very slowly, even if the gear is in neutral.

If the engines or generator are operating, there is a possibility of carbon monoxide poisoning if anyone is on the platform.

16.8 Searchlight (Optional)



FIRE HAZARD: Do not operate the searchlight with the cover on.

If the searchlight is operated with the cover in place, it may catch fire due to the extreme heat generated by the bulb.

16.9 Navigation And Running Lights

Your Bertram is delivered to you with a complete set of navigation/running lights installed. These lights fully comply with the requirements of the International Regulations for Preventing Collisions At Sea, 1972 (72 COLREGS). All vessels may use the 72 COLREGS as the controlling document when in international waters. For U.S. navigable waters, reference must be made to the Great Lakes and Western Rivers Rules.

The 72 COLREGS require that the navigation (running) lights shall be switched "ON" if your vessel is being operated between sunset and sunrise. For a vessel of this size, the required navigation lights consists of a red (for port) and a green (for starboard) sidelights, a white masthead(bow) light, and a white stern light, or if you are not docked nor anchored in a recognized anchorage, a white anchor light.

NOTES:

If your Bertram has a transom door, this door must be kept closed while underway at night to avoid obscuring the stern light. (This door should be kept shut at all times when underway to minimize the possibility of someone falling overboard.)

All of the navigation lights furnished on your Bertram meet the current 72 COLREGS requirements. However, it is the legal responsibility of the vessel's owner to:

Ensure that in the event of modification(s) to the the vessel superstructure (i.e., the addition of a fishing tower, radar, and/or other electronic equipment), that the required areas of visibility for each of these lights is not obstructed.

Ensure that his vessel complies with any future changes to the existing 72 COLREGS.

16.10 Docking Lights Switches (optional)

A switch is provided to switch "ON" or "OFF" the optional forward (FWD) docking lights and another for the optional aft (AFT) docking lights.

NOTE:

These lights are only to be used for docking. When underway, only your navigation lights may be showing. The Rules state: That from sunset to sunrise no other lights shall be exhibited that might be mistaken for the lights specified in the Rules, impair the visibility or distinctive character of the navigation lights, or interfere with maintaining a proper lookout.

16.11 Overhead Rod Locker

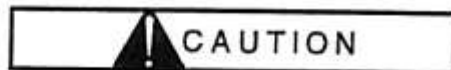

Do not mount equipment on top of the door. Additional weight may cause inadvertent opening of the door.

Do not mount rods and/or any other equipment on the top of the overhead rod locker door. Neither the hinges nor the latches are designed to take additional weight. If the door is loaded with gear and the latches fail, the door will swing down unexpectedly and could cause injury.

To adjust the tension on the overhead rod locker door latches, turn the nut on the inside of the latch clockwise to add or counter-clockwise to remove tension.

16.12 Steering Control System

Maneuvering by shifting gears is for docking and similar minimum speed maneuvers; but to maneuver at normal cruising speeds your Bertram is equipped with a positive-control, no-kickback, closed and pressurized-hydraulic steering-system moving twin balanced rudders. The rudders are at the stern and the main control station is fwd of midships, so steering feel is somewhat different from a car where the steering action takes place up front; although the results are essentially the same. However, in a vessel, the stern pivots out around a point somewhat forward of amidships. The steering system consists of:

- the axial, piston steering station pump;
- the relief valve with filters;
- the two double-action slave or steering cylinders; and,
- the reservoir with a sight glass, the system fill location, and the system pressure gauge.

NOTE:

The technical specifications for your steering system are summarized in the steering system specifications manual.

When you turn the helm (steering wheel), the axial piston pump pumps hydraulic fluid into either side of the single action, unbalanced, steering cylinders attached to the starboard rudder arm. The piston pushes or pulls the starboard rudder away from amidships. The rudders are tied together with a tie rod.

From the steering cylinders, the hydraulic fluid is piped to the relief valve. The relief valve is equipped with the system purging valves and filters. From the relief valve the hydraulic fluid is piped to the system reservoir. The reservoir has the system pressure gauge and the air and hydraulic fluid intake ports.

This steering system is designed and built specifically for marine use and is also designed specifically to prevent any outside air from entering into the reservoir. If needed, the steering system's air pressure can be recharged by using an ordinary bicycle pump attached to the valve on top of the reservoir. This reservoir is located in the lazarette and has a sight glass to allow you to check its fluid level.

See the steering system manual for detailed information on filling and purging your hydraulic steering system.

16.13 The Trim Tab Controls



Before running an inlet or if before a following sea, move trim tabs to full up to reduce the risk of broaching or pitchpoling.

NOTE:

Do not depress one switch "BOW DOWN" and the other "BOW UP" or hold either switch in "BOW UP" or "BOW DOWN" for an extended period as this will trip the circuit breaker which must be manually reset to "ON" to reactivate the trim tab system.

NOTE:

Except in an emergency situation, never go into reverse or back down quickly from any speed above idle while either or both of your trim tabs are in any position except the full up position. If you do reverse or back down suddenly, it is possible that the reverse pressure of the water pushing against the trim tabs could damage the trim tab, hydraulic cylinders, and/or the cylinder's internal seals.

NOTE:

Always return both trim tabs to the full up position by depressing and holding the BOW UP rocker switches prior to trolling, just in case it is necessary to "back down" on a fish. Again, this is to prevent damage to the trim tab, hydraulic cylinders, and/or the cylinder's internal seals.

NOTE:

You should check on your trim each time you make a significant speed change. Normally, the faster you are going, the less trim tab is required to maintain the desired trim. Additionally, too much bow down trim at any speed will reduce your speed and may also degrade the handling characteristics of your vessel.

Always raise both trim tabs to the full up position prior to docking. Following this recommendation helps prevent marine growth from developing on the exposed hydraulic rams.

After starting your engines, always check that you are leaving dockside (or anchor) with both trim tabs in the full up position. Once underway and clear of the harbor, as the sea conditions permit, you will want to put your Bertram on plane. If you want to use your trim tabs to adjust your trim angle, lightly depress the "**BOW DOWN**" switches to slightly lower your bow. Continue to depress and release the "**BOW DOWN**" switches to gradually lower your bow until you are at the optimum 5-degree bow up attitude. Your speed and the sea conditions will determine the extent to which you will want to lower the trim tabs to adjust your trim.

Your trim tab system is electro-hydraulic and is powered from the d.c. salon or flybridge electrical panel. The two trim tabs (one on each side of the hull at the transom) can adjust your Bertram's underway trim in almost the same way that flaps help an aircraft maintain the proper flight attitude. Trim tabs can also adjust port-to-starboard list when in adverse seas or with unusual load conditions.

You operate each trim tab with a rocker-type switch mounted on a panel on the flybridge control console starboard side below the throttles. The top of each trim tab rocker-switch is marked "**BOW DOWN**".

Depressing a trim tab rocker switch "**BOW UP**" causes its two hydraulic cylinders to pull in raising the trim tab up to its top position. Up is the normal operating position and the best for most cruising conditions and speeds.

Conversely, depressing the trim tab switch "**BOW DOWN**", extends both hydraulic cylinders pushing the trim tab down. Holding a switch "**BOW DOWN**", lowers the trim tab to its maximum down position. Under some sea and operating conditions, some "**BOW DOWN**" trim tab can adjust your vessel's trim to a smoother riding, more fuel efficient angle.

While underway, you may find that your vessel lists to port or starboard. This is usually due to the improper loading of gear and/or passengers or a beam wind. Your Bertram can be leveled by changing the relative positions of the port and starboard trim tabs.

16.14 Trim Tab Maintenance

See the trim tab manufacturer's manual.

17. General Maintenance

17.1 Battery Care

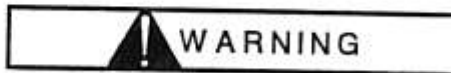

Gases escaping from any charging lead acid battery are an explosive mixture of hydrogen and oxygen. This mixture will explode with great violence and cause spraying of battery acid if a spark or open flame gets too close.

17.1.1 Distilled Water

The first choice for adding liquid to the electrolyte is distilled water. If distilled water is not available, a good grade of potable (drinking) water can be used if this water is free of minerals, particularly iron. Adding water to a cell will temporarily lower the specific gravity of the electrolyte in that cell. However, this does not mean that the cell has lost any of its charge.

17.1.2 Filling Procedure



1. Do not overfill battery cells. Excessive liquid will cause acid to spill out the vents when the battery is charging which causes corrosion at the terminals and the battery cables.

2. Never add acid to battery.

- Inspect each cell;
- fill each cell with distilled water, when required (the top of the plate separators should never be exposed); and,
- fill until the liquid level is about 3/8 of an inch above the top of the separators.

17.1.3 Excessive Loss of Liquid

Under proper operating conditions, your batteries should require only a slight amount of distilled water every few weeks. If excessive water is required, this is frequently a sign that the battery is being overcharged and the engine alternators and converter should be checked. With age, the batteries will begin to consume more water and give the appearance of improper charging.

17.2 Battery Gases - Explosive Hazard



TO AVOID SPARKS

Do not disturb the battery connections while charging.

When working on battery terminals be sure that:

- a. the engines are not running;
- b. all d.c. loads have been turned off;
- c. the converters have been turned off;
- d. you are not wearing rings or metal watch bands; and,
- e. you use extreme caution to avoid having wrenches or other tools contact both terminals.

17.3 Spilled Battery Acids

If battery acid is spilled, the following immediate actions are required to check or eliminate its damaging effects.

Acid splashed in the eye:

- should be washed out immediately and continuously with plenty of cold, fresh water for at least twenty (20) minutes.
- If cold, fresh water is not available, use milk or any available fresh water based potable liquid to dilute the acid.
- always see a doctor as soon as possible.

Acid splashed on other parts of the body, the clothing, or parts of your vessel must be:

- removed immediately by washing thoroughly with cold water; and,
- the area neutralized with a solution of baking soda or household ammonia in water.

If a considerable amount of acid is spilled from the battery, the battery should be replaced.

17.4 Diesel Fuel



Never add commercially marketed diesohol or gasohol to diesel fuel. This mixture creates both explosive and fire hazards.

Use only high quality Diesel fuel that meets the engine manufacturer's specifications. See their manual for details. Small amounts of isopropyl alcohol (isopropanol) may be used to prevent fuel line freeze-up in winter months. No more than one (1) pint of isopropyl alcohol should or need be added to each 125 gallons of Diesel fuel for adequate protection.

17.5 Electrical Repairs



Before opening any a.c. or d.c. distribution panel or servicing any electrical equipment:

- 1) **Disconnect shore power cord and**
- 2) **Stop the generator.**
- 3) **Turn off the main battery disconnect switches.**

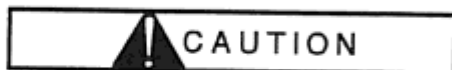

Do not replace your vessel's circuit breakers or fuses with breakers or fuses of higher amperage ratings than those installed by Bertram. Select breakers and fuses for the spare circuits on the dc and ac distribution panels with ratings that match the load but doesn't exceed the current carrying capacity of the wires in each branch circuit.

Bertram recommends that electrical maintenance be performed by a qualified marine electrician. The a.c. circuits can deliver a lethal shock. Also if repairs or modifications are done incorrectly, there is the danger of an electrical fire.

Wiring diagrams for your Bertram are included with this manual.

17.6 Cockpit Hatch Dog Adjustment

Hatch dogs on the cockpit hatches require adjustment to eliminate seepage. To avoid over compressing the gaskets, these dogs should NOT be over tightened. Turn the nut on the under side of the hatch dogs to adjust the fitting tightness. Where possible, someone must be in the compartment below the hatch when you test for seepage.

- Lift and turn the hatch dogs 1/4 turn to release the hatch.
- Loosen the upper "jam" nut on the bottom of each hatch fitting so that you can tighten the lower "locking" nut until the hatch is "snug" against the gasket all the way around.
- After all cockpit hatch dogs are adjusted, use a flashlight to check for seepage after water is poured over the hatches and surrounding deck.

17.7 Nonfiberglass Plastics

17.7.1 General

Besides the Fiberglass Reinforced Plastic (FRP) better known as fiberglass, your Bertram has both acrylic and Acrylonitrile Butadiene Styrene (ABS) parts. These parts are light weight and are very strong. However, they are relatively soft and their surfaces can easily be scratched by improper cleaning. The scrubbing that may be necessary to clean a badly soiled fiberglass deck or hull surface should never be used to clean these parts.

When installing or reinstalling an acrylic or ABS part that is fastened with screws, do not use a power screwdriver to run the screws all the way down. Make the last few turns by hand to avoid overtightening and stress cracking the part.

17.7.2 Acrylic



Do not use solvents such as lacquer thinner, acetone, mineral spirits, nor abrasive cleaners for cleaning acrylic parts. Do use mild detergent in warm water and 100% natural (cotton) cloths or a commercial plastic cleaner such as "Novus" Number 1 Plastic Polish. Use "Novus" Number 2 Plastic Polish as directed to remove fine scratches.

Among other uses, clear acrylic plastic is used as the spray and weather protective covers for the instrument and switch panels on your flybridge control console. Acrylic plastics are much tougher than glass and are resistant to stains, sea spray, and sunlight. However, they are readily scratched by hard objects, grit, or abrasives such as scouring powders and they are readily attacked by solvents such as acetone, mineral spirits and lacquer thinner.

To clean acrylic plastic, use a prepared commercial cleaner such as "Novus" plastic polish number 1 or a solution of a mild detergent such as "Formula 407" or "Fantastic" in warm water with a soft, 100% cotton cloth.

17.7.3 ABS Plastics.

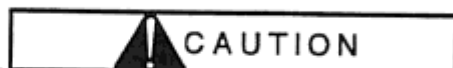

Do not use solvents such as lacquer thinner, acetone, mineral spirits, nor an abrasive cleaner for cleaning ABS plastic parts. Do use a mild detergent in warm water and 100% natural (cotton) cloths on painted ABS surfaces and a commercial liquid cleaner such as "Armorall" on unpainted ABS surfaces.

Bertram uses both painted and unpainted ABS plastic parts on your vessel.

Unpainted ABS can be cleaned with a commercial plastics cleaner such as "Armorall" cleaner. Painted ABS looks very much like fiberglass but must not be scrubbed. Painted ABS should be cleaned with a solution of mild detergent such as "Formula 407" or "Fantastic" in water using a soft sponge or a soft all cotton cloth.

17.8 Oil or Fuel-Soaked Rags & Wipes

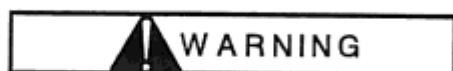

Oily or Fuel-soaked rags and wipes may be subject to spontaneous combustion. Do not keep used rags and wipes in the engine compartment. They should be stored in a fire-resistant container specifically intended for such storage.

17.9 Crevice Corrosion

When your vessel is in wet storage, rotate both propeller shafts about once a week to prevent crevice corrosion, which may occur in the area of the struts and shaft logs if the shafts stay in the water in the same position over a long period.

17.10 Galvanic Corrosion

If your vessel is idle for extended periods, Bertram suggests that a zinc "fish" be hung over the side in the water on a heavy wire, with a clip at the other end of this wire attached to your vessel's galvanic bonding system.

The use of a zinc "fish" will help control the galvanic corrosion affecting components mounted through the hull below the waterline.

When a zinc has greatly disintegrated, you should replace it, as it will no longer be effective. You can purchase zinc "fish" from a marine supply store, or make them from zinc blocks if desired. Remove the zinc from the water before making any attempt to move the boat under power. Replace standard transom zincs as required.

17.11 Galvanic & Stray Current Bonding (Grounding) System

As a part of the electrical system, your Bertram is equipped with a grounding system designed to minimize stray electrical currents and help control galvanic corrosion. The main grounding strap runs fore and aft through the bilge area. This main grounding strap is connected by jumpers to the underwater fittings and hardware as well as the engine blocks. All on-board a.c. equipment is connected by a grounding conductor (green wire) to this system. D.C. equipment that is mounted low in the bilge area is also connected by jumper (green wire) to this system.

Bertram does not connect fittings and d.c. equipment to the grounding system unless the items benefit from the connection.

18. Fiberglass Care

18.1 General

Proper care will help you keep this unique material in good condition.

18.2 Seasonal Care (at fitting out time)

- Clean the surface with soap and water.
- Treat with white automotive type polishing compound; use this polish lightly and follow the manufacturer's directions.
- Wax and polish the gel coat surface with a paste type of automobile wax.

NOTES:

- a) Some modern paste wax products provide both rubbing and waxing action in one. These products are acceptable.*
- b) Fiberglass repairs more extensive than those described here should be made only with the help and advice of your Bertram dealer.*

18.2.1 Loss of Gloss

To restore the glossy appearance of the gel coat surfaces, a light buffing may be advisable.

- For hand buffing, use a slightly abrasive rubbing compound similar to *DuPont Number 71*.
- If a power buffer is used, Bertram recommends that *MirrorGlaze Number 1* or a similar product be used.
- After buffing, the gel coat surface should be waxed and polished as described above for "Seasonal Care".

18.2.2 Stains

The fiberglass gel coat surface on your Bertram was chosen to retain its beauty and be highly resistant to most stains. Table 6-1, Recommended Stain Removers For Fiberglass lists the Bertram recommended stain removers. If none of the methods shown in Table 6-1 are successful, it may be necessary to sand down through the gel coat to remove the stain.

TABLE 6-1, RECOMMENDED STAIN REMOVERS FOR FIBER-GLASS	
STAIN	RECOMMENDED REMOVER
Common stains	Household detergent, diluted in water or full strength
Crayon, lipstick,	Alcohol & shoe polish
Ink spots	Ajax cleanser
Resistant stains	Ammonia cleaners or a weak solution of hydrochloric acid

18.2.3 Scratches & Abrasions

Those scratches and/or abrasions that do not penetrate the full thickness of the gel coat can usually be treated by lightly sanding and buffing the area. Larger scratches that do penetrate the gel coat but do not go deeply into the fiberglass or weaken the structure can also usually be repaired as follows:

- Clean the damaged area first with mineral spirits or turpentine to remove dirt and wax, then follow with a detergent and rinse, and allow to dry completely.
- Secure a small amount of pigmented gel coat resin whose color matches the color of the area to be repaired. This material should be available to you from your Bertram dealer.
- Add two drops of catalyst per cubic inch of gel coat and mix thoroughly; the mixture will harden in approximately 15 minutes.
- Fill the scratch with the mixture before the mixture hardens.
- Round the patch off to about 1/16 of an inch to 1/8 of an inch above the surrounding surface.

- Lay a piece of waxed paper or cellophane on top of the patch and press lightly to remove any trapped air. Take off the waxed paper after at least 20 minutes and allow the patch to cure overnight.
- Lightly sand the area with 600 grit wet sandpaper.
- Finish the patch by rubbing and buffing with a commercial buffing compound.

18.3 Painting Fiberglass Surfaces

- Thoroughly clean all of the dirt and grease from the fiberglass part to be painted with mineral spirits, turpentine, or other commercial solvents.
- Wash with a detergent and water solution and rinse.
- After the surface is dry, sand it lightly with garnet, fine oxide, wet and dry, or 220 sandpaper. Wipe the surface clean of all dust.
- Apply two thin coats of primer following the directions of the marine paint manufacturer.
- Apply the marine paint as recommended by the manufacturer.

18.4 Bottom Anti-fouling Paint

18.4.1 General

Bottom anti-fouling paints should only be applied per the manufacturer's instructions. Before repainting any vessel's bottom, a check should be made to ensure that the brand and type of paint chosen are fully compatible with the type presently on the vessel's bottom.

NOTE:

Some types of bottom paint are not compatible unless a primer is used first.

NOTE:

Do not paint zinc(s) and use only the manufacturer's recommended paint on depth sounder transducers.

18.4.2 Before Applying Anti-Fouling Paint

Preparation before applying any additional anti-fouling paint should include making sure the trim tab assemblies are covered (masked off), particularly the hydraulic cylinder piston rods. Take care to ensure that the lower portion of the cylinder where the ram comes out of the cylinder has been fully protected.

18.5 Bottom Blisters

Regardless of the quality of the materials used and of the care taken in construction, bottom blisters may occur on any fiberglass hull. If you do observe bottom blisters, Bertram suggests that you contact the Bertram Service Department before you attempt any repairs.

19. General Subjects

19.0.1 General

The information contained in this section is important and in some cases could be life saving. Please read carefully.

19.1 Hull Efficiency

Your Bertram is designed to carry comparatively heavy loads without appreciably reducing performance; however, for the best performance results you should maintain original trim. This is with a slight (about 5 degrees) bow up attitude. Therefore, Bertram suggests that you spend at least a few minutes to become familiar with how the vessel behaves at this trim and to just get the feel of your vessel, especially the visual relationship of the bow to the horizon when she is first launched, and before any extra equipment is put on-board.

Of course, all gear and equipment on-board should be properly stored while cruising and you should be aware that all of the personal equipment and accessories placed on board will tend to decrease her speed as will adding weight in the form of passengers. Remember to take the effect of this added weight into consideration when calculating the performance of your vessel.

19.2 Atmospheric Conditions

There are some additional operational considerations for you to keep in mind while operating your Bertram; for instance, engine performance will be affected to a slight degree by local atmospheric conditions. Among other things, you will find that the engines develop slightly less power in warm air temperatures. Similarly, dry air reduces power, as will high altitudes. If you are cruising regularly in waters well above sea level, you will want to have a certified mechanic make the necessary adjustments to your engines to get the correct air/fuel mixture.

19.3 Marine Growth

To obtain the maximum hull efficiency, which directly translates into speed, the bottom of your Bertram must be kept free of marine growth, including grass. Any growth will increase water resistance, thus decreasing speed and fuel efficiency.

A planing hull will perform slightly better in salt water than in fresh water due to the difference in the weight of water that it displaces.

19.4 Water In The Bilge

The bilge should be kept pumped dry to minimize excess weight and sloshing. The added weight of bilge water causes the vessel to ride lower, increasing water resistance. This added drag in turn reduces your vessel's speed and lowers fuel efficiency. Your Bertram has cockpit scuppers that prevent water from accumulating in the cockpit by allowing it to flow overboard. The bilge is kept dry by a sump pump and three bilge pumps equipped with sensor switches.

19.5 Damaged Underwater Equipment

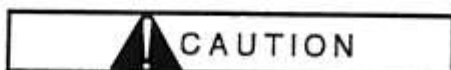

Only under Emergency Conditions should your Bertram be operated at cruising speed with a vibration caused by damaged propellers or running gear. Get a tow, or, if necessary, proceed with extreme caution at idle speed.

A significant loss of speed and excessive vibration can and usually does result from damaged propellers, shafts, struts, and/or misaligned rudders and engines. The rudders on your Bertram always should be kept parallel, neither "toed in" nor "toed out". The propeller shaft alignment should be checked periodically.

19.6 Draft

To avoid going aground or damaging your underwater gear in shallow waters, it is absolutely vital you know how much water your vessel draws (her draft). Be aware that any vessel's draft varies depending on her load. Bertram suggests that you determine her draft fully equipped and at or near the maximum load you expect her to be carrying. Remember, any vessel will draw slightly less in saltwater than she will equally loaded in fresh water. To determine her draft:

- Measure the freeboard (hull height above the water) from the covering board top to the waterline at the transom's center.
- Subtract this measurement from the dimension given for the distance between the covering board top (at the transom's center) to the bottom of the propeller. See the docking plan supplied with this manual to find your vessel's maximum draft at the transom.
- Record this dimension where it will be readily available, for instance on your compass deviation card.

19.7 Height

Besides knowing your vessel's draft, it is also vital you know her height including any optional equipment such as fishing towers and/or antennae for your electronic equipment. Take this measurement when she has the lightest possible load of fuel, passengers, and equipment. This measurement should also be recorded on your compass deviation card.

19.8 Compass



The compass aboard this boat is not compensated by Bertram Yacht. Compass compensation is the responsibility of the boat owner and it should be done by a competent compass technician.



Any time any electronic equipment, gauge, or instrument is added, removed, or replaced on the instrument panel or in its immediate area, compass deviation should be checked by a competent compass technician.

19.8.1 General

Your Bertram is equipped with a lighted, compensating type marine compass mounted on top of the instrument panel console.

This is a magnetic card compass and, like all magnetic compasses, it is affected by:

- nearby ferrous metal (iron and steel) objects including tools, some beverage cans, etc.;
- magnetic fields generated by nearby electrical or electronic equipment, including other compasses;
- variations in the earth's magnetic field.

Any time any electronic equipment, gauge, or instrument is added, removed, or replaced on or near the instrument panel, compass deviation should be checked by a competent compass technician.

The magnetic compass can be the most important navigation instrument on a boat. A compass is basically a permanent magnet, free to swing into alignment with the influence of existing magnetic fields. A typical marine magnetic compass consists of:

- one or more magnets;
- a calibrated card;
- a jeweled pivot;
- the compass bowl;
- a means of illumination for night use.

Except for the night navigation light, the marine magnetic compass installed on your vessel does not need electrical power to function, and therefore it is not disabled in case of shipboard electrical difficulties.

19.8.2 Compass Construction

The permanent magnet provides the magnetic field seeking element of the compass and is usually attached to the underside of the calibrated card. Additional magnets may be located inside the compass and are used for adjustments.

The card is a non-magnetic material marked with a scale calibrated from 000 deg. at North, then clockwise through 090 deg. (East), 180 deg. (South), 270 deg. (West), to 360 deg. (which is also 000 deg. and North). This card is centered on a jeweled pivot in the center of the compass card.

The bowl may be filled with a mixture of alcohol and water or light oil. The compass card is partially supported by the liquid, reducing the friction and damping out excessive motion.

The housing for your compass is called the binnacle. When mounted, the compass card magnet aligns with the strongest magnetic field, normally the earth's magnetic field (but the effect of this field can be modified by electrical and electronic equipment, machinery, other compasses, and other nearby magnetic materials). When a compass is properly adjusted (compensated), the compass card will align itself closely with the earth's magnetic field and point approximately toward magnetic north.

19.8.3 Compass Error

Compass error is the observed difference between an indicated compass bearing and the actual bearing relative to true north (based on the north star, Polaris).

All navigation at sea is plotted on charts which use true north as a reference. If you are doing any long distance cruising that could require you to work navigation plotting problems and plot compass courses, it is vital that you know two things:

- local variation (the difference in degrees east or west between true north and what your compass indicates as north (magnet north)) as shown on the local chart;
- your compass' deviation for a given heading.

To obtain your correct bearing from the vessel's compass, you must correct for these two compass errors.

Variation. Local variation is the angular difference between magnetic north and true north. Variation is expressed in degrees east or west of true north and is not affected by your vessel's heading. It ranges from zero to about 20 deg. east or west error, depending on your global location.

This variation in the world's magnetic field is shifting continuously and irregularly, so magnetic north moves slightly each year. You will find local variation readings printed on current navigation charts.

Deviation. Every compass is affected by objects in the immediate vicinity. Deviation is the angular difference between the reading your compass provides as installed and the reading it would provide if the objects were not there.

Deviation is caused by such shipboard influences as your engines, electric motors, instruments with meter movements, electronic equipment, speakers, and other objects placed near the compass.

Deviation is expressed in degrees east or west of true north. It varies with the heading of your vessel, because, as your vessel turns, the position of the objects that affect the compass change relative to magnetic north.

You must know and record deviation on the compass card placed on or near each compass. You must record the deviation for each individual compass you use, because the position of each compass relative to the materials around it determine the deviation.

Your marine compass is fitted with a set of compensation or adjustment screws to minimize these errors. It is seldom possible to compensate for all compass deviation errors since this type of error varies as the heading of your vessel varies. However, the error should remain the same for any given heading as long as no changes are made to the instruments and electronics on or near the instrument panel.

There is a vertical mark on the compass bowl called the "lubber line". This line was oriented when your compass was installed so an imaginary line drawn from the compass pivot point to the lubber's line will be parallel to the longitudinal axis of your vessel. Thus, your vessel's course (compass heading) is the compass card reading under the lubber's line.

19.9 Trip Preparation

To minimize problems and to get the maximum pleasure from your Bertram, we suggest that you go over a written checkoff list each time you use her. The following items should be part of this list.

BEFORE LEAVING DOCKSIDE CHECKOFF SHEET

- 1) Pump bilges as needed (check bilge pump operation).
- 2) Check lubrication oil levels.
 - a) PORT Engine.
 - b) PORT Transmission.
 - c) Generator(s).
 - d) STBD Engine.
 - e) STBD Transmission.
- 3) Check coolant levels.
 - a) PORT Engine.
 - b) Generator(s).
 - c) STBD Engine.
- 4) Check the fuel, coolant, and oil systems for leaks.
- 5) Check the seawater strainers, clean if necessary.
- 6) Check that all seacocks are open.
- 7) Check fuel and fresh water tank levels.
- 8) Check Diesel fuel/water separators, drain if needed.
- 9) Check the fluid level in all batteries.
- 10) Check the operation of the navigation and anchor lights.

- ___ 11) Check that there is one correct sized life jacket (PFD) for every one aboard.
- ___ 12) Check that the throwable Type IV PFD (life preserver) is on board and is in its mounting bracket.
- ___ 13) Check that current visual distress signals are on-board.
- ___ 14) Check that the portable fire extinguishers are on board, are usable, and are in their mounting brackets.
- ___ 15) Check that your first aid kit is on board.
- ___ 16) Check that the necessary charts are on board.
- ___ 17) Check that communications and navigation equipment works.
- ___ 18) Check the latest marine weather forecast.
- ___ 19) Test the monitor systems.
 - a) Fire
 - b) Bilge Flood
 - c) Gray Water Tank
 - d) Holding Tank
- ___ 20) Test the Fire Extinguisher System Monitor.

19.10 The Fishing Tower

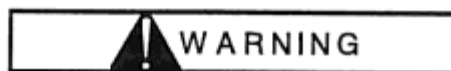

Do not occupy the fishing tower under adverse sea and/or wind conditions.

The height and weight of a fishing tower (also called a tuna or marlin tower), and that of any occupant(s) add significantly to your vessel's vertical center of gravity. This may result in excessive heeling and slower recovery to an upright condition and may make it difficult and/or dangerous to attempt to leave the tower if sea conditions worsen. Therefore, under adverse sea and/or weather conditions do not occupy this tower.

19.11 Propeller Hazard



To reduce the risk of serious injury, do not enter or leave the water from your vessel while the engines are running.

When swimming or working in the water near your vessel, remember that your propellers have sharp blades that can seriously hurt anyone who is pushed against them by a wave or the current, even if that propeller is not turning. To reduce the risk of death or serious injury from your props, you must shutdown both engines and ensure that both propellers have stopped turning before allowing anyone to:

- go out on the swim platform;
- enter or leave the water; or,
- board or disembark from your vessel by climbing out of or down into a dinghy.

19.12 When Underway

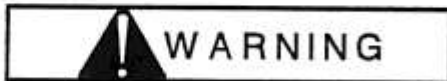

When underway, to reduce the chances of someone falling overboard, do not let anyone:

- Move to or from the foredeck along the outside of the cabin;
- Leave the transom door open; or,
- Move about topside without the proper non slip "boater" footwear.

As stated in the above warning, certain aspects of being on any moving vessel can be dangerous. However, these dangers can be reduced if you are the type of operator that exercises caution where required. For instance, moving forward on deck or moving about the foredeck when your vessel is underway should always be done cautiously. Always keeping the transom door shut when underway is another obvious precaution.

19.13 Preparations For Rough Weather



Keep deck hatches secured while underway to prevent engine room and lazarette flooding.

Some of the several compelling reasons for you to buy a Bertram may have been its long tradition of exceptional strength and its seaworthiness. However, never lose sight of the basic fact that there is no vessel, regardless of its size and strength, that is completely immune to the dangers of heavy weather. Therefore, when you preparing for heavy weather, or if you are running ahead of a heavy following sea, ensure that the cockpit hatches are tightly shut and dogged down to prevent flooding the below decks areas.

You should also be aware of the fact that in case of fog or other limited visibility, you are required by the law (Rules of the Road) to:

- **Slow Down.** If you are navigating in waters marked on your charts as falling under the Inland rules, you are required to slow to a "Moderate Speed" in accordance with the Inland Rules. Under the International Rules you must slow to a "Safe Speed". Admiralty courts have generally held that a "safe speed" is the maximum speed at which a vessel can come to a complete stop in one half (1/2) the existing visibility.
- Post at least one lookout (besides the helmsman) who's sole responsibility it is to watch for vessels and other hazards to navigation.
- Therefore, in anticipation of the inevitable rain, fog, high winds, and/or rough seas that you will eventually encounter, here are a list of preparations that you will want to take. This checklist is suggested as an agenda of things that you should do before a heavy weather situation gets out of control. You will undoubtedly have several of your own items to add to this list:

HEAVY WEATHER CHECK LIST

- ___ 1) Close and secure all hatches, doors, ports, and windows, and in particular, double check that all cockpit hatches are securely in place.

- ___ 2) Use the **MAN** (manual) bilge pump switch positions to ensure that all bilges are pumped dry. This should be repeated as often as seems necessary. Since "free" water sloshing in your bilges degrades your vessel's performance.

- ___ 3) Secure all loose gear. Stow all the smaller items and securely lash down all the larger ones.

- ___ 4) Break out the Personnel Flotation Devices (PFDs) (life jackets) and have everyone don and properly adjust one before the weather turns this chore into a real problem.

- ___ 5) Get the best fix possible on your current position and track and update the plot on your chart.

- ___ 6) Break out and keep handy what ever emergency gear you feel may be needed, such as flash lights, the first aid kit, a sea anchor, distress flares, etc.

- ___ 7) Plot (prepare) course changes to the nearest protected harbor or sheltered waters in case the storm worsens.

- ___ 8) Stay current with local marine weather reports, if possible, have one person assigned to monitor the marine weather channel(s).

- ___ 9) Any time there is reduced visibility, post at least one lookout whose sole responsibility it is to watch for other vessels or possible dangers.

- ___ 10) If at all possible, it is better to have all hands busy rather than sitting and worrying, therefore inform your crew and passenger of the following:
 - what you are doing; and,
 - what you want each of them to do or not to do.

19.14 The Beaufort Scale Of Wind Force

To more accurately and quickly transmit wind and wave information over the radio, the British "Royal Meteorological Office" developed a table (with comparison photographs) of each of the thirteen wind forces. Some of these photographs are in Chapman's text "Piloting", the basic text book for boaters.

19.15 Running Aground



When aground, do not attempt to drive this vessel off. Trying to refloat this vessel under its own power could result in damage to the propellers; propeller shafts; struts; and/or, the transmissions (clutch and reverse gears).

Do not run engines while aground; sand, dirt, and other foreign matter could be drawn into the cooling system and damage your engines.

If you are an active boater for an extended period of time, the odds are that sooner or later you will either run aground and/or hit a piece of floating debris (flotsam). If you do have either of these accidents, take the following steps to protect your vessel and to minimize the damage and take them in the order given below.

Resist the natural impulse to "throw" the transmission into reverse and instead, pull both throttles back to reduce the engine speed to idle or less than 1000 rpm.

- Then shift both clutches into neutral.
- If aground, stop both engines.

If you have struck a piece of flotsam:

- Scan the waters ahead and behind for additional flotsam to try to determine if it is safer to proceed or to try to back out of the danger area.
- Then leave the area at the slowest possible speed.

19.16 Recommendations For Refloating Vessel

Most vessels are run aground at the bow. Unless your vessel has received hull damage that requires repair before refloating, the most important thing is for you to avoid damaging your propulsion system, being holed, or being driven further ashore and for you to prevent possible damage from pounding or broaching.

Pounding. Pounding is when each wave raises a grounded vessel's hull and then drops against the sea bed. Bottom damage from pounding can range from cracking the fiberglass to opening serious holes in the hull. As each wave strikes against the vessel, the continuing wave action tends to drive the vessel harder aground.

Broaching. Broaching is the most serious problem a grounded vessel may face and occurs when the vessel is thrown or turned broadside to the shore or the shoal by the waves. Broaching is dangerous for two reasons. First, broaching continually drives a grounded vessel harder aground. Second, currents are set up around a grounded vessel's bow and stern. These currents tend to scour sand away from under the vessel's hull, piling this sand up amidships and to leeward of the vessel, eventually leaving the hull supported only amidships. This can break a vessel's back.

Staying Afloat. The following steps are suggested.

- The first step is to determine the location and extent of any hull damage. Bertram hulls are among the strongest made, but running any vessel up onto a sharp coral reef or a pointed rock can damage it.
- If necessary, make a patch using one or more of the two part, emergency, fast setting epoxy, hull patch kits, readily available at marine hardware stores. These patches can be applied to almost any hole from either inside or outside your Bertram as the situation requires. At least one of these kits should be a part of your emergency supplies. Otherwise, cram anything available into the hole to stop or at least cut down the water coming in.
- Call for a tow as soon as time permits.
- If you can remain afloat, you may wish to set one or more stern anchors as quickly as possible to prevent broaching or being driven farther aground.

- If a tow is not immediately available, you may have to wait for the next high tide. A lead (a weighted hand line marked in feet) can be very useful to check around a grounded vessel to determine where the deeper water is located.

19.17 Flotsam (floating Debris)

If you observe flotsam while at cruising speed, immediately throttle back to idle speed. Once at idle, shift into reverse or forward depending on the situation and proceed cautiously until out of the danger area.

19.18 Vibrations

Should you either run aground and refloat or strike a piece of flotsam, before you accelerate to cruising speed, proceed at a slow speed and check that there is no noticeable vibration which might indicate damage to your vessel's underwater gear. If a vibration is noticed, proceed to dockside at the reduced speed. Depending on the damage done, it might be necessary to shut down one engine.

19.19 Towing

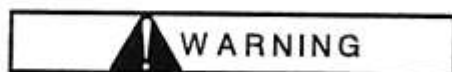

Do not secure tow lines to deck cleats, which are only for mooring. Cleats are not fastened to your vessel for towing. Rather, use a long line to form a towing bridle around her hull.

Take added care if towing or being towed with "Nylon" lines. These lines stretch and if a fitting fails or the line parts, the ends can snap back with sufficient force to injure.

19.19.1 General

Although a common courtesy between pleasure vessel skippers, towing is not recommended since it can be dangerous to the occupants of the towing and the towed vessels and is best left to professional salvors or those trained to minimize the risks. The U.S. Coast Guard Auxiliary manual CG 484 "Auxiliary Towing Guide" dated 1977 states that most marine accidents occurring during towing fall into one of the following three categories:

- 1. Most recreational type boats do not have suitable deck fittings for towing and many do not have suitable deck fittings to be towed;
- 2. The boating public in general has both a limited knowledge and practice of good seamanship; and,
- 3. Boating personnel sometimes failed to conform to good seamanship practices through inexperience and/or expediency.

19.19.2 Personnel Safety

In all towing operations the primary objective is to ensure the personnel safety on both vessels. Thus your first goal always is to save lives and to avoid inflicting personal injury. The saving of property is only secondary and must never take precedence over personal safety.

19.20 Use Of Personal Flotation Devices

By federal regulation and the laws in most states, this, or any other vessel, powered or not, is required to have one (1) U.S. Coast Guard approved Personal Flotation Device (PFD) of suitable size and readily available for each adult and each child on board (this device is commonly referred to as a life preserver or life jacket). If this vessel is not used commercially, PFDs may be Type I, II, or III. If this vessel is to be used commercially and will be carrying 6 or fewer passengers for hire (charter boat operation), the PFDs must be Type I.

For this vessel, Bertram furnishes, Type II buoyant vests, adult size (90 pounds or more). This type of PFD is capable of turning its wearer to a vertical or slightly backward position in the water. The Bertram supplied vests are high visibility orange and comply with all the U.S. Coast Guard requirements for a Type II device and carry the U.S. Coast Guard's approval label. Type II PFDs come in four sizes, adult (90 pounds plus); child medium (50 to 90 pounds); child small (30 to 50 pounds); and, child small (less than 30 pounds).

This type of PFD is donned by placing it over the head with the collar behind the neck. The waist strap should then be connected and adjusted to prevent this device from riding up on the wearer. The technique for donning PFDs should be practiced by everyone so that they know where to find them and how to properly don one even in the dark, try donning your PFD while wearing a blindfold. If time and conditions permit, for instance during a swim, all hands should also practice water entry and swimming while wearing a PFD

The recommended technique for water entry while wearing a PFD is to wrap both arms as tightly as possible around the wearer's chest, under the chin. This protects the face and keeps the PFD from riding up. Always jump into the water feet first, with both the feet and knees together and the knees slightly bent. The head should be tucked down into the pocket made by the folded arms. As soon as a wearer is in the water he should join others for mutual assistance and warmth.

Please keep in mind that Bertram furnishes only adult sized PFDs and that the U.S. Coast Guard requires that every one on board have the correct size PFD. Please keep in mind also that being put away wet and/or stored in a damp locker promotes mildew and hastens the deterioration of the PFDs. Rather they should be first thoroughly rinsed off in fresh water, then dried, and then they should be stored in a cool dry place out of direct sunlight. Storage should include being kept away from oil, paint, and greasy substances. In this connection, you should know that for purposes of satisfying the legal requirements, the U.S. Coast Guard does not consider as "Readily available" any PFDs found left in their original plastic wrappers since persons under stress may be unable to get them out quickly.

19.21 Ring Buoy

In addition to the PFDs mentioned in the previous paragraphs, and also required to be on board by federal regulations is at least one (1) U.S. Coast Guard approved throwable Type IV (life ring or buoyant cushion. This device must be carried where it is immediately available to those on deck.

Bertram supplies one Coast Guard approved ring buoy with 3 mounting brackets. You should mount this buoy in a suitable location. Bertram recommends that about 60 feet of light line be attached to the ring buoy. You may add to the one on-board "throwable" and/or replace the ring buoy with any other approved Type IV device if you so choose.

19.22 Radios As Emergency Equipment

The use of a marine radio as a method of obtaining help in an on board emergency cannot be over estimated. The possibilities of how reliable radio communications could add to the safety of the vessel and its crew are almost unlimited.

19.23 Visual Distress Signals



Do not use automotive road flares as your required night signals. The "slag" from road flares can cause injury and/or start a fire.

A Federal regulation became effective January 1, 1981, requiring that all vessels, 16 feet or larger, must carry a minimum of three (3) U.S. Coast Guard approved visual day and three (3) visual night distress signals, or three (3) approved day/night signals. These signals may be flares and/or smoke generating devices or battery powered automatic emergency signaling devices, and they must always be carried on board when ever you are operating in U.S. waters and on the high seas.

If you choose to carry pyrotechnic signaling devices, it is your responsibility to ensure that they have not exceeded their expiration date (42 months from date of manufacture). This expiration date is clearly marked on the approval label.

Bertram does not supply such equipment. You, the operator, should study the latest issue of the Coast Guard pamphlet "Visual Distress Signals for Recreational Boats", copy of which are available from the Department of Transportation, U. S. Coast Guard.

19.24 Sound Signals

A vessel over 12 meters in length falls within the Coast Guard category that requires that it carry both a bell and a whistle or a horn. Bertram has equipped this vessel, if applicable, with a suitable bell (unmounted) that satisfies the Federal Requirement for a bell for use in fog and an electrically powered horn that is suitable for the sound signals required by the Rules of the Road, fog, and other signaling. The horn push button switch is on the flybridge control console.

19.25 Calling At Ports Away From Home

You are not likely to have trouble with shore current in the United States. However, you should be careful when cruising abroad, check shore power for single phase, 120/240Vac, 60 Hz (some equipment may not operate properly on 50 Hertz).

Also, when cruising abroad, try to purchase fuel equal to American standards. (See Fuel Systems section for requirements in your engines.) Carry extra fuel filters with you, since replacements may be necessary.

In some areas, it is advisable to use water purifying tablets of the iodine type. Be sure to take these with you when cruising to places where the water supply is suspect.

NOTE:

This manual does not include information about international operation of the vessel.

19.26 Leaving Your Bertram

The following are procedures to follow when leaving your boat overnight or for a short period of time.

- Switch "OFF" all ignition or engine circuits.
- Lock all doors, windows, and hatches.
- Make sure mooring lines are well secured with adequate allowance for the tide.
- Fenders and spring lines should be set.
- Automatic bilge pumps should be left on the "AUTO" position. If for any reason your vessel is taking on water, the batteries voltage should be checked frequently and charged when required.

Disconnect the dockside fresh water hose from the vessel.

20. Diagrams

The following drawings and flow diagrams are representative of your boat. There is always the possibility that design changes by Bertram Yacht or additions to the boat caused by special requests of the buyer may not be reflected in the following material.

20.1 Docking Plan

20.2 Electrical Drawings

20.3 Mechanical flow Diagrams

REVISIONS

LET	DESCRIPTION	BY	DATE	APPV

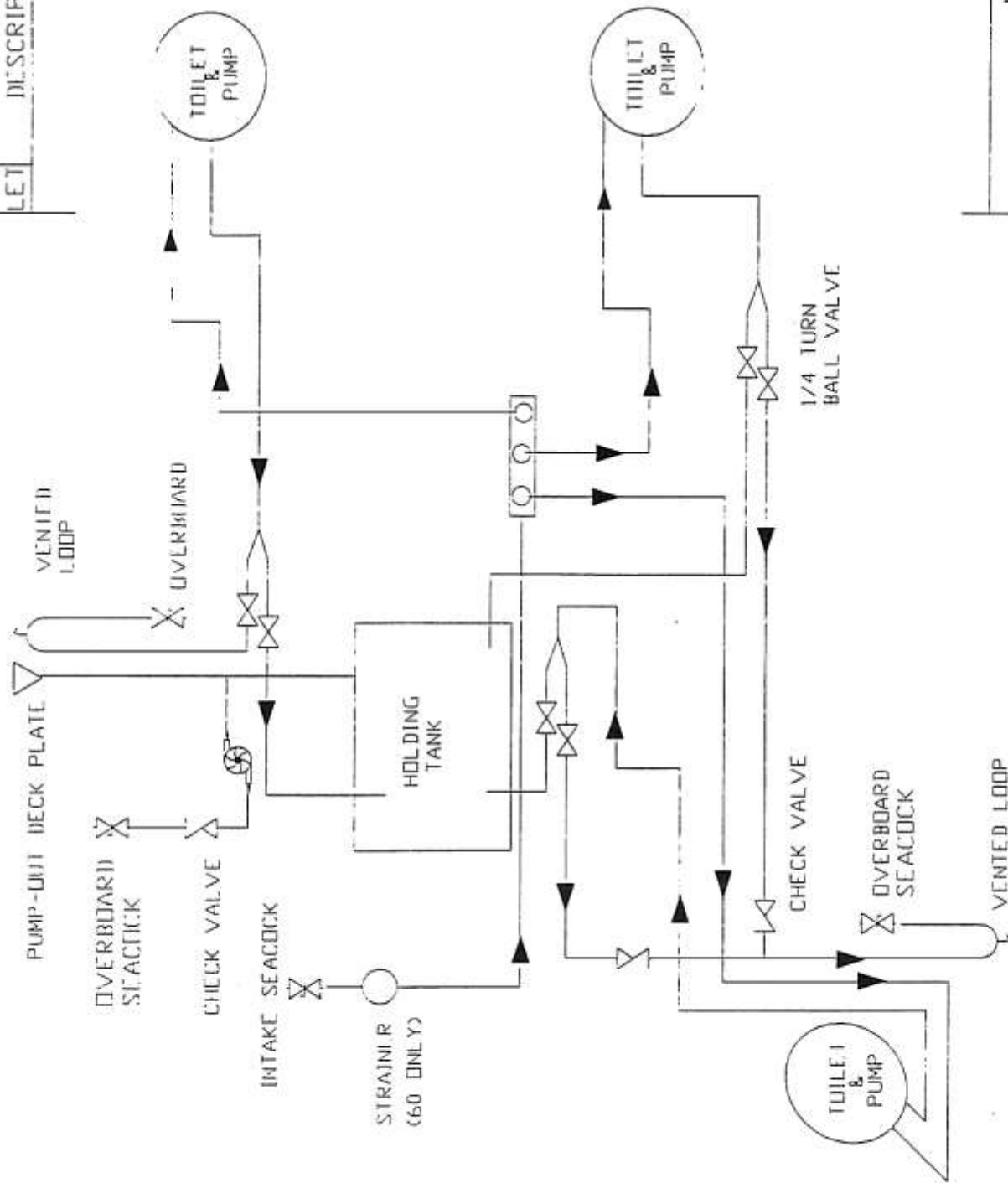

NOTES

SCALE	DATE	BY	APPV	DATE	REV
NONE <td>6-4-90 <td>LAGERMAN <td>GK <td> </td> <td> </td> </td></td></td>	6-4-90 <td>LAGERMAN <td>GK <td> </td> <td> </td> </td></td>	LAGERMAN <td>GK <td> </td> <td> </td> </td>	GK <td> </td> <td> </td>		
					A 10144-2

MODEL 43-60

TITLE

TOILET SYSTEM SCHEMATIC







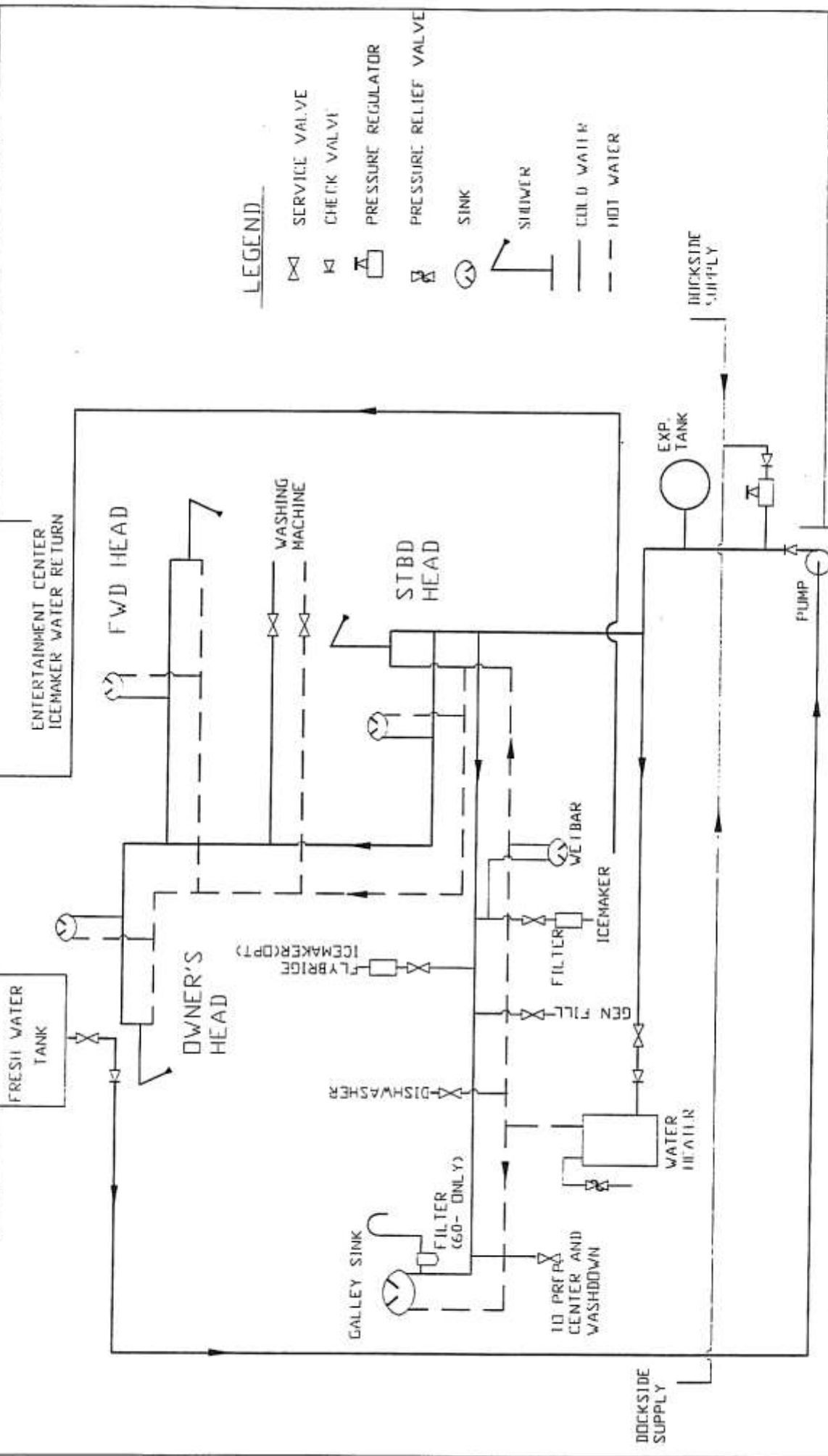

BERTRAM YACHT
MIAMI, FLORIDA, USA



REVISIONS			
LET	DESCRIPTION	BY	DATE



LEGEND

-  SERVICE VALVE
-  CHECK VALVE
-  PRESSURE REGULATOR
-  PRESSURE RELIEF VALVE
-  SINK
-  SHOWER
-  COLD WATER
-  HOT WATER

NOTES

SCALE NONE	BY HAGERMAN	APPV GK	REV
DATE 6-5-90	DATE	DATE	A 10144-4

MODEL 43-60
 TITLE
 FRESH WATER SYSTEM

BERTRAM YACHT
 MIAMI, FLORIDA, USA



REVISIONS

LET	DESCRIPTION	BY	DATE	APPV

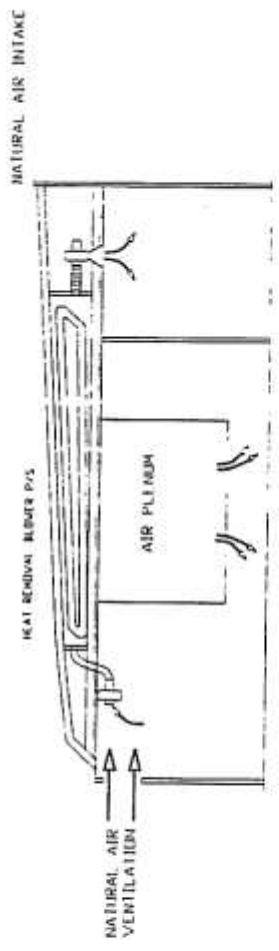

ENGINE ROOM BLOWERS & NATURAL VENTS
PROFILE VIEW

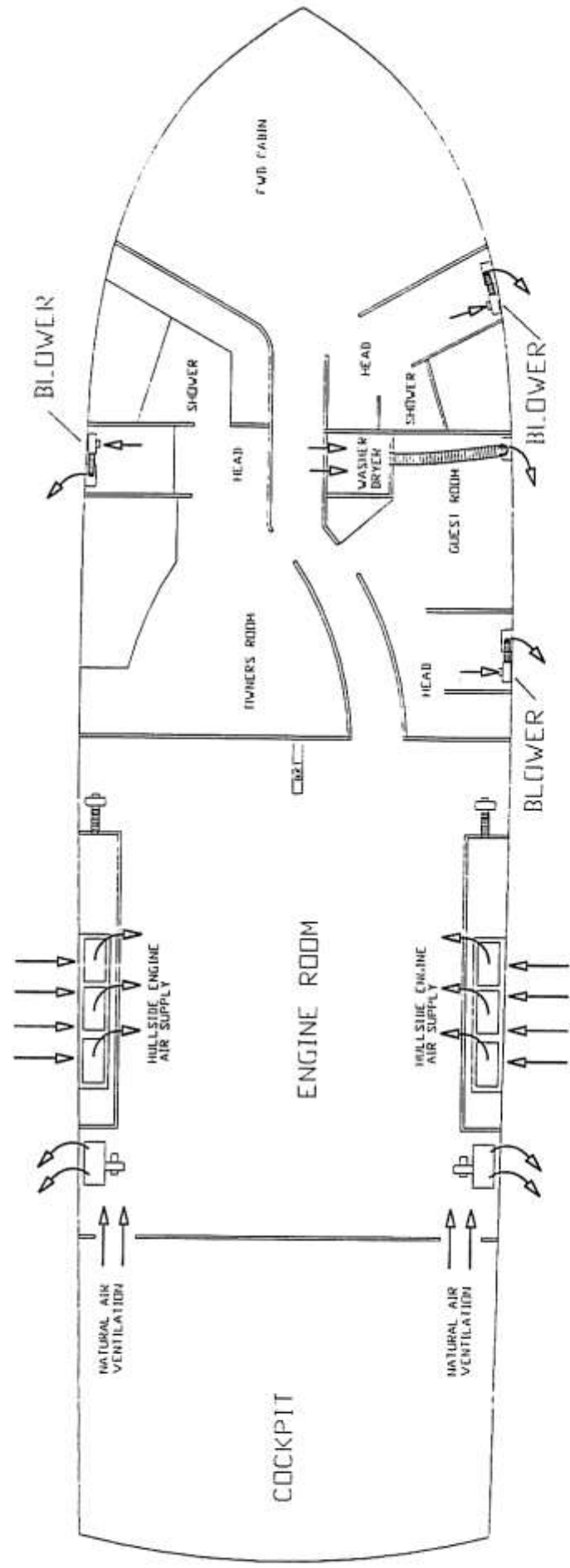

BLOWER & NATURAL VENTILATION-PLAN VIEW

NOTES

SCALE	NONE	REV	
BY	HAGERMAN	APPV	
DATE	6-4-90	DATE	
			A 10144-5

MODEL 43-60
TITLE
VENTILATION-NATURAL & BLOWER

BERTRAM YACHT
MIAMI, FLORIDA, USA



REVISIONS

DESCRIPTION

BY

DATE

APPV

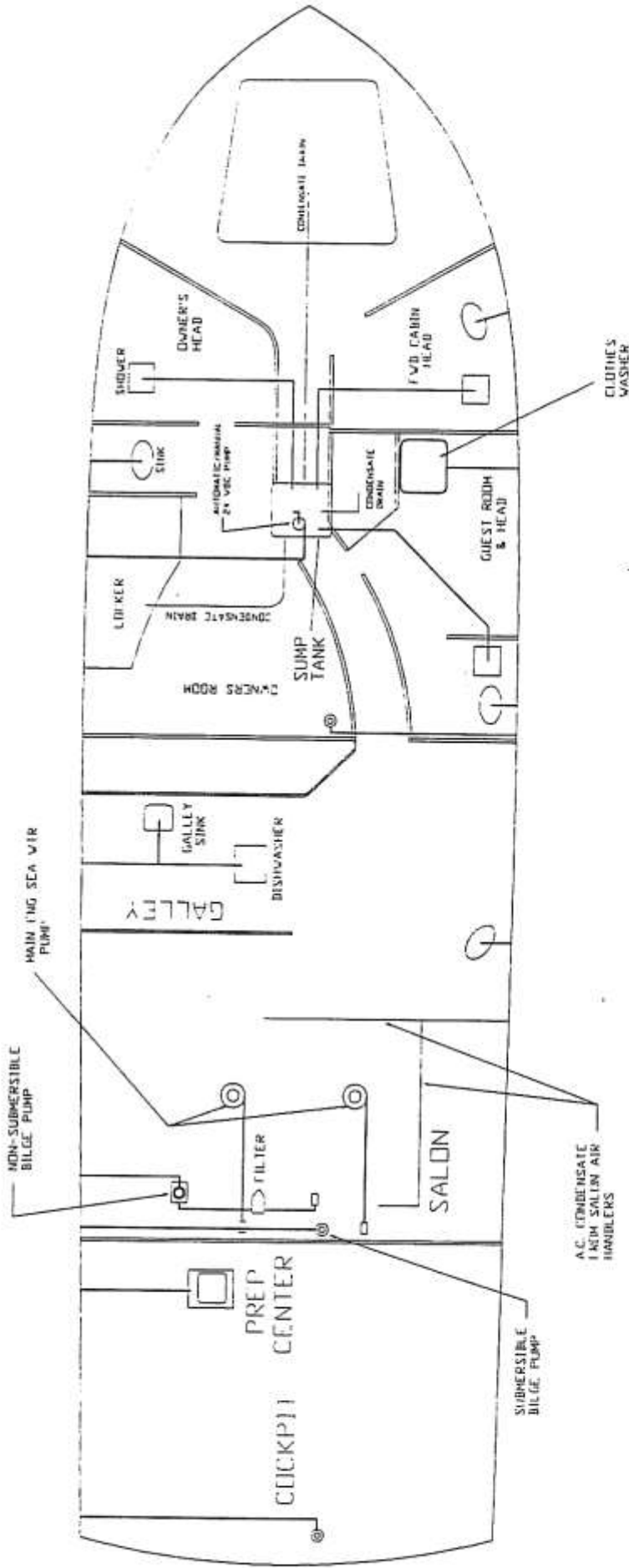

NOTES

MODEL 43-60
TITLE

DRAINAGE & BILGE SYSTEM

SCALE NONE
BY HAGERMAN
DATE 6-4-90
APPV

REV
A 10144-6



BERTRAM YACHT
MIAMI, FLORIDA, USA

REVISIONS

LET	DESCRIPTION	BY	DATE	APPV

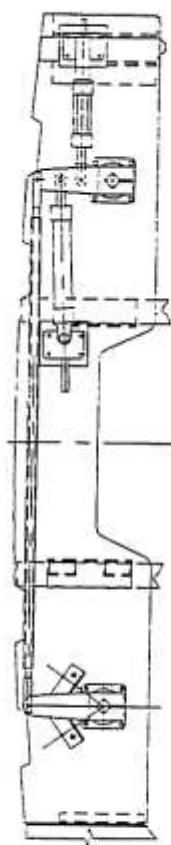

TRANSOM
JOINING LOWER STEERING

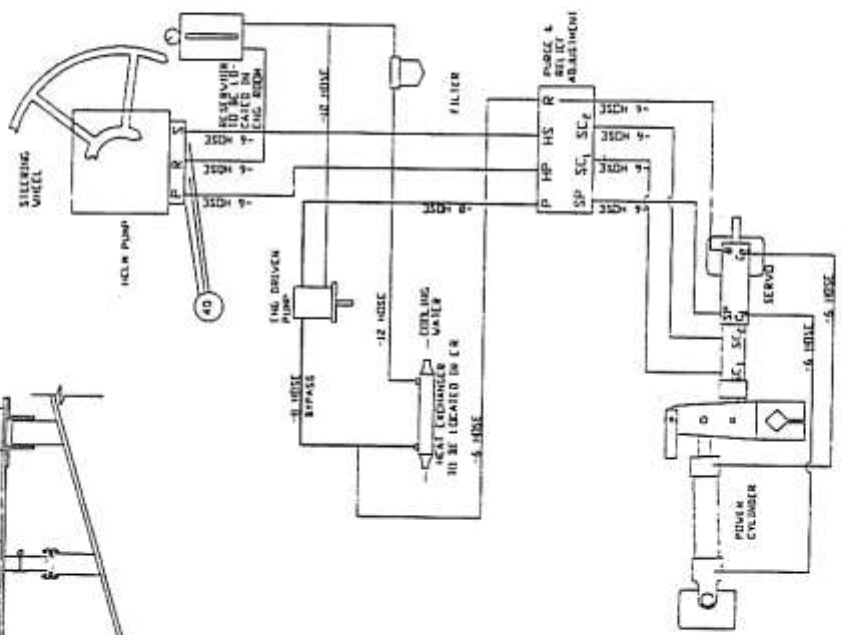
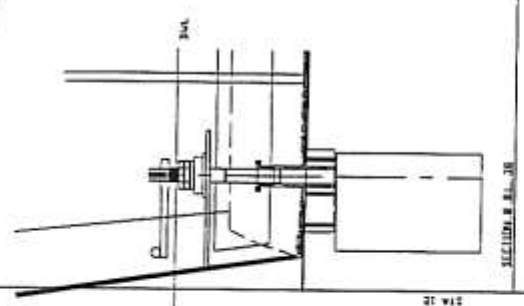

NOTES

<p>MODEL 43-60</p> <p>TITLE STEERING INSTALLATION, AFT (POWER ASSIST)</p>	<p>SCALE</p>	<p>BY HAGERMAN</p>	<p>APPV</p>	<p>REV</p>
<p>DATE B-9-89</p>	<p>DATE</p>	<p>DATE</p>	<p>DATE</p>	<p>A 10144-10</p>



BERTRAM YACHT
MIAMI, FLORIDA, USA

REVISIONS			
LET	DESCRIPTION	BY	DATE

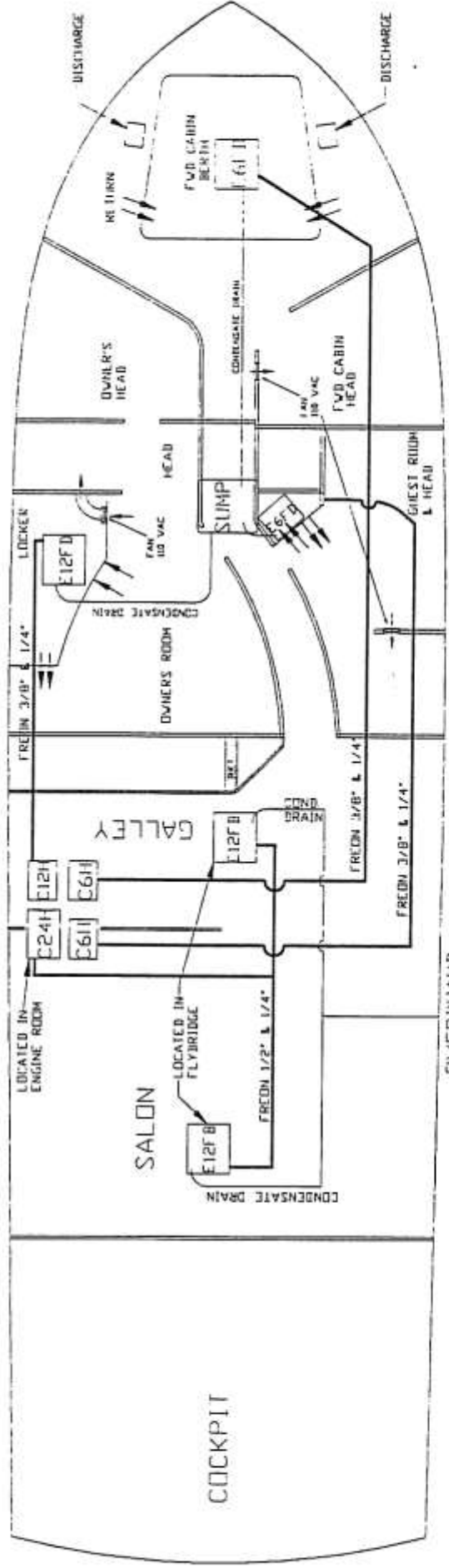
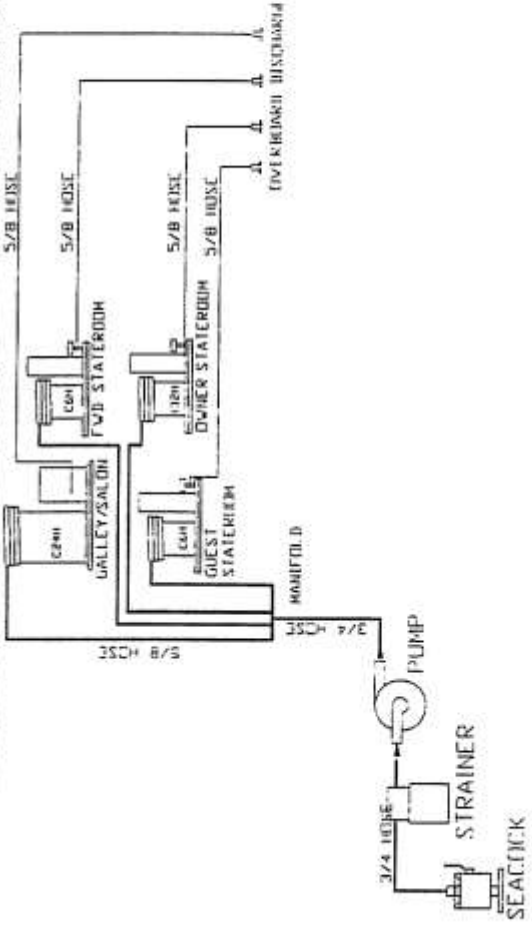

MODEL 605	SCALE NONE	NOTES	REV
TITLE	BY HAGERMAN	AI'PV	A
AIR CONDITIONING SYSTEM	DATE 6-4-90	DATE	10144-1

MODEL 605
TITLE
AIR CONDITIONING SYSTEM

BERTRAM YACHT
MIAMI, FLORIDA, USA



REVISIONS

LET	DESCRIPTION	BY	DATE	APPV

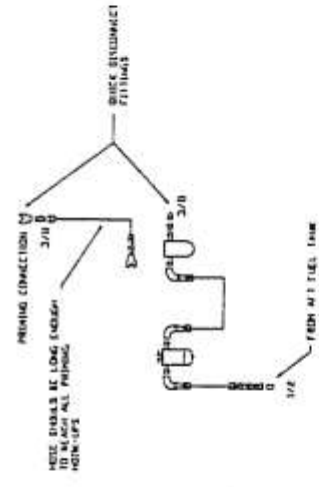
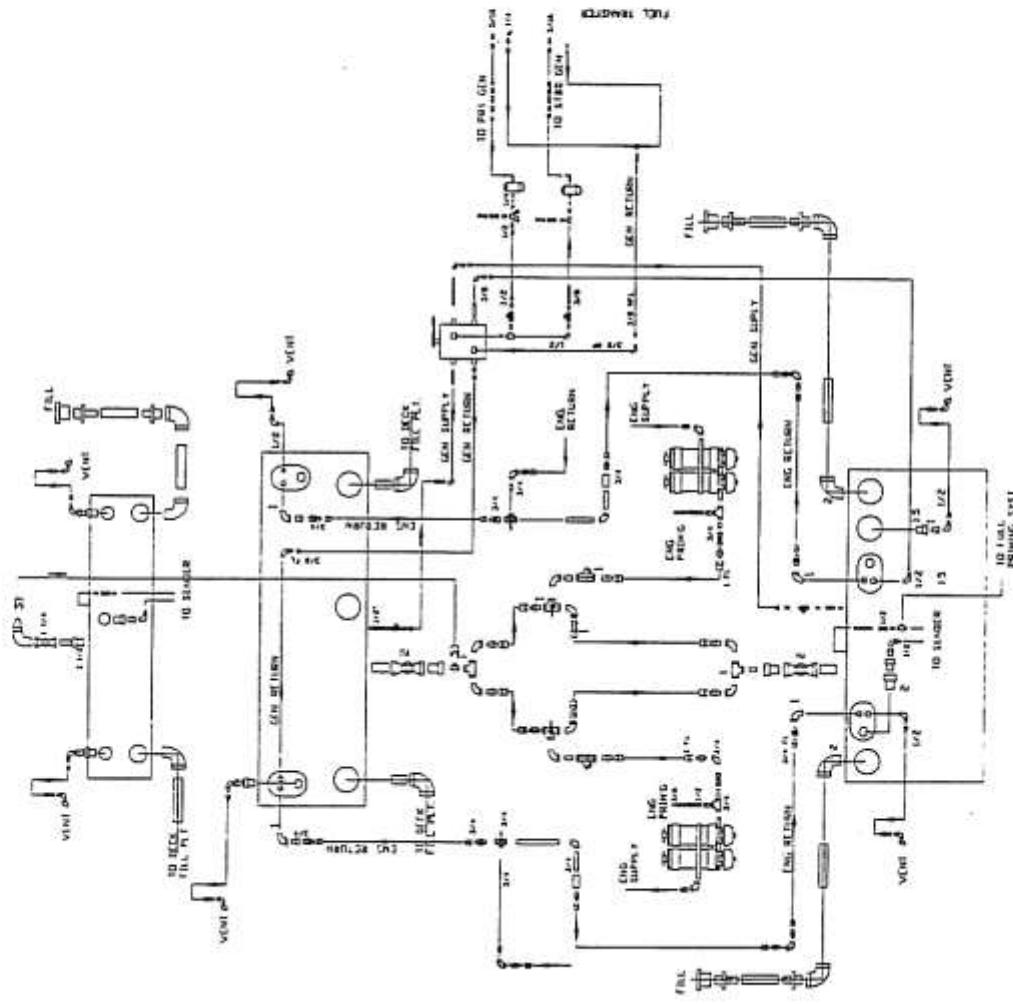

FUEL PRIMING SYSTEM

NOTES

SCALE	LINE	REV
BYR L	APPV	A 11070
DATE	DATE	
2/21/95		

MODEL 605
TITLE FUEL SYSTEM,
ENG. & GEN.

BERTRAM YACHT
MIAMI, FLORIDA, USA



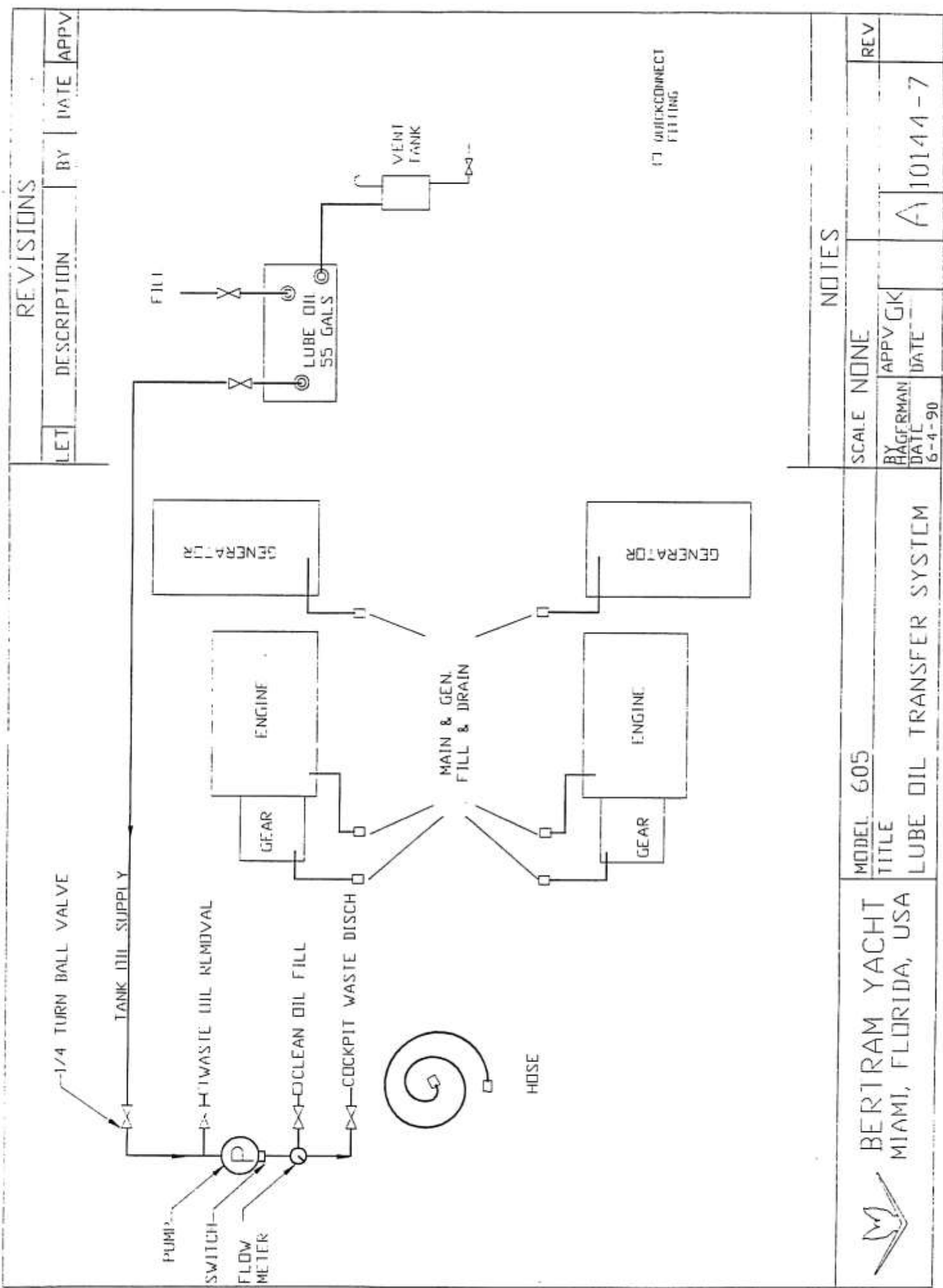

REVISIONS

LET	DESCRIPTION	BY	DATE	APPV

NOTES

SCALE	NONE	APPV	GK	REV
BY	RAGERMAN	DATE	6-4-90	A
TITLE			10144-7	

MODEL 605
 TITLE
 LUBE OIL TRANSFER SYSTEM

BERTRAM YACHT
 MIAMI, FLORIDA, USA



WATERCONNECT FITTING

Index

A

A.C. Electrical

- Circuit protection, 10-82
- Distribution, 10-78
- G.F.C.I outlets, 10-83
- G.F.C.I. operation, 10-83
- General information, 10-78
- International use, 10-84
- Power selection, 10-79
- Shore power, 10-81

Air Conditioning

- Location of equipment, 4-23
- Operation, 11-86 - 11-87

B

Batteries

- Care, 17-115 - 17-116
- Location, 4-26
- Specifications, 3-17

Blowers

- Location, 4-22
- Specifications, 3-19

C

Cablemaster

- Location, 4-26
- Operation, 16-107

Compass

- Compensation, 19-128
- General, 19-129 - 19-131

Converter

- General, 10-84

Corrosion

- Bonding system, 17-121
- Crevice, 17-120
- Galvanic, 17-121

D

D.C. Electrical

- Battery charging sources, 9-72
- Battery disc. switches, 9-74
- Circuit protection, 9-73
- Distribution, 9-72
- Helm gauge, 8-67
- Paralleling the batteries, 9-74

DDEC

- 12V Power source, 9-75, 9-77

Diagrams

- Include with manual, 20-144

Draft & Height

- How to measure draft, 19-128
- Recording height, 19-128

E

Engines

- Airsep filters, 8-52
- Controls & Maneuvering, 7-39
- Cooling, 8-55
- General information, 8-44 - 8-45
- Lubrication, 8-54
- Specifications, 3-16
- Starting & stopping, 8-46 - 8-48

F

Fiberglass

- Bottom blisters, 18-125
- Care, 18-122 - 18-123
- Painting, 18-124

Fire Extinguishers

- Fixed system, 6-31
- Location, 4-25
- Portable bottles, 6-35

Fresh Water System

- Dockside use, 13-97
- Pump, 13-94
- Tank, 13-93
- Tank location, 4-21

Fuel System

- Fuel, 17-117
- General, 8-49 - 8-51
- Tank gallonage, 3-19
- Tank location, 4-20

G

Galvanic Isolator

- Description, 10-84

Gauges

- Coolant temperature, 8-67
- Gear oil pressure, 8-67
- Gear oil temperature, 8-67
- Lube oil pressure, 8-67
- Tachometer, 8-68

Generator

- Operation, 10-79 - 10-81
- Specifications, 3-18

Gray Water Tank

- Location, 13-96

- H**
 Hatch Dogs
 Adjustment, 17-118
 Holding Tank (Black Water)
 Monitor & pumping, 12-91
- M**
 Maintenance
 General information, 1-3
 Marine Gear
 General, 8-57
 Monitors
 Engine, 8-69 - 8-70
 Fire, 6-30
 Gray water tank, 13-96
 Location, 4-24
- N**
 Navigation Lights
 Operation, 16-110
- P**
 Plastics
 Care of Acrylics & ABS parts, 17-119
 Propellers
 Changing specifications, 8-58
 Installation, 8-60
 Specifications, 3-17
 Vibrations, 19-139
 Pumps
 Bilge pump operation, 14-99
 Bilge pumps location, 4-22
 Emergency main engines pumps, 14-100
 See also Fresh water
 Lube oil transfer location, 4-26
 Seawater pump location, 4-26
 Seawater washdown, 16-105
 Shower sump, 13-96
 Shower sump location, 4-21
 Specifications, 3-19
- R**
 Rudder
 Packing the stuffing box, 8-65
- S**
 Safety Items
 Carbon Monoxide Gas, 5-27
 Classes of fires, 6-36
 Damage to underwater equip., 19-127
 Distress Flares, 19-142
 Emergency evacuation, 6-38
 Fire fighting plan, 6-37
 Life preservers(PFD), 19-140
 Overhead rod locker, 16-111
 Propeller hazard, 19-134
 Rags & wipes, 17-120
 Refloating a grounded vessel, 19-138
 Ring buoy, 19-141
 Rough weather preparations, 19-135
 Running aground, 19-137
 Searchlight, 16-109
 Sound signaling equipment, 19-142
 Swim Platform, 16-109
 Towing hazards, 19-139
 Use of fishing tower, 19-133
 Warnings, cautions, & notes, 1-2
 When underway, 19-134
- Shafts**
 Alignment, 8-58 - 8-59
 Coupling, 8-62 - 8-63
 Log & stuffing box, 8-64
 Log sprayshield, 8-65
 Repacking the stuffing box, 8-65
 Replacement, 8-62
 Specifications, 3-17
- T**
 Toilet
 Discharge inside U.S., 12-90
 Discharge outside U.S., 12-91
 General Information, 12-88
 Location, 4-25
 Operation, 12-90
 Trim Tabs
 Controls, 16-113
 Location, 4-26
- U**
 U.S. Coast Guard
 Regulations, 1-3
- V**
 Ventilation
 Engine room, stateroom, toilet, & galley, 15-103
 Vessel
 Specifications, 3-15
- W**
 Water Heater
 Operation, 13-95
 Windlass
 Operation, 16-106 - 16-107