

Once Upon A Time . . . The Sorrowful Mysteries

The Sorrowful Mysteries are the stories of the sad and difficult times in Jesus' life. They teach us how we can be strong and faithful during the sad and difficult times in our life.



Once Upon A Time ... The Sorrowful Mysteries

If you are just learning to pray the Rosary, this is a good way to begin:

1. Hold the cross of your Rosary in your hand, make the Sign of the Cross, and pray "In the name of the Father, and of the Son and of the Holy Spirit. Amen."
2. If you have been taught to pray the Apostles' Creed, pray that also. The Creed names the things we believe as Catholics. Pray it slowly, so you can think about what the words mean.
3. Move your fingers to the first large bead. The larger beads tell us that we are to pray the Our Father. That is the prayer that Jesus taught us.
4. Move your fingers to the next 3 small beads. The small beads are for the Hail Marys.
5. After these Hail Marys, pray The Glory Be.
6. Now it is time to begin The Mysteries. Let's begin with the first Mystery. Ask someone to tell you what happened or look it up in the Bible.
7. Now slowly pray 10 Hail Marys on the small beads and 1 Glory Be when you are done.

That was great for the first time! Tomorrow try the second Mystery. When you have thought about all 5 Mysteries and prayed all 53 Hail Marys, you will have completed the Sorrowful Mysteries of the Rosary.

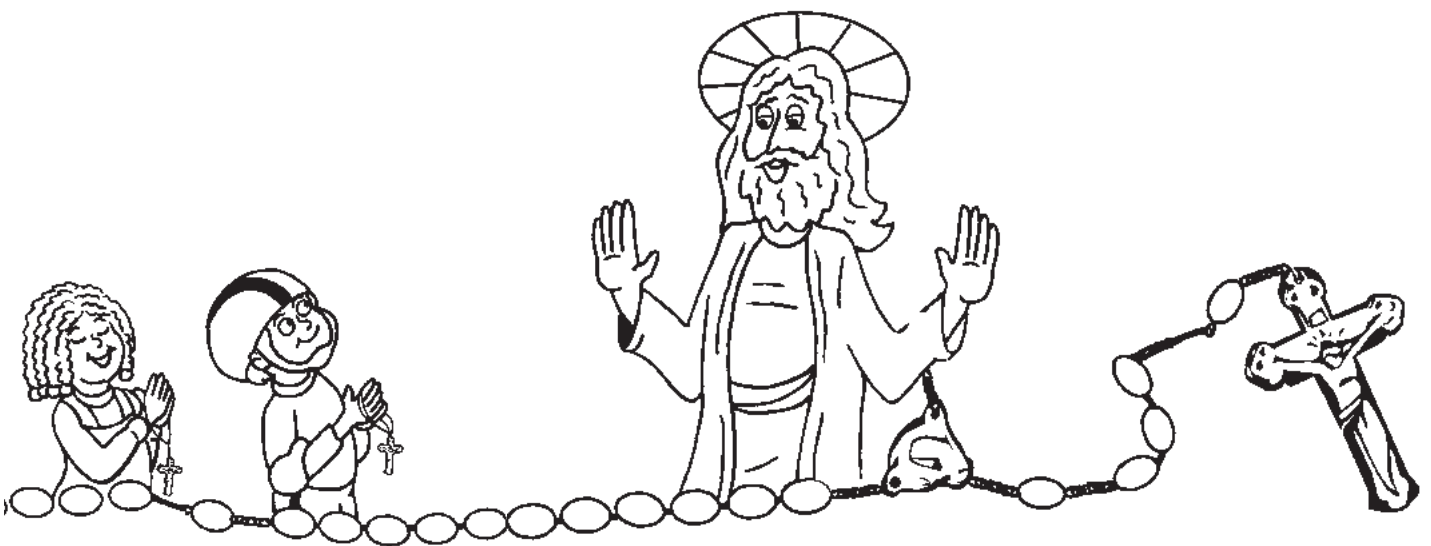

The Prayers of the Rosary

The Apostles' Creed

I believe in God,
the Father almighty,
Creator of heaven and earth,
and in Jesus Christ, his only Son, our Lord,
who was conceived by the Holy Spirit,
born of the Virgin Mary,
suffered under Pontius Pilate,
was crucified, died and was buried;
he descended into hell;
on the third day he rose again from the dead;
he ascended into heaven,
and is seated at the right hand of God the
Father almighty;
from there he will come to judge the living and
the dead.

I believe in the Holy Spirit,
the holy catholic Church,
the communion of saints,
the forgiveness of sins,
the resurrection of the body,
and life everlasting.
Amen.

The Our Father

Our Father, who art in heaven,
hallowed be thy name;
thy kingdom come;
thy will be done on earth as it is in heaven.
Give us this day our daily bread;
and forgive us our trespasses
as we forgive those who trespass
against us;
and lead us not into temptation,
but deliver us from evil.
Amen.

The Hail Mary

Hail Mary, full of grace, the Lord is with you;
blessed are you among women,
and blessed is the fruit of your womb, Jesus.
Holy Mary, Mother of God,
pray for us sinners
now and at the hour of our death.
Amen.

The Glory Be (The Doxology)

Glory be to the Father, the Son,
and the Holy Spirit;
as it was in the beginning, is now,
and ever shall be,
world without end.
Amen.

The Hail Holy Queen (The Salve Regina)

Hail, holy Queen, mother of mercy,
our life, our sweetness, and our hope.
To you we cry, poor banished children of Eve;
to you we send up our sighs,
mourning and weeping in this valley of tears.
Turn, then, most gracious advocate,
your eyes of mercy toward us;
and after this, our exile,
show unto us the blessed fruit of your womb,
Jesus.

O clement, O loving, O sweet Virgin Mary.

Pray for us, O Holy Mother of God;

that we may be worthy of the
promises of Christ.
Amen.

The Five Sorrowful Mysteries

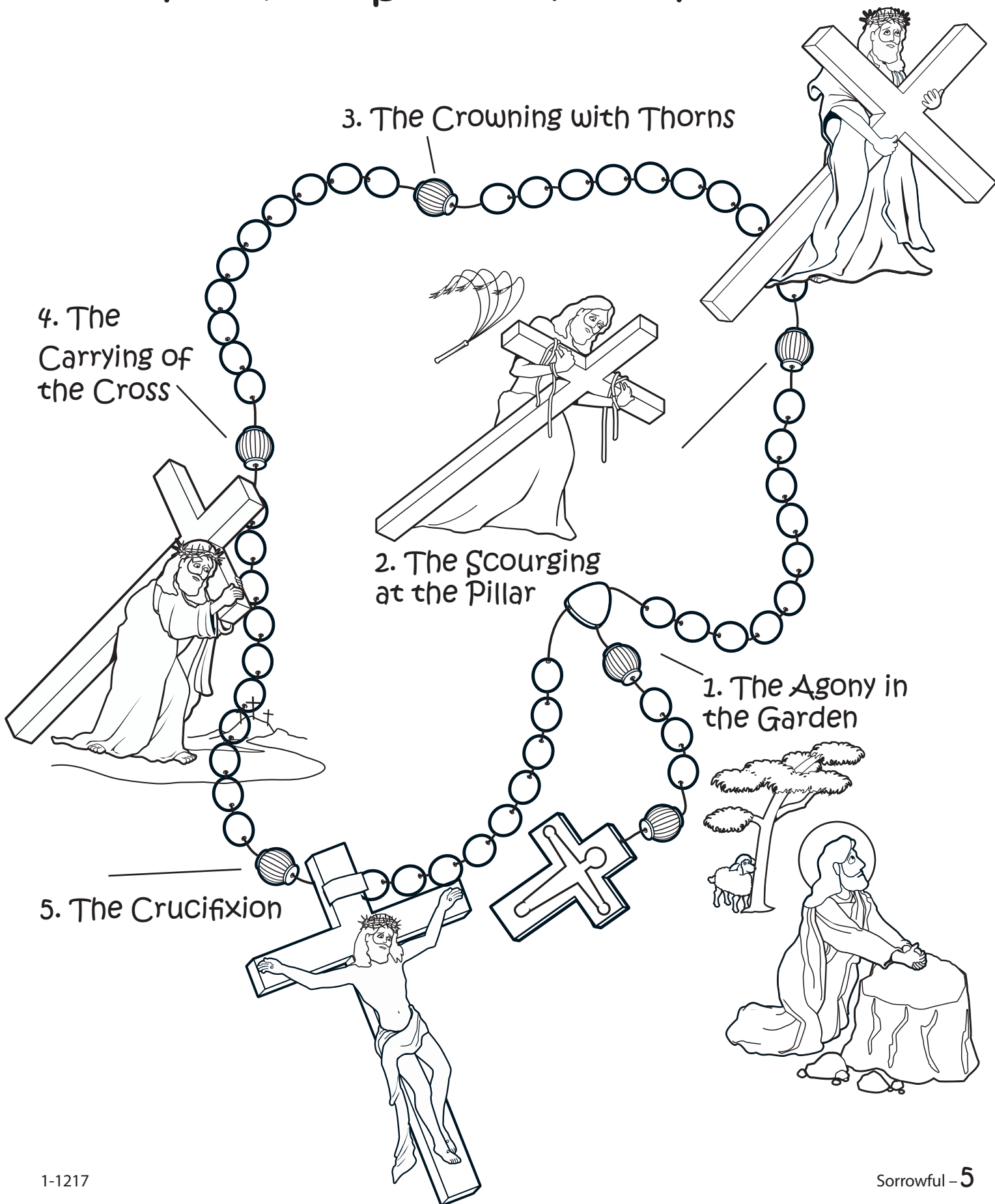

Let's pray the Sorrowful Mysteries of the Rosary!

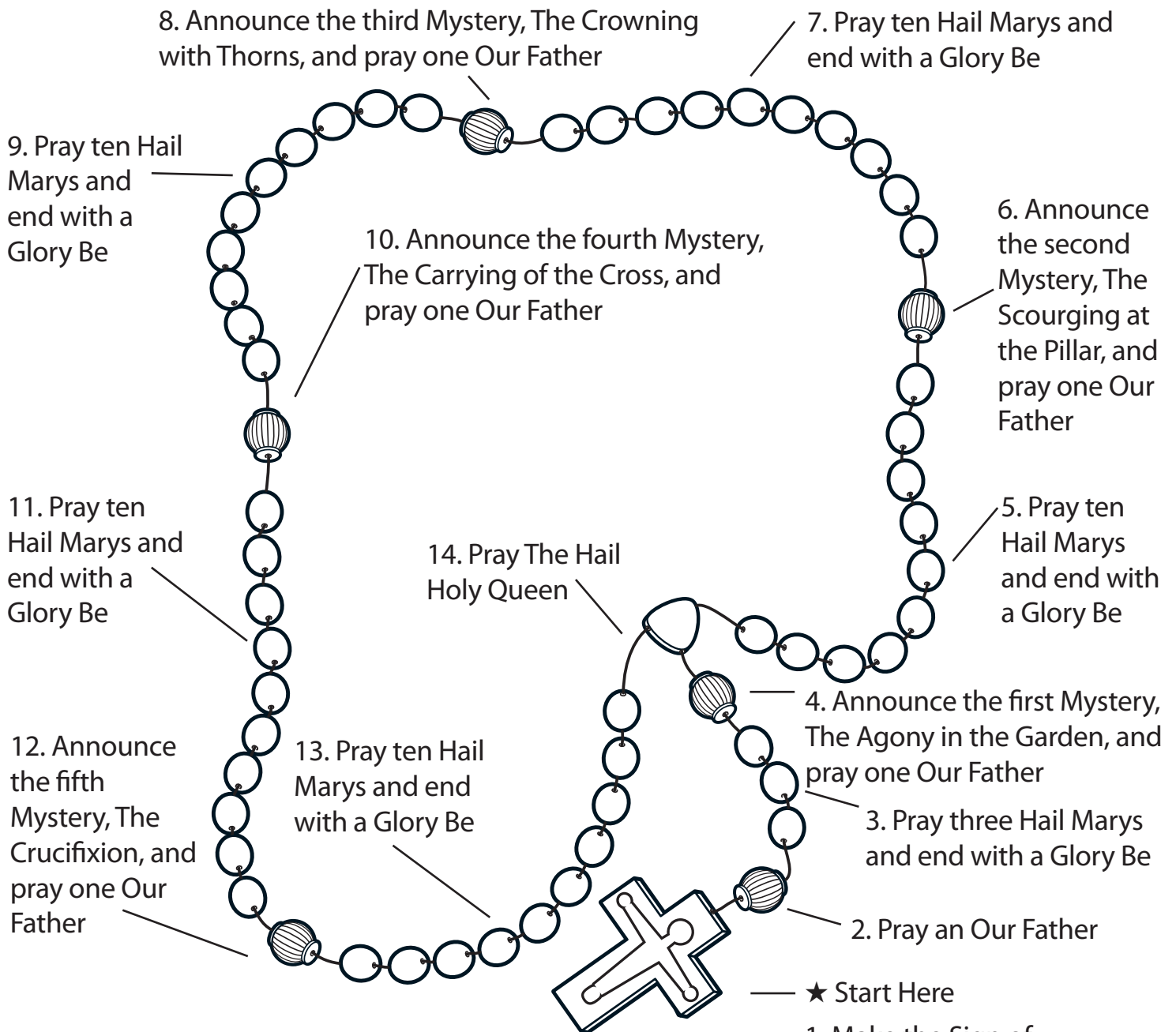

1. Make the Sign of the Cross and pray the Apostles' Creed

Note: If desired, follow any local customs for other prayers at this point.

End with the Sign of the Cross

The Agony in the Garden

The First Sorrowful Mystery

Read this story in the Bible –
Matthew 26:36-46



After you do the activities,
gather with your family or
class and pray 1 Our Father,
10 Hail Marys and 1 Glory Be.

Pray for people around the
world who are lonely
and afraid.

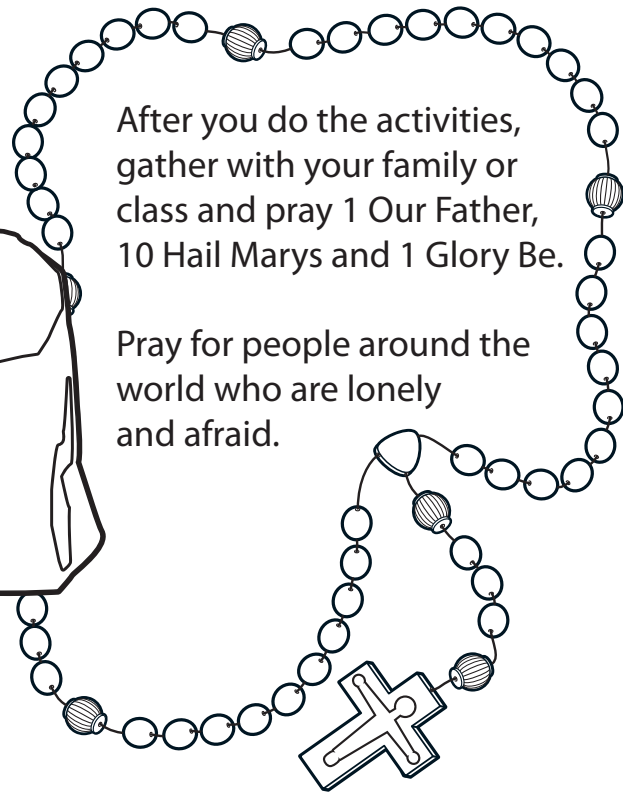

The Garden of Gethsemane

Jesus prayed in the Garden of Gethsemane to ask God for strength and courage when he was lonely and afraid. You can pray to God when you're afraid and sad too. Write your own prayer below:

Dear God,

Amen.

Crossword Puzzle

Answer the clues to reveal words that are comforting when you're struggling.

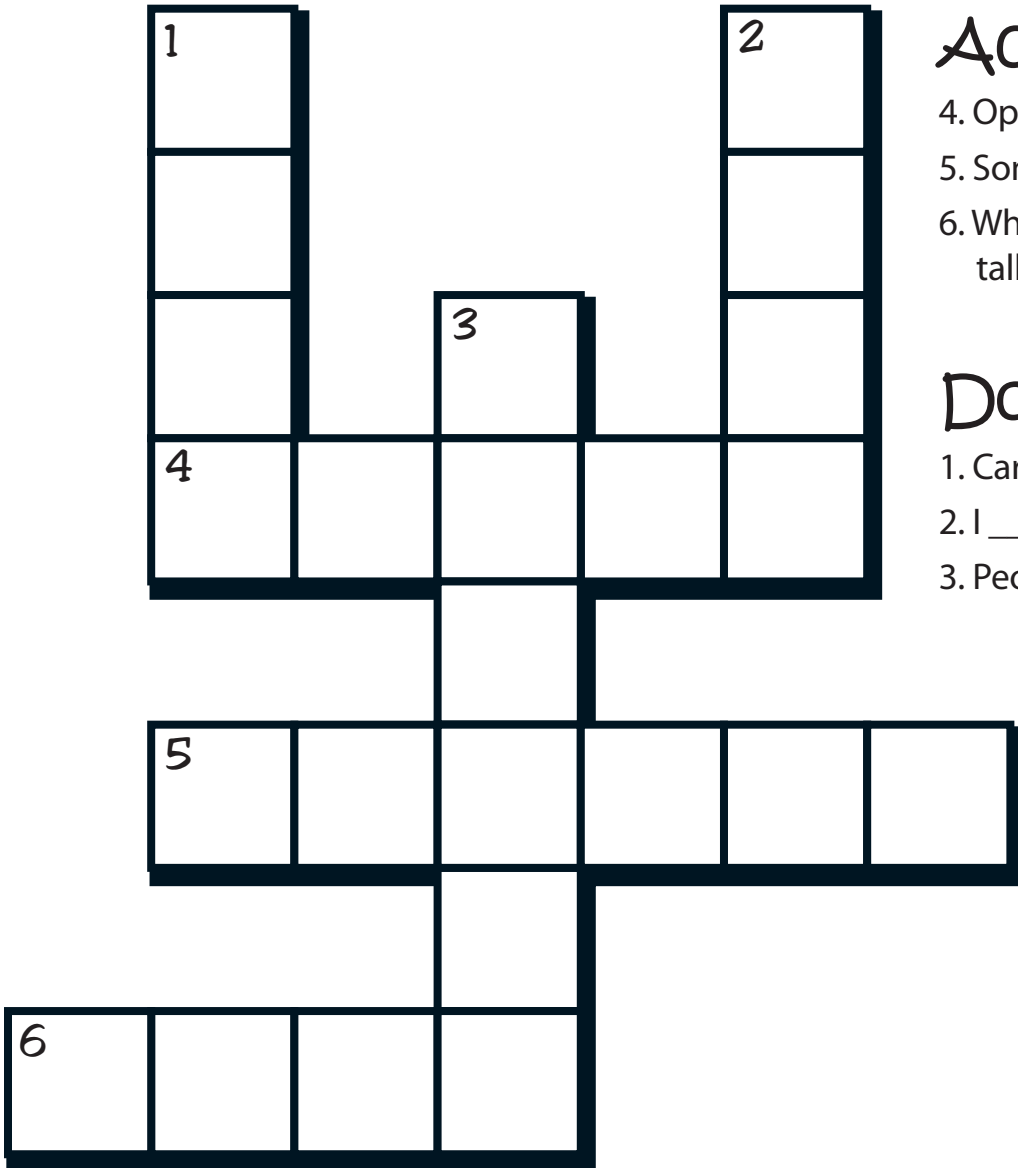

Across

- 4. Opposite of war
- 5. Someone you're close to
- 6. What you do when you talk to Jesus

Down

- 1. Care for someone
- 2. I _____ my parents
- 3. People who love you

Peace
Friend
Love
Help
Family
Pray

When do you pray?

Draw the hands on the clock to show when you prayed today.

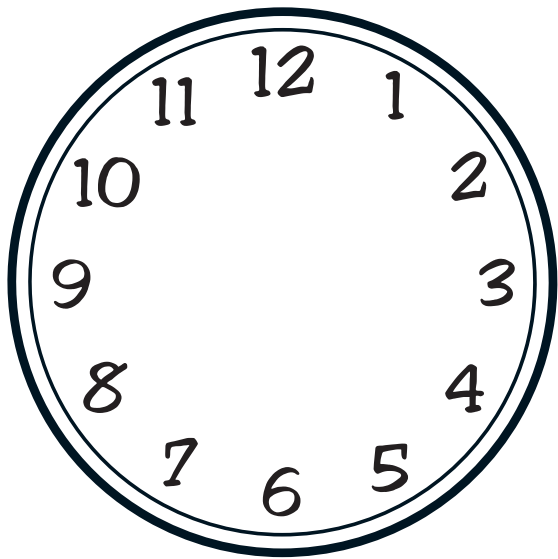

Morning

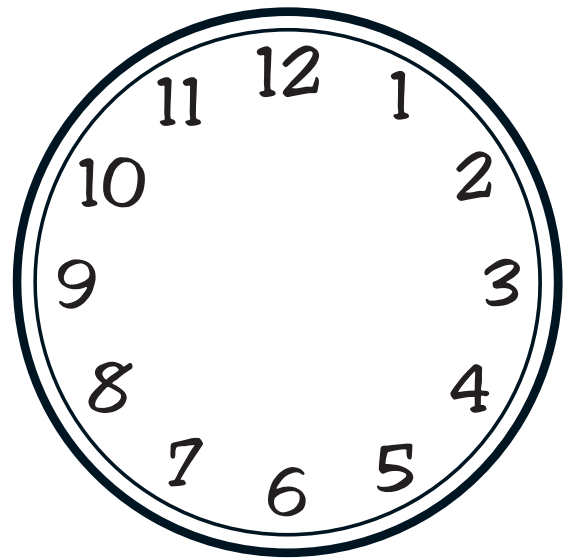

Lunch

Every hour of every day
We take the time to kneel and pray.
We ask our God, who loves us so
To keep us safe
Wherever we go.
Amen.

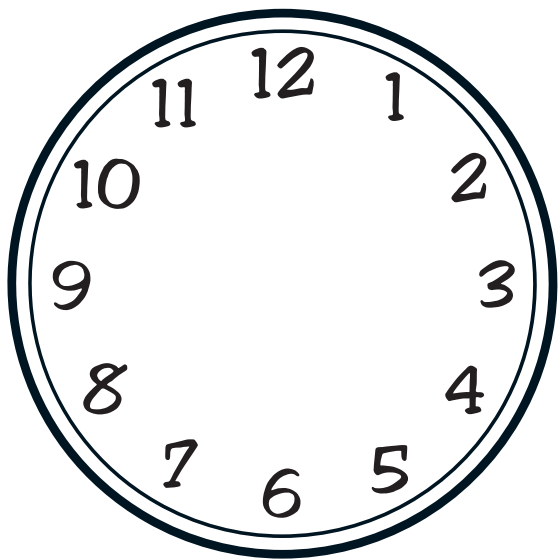

Dinner

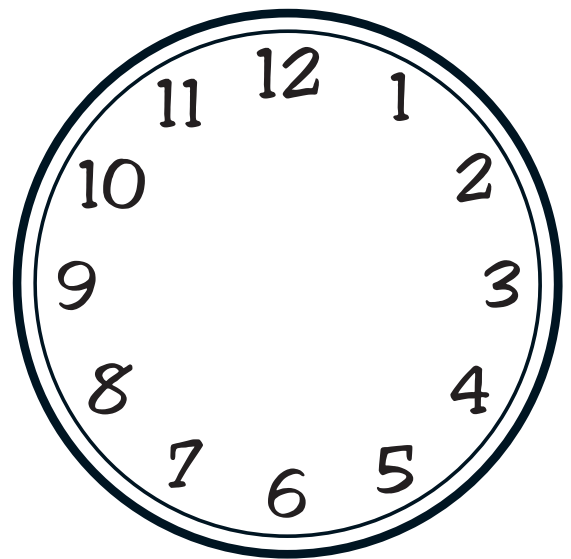

Bedtime

The Scourging at the Pillar

The Second Sorrowful Mystery

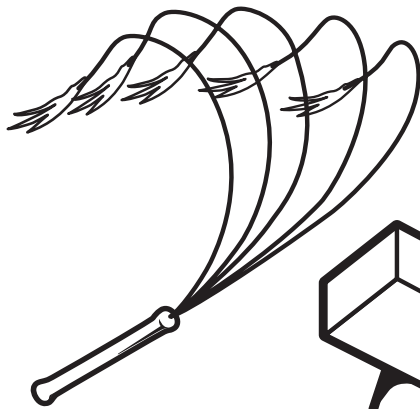

Read this story in the Bible –
Matthew 27:26

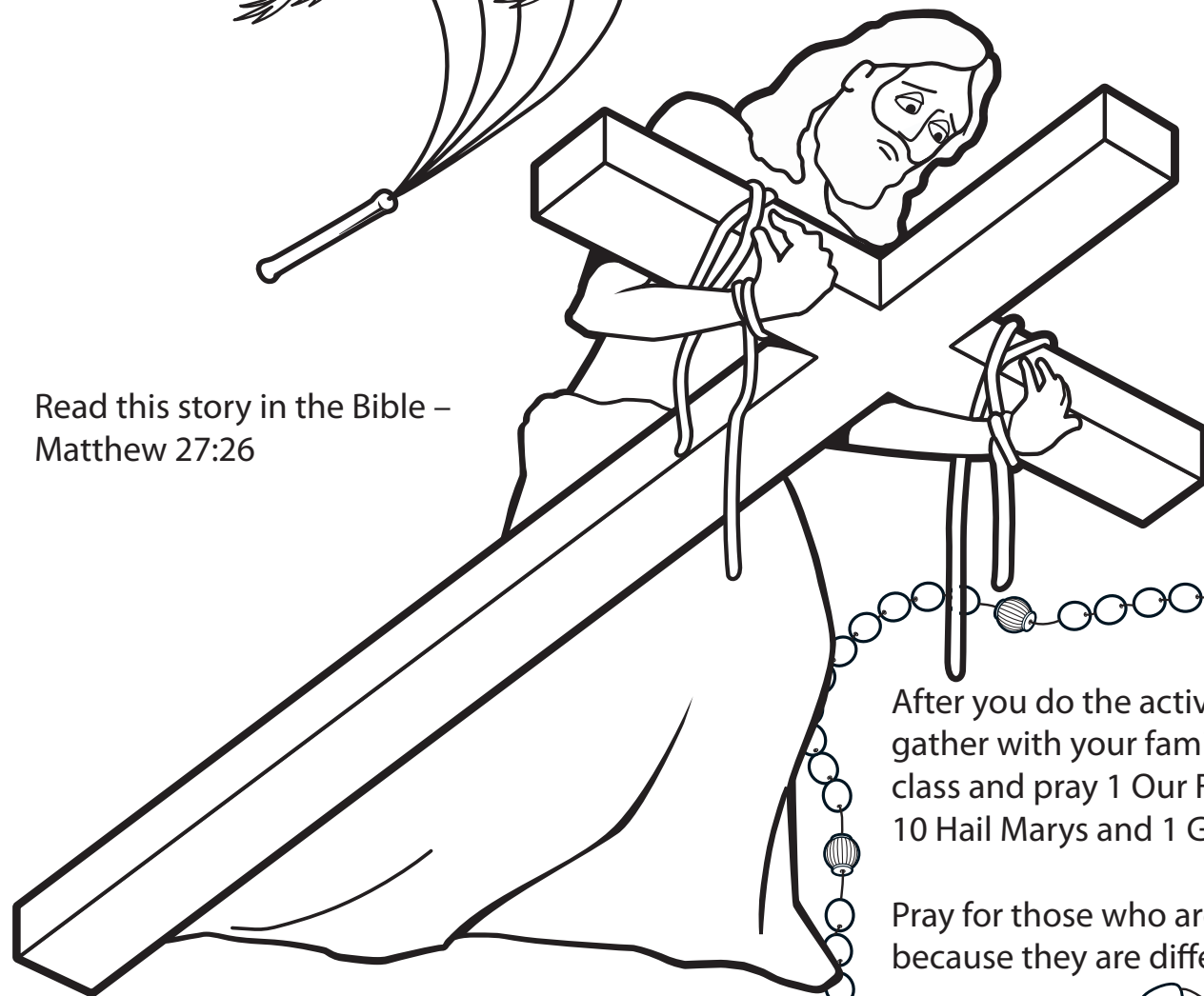

After you do the activities,
gather with your family or
class and pray 1 Our Father,
10 Hail Marys and 1 Glory Be.

Pray for those who are hurt
because they are different.

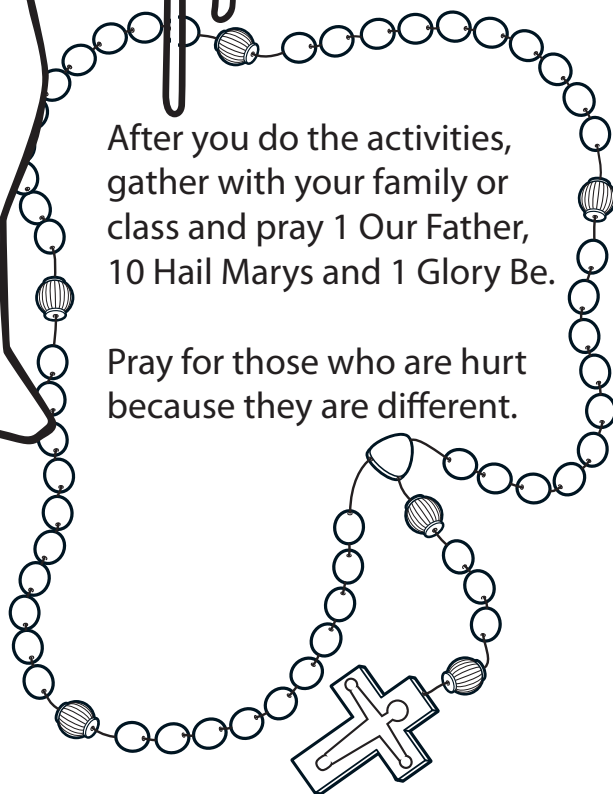

Draw a picture of how
you feel right now.

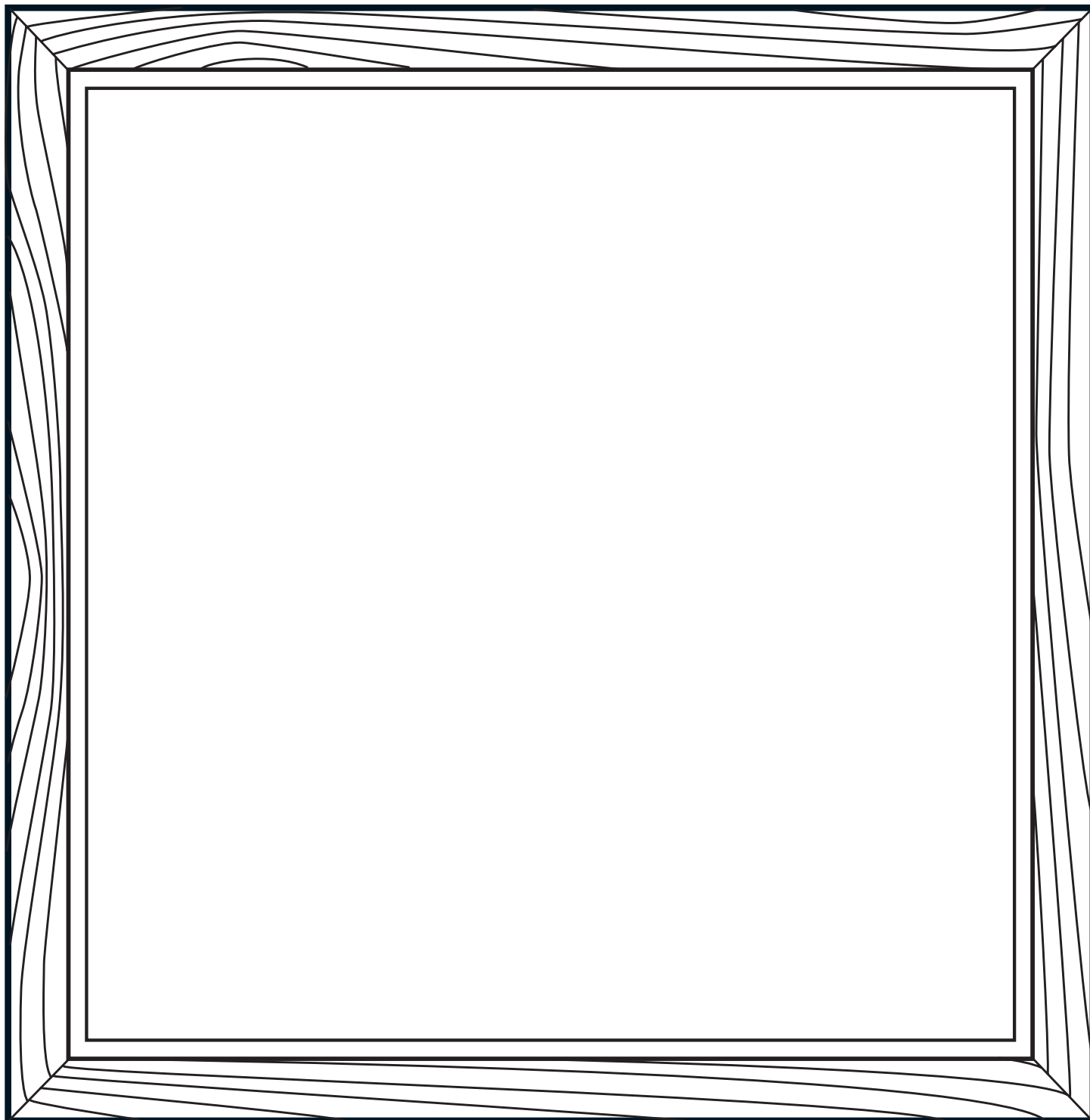

Jesus loves you always! No matter how you feel!

Unscramble the words to find different feelings:

dsa _____

oyj _____

hpypa _____

ylils _____

srroy _____

nortsg _____

drite _____

eixcetd _____

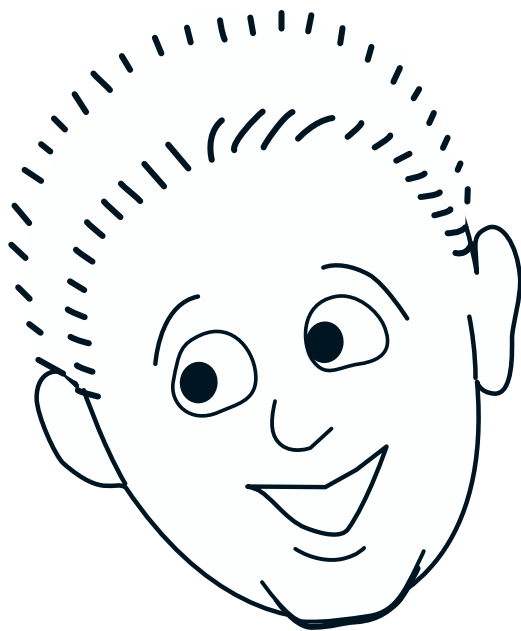

Can you find the hidden message?

☆ = O	△ = U
□ = A	■ = B
🌸 = I	😊 = L
◇ = E	♥ = M
🎈 = Y	🌀 = P
	🍊 = F

🌀 R □ 🎈

■ ◇ K 🌸 N D

D ☆ G ☆ ☆ D

🌀 😊 □ 🎈 🍊 □ 🌸 R

□ 😊 W □ 🎈 S 🍊 ☆ R G 🌸 V ◇

The Crowning with Thorns

The Third Sorrowful Mystery

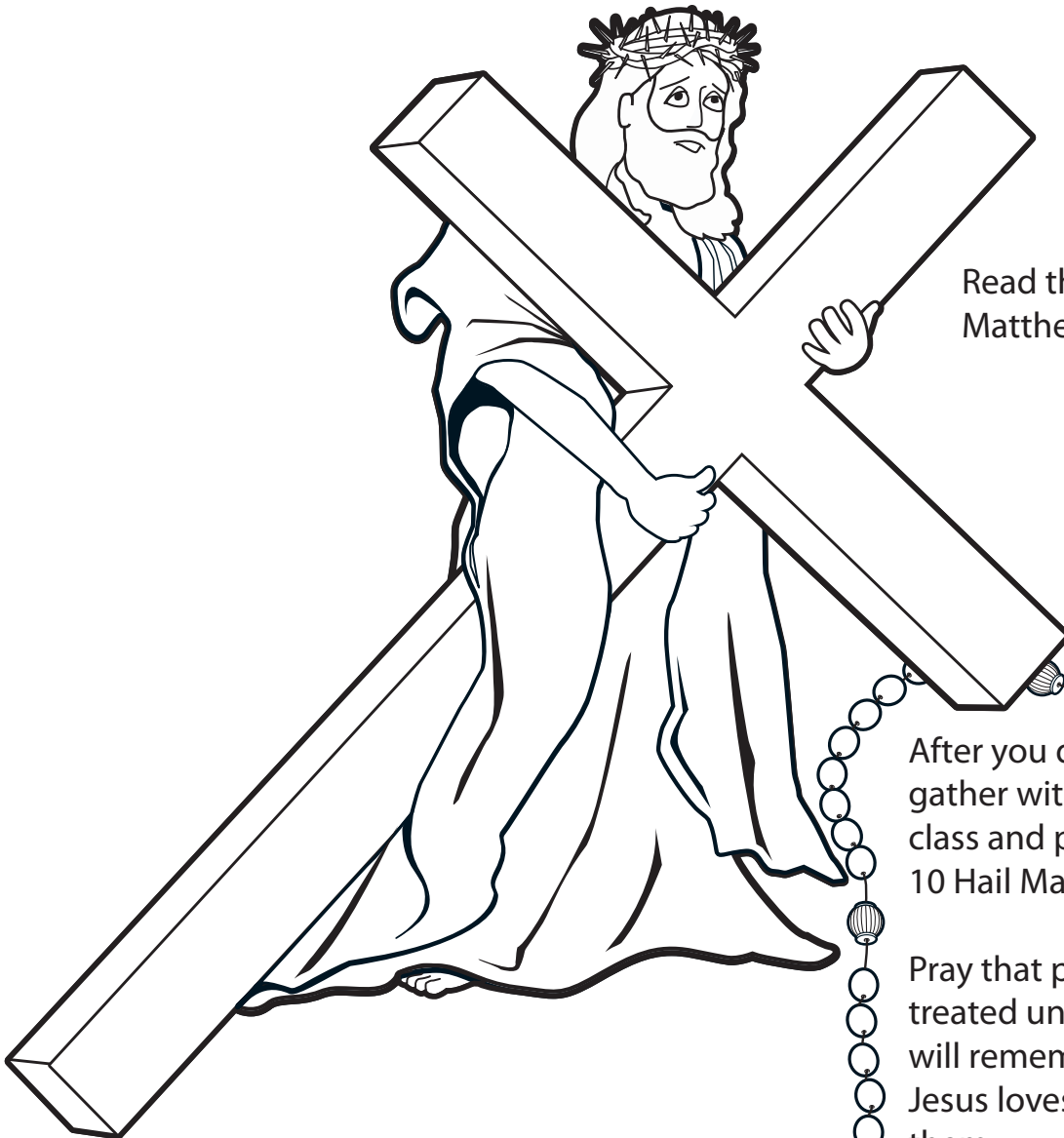

Read this story in the Bible –
Matthew 27:27-31

After you do the activities,
gather with your family or
class and pray 1 Our Father,
10 Hail Marys and 1 Glory Be.

Pray that people who are
treated unfairly
will remember
Jesus loves
them.

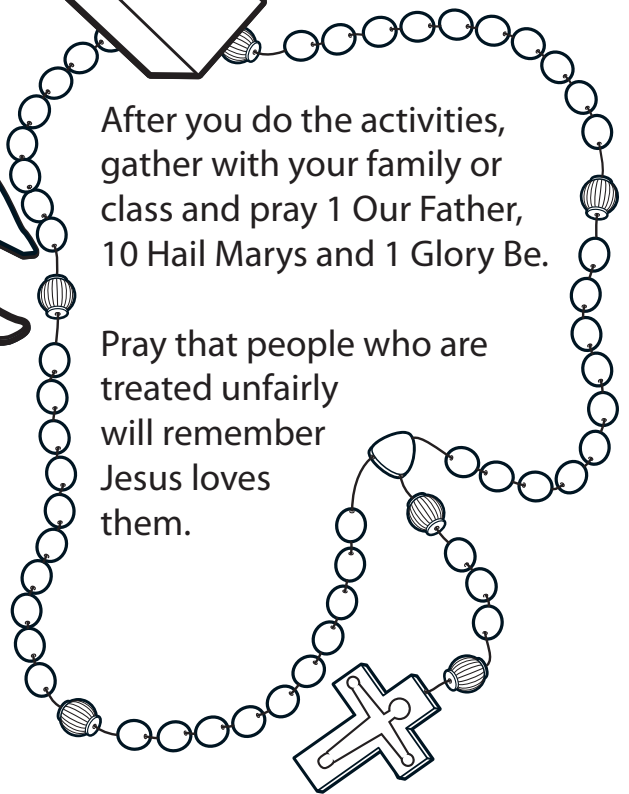

The Our Father Word Search

Find the words that are in the Our Father. Once you find them all, pray the Our Father.

KINGDOM

FORGIVE

HEAVEN

BREAD

AMEN

EARTH

FATHER

NAME

G Z F Y M F X U J S Q Q W
I K A H U O V A H A U K M
M X T N L R S P Q X Y E P
H E H Y U G N X A I M A U
Z F E K Z I M T F H D R G
L P R A E V E S R E L T K
B S L D Z E V Y J A W H K
D N A M E R P Q G V D Q I
U H D H W A M E N E X S N
Q D J U B R M I C N E E G
B R E A D E F N B O Y H D
W H G Q E Y S Z C C T R O
Z K D L U D C E T U M R M



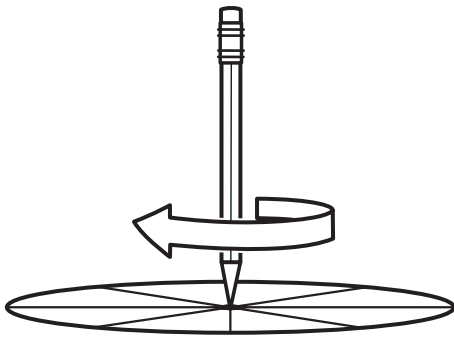



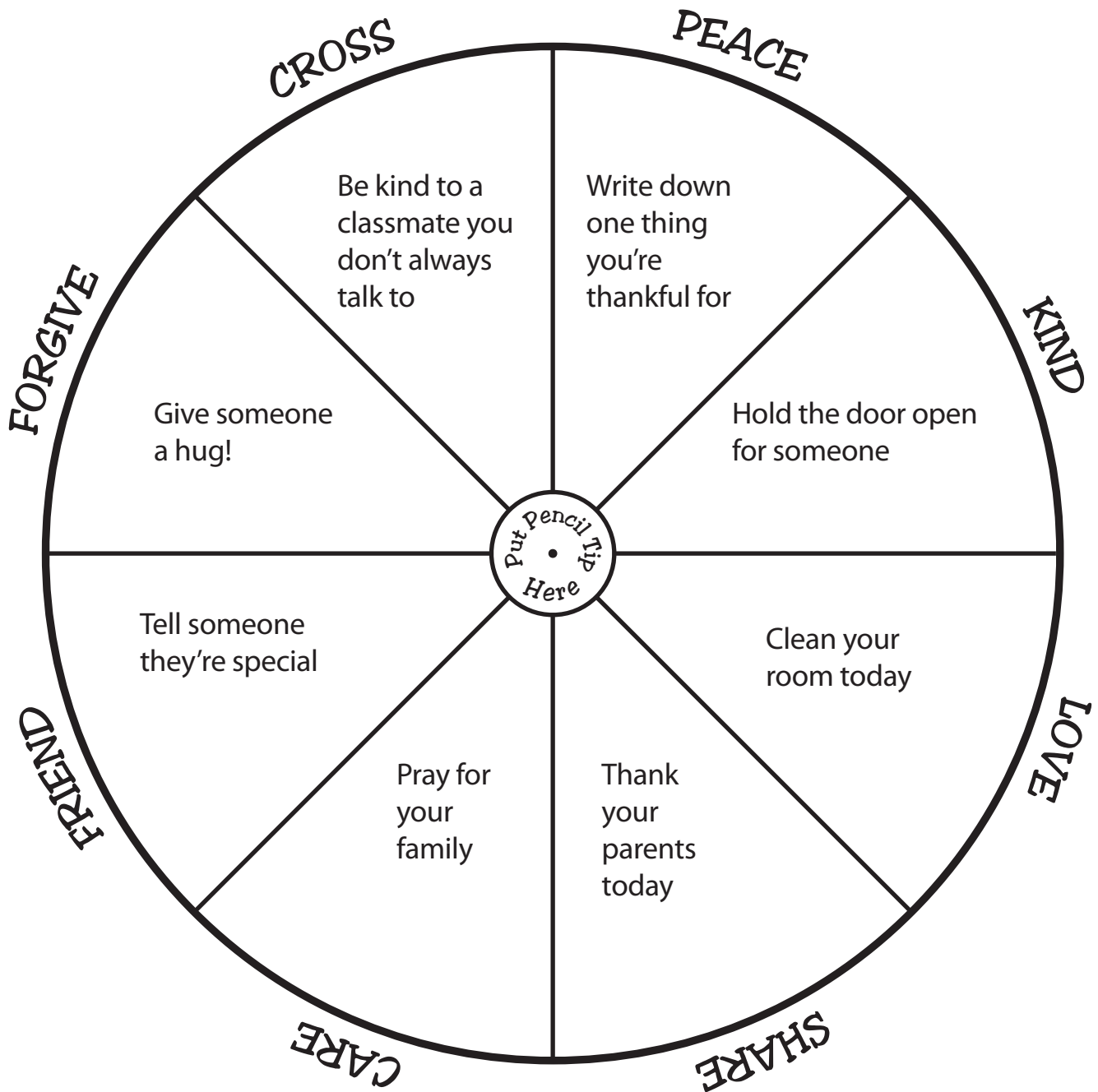





Spin Game



Spin each day to make peace a new way! With help from your family, make a spinner with a paperclip and pencil. Place the paperclip in the center of the circle and put the tip of your pencil in the opening of one end of the clip to hold it in place. Spin the clip and watch it stop on an action. Once you do the action, tell your family about the peace it brings you and others.



Find Peace

	P			E	
		A			C
			E		

Cross out all of the squares that have shapes in them and you will find peace.

List three ways you can make peace in your home:

1. _____
2. _____
3. _____

Tell your parents about it!



The Carrying of the Cross

The Fourth Sorrowful Mystery

Read this story in the Bible –
Matthew 27:32

After you do the activities,
gather with your family or
class and pray 1 Our Father,
10 Hail Marys and 1 Glory Be.

Pray for those who carry
heavy burdens
and feel
overwhelmed.

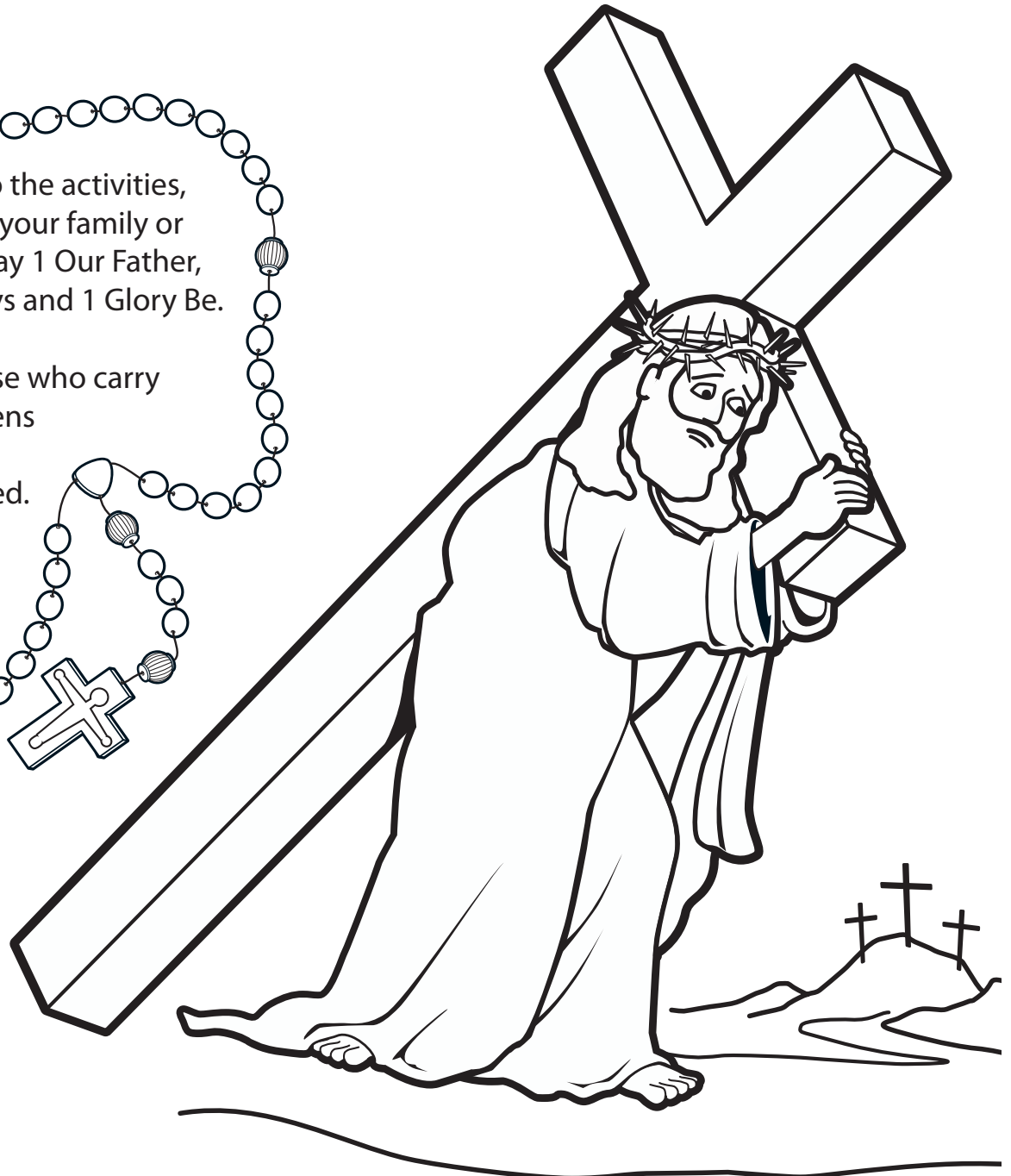
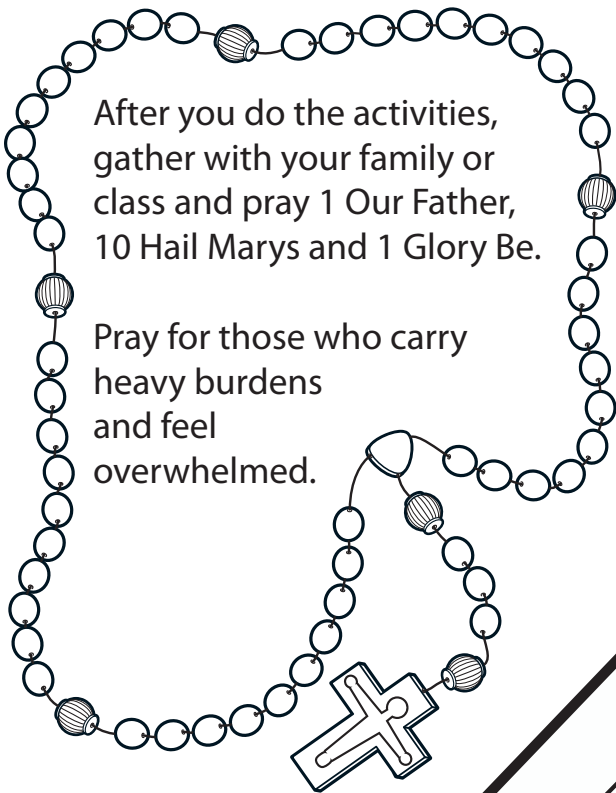

Help Simon to quickly find Jesus!

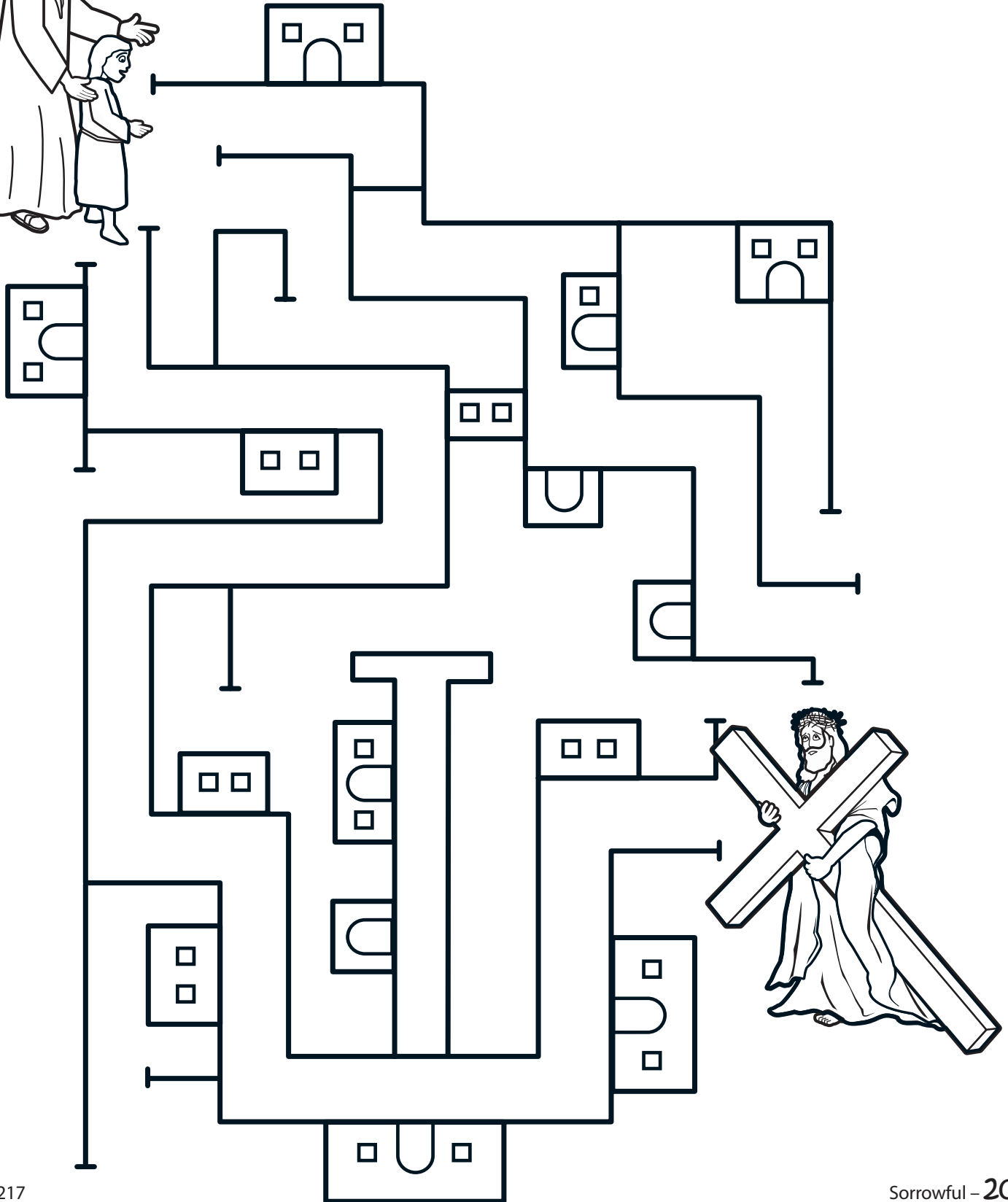

Connect the dots and color

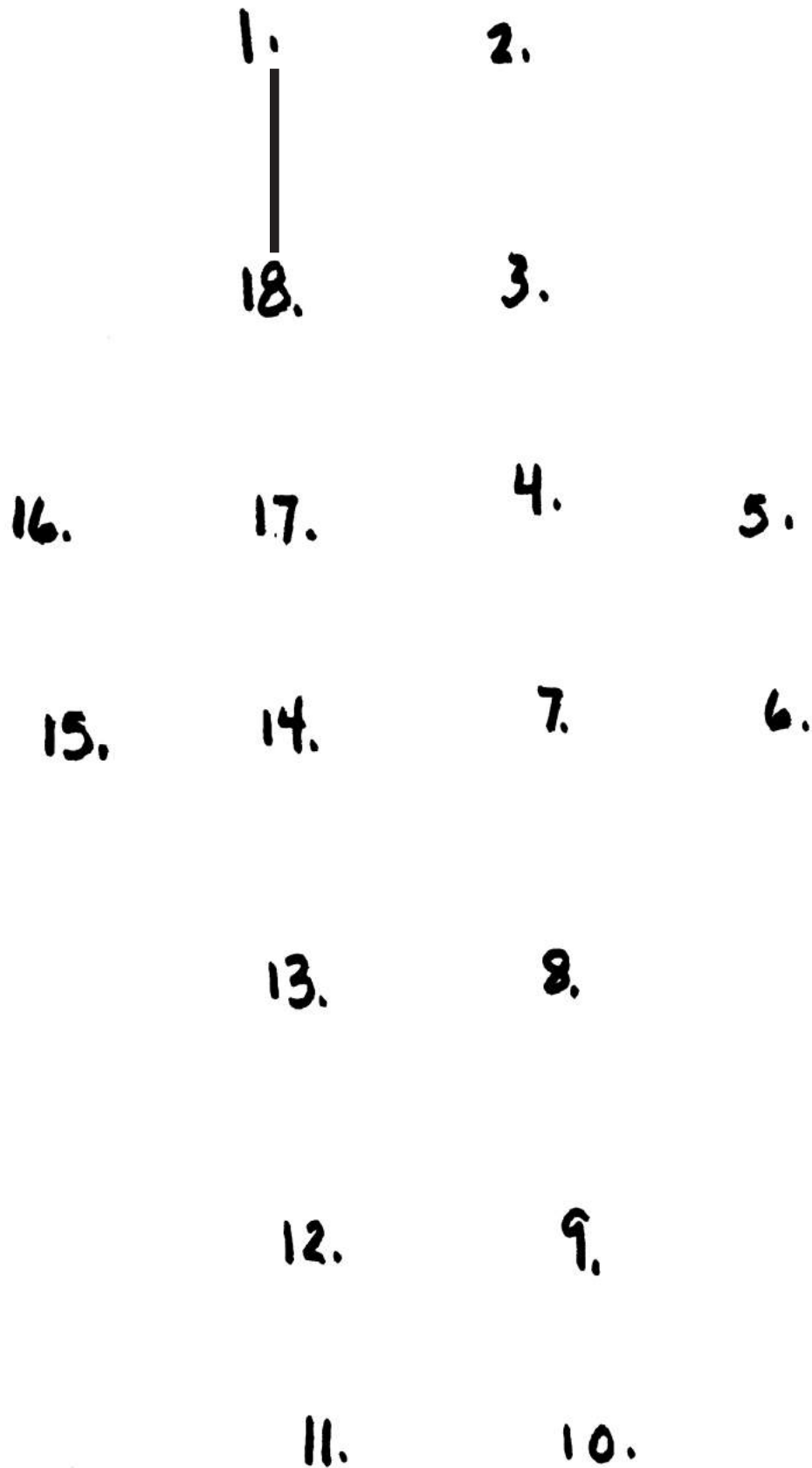

Helping Others

It's so important that we pitch in and help the people around us.
We all need help sometimes!

Make a list of 5 ways you can help someone:

1. _____
2. _____
3. _____
4. _____
5. _____

Now pick one to do this week!

Here are some ideas:

- ☺ Help your parents with house chores
- ☺ Pray for someone you know is upset
- ☺ Volunteer to help your neighbor



The Crucifixion

The Fifth Sorrowful Mystery

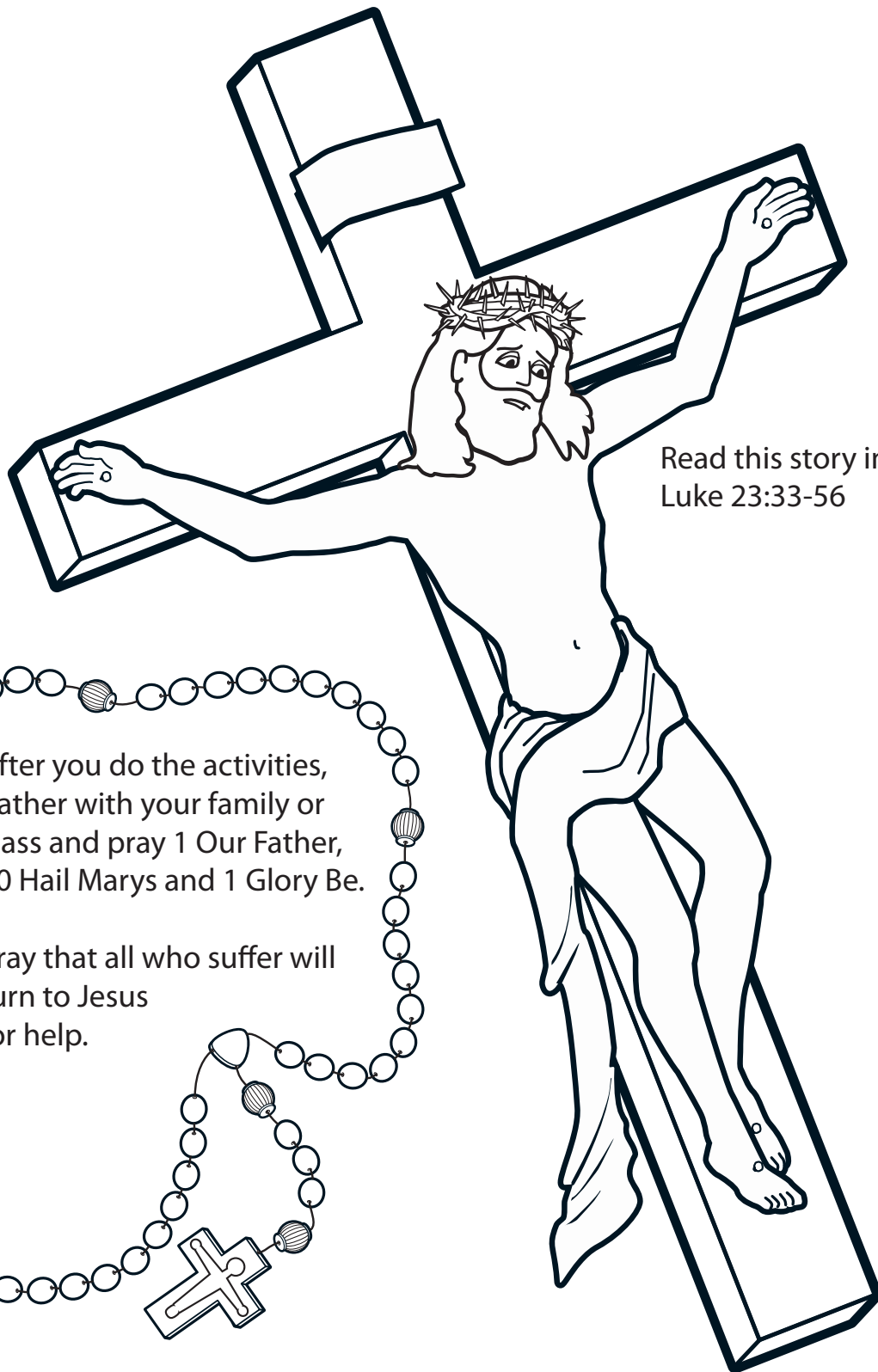

Read this story in the Bible –
Luke 23:33-56

After you do the activities,
gather with your family or
class and pray 1 Our Father,
10 Hail Marys and 1 Glory Be.

Pray that all who suffer will
turn to Jesus
for help.

I can make the Sign of the Cross



1. In the name of the Father



2. And the Son



3. And the Holy Spirit

4. Amen.

1. Yellow 2. Blue 3. Green 4. Red

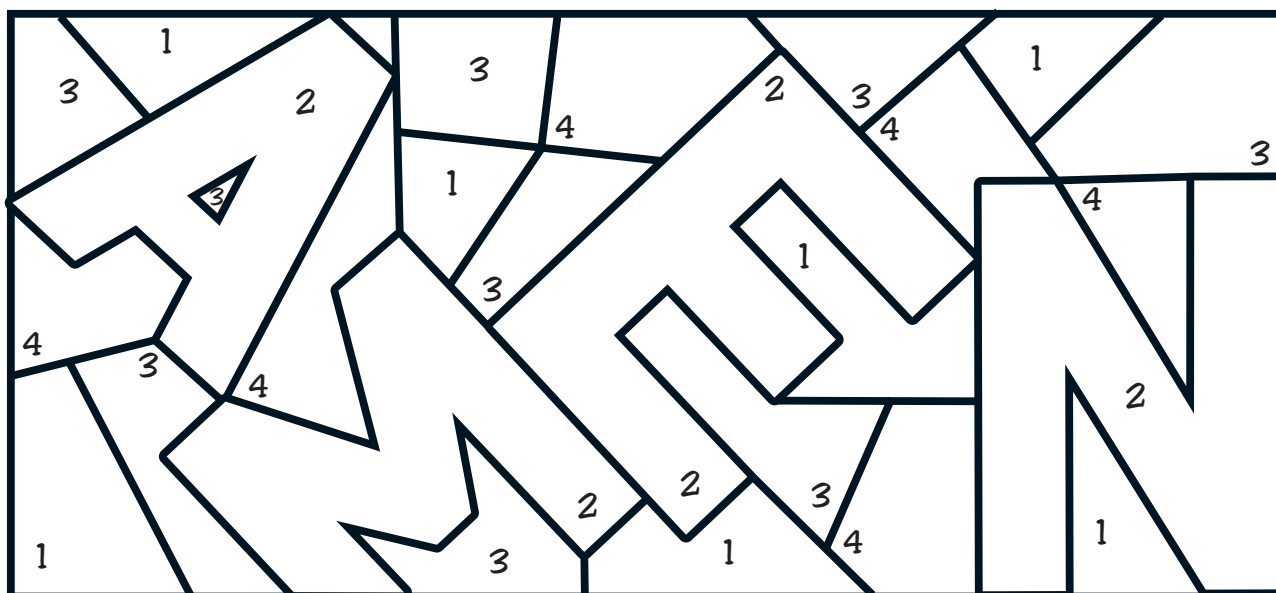

The Crucifixion Word Search Puzzle

Find the underlined words in the word search puzzle below:

Jesus died on the cross.

Jesus died on Good Friday.

Jesus died on the cross to forgive our sins.

Jesus' mother Mary stood at the bottom of the cross.

Jesus asked His disciple John to take care of his mother.

Jesus prayed to God to forgive the people who crucified him.

Y	F	F	R	R	O	H	O	N	J	I	C	D
G	D	H	H	F	H	F	F	N	M	A	R	Y
O	F	O	Z	L	O	G	L	C	Q	S	K	M
O	U	D	N	M	W	C	S	Q	Z	N	G	N
D	O	A	J	O	H	N	S	P	J	Y	B	Y
F	M	W	S	V	W	D	T	J	Y	D	A	U
R	V	L	U	S	M	K	D	K	H	X	L	K
I	V	V	W	I	H	F	H	C	I	Q	Y	Y
D	D	Z	S	N	Y	F	O	R	G	I	V	E
A	A	U	A	S	M	Z	N	O	C	T	H	Y
Y	K	B	H	P	F	N	M	S	D	T	U	S
Z	O	P	T	R	Q	T	C	S	B	O	D	L
Z	F	N	S	A	E	M	P	D	O	V	S	W

The Cross

When we see a cross, we think about Jesus, what He did for us, His love and His promises.

What is missing from the Rosary below? Draw what's missing to make the Rosary complete.

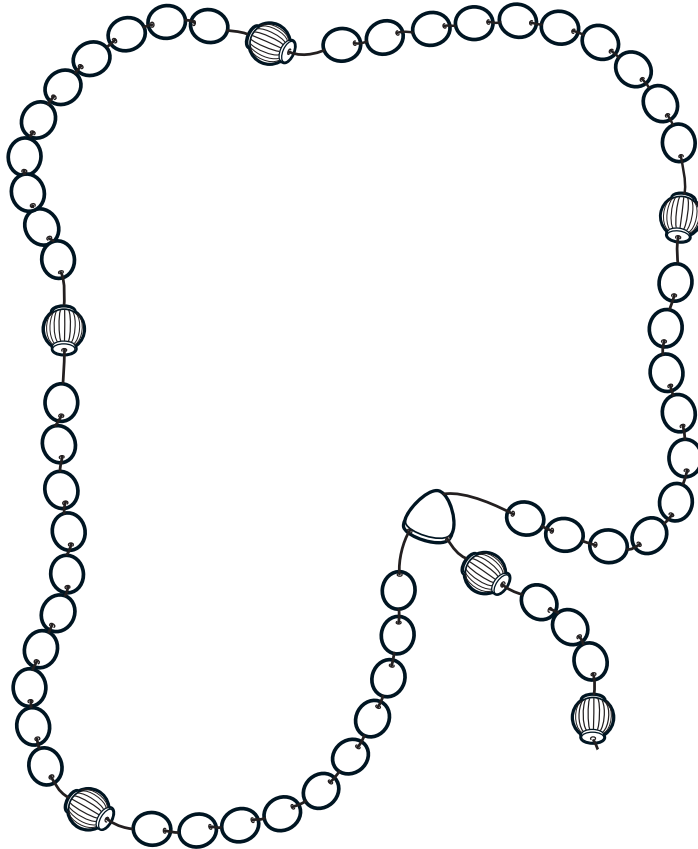

Do you have a cross in your house to remind you of Jesus? Yes No

Where is it? _____

Can you make a cross out of paper to hang in your room?

Can you find other cross shapes in your home? Ask your family to help you look.