

Aesculap Surgical Instruments

General Catalog

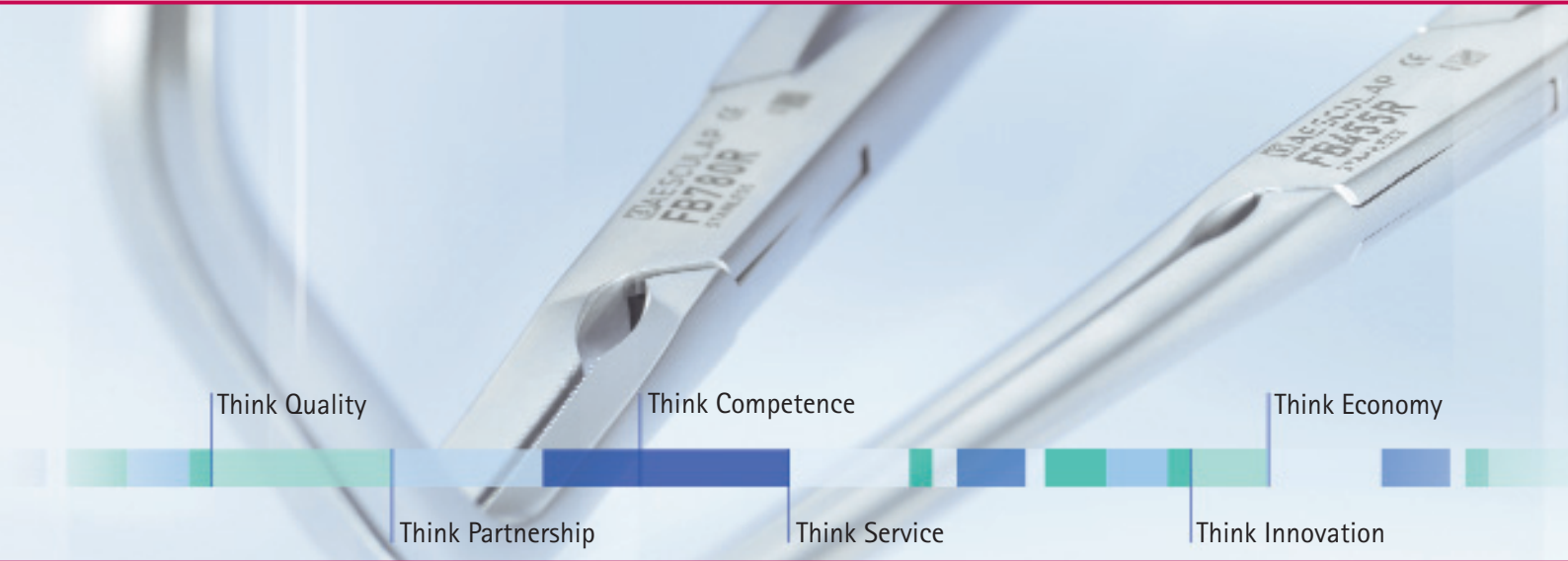

Think Surgical Instruments. Think Aesculap.

Think Aesculap.

Profundes Wissen setzt die Vernetzung von Kenntnissen und Erfahrungen sowie deren folgerichtige Bewertung voraus. Ein Prinzip, dem B. Braun seit über 160 Jahren konsequent folgt und welches sich daher auch in der Aussage „Sharing Expertise“ ausdrücklich widerspiegelt. Ein Wissensaustausch über alle Sparten des Konzerns hinweg schafft eine breitere und somit fundiertere Wissensbasis für alle Beteiligten. Das Ergebnis sind bis ins Detail durchdachte, weitsichtige Lösungen und ein Höchstmaß an Sicherheit. Zum Wohl des Patienten und im Interesse der Anwender.

Mit über 130 Jahren Erfahrung im Segment der chirurgischen Instrumente ist die Sparte Aesculap kompetenter Partner für den interdisziplinären Wissensaustausch.

Die Produktmarke Aesculap steht für ein vielfältiges Leistungsspektrum, das hochwertige Produkte mit prozessorientierten Dienstleistungen intelligent und im Sinne der Wirtschaftlichkeit verknüpft. Aesculap ist ein verlässlicher und akzeptierter Partner für den gesamten chirurgischen Prozessablauf in der Klinik.

Dass Aesculap zu den Besten der Branche gehört, verdankt das Unternehmen seinen Mitarbeiterinnen und Mitarbeitern, die sich auf der Suche nach der bestmöglichen Lösung nie mit der ersten Idee zufrieden geben. Menschen, die jede Entwicklung immer wieder prüfen, hinterfragen und optimieren.

Deshalb ist Aesculap weit mehr als ein Lieferant hochpräziser chirurgischer Instrumente: ein Partner, der genau zuhört und mitdenkt, die Bedürfnisse und Anforderungen seiner Kunden versteht und sie auf hohem Niveau versorgt. Vom Produkt über Dienstleistungen und Seminare für alle Funktionsbereiche.



Think Quality

Think Partnership



- Bei Verträgen halte ich es wie in einer Partnerschaft: gegenseitiges Vertrauen und Wertschätzung sind die Basis.

Think Partnership. Think Aesculap.

Think Competence



- Das Informations- und Beratungszentrum in Tuttlingen ist weltweit einmalig. An keinem anderen Ort könnte ich so überzeugend und mit einer solchen Auswahl beraten!

Think Competence. Think Aesculap.



- || Unsere Instrumente werden von Chirurgen auf der ganzen Welt geschätzt. Ich weiß, warum das so ist und Sorge dafür, dass es so bleibt.

Think Quality. Think Aesculap.

- || Am Anfang sind meine Gesprächspartner manchmal skeptisch: hohe Qualität und trotzdem eine wirtschaftlich sinnvolle Lösung? Dann lasse ich einfach Fakten sprechen.

Think Economy. Think Aesculap.



Think Economy

Think Service



- || Manchmal sorgen wir auch mit Kleinigkeiten für einen reibungslosen Prozess. Hauptsache alles läuft und alle sind zufrieden.

Think Service. Think Aesculap.

Think Innovation



- || Jedes neue Produkt ist wie ein eigenes Baby. Man kümmert sich liebevoll darum, bis es irgendwann das Haus verlässt.

Think Innovation. Think Aesculap.

Think Quality. Think Aesculap.

Um den eigenen hohen Ansprüchen und den Erwartungen der Anwender in allen Bereichen gerecht zu werden, sind auch die Aesculap Qualitätsanforderungen außerordentlich hoch. Bei mehr als 17.000 Produkten, die nahezu alle Indikationen der einzelnen Fachbereiche abdecken, kein einfaches Unterfangen.

Von vornherein hat man sich daher eine eigene Qualitätsnorm auferlegt, die die erlaubten DIN/ISO Standard-Toleranzen in jeder Hinsicht stark begrenzt. Das macht sich bereits bei der Auswahl und Prüfung der Werkstoffe bemerkbar und setzt sich über den gesamten Fertigungsprozess fort.

Die auf einer Symbiose aus Hightech und Handarbeit basierende Herstellungstechnik der Instrumente sowie eine hohe Fertigungstiefe ermöglichen Modelltreue und höchste Präzision in stets gleichbleibender Qualität.

Bei Aesculap weiß man schließlich seit über 130 Jahren, dass es nichts Wirtschaftlicheres gibt, als eine hohe Qualität.



■ Qualitätssicherung

Ein wesentlicher Bestandteil des umfangreichen Qualitätsmanagementsystems ist der integrierte Ablauf von der Produktidee, über die Entwicklung, die Produktion bis zum geprüften fertigen Instrument. Dies beinhaltet moderne Fertigungsverfahren und gesicherte Prozessabläufe inklusive systematischer Qualitätskontrollen, um die konstant hohe Aesculap Qualität zu sichern.





■ Nur mit dem Know-how, der Erfahrung und Sorgfalt der Aesculap Chirurgiemechaniker lässt sich reproduzierbare Aesculap Qualität über Jahrzehnte hinaus garantieren. Wissen, das man verantwortungsvoll weitergibt.



Hartmetall-Instrumente

Bei Instrumenten mit Hartmetall-Einlagen verwenden wir nur hochwertige nickelgebundene Hartmetall-Plättchen, die sich durch eine hohe Korrosionsbeständigkeit und einen geringen Verschleiß auszeichnen.



Arterienklemme – Olive im Maulbereich

Die Olive bildet den Übergang vom Arbeitsende zum „Schluss“ des Instrumentes. Durch diese besondere Anatomie wird das Maul elastischer und das Instrument weniger bruchanfällig.



Wie wir erreichen, dass jedes Aesculap Instrument präzise den Formen und Abmessungen des Masters entspricht? Wir kontrollieren jedes einzelne Instrument!

Think Innovation. Think Aesculap.

Im kontinuierlichen Dialog mit Praktikern und klinischen Partnern entwickelt und realisiert Aesculap Instrumente für alle chirurgischen Disziplinen – nicht selten mit Vorbildcharakter. Weltweit arbeitet ein Team von etwa 200 Mitarbeitern im Bereich Forschung und Entwicklung an neuen, wirtschaftlich tragbaren Lösungen im Sinne einer bestmöglichen Patientenversorgung.

Nicht das technologisch Machbare, sondern das medizinisch Sinnvolle steht dabei grundsätzlich im Mittelpunkt.

Sinnvolle Entwicklungen bedeuten für uns, den Verlauf eines chirurgischen Eingriffs durch die Funktionalität des eingesetzten Instrumentariums unter wirtschaftlichen Gesichtspunkten entscheidend positiv zu beeinflussen, wie zum Beispiel:



BipoJet

Bipolare Präparierschere für die offene Chirurgie

BipoJet ermöglicht Präparieren, mechanisches Schneiden und Koagulieren in einem Arbeitsgang. Dies bedeutet für den Chirurgen, dass er mit BipoJet noch schneller, sicherer und effizienter arbeiten kann. Neuartige Fertigungstechnologien wie der solide Keramikeinsatz im Scherenblatt sowie eine PEEK-Kunststoffbeschichtung stehen für die Langlebigkeit und elektrische Sicherheit. Für die Klinik bedeuten Effizienz, Sicherheit und Langlebigkeit einen wichtigen wirtschaftlichen Vorteil.



Retraktionssystem Münster

Das Retraktionssystem Münster, mittlerweile ein Synonym für Variabilität, Flexibilität und Stabilität in der Abdominalchirurgie, wurde in seiner Weiterentwicklung durch einen neuen offenen Rahmen ergänzt. Dieser ist durch eine neuartige Gelenktechnologie stufenlos in drei Ebenen leicht und schnell verstellbar. Für den Anwender bedeutet dies noch mehr Freiraum und Anpassungsfähigkeit des Systems an die individuelle OP-Situation.



Mikro-Instrumente

für die Herz- und Gefäßchirurgie

Hergestellt mit modernsten Fertigungstechnologien aus ausgewählten Materialien für ausgezeichnete Funktionalität. Die Arbeitsflächen der Maulteile von Nadelhaltern und Pinzetten sind mit der Aesculap DIADUST Diamantstaub-Beschichtung versehen. Das Ergebnis: eine harte Arbeitsfläche mit hoher Verschleißfestigkeit. Darüber hinaus bietet DIADUST-Beschichtung ein zuverlässiges Fassen von feinen Nadeln sowie von Weichgewebe.

Gemeinschaftsentwicklung



Bei der Neu- und Weiterentwicklung von chirurgischen Instrumenten arbeitet Aesculap eng mit den Anwendern zusammen. So entstehen hochwertige Produkte, die Maßstäbe setzen und bis ins Detail den Wünschen und Anforderungen des Chirurgen entsprechen.

Aus dieser Kooperation zwischen Aesculap Spezialisten und erfahrenen Anwendern erwachsen wertvolle Synergie-Effekte und außergewöhnliche Projekte, die immer wieder maßgebliche Innovationen im Bereich der chirurgischen Instrumente hervorbringen.

Ein straff konzipiertes Projektmanagementsystem sorgt zudem für Transparenz und Effizienz der Aesculap Entwicklungsprojekte.

BipoJet – ein Beispiel aus der Praxis



Prof. Dr. med. Gottfried Müller ist Chefarzt der Chirurgischen Klinik im Caritas-Krankenhaus Bad Mergentheim und seit über 20 Jahren maßgeblich in die Entwicklung von Aesculap chirurgischen Instrumenten involviert.

„Eine über 20-jährige erfolgreiche und angenehme Zusammenarbeit mit Aesculap an einer Vielzahl von Projektideen bedeutet für mich freundschaftliches und vertrauensvolles Zuhören, fachlich fundiertes Diskutieren, exaktes Recherchieren und Programmieren von Projekten in Untertiteln: Innovation, Sinnhaftigkeit, Markterwartung, Funktion, Ergonomie, Material, Qualität, Fertigung, Recherche, Überprüfung, Funktionalität, Sicherheit, Zuverlässigkeit, klinische Kontrolle, Praktikabilität, Wirtschaftlichkeit, Systemtauglichkeit und Marktverträglichkeit. All diese Schlagworte stehen hinter Projekten, die für mich interessant waren und sind.

Aesculap bedeutet für mich aber auch die persönliche Verbindung mit interessanten Menschen, die ihre Erfahrung und

Kraft in viele Kontakte einbringen, wie Ingenieure, Mechaniker, Sekretärinnen, Betriebswirte, Mediziner und Entwickler, viele kreative Frauen und Männer aller Berufsklassen.

Aesculap zu kennen heißt für mich, Einblick in eine große seriöse Einheit zu haben, deren Aufgabe es ist, Produkte für die Medizin zu liefern – also Dinge, die mit uns Chirurgen direkt zu tun haben. Aesculap ist vor diesem Hintergrund für jeden Chirurg ein Begriff. Dahinter stehen für mich Menschen am Schreibtisch und am Schraubstock, die sich mit allem Einsatz für Projekte in Zusammenarbeit zur Verfügung stellen, Projekte, die meine medizinische Zukunft mitbestimmen.

Jüngstes Beispiel hierfür ist die gemeinsame Entwicklung von BipoJet.“

Dr. med. Albert Linder ist Chefarzt der Abteilung Thorax-Chirurgie an der Lungenklinik Hemer und von der Idee „aus der Praxis für die Praxis“ überzeugt. Herr Dr. Linder arbeitet seit mehr als 10 Jahren als klinischer Berater eng mit Aesculap zusammen.

„Die Entwicklung der BipoJet-Schere ist ein hervorragendes Beispiel dafür, wie Anwenderideen aus der täglichen Arbeit im OP in kurzer Zeit zu einem marktreifen High-Tech-Produkt werden können. Bei Aesculap geschieht das in ausgezeichneter Kooperation zwischen Chirurg und Entwicklungsteam und immer vor Ort, mal im OP, mal in der Werkstatt.“





Projektberatung mit allen Funktionsbereichen der Klinik im Informations- und Beratungszentrum (IBZ) in Tuttlingen.

Durch stetige Veränderungen im Gesundheitsmarkt, der Einführung der DRGs sowie des Total Quality Managements gewinnt das Thema „Investition in chirurgische Techniken“ enorm an Brisanz – und etwaige Fehlentscheidungen lassen sich im Nachhinein nur schwer korrigieren.

Das Team der Aesculap Projektplanung, Fachleute mit Know-how und operationellem Sachverstand, unterstützt Krankenhäuser und Kliniken bei der Planung kleiner und großer Projekte und setzt sie routiniert, zeitnah und zuverlässig um. Weltweit.

Das Team kooperiert mit Architekten, Technikern, Ärzten, Pflegepersonal und Verwaltung, analysiert Abläufe, ermittelt Bedarfe und schafft die Voraussetzung für optimierte Prozesse. Das Ergebnis ist eine fundierte Projektierung, die von A bis Z funktioniert. Ob Neubau einer Klinik oder Aufbau einer neuen Disziplin.

■ Hospitationen

Vor einer geplanten Investition steht man immer einer Vielzahl von Fragen und Entscheidungen gegenüber, deren konkrete Beurteilung oftmals erst später möglich ist. Wir haben es uns darum zur obersten Devise gemacht, Ihnen ein Höchstmaß an Entscheidungssicherheit mit auf den Weg zu geben. Aus diesem Grund bieten wir unseren Gesprächspartnern die Möglichkeit, sich neben unserer umfassenden Beratung in Tuttlingen auch in Form einer Hospitation ein genaues Bild unserer Leistungen zu machen und sich mit Kollegen in anderen Kliniken fachspezifisch über alle Funktionsbereiche hinweg auszutauschen. Soviel Sicherheit muss sein.



Planung & Beratung – ein Beispiel aus der Praxis

„Bei komplexen Projekten braucht man einen vorausschauenden Partner, der bei Detailfragen das Gesamtkonzept im Auge behält ...“

■ Dipl.-Betriebswirt Dr. Dr. Dirk Knüppel

Anlass der Zusammenarbeit mit Aesculap war der Fachrichtungswechsel zwischen der Klinik Rotes Kreuz und der Klinik Maingau, beides Beleghäuser mit je ca. 30 Operateuren im Raum Frankfurt. Laut Beschluss der Aufsichtsbehörde sollten zum 01. Juli 2003 die Maingauer Orthopäden in die Rotkreuz-Klinik und die Gynäkologen sowie Urologen in die Klinik Maingau wechseln. Ziel war eine Straffung der Disziplinen je Standort – eine Forderung der Kostenträger, die beinhaltet, dass die gleichen Fachbereiche nicht mehr in beiden Kliniken vorgehalten werden dürfen. Zeitgleich mit dem Umzug stand die Eröffnung des neuen OP- und Funktionstraktes mit angegliederter ZSVA in der Rotkreuz-Klinik an.

Ein komplexes Projekt also, das die externe Unterstützung eines erfahrenen Beraters erforderlich machte. Für die Umsetzung wünschten wir uns einen vorausschauenden Partner, der auch bei Detailfragen das Gesamtkonzept im Auge behält. So kam es zu Beginn des Jahres 2002 zu ersten Gesprächen mit einem Aesculap Mitarbeiter bezüglich des anstehenden Projekts. Gemeinsam wurde zunächst das Dienstleistungsangebot von Aesculap geprüft und dann die weiteren Schritte beschlossen. Für Transparenz und Sicherheit sorgte von Beginn an ein detaillierter Liefer- und Dienstleistungsvertrag, der alle Bestandteile der Service-Leistungen von der Neulieferung der Instrumente, über die Sanierung und den Werterhalt bis hin zur Installierung von instacount®PLUS im Rahmen eines „Worst-Case-Szenarios“ enthielt. Darüber hinaus war die Bedarfs- und Kostenschätzung durch Aesculap eine wertvolle Grundlage für die Budgetplanung der Kliniken.

Beratungsbasis war eine Bestandsanalyse beider Kliniken, deren Ergebnis im Kreise der Pflegedienst- und OP-Leitungen sowie der Hygiene und der Geschäftsleitung beider Kliniken präsentiert wurde. Vor diesem

Hintergrund unterteilte Aesculap die Instrumente in beiden Häusern zunächst in drei Kategorien: veraltet (hoher Anteil an Korrosionen), reparaturbedürftig, und ohne Einschränkung wieder verwendbar. Die Reparatur und Aufbereitung älterer Instrumente wurde in Etappen organisiert, um Beeinträchtigungen im laufenden Betrieb weitestgehend zu vermeiden. Im Anschluss erfolgte die Errechnung des voraussichtlichen Zusatzbedarfes an Instrumenten und Geräten in Abstimmung zwischen Aesculap und den OP-Leitungen. Dieser Mehrbedarf resultierte einerseits aus dem Fachrichtungswechsel, um bei parallel laufenden OPs einer Disziplin genügend Instrumentarium zur Verfügung zu haben und andererseits aus dem Anspruch, innerhalb der neuen, qualitativ verbesserten ZSVA einen reibungslosen und sicheren Ablauf zu gewährleisten. Im nächsten Schritt wurden direkt am Aesculap Standort in Tuttlingen die benötigten Instrumente ausgesucht und eine neue Sieb- und Containerstruktur entwickelt, die den Bedarf beider Häuser berücksichtigt und im gleichen Zuge die teure Vorhaltung nicht benötigter Instrumente ausschließt.

„Das A und O ist eine wirtschaftliche Zusammensetzung – so viel wie nötig, so wenig wie möglich.“

Bereits in dieser Phase des Projekts wurden die positiven Effekte der Beratung durch Aesculap bei allen Beteiligten deutlich: Durch die frühzeitige Planung im Vorfeld konnten zeitliche und strukturelle Engpässe weitestgehend vermieden werden und das ohnehin verstärkt beanspruchte Personal wurde durch den Aesculap Beratungsservice während der gesamten Umstrukturierungsphase optimal entlastet. Durch die Sieb- und Containeroptimierung

Dipl.-Betw. Dr. Dr. Dirk Knüppel, Direktionsassistent der Frankfurter Rotkreuz-Krankenhäuser e. V. und Projekt-Verantwortlicher, über den Aesculap Planungs- und Beratungsservice im Rahmen des Großprojekts „Fachrichtungswechsel und OP-Neubau am RKH Frankfurt“

wurden zudem überflüssige Vorhaltekosten vermieden und die Abläufe gewannen in hohem Maße an Wirtschaftlichkeit.

Beide Kliniken haben durch den Fachrichtungswechsel ein schärferes Profil mit eindeutigen Schwerpunkten erhalten, was zu höheren Fallzahlen und einer besseren Spezialisierung führte. Die gemeinsam mit Aesculap realisierte Prozessoptimierung und Standardisierung hat hier mittelfristig zu merklichen Kosteneinsparungen geführt und spiegelt unseren Gesamtanspruch wieder, bei kalkulierbaren Kosten eine bestmögliche Behandlungsqualität anzubieten. Die Umstrukturierung in Verbindung mit dem Planungs- und Beratungsservice von Aesculap hat zudem die Anpassung an DRG-Bedingungen bei gleichzeitiger Qualitätssteigerung unterstützt.

Da alle Entscheidungen in enger Abstimmung zwischen Aesculap und den Verantwortlichen in den Kliniken getroffen wurden, gab es trotz der Komplexität des Projekts keine Informationsdefizite oder zeitlichen Verzögerungen. Umzug und Eröffnung des OP-Traktes fanden pünktlich am 1. Juli 2003 statt, wobei hervorgehoben werden sollte, dass der Aesculap Mitarbeiter hier nicht nur als Berater, sondern auch tatkräftig im wahrsten Sinne des Wortes zur Verfügung stand.



Think Economy. Think Aesculap.



Effizient arbeitet nur derjenige, der den Überblick über sein Instrumentarium behält. Einsparungen sind nur dann sinnvoll realisierbar, wenn man seinen Bestand kennt und ihn konsequent organisiert. Aber wer soll sich im Tagesgeschäft darum kümmern?

Mit der Bestandsanalyse übernimmt Aesculap als spezialisierter Dienstleister die quantitative Erfassung und qualitative Analyse des kompletten Instrumentariums – über alle Disziplinen und Produktlieferanten hinweg. Das Ergebnis ist eine objektive, detaillierte und aktuelle Dokumentation der Bestände inklusive des Wartungs-, Reparatur- und Beschaffungsbedarfs sowie der damit verbundenen Kosten.

Mit der folgenden Sieboptimierung wird der Bestand vor Ort exakt an die spezifischen Anforderungen von Indikationen und OP-Techniken angepasst. Diesem Schritt geht in der Regel ein Besuch aller Funktionsbereiche im Informations- und Beratungszentrum (IBZ) in Tuttlingen voraus. Es werden Arbeitsabläufe besprochen, neue Siebstrukturen gemeinsam konzipiert und bei Bedarf neue OP-Techniken erläutert.

Alles in allem trägt dieses Konzept zu größtmöglicher Transparenz bei, verschlankt Abläufe, eröffnet Einsparpotenziale, gibt Investitionssicherheit und ist ein wesentlicher Baustein des Qualitätsmanagements, das Ziel der Prozessoptimierung immer im Blick.



Bestandsanalyse & Sieboptimierung – ein Beispiel aus der Praxis

Chefarzt Prof. Dr. med. Hans-Rudolf Tinneberg, Direktor des Zentrums für Gynäkologie und Geburtshilfe der Justus-Liebig-Universität Gießen und

Otto Armstroff, Abteilungsleiter Technischer Einkauf, über Ablauf und Ergebnis des Aesculap Projekts „Bestandsanalyse und Sieboptimierung in der Frauenklinik der Universität Gießen“.

Prof. Tinneberg

„Durch die Prozessoptimierung haben unsere Mitarbeiter mehr Zeit für das Wesentliche – den Patienten und die Qualität der Behandlung ...“

Erstklassige operative Ergebnisse hängen nicht nur vom Können des Operateurs ab, sondern auch von der Qualität der verwendeten Instrumente und der Zusammenstellung der Siebe. Wir verfügen heute über eine optimal abgestimmte Siebstruktur, die in jeder Hinsicht das operative Spektrum berücksichtigt und gerade unter DRG-Bedingungen in erheblichem Maße zu mehr Wirtschaftlichkeit, einer Straffung der Ablauforganisation und nicht zuletzt zu einer hohen Ergebnisqualität beiträgt.

Die Prozessoptimierung innerhalb der Universitäts-Frauenklinik ist u.a. das Resultat einer Bestandsanalyse und Sieboptimierung, mit der wir Aesculap im Herbst 2002, nach meiner Übernahme des Direktorats der Frauenklinik, beauftragten. Mit dem Stellenwechsel kam es zu einer Verlagerung der Schwerpunkte und somit zu einer intensiveren Hinwendung zur operativen Gynäkologie. Der tägliche Umgang mit den eigenen Instrumenten war geprägt von Unzufriedenheit, so dass gemeinsam mit der Verwaltung beschlossen wurde, hier grundlegende Veränderungen vorzunehmen. Aesculap war bereits an den ersten Gesprächen beteiligt und überzeugte alle

Beteiligten mit dem Konzept einer Bestandsanalyse mit anschließender Sieboptimierung. Die Bestandsanalyse wurde von zwei speziell ausgebildeten Aesculap Mitarbeitern durchgeführt und umfasste das gesamte operative Instrumentarium. Es wurde eine detaillierte Liste aller vorhandenen Instrumente erstellt, die sowohl quantitativ für Transparenz über die Produktbestände sorgte als auch qualitativ den Zustand der Instrumente bezüglich der Abnutzung und des Wartungs- bzw. Reparaturbedarfs dokumentierte. Im Anschluss folgte auf Basis dieses Gutachtens die Analyse des Gesamtwertes sowie der Aufarbeitungs- und Ersatzbeschaffungskosten.

Nachdem nur ein geringer Prozentsatz der vorhandenen Instrumente durch Reparatur weiterhin verwendbar war, wurde mit Aesculap eine komplette Neuzusammenstellung der Siebe vereinbart. Ausgesprochen konstruktiv verlief der Besuch der Operateure bei Aesculap in

Tuttlingen. Hier konnten wir punktgenau auf unseren Bedarf abgestimmte Instrumente auswählen und zudem sogar nach unseren Wünschen speziell angefertigtes Instrumentarium bestellen. Die Siebstruktur wurde komplett überarbeitet und dem OP-Spektrum der Frauenklinik angepasst. Unübersichtliche Siebe wurden in Abstimmung mit den OP-Leitungen aufgeteilt, und Instrumente, die aufgrund veränderter OP-Techniken nicht mehr benötigt wurden, konnten aussortiert werden. Dies führt insgesamt zu einer Qualitätssteigerung, deren Niveau aufgrund eines mit Aesculap abgeschlossenen Wartungsvertrages auch mittel- und langfristig gewährleistet ist. So haben wir die Sicherheit, dass uns für anspruchsvolle Operationen jederzeit ein hochwertiges und präzises Instrumentarium zur Verfügung steht.

Die Mitarbeiter im OP profitieren von der Sieboptimierung in hohem Maße, da durch die erhöhte Übersichtlichkeit die Fehlerquote der ZSVA deutlich verringert werden konnte und durch die Verschlankeung der Abläufe mehr Zeit bleibt für das Wesentliche: den Patienten und die Qualität der Behandlung. Darüber hinaus ist auch die Verringerung der körperlichen Belastung durch Einhaltung der Sieb- und Beladegewichte nicht zu unterschätzen. Eine erhöhte Mitarbeitermotivation wurde zusätzlich durch die Schulungen erreicht, die Aesculap hier vor Ort während des Projekts durchgeführt hat. Ziel war es, die Mitarbeiter in Umgang und Pflege der Instrumente zu schulen aber auch die Bezeichnungen der Instrumente nach Autoren (Langenbeck-Haken, Metzzenbaumschere etc.) für alle verständlich zu machen und dies in den täglichen

„Wir haben die Sicherheit, dass uns für anspruchsvolle Operationen jederzeit ein hochwertiges und präzises Instrumentarium zur Verfügung steht ...“

Arbeitsprozess einfließen zu lassen. Darüber hinaus wurde eine Schulung für alle Ärzte veranstaltet, bei der Aesculap die Zusammensetzung der neuen Siebstruktur (Set-System mit zum Teil abteilungsübergreifenden Grund- und Zusatzsieben) nochmals umfassend erläuterte.

Als äußerst positiv in der Zusammenarbeit mit Aesculap ist schließlich herauszustellen, dass die Beratung zu jeder Zeit sachorientiert und nicht profitgesteuert war und ist.



Der von den Aesculap Beratern erarbeitete ausführliche Bericht der Bestandsanalyse wird auf Wunsch den verschiedenen Zuständigkeitsbereichen in der Klinik präsentiert. Gemeinsam werden die Möglichkeiten zum weiteren Vorgehen erörtert.

Otto Armstroff

Aus der Sicht des Einkaufsleiters spielen Qualitätsaspekte ebenso eine Rolle wie wirtschaftliche Überlegungen. Das hat aber mit kurzfristigen Kosteneinsparungen nicht viel zu tun. Bezogen auf eine umfassende Bestandsanalyse und Sieboptimierung bedeutet das, vorausschauend zu planen und vor allem Komplexitäten weitestgehend zu reduzieren.

Berücksichtigt wurde bei diesem Projekt beispielsweise auch die Umstellung von einer dezentralen zu einer zentralen Sterilversorgungsabteilung innerhalb des Klinikums; hier konnten Aufbereitungskapazitäten nachhaltig gesteigert und Kosten gesenkt werden. Zudem wurde eine Verbesserung der ZSVA-Durchlaufzeiten erreicht, da sich durch die Homogenisierung der Siebinhalte und die wirtschaftliche Struktur der Siebe auch die Packzeiten verkürzten. Durch die

konsequente Auslagerung der Aufbereitung konnten diese Tätigkeiten zudem auf den Bereich der ZSVA konzentriert werden und das Personal innerhalb der Abteilung wird zu Gunsten der ihm eigentlich zugeordneten Aufgaben entlastet.

„ Unser Ziel:
Transparenz im Sinne der
Qualitätssicherung und Nutzung
von Einsparpotentialen ... ”

Wirtschaftlich und im Sinne eines professionellen Qualitätsmanagements vorteilhaft ist der Umstand, dass alle unter heutigen Gesichtspunkten als bedenklich geltenden Artikel (verchromt, korrodiert) aus dem Bestand entfernt und gleichzeitig sanierungsfähige Altbestände nach der Reparatur Kosten sparend wieder in die neue Siebstruktur integriert wurden.

Heute verfügen wir über ein einheitliches Sortiment, in dem sich jedes einzelne Instrument durch seine Artikelnummer exakt identifizieren und nachverfolgen lässt – die so geschaffene Transparenz ermöglicht gerade unter DRG-Bedingungen die benötigte Präzision bezüglich der Kosten- und Budgetplanung.

Durch die gute und abteilungsübergreifende Kommunikation zwischen den Projektbeteiligten und Aesculap sowie die professionelle Arbeitsweise des Aesculap Teams vor Ort war ein störungsfreier Verfahrensablauf jederzeit gewährleistet.

Aufgrund dieses positiven Ergebnisses hat der Vorstand des Universitätsklinikums Gießen beschlossen, auch innerhalb der anderen chirurgischen Disziplinen eine Sieboptimierung durch das Aesculap Team vornehmen zu lassen.

Die Vorteile einer Sieboptimierung sind, neben einem Wissenstransfer und einer Steigerung des OP-Qualitätsmanagements die Möglichkeit, innerhalb der ZSVA die Effizienz des Mitarbeiterinsatzes zu steigern und eine Reduzierung des Aufbereitungsaufwandes zu erreichen.

Waschen/Desinfektion

Reduzierung ...

- ... des Verbrauchs von Reinigungs- und Desinfektionsmitteln
- ... der Maschinenkapazitäten durch gezielte Aufbereitung
- ... der Wartungskosten durch reduzierten Einsatz

Packen

Reduzierung ...

- ... der Packzeiten
- ... des Packmaterials

Sterilisation

Reduzierung ...

- ... des Medienverbrauchs
- ... der Maschinenkapazitäten durch gezielte Aufbereitung
- ... der Wartungskosten

Logistik

Verbesserung ...

- ... der Verfügbarkeit von Instrumenten
- ... der Wagenkapazität

OP

Reduzierung ...

- ... der fallbezogenen Kosten
- ... der Komplexität des OP-Ablaufs
- Sicherung des OP-Qualitätsmanagements

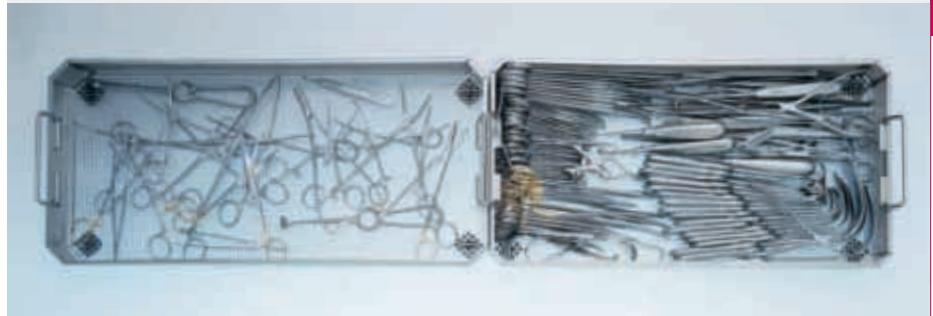

Nur die im linken Sieb befindlichen Instrumente wurden während einer OP aus dem gesamten Grundsieb benutzt. Trotzdem muss das gesamte Grundsieb mit allen Instrumenten in der ZSVA gereinigt, desinfiziert, gepackt, gepflegt und sterilisiert werden. Auf diese Weise werden Tonnen von Instrumenten unnötig aufbereitet. Eine Sieboptimierung kann die damit verbundenen Kosten deutlich reduzieren.

Kalkulationsbeispiel zur Kostenreduzierung durch eine Sieboptimierung

Beispiel vorher „ohne Sieboptimierung“

MIC-Set + Basis-Set
ca. 120 Instrumente

2 Sterilguteinheiten

bei einem Mittelwert von
15 Eingriffen pro Woche

1560 Sterilguteinheiten im Jahr

Beispiel nachher „mit Aesculap Sieboptimierung“

MIC-Set + einige zusätzliche Standard-Instrumente
ca. 45 Instrumente

1 Sterilguteinheit

bei einem Mittelwert von
15 Eingriffen pro Woche

780 Sterilguteinheiten im Jahr

Ergebnis „mit Aesculap Sieboptimierung“ u.a.:

- ca. 50% weniger Sterilisationskapazität
- ca. 50% Packzeitreduzierung
- ca. 20 – 40% weniger Materialeinsatz
- Steigerung der Mitarbeitermotivation

Think Partnership. Think Aesculap.

Hochwertige Werkzeuge verdienen Wertschätzung im wahrsten Sinne des Wortes. Der Instrumentenbestand einer Klinik stellt schließlich einen nicht unerheblichen Teil des Anlagevermögens dar.

Die Aesculap Qualitätsreparatur basiert daher auf den strengen Qualitätsnormen der Instrumentenherstellung und garantiert, dass Wert und Funktion jedes Instruments so lange wie möglich erhalten bleiben – mit Sicherheit. Zu Ihrem Vorteil.

Neben den geleisteten Einzelreparaturaufträgen sind Werterhaltungsverträge – insbesondere bei der Neuausstattung des OP – empfehlenswert. Die Budgetsicherheit sowie das detaillierte Reporting, welches die Prozesstransparenz erhöht und eine direkte Kostenstellenzuordnung ermöglicht, sprechen für die Aesculap Qualitätsreparatur.

Ein flächendeckendes Außendienstnetz von Aesculap Mitarbeitern und Fachhändlern stellt den zuverlässigen Service vor Ort jederzeit sicher.



Die Spezialisten vom Aesculap Technischen Service (ATS) sind darauf bedacht, den Lebenszyklus aller Instrumente zu verlängern und achten so z. B. auf einen möglichst geringen Materialabtrag beim Schleifen von Scheren. Ob schärfen, polieren, justieren oder reinigen – beim ATS geschieht alles mit einer konstanten Präzision und Sorgfalt.



Während die Aesculap Qualitätsreparatur bereits bei einfachen Standard-Instrumenten eine sinnvolle Investition darstellt, so ist sie bei hochwertigen, diffizilen Instrumenten wie z.B. einer Mikrofeder-
schere ein unbedingtes Muss. Jede unsachgemäße Reparatur kann aus einem wertvollen Instrument schnell ein ungeliebtes Abschreibungsobjekt machen – dem automatisch eine ungeplante Ersatzinvestition folgt.



Mit jeder durchgeführten Reparatur wird die Oberfläche der Instrumente übrigens komplett überarbeitet und mit dem ATS-Siegel sowie dem Reparaturdatum versehen. Denn auf jede Qualitätsreparatur gibt es ein Jahr Garantie.

Der Aesculap Technische Service ist für Sie da: Über unsere Hotline helfen erfahrene Spezialisten dem OP-Team schnell und zuverlässig aus der Klemme. Und reparaturbedürftige Instrumente werden durch unseren Service auf Wunsch in der Klinik abgeholt und nach erfolgter Qualitätsreparatur schnellstens retourniert.



Think Service. Think Aesculap.

Heute wird von Krankenhäusern mehr denn je wirtschaftliches Denken, effizientes Kostenmanagement sowie Rechts- und Patientensicherheit verlangt. Künftig müssen auch für das chirurgische Instrumentarium alle Abläufe klar dokumentierbar und eindeutig nachvollziehbar sein.

Damit dies zuverlässig funktioniert, bietet Aesculap seinen Kunden das Instrumenten Management System instacount®. Durch die Inventarisierung des Instrumentenbestands wird es möglich, Siebe und Instrumente über ihre gesamte Lebensdauer hinweg zuverlässig und übersichtlich in ihrem Kreislauf zu verfolgen.

Darüber hinaus können neben dem Einkaufspreis gleichermaßen die Kosten für Reparaturen und Handling pro Sieb, pro OP und pro Patient dokumentiert und entsprechend zugeordnet werden.

Neben der Systemlösung instacount® PLUS ist zudem auch eine BASIC-Version verfügbar, die sich als Plug and Play-Software einfach bedienen lässt. instacount® BASIC ist der ideale Einstieg in das Thema „EDV gestützte Dokumentation des Instrumenten Kreislaufes“, und ist ohne Probleme auf die Systemlösung instacount® PLUS zu erweitern.



instacount®

Mit der Entscheidung für instacount® PLUS oder instacount® BASIC geben Sie Ihrem Krankenhaus ein solides Fundament für die erfolgreiche Arbeit. Das systematische und effiziente Instrumenten Management macht die Instrumentenbestände transparent und erleichtert Planung und wirtschaftliche Koordination.

Sowohl in instacount® PLUS, wie auch in instacount® BASIC können Sie einfach und schnell Ihr gesamtes Instrumentarium nach den neuesten RKI Richtlinien klassifizieren und kommen so spielend Ihrer Dokumentationspflicht nach.



Instrumenten Management System

- Erstmalige Dokumentation und Standardisierung eines oftmals unklaren Prozesses mit vielen Schnittstellen und internen Reibungsverlusten
- Unterstützung des Aufbereitungsprozesses durch Packassistenten wie Arbeitsanweisungen und Mediaunterstützung (Bild, Ton, Video) u.v.m.
- Inventur auf Knopfdruck (Instrumente, Implantate, Verbrauchsmaterialien)
- Unterstützung der Siebstandardisierung durch frei definierbare Stammdaten mit Schablonen-Technik
- Transparenz über die erbrachten Leistungen durch aussagekräftige Produktionsstatistiken auf Artikel- und Setebene
- Verwaltung und Überwachung von Wartungsintervallen für Siebe, Sets und Artikel
- Automatische Kontrolle der Sterilitätsdauer gelagerter Siebe und Sets
- Einfaches Reparatur- und Bestellmanagement
- Automatische Kostenermittlung bei der Aufbereitung
- Ermittlung der Instrumentenauslastung
- Einzelne Sterilgut- oder Fallwagenzuordnung zum Patienten
- Zahlreiche Auswertungsfunktionen aus Patienten- und Sterilgut Sicht

PrimeLine Container

- neu konzipiertes permanentes Keimrückhaltesystem integriert in einen hochgradig thermostabilen Kunststoffdeckel
- Wirtschaftlichkeit durch einmalige Beschaffungskosten, niedrige Verbrauchskosten und „lifetime“ Funktion (5000 Zyklen validiert nach DIN EN 868, Teil 8, Anhang G)
- dem Erhalt der Sterilität während Lagerung, Transport und Sterilbereitstellung wird in vollem Umfang Rechnung getragen
- systematische Organisation des Sterilgutkreislaufes im Krankenhaus



Mit PrimeLine unterstreicht B. Braun Aesculap seine weltweit führende Position als Hersteller chirurgischer Instrumente und Sterilcontainer Systeme für die sichere und wirtschaftliche Sterilgutversorgung im Krankenhaus.

Think Competence. Think Aesculap.

Als kompetenter Partner in der medizinischen Fort- und Weiterbildung verknüpft die Aesculap Akademie durch intelligente Netzwerke Medical Professionals in der ganzen Welt. Unter dem Dach von B. Braun bietet sie ein durch Landesärztekammern oder medizinische Institutionen qualitätsgeprüftes Programm für Mediziner, Mitarbeiter in den Funktionsbereichen, Stationen und Praxen sowie Krankenhaus Management an.

Das Aesculaprium in Tuttlingen ist Stammsitz der weltweiten Aesculap Akademie Aktivitäten. Differenzierte Schulungskonzepte werden entwickelt, die Theorie und Praxis verbinden, aufeinander aufbauen – gemäß den Richtlinien der „Continuing Medical Education“. Das vielseitige Programm umfasst indikationsbezogene Seminare, Workshops und Schulungen ebenso wie Management-Seminare.

Die Mediathek ergänzt das Fortbildungsangebot durch mehr als 270 qualitätsgeprüfte Filme der Deutschen Gesellschaft für Chirurgie. Sie dokumentieren und kommentieren OP-Techniken und chirurgische Themen nahezu jeder Disziplin.

Exzellenz in der medizinischen Fortbildung.
Aesculap Akademie.



Innerhalb des Schulungskonzeptes ermöglicht der praxisorientierte Teil u.a. die Erprobung neuer Techniken sowie den Erfahrungsaustausch der Teilnehmer.





Fachkundelehrgänge zum Sterilgutassistenten – ein Beispiel aus der Praxis

Paul-Jürgen Metten arbeitet seit 1982 in der Rheinischen Klinik für Orthopädie in Viersen und leitet dort seit 1989 die OP- und ZSVA-Abteilung. Er absolvierte erfolgreich die Fachkundelehrgänge Sterilgutversorgung I – III von November 2002 bis Dezember 2003 an der Aesculap Akademie in Tuttingen. In den Fachkundelehrgängen werden von erfahrenen Fachreferenten umfassende

Kenntnisse für Mitarbeiter der ZSVA und der OP-Abteilung vermittelt. Die Lehrgangsinhalte reichen von der Instrumentenaufbereitung und -dokumentation über alle Bereiche der Qualitätssicherung, der Kostenrechnung und der Personalentwicklung bis hin zur Vermittlung von rechtlichen Grundlagen, Betriebswirtschaftslehre und speziellen EDV-Voraussetzungen. Die drei Lehrgangsteile bauen aufeinander auf, führen aber zu selbstständigen Abschlüssen. Alle Fachkundelehrgänge basieren auf den Richtlinien der Deutschen Gesellschaft für Sterilgutversorgung (DGSV).

Auszug aus dem Angebot der Aesculap Akademie

OP, ZSVA und Medizintechnik:

- Osteosynthesetechniken
- Endoprothetik
- Motorensysteme
- Qualitätsmanagement
- OP-Management
- Sterilcontainer/ZSVA
- ...

Mediziner:

- Laparoskopische Abdominal-/Viszeralchirurgie
- Laparoskopische Hernienchirurgie
- Mikro-Chirurgie
- Naht-Technik-Seminar
- Laparoskopische Urologie
- Laparoskopische Gynäkologie
- ...

Einkauf und Verwaltung:

- DRGs
- Kompaktwissen Einkauf und Management
- Prozessoptimierung
- Qualitätssicherung
- Vertragsrecht
- Marketing und Vergabeordnung
- ...

„Ich habe mich für die Ausbildung mit der Aesculap Akademie entschieden, um mich sowohl fachlich als auch persönlich weiter zu qualifizieren. Natürlich hatte ich gemischte Gefühle nach 22 Jahren im Beruf noch einmal die Schulbank 'zu drücken'. Als jedoch die Betriebsleitung der Klinik die Kostenübernahme für den Lehrgang zusagte und ich mich eingehend über die Organisation und die Inhalte der Schulung informiert hatte, war ich von der Richtigkeit meiner Entscheidung überzeugt. Unterbringung und Verpflegung waren ebenso hervorragend organisiert wie die Bereitstellung der umfassenden Arbeits- und Hilfsmittel. Bei Fragen standen die Mitarbeiter der Aesculap Akademie stets zur Verfügung. Alle Fragen wurden sofort und sachkundig beantwortet und eine konstruktive Diskussion war nicht nur während der Workshops jederzeit möglich und erwünscht. Durch die ständige pädagogische und fachliche Betreuung haben alle Teilnehmer die Prüfung bestanden – was nicht zuletzt natürlich auch den ausgewählten Referenten, die über eine hohe fachliche Kompetenz verfügten und die komplexen Lerninhalte verständlich und praxisnah vermittelten, zu verdanken war.

„Man entwickelt einen Blick für das Wesentliche und lernt, in umfassenden Zusammenhängen zu denken ...“

Im Nachhinein hat sich eindrucksvoll bestätigt, dass sich das neu erworbene Wissen mit hohem Nutzen und sprichwörtlich Gewinn bringend im praktischen Berufsleben umsetzen lässt. Der Blick für das Wesentliche wird geschärft und durch den umfassenden Unterrichtsstoff der aufeinander aufbauenden Lehrgänge ist es möglich, die Zusammenhänge im Krankenhaus besser zu erkennen und zu verstehen sowie Prozesse sinnvoll zu reorganisieren.

Für mich persönlich waren vor allem die Grundlagen des Qualitätsmanagements und der Zertifizierung von besonderer Bedeutung, wie auch die neuen Erkenntnisse zur Validierung von Großsterilisatoren und zur Werterhaltung von Instrumenten. Die Klinikleitung ist vom Ergebnis der Fachkundelehrgänge ebenfalls so überzeugt, dass in Zukunft alle Kolleginnen und Kollegen aus dem OP- und ZSVA-Bereich ihre Ausbildung an der Aesculap Akademie absolvieren werden.“

Think Aesculap.

Profound knowledge derives from appreciating the significance of individual pieces of knowledge or experience and fitting them together into a coherent network. A principle B. Braun has been following consistently for more than 160 years, clearly reflected in its corporate claim: "Sharing Expertise". Sharing knowledge across all company divisions creates a broader, sounder knowledge base for everyone involved, resulting in far sighted, detailed solutions and maximum safety. For the benefit of the patient and in the interests of the user.

With over 130 years of experience in the surgical instrument sector, the Aesculap Division is a competent partner for this interdisciplinary knowledge sharing process.

The Aesculap brand represents a varied spectrum that intelligently and economically combines high quality products with process-orientated services. Aesculap is a reliable and accepted partner for the entire surgical process in the hospital.

Aesculap owes its standing among the best in the business to its employees, who, searching for the best possible solution, are never satisfied with their initial idea. Who repeatedly examine, question and optimize every development.

Thus, Aesculap is much more than a supplier of high precision surgical instruments: a partner who listens carefully and contributes ideas, who understands the customers' needs and requirements and provides for them on a high level. From products to services and seminars for all areas of activity within the hospital.



Think Quality

Think Partnership



- I treat contracts like a partnership: based on mutual trust and respect.

Think Partnership. Think Aesculap.

Think Competence



- The Aesculap Information Center in Tuttlingen is unique. Nowhere else in the world could I advise my customers so competently and offer such choice.

Think Competence. Think Aesculap.



- Our instruments are held in high esteem by surgeons all over the world. I know why this is and I make sure it stays that way.

Think Quality. Think Aesculap.

- People I talk to can be critical at first: high quality, but still an economically sensible solution? Then I simply let the facts speak for themselves.

Think Economy. Think Aesculap.



Think Economy

Think Service



- Sometimes it's the minor details we provide that make the process run smoothly. The main thing is, everything works and everyone is happy.

Think Service. Think Aesculap.

Think Innovation



- Each new product is like your own baby. You lovingly take care of it until it grows up and leaves home.

Think Innovation. Think Aesculap.

Think Quality. Think Aesculap.

To satisfy our own high demands as well as our users' expectations, Aesculap's quality requirements are extraordinarily high. For over 17,000 products covering practically all indications in the separate disciplines: no easy undertaking.

From the very beginning, we have set our own quality standard, severely narrowing the standard tolerances permitted by the DIN and ISO norms.

This can already be seen in the selection and inspection of the raw materials we use, and it continues throughout the entire production process.

Our manufacturing technique, a combination of high technology and precision manual work, integrated with our knowledge and expertise, enable us to produce instruments that are always true to pattern, extremely precise and of consistent high quality.

After all, at Aesculap we have known for more than 130 years that there is nothing more economical than high quality.



■ Quality Assurance

An essential element in our comprehensive quality management system is process integration, from the product idea through development and production to the inspected finished instrument. This includes modern manufacturing techniques and validated procedures, including systematic quality checks, to ensure that Aesculap quality remains constantly high.





■ We can only guarantee reproducible Aesculap quality over decades thanks to the technical skill, experience and care of Aesculap's surgical instrument makers. Expertise that is responsibly and conscientiously shared with others.



Tungsten Carbide Instruments

For our instruments with tungsten carbide inserts we use only high quality nickel-bound tungsten carbide tips, well known for their high corrosion resistance and low wear.



Hemostatic Forceps – Olive in the Jaw

The olive forms the transition from the working end or jaw to the "joint" of the instrument. This special design makes the jaw more elastic and the instrument less liable to break.



How do we ensure that every Aesculap instrument conforms exactly to the shape and dimensions of the master pattern? We inspect every single one!

Think Innovation. Think Aesculap.

In constant dialogue with practitioners and clinical partners, Aesculap designs and creates instruments for all surgical disciplines – frequently setting the trend. A team of 200 people around the world is employed in research and development into new, economically viable solutions to provide the best patient care.

The essential focus is not on what is possible technologically, but on what makes sense medically. Sensible developments for us mean instruments that function in such a way that they decisively and positively influence the course of a surgical operation, whilst not losing sight of economic considerations. For example:



BipoJet Bipolar Dissecting Scissors for Open Surgery

BipoJet makes it possible to dissect, cut and coagulate in one step. For the surgeon, using BipoJet means that he or she can work more quickly, safely and efficiently. Innovative manufacturing technologies, such as the solid ceramic insert in the scissor blade and the PEEK synthetic coating ensure long life and safe electrical operation. For the hospital, efficiency, safety and long life represent an important economic advantage.



Münster Retraction System

The Münster Retraction System, now a byword for versatility, flexibility and stability in abdominal surgery, has been further developed to include a new open frame that can be quickly and easily adjusted into any position in three planes thanks to an innovative joint technology. This gives the user more freedom of action and further enhances the system's capacity to adapt to the individual operating situation.



Micro Instruments For Cardiovascular Surgery

Manufactured through latest production technologies, from selected materials, for outstanding functionality. The jaw working surfaces of needle holders and forceps are finished with Aesculap DIADUST diamond dust coating. The result: a hard and hard-wearing working surface. DIADUST coating ensures a reliable grip on fine needles and soft tissue.

Joint Development of BipoJet,



Aesculap cooperates closely with users in the development of new surgical instruments and the further development of existing products. This enables us to create high quality products that set new standards and satisfy the surgeons' wishes and requirements down to the last detail. Valuable synergies and outstanding projects flow from this collaboration between Aesculap specialists and experienced users, resulting time and again in trendsetting innovations in surgical instruments.

Aesculap development projects are conducted within a tightly designed project management system to ensure transparency and efficiency.



a Practical Example



Prof. Dr. med. Gottfried Müller is the Medical Superintendent of the Surgery Clinic in the Bad Mergentheim Charity Hospital, and has played a decisive role in the development of Aesculap surgical instruments for over 20 years.

More than 20 years of successful and enjoyable cooperation with Aesculap on a large number of project ideas means for me friendly and confident listening, discussions based on a thorough knowledge of the subject, accurate project research and programming in categories such as "innovation, feasibility, market expectation, function, ergonomics, material, quality, production, research, testing, functionality, safety, reliability, clinical controls, practicability, cost effectiveness, system suitability and market acceptability". All these headings lie behind projects that were and are interesting for me.

But Aesculap also means for me personal association with interesting people who bring their experience and strength

into many different contacts: engineers, technicians, secretaries, business managers, doctors and developers, many creative men and women from all professions.

For me, knowing Aesculap means having an insight into a large and serious entity whose task is to provide products for medicine – things that are directly to do with us as surgeons. Against this background, Aesculap is a name that every surgeon knows. Behind the name I see people at desks and workbenches putting all their commitment into cooperative projects; projects that will help to define my future in medicine.

The latest example of this is the joint development of BipoJet.

Dr. med. Albert Linder is Chief Consultant in the Thoracic Surgery Department in the Hemer Lung Clinic, and is convinced of the value of input from daily practice into the development of products to benefit daily practice. For more than 10 years, Dr. Linder has been working closely with Aesculap as a clinical adviser.

"The development of the BipoJet scissor is an outstanding example of how users' ideas originating from their daily practice in the operating theatre can become a high tech product ready for the market in a very short time. With Aesculap, this is done in excellent cooperation between the surgeon and the development team, and always on site, either in the operating theatre or in the workshop."



Think Competence. Think Aesculap.



Project consultation in the Aesculap Information Center in Tuttlingen involving representatives from all hospital departments.

The question of investing into surgical techniques has been made much more difficult and controversial by the constant changes in the healthcare market and by the introduction of DRGs and total quality management – once made, wrong decisions are extremely hard to put right.

The Aesculap project planning team of specialists with know-how and operational expertise supports hospitals and clinics in planning large or small projects and implements them expertly, reliably, and on time. All over the world.

The team cooperates with architects, technicians, doctors, nurses and hospital managers in analysing procedures, establishing needs and creating the necessary conditions for process optimization. The result is sound and effective project management from A to Z. Whether the task is to equip a new hospital or to build up a new discipline.

■ Information Visits

When planning an investment, you are faced with many questions and decisions that can often only be properly assessed afterwards. This is why we have made it our guiding principle to give you the greatest possible certainty in your decision-making. We offer our discussion partners the opportunity to form an exact picture of what we can provide, not only through our comprehensive consultation service in Tuttlingen, but also in the form of information visits, where you can have the chance to talk with colleagues in other hospitals on topics relating to all areas of activity. Everything to provide you with a sound basis for a confident decision.



Planning and Consulting – a Practical Example

"For complex projects you need a partner with vision, who keeps the overall concept in view when dealing with the details ..."

■ Dr. Dr. Dirk Knüppel

"The collaboration with Aesculap was brought about by the discipline swap between the Red Cross Clinic and the Clinic Maingau, both in-patient hospitals in the Frankfurt area with approximately thirty surgeons each. The supervisory authority had decided that the orthopaedic surgeons from Maingau should move to the Red Cross Clinic and that the gynaecologists and urologists from the Red Cross Clinic should move to Maingau by July 1st, 2003. The objective was to streamline the disciplines at each site, complying with the sponsors' demand that the same disciplines should no longer be available at both hospitals. This move was to coincide with the opening of a new operating theatre and functional wing in the Red Cross Clinic, incorporating a CSSD.

A complex project, that required external support from experienced consultants. To implement it, we were looking for a partner with vision, who would keep the overall concept in view when dealing with the details. And so, at beginning of 2002, we began discussions on the project with a consultant from Aesculap. We first looked together at the services Aesculap could offer before deciding what steps to take next. A detailed delivery and service contract – which in a worst-case scenario covered every element in the service package from the delivery of new instruments, refurbishment and value preservation to the installation of instacount®PLUS – ensured transparency and security right from the beginning. In addition, the assessment of requirements and cost estimate supplied by Aesculap provided a valuable basis for the hospitals' budget planning.

The consultation was based on an Inventory Analysis in both hospitals, the results of which were presented to the heads of nursing, surgery and hygiene and to the business directors. Aesculap began by

sorting the instruments from both hospitals into three categories: obsolete (high degree of corrosion), in need of repair, and still usable. Repair and refurbishment of the older instruments was organized in stages to avoid disrupting the everyday work of the departments affected more than was absolutely necessary. The next step was for Aesculap and the surgery managers to agree on the additional instruments and equipment required. On the one hand, this additional requirement was a result of the discipline swap, since enough instruments had to be available to carry out parallel operations in the same discipline. On the other hand, it arose from the need for the new, qualitatively enhanced CSSD to operate safely and smoothly. The instruments required were subsequently selected at the Aesculap headquarters in Tuttlingen and a new instrument set and container structure was developed, taking the needs of both clinics into account and excluding instruments that were no longer needed, thus saving the hospitals the expense of storing and maintaining them.

"It is all about finding the right economic combination – as many instruments as necessary, as few as possible"

At this stage of the project, the positive effects of Aesculap's consulting service were already becoming obvious to everybody concerned: early planning in the preparation stage helped to avoid timing and organizational bottlenecks to a great extent. During the entire restructuring phase the Aesculap consulting service offered the best possible support for staff already under additional pressure. Furthermore, the set and container optimization service saved unnecessary

Dr. Dr. Dirk Knüppel, MBA, Assistant to the Board of the Frankfurter Rotkreuz-Krankenhäuser e. V. and project director, talking about the Aesculap planning and consulting service in the context of the major project "discipline swap and new operating theatre at the RKH in Frankfurt"

costs for storing and maintaining redundant instruments and the procedures became much more economical.

Through the discipline swap, both hospitals gained a sharper profile with clear priorities, leading to higher case turnover and improved specialization. The optimization and standardization of processes we have achieved in collaboration with Aesculap has brought considerable cost savings in the medium term, and reflects our overall objective to offer the best possible quality of treatment at calculable costs. In addition to this, the restructuring, combined with the planning and consulting service provided by Aesculap, has helped us to adapt to DRG requirements while at the same time enhancing the quality of provision.

Since all decisions were taken in close consultation between Aesculap and the respective hospital managers, there were no information gaps and no delays. The discipline swap and the opening of the new operating theatre wing took place on time on July 1st, 2003, and here it should be emphasized that our partner from Aesculap did not just attend as a consultant, but took an active part in the proceedings in the truest sense of the word.



Think Economy. Think Aesculap.



You cannot work efficiently if you do not maintain the overview of your instrument stocks. It is only by knowing what instrumentation you have and by organising it logically and consistently that you can make real savings.

But who is going to take care of that in the day to day work in the hospital?

In its Inventory Analysis program, Aesculap, as a specialist service provider, makes a quantitative record and a qualitative analysis of the entire instrument stock – covering all disciplines and including all product suppliers. The result is an objective, detailed and up to date documentation of the hospital's stocks, including maintenance, repair and purchasing requirements together with the associated costs.

This is followed by Set Optimization, where the contents of the hospital's instrument sets are reorganized on site to comply exactly with the specific requirements of different indications and operating techniques. The working procedures in the hospital are discussed, a new concept for instrument sets is jointly worked out and new operating techniques can be explained if required.

All in all this concept contributes to maximum transparency, slims down procedures, opens up savings potential, provides security for investment planning and forms an essential component in quality management, with the goal of process optimization always in view.



Inventory Analysis and Set Optimization – a Practical Example

Prof. Dr. med. Hans-Rudolf Tinneberg, Medical Superintendent and Director of the Center for Gynaecology and Obstetrics at the Justus Liebig University, Giessen (Germany), and

Otto Armstroff, Head of Technical Purchases, talking about the development and outcome of the Aesculap project "Inventory Analysis and Set Optimization at the gynaecological clinic of Giessen University".

adapted to the range of operations performed at the gynaecological clinic. In agreement with the operating theatre managers, large sets where individual instruments could not be easily identified were divided up and instruments that changes in operating techniques had made obsolete were set aside. This led to an overall increase in the quality of our instrumentation, which will be ensured in the medium and long term through the maintenance contract we have concluded with Aesculap. In this way, we can be certain of having high quality and precise instrumentation always available for demanding operations.

The theatre staff have greatly benefitted from the optimization, since the clearer set contents have significantly reduced the error rate in the CSSD and the streamlined processes leave more time for the essentials: the patient and the quality of treatment. The reduced physical strain for staff through strict controls on set and load weights should also not be underestimated. The training sessions conducted on site by Aesculap during the project provided an additional boost to staff motivation. The aim was to train the staff in the handling and care of the instruments, and also to help them understand the instrument names that refer to the original authors (Langenbeck hooks, Metzenbaum scissors etc.) and introduce these names into the daily routine. In addition to this, a training session was also provided for the surgeons, where Aesculap again gave a thorough explanation of how the new set structure was organized (set system with some interdepartmental basic and supplementary sets).

Prof. Tinneberg

"Optimising our processes has given our staff more time for the essentials – the patient and the quality of treatment ..."

Excellent surgical results depend not only on the skills of the surgeon, but also on the quality of the instruments used and on the composition of the instrument sets. Now we have a set structure that is optimally adapted to our requirements, that takes full account of the spectrum of operations we perform and that substantially contributes to greater economy, streamlined processes and, last but not least, better results.

The optimized processes within the university's gynaecological clinic are partly the result of an Inventory Analysis and Set Optimization service that we commissioned from Aesculap in the autumn of 2002, after I had taken over as director of the clinic. The change in directorship led to a shift of emphasis towards operative gynaecology. We were generally dissatisfied with our own instruments in our everyday work, and so, in agreement with the hospital management, we decided to embark on fundamental changes. Aesculap was already involved in the initial discussions and convinced all participants of the merits of the Inventory Analysis and subsequent Set Optimization concept. The Inventory

Analysis was carried out by two specially trained Aesculap technicians and covered the entire range of surgical instruments. A detailed list of all instruments was compiled, providing transparency in the quantity of instruments in the clinic and documenting their quality and condition with regard to wear and tear and the need for refurbishment or repair. On the basis of this report, the overall value of the instrument stock and the repair and replacement costs were analysed. As only a small percentage of the existing instruments could be repaired to make them suitable for further use, we agreed with Aesculap to put together a completely new collection of instrument sets.

The surgeons' visit to Aesculap in Tuttlingen was extremely constructive. There we could choose instruments that matched our requirements down to the last detail, and even order special instruments custom-made to our wishes. The instrument set structure was completely optimized and

"...we can be certain of having high quality precise instrumentation always available for demanding operations..."

Think Economy. Think Aesculap.

An extremely positive aspect of our collaboration with Aesculap should be emphasized: the consultation process was, and remains, at all times subject-related, objective and never profit-orientated.



If desired, the Aesculap consultants' detailed Inventory Analysis report can be presented to representatives from the various areas of responsibility within the hospital and the possibilities for further action explored in joint discussions.

Otto Armstroff

From my perspective as head of purchasing, quality aspects are just as important as economic considerations. But this has very little to do with short term cost savings. In relation to a comprehensive Inventory Analysis and Set Optimization, this means planning a long way ahead and above all reducing complexities to the minimum.

For instance, we included in the project the changeover from a decentralized to a Central Sterile Supplies Department in the hospital, which allowed us to achieve lasting capacity gains in instrument reprocessing and to reduce costs. CSSD throughput times were also improved, since the homogenization of the set contents and the economical organization of the sets shortened the necessary packing times. Strict outsourcing of reprocessing meant

that all these activities were concentrated within the CSSD, releasing other staff for their intended tasks.

"Our goal:

to create transparency in the sense of quality assurance and to realize savings potential"

One important advantage of the process, both economically and in terms of professional quality management, is the fact that all instruments that nowadays have to be regarded as of dubious value (chromium-plated, corroded) were removed from our stocks, while old instruments that could be repaired or refurbished were subsequently re-integrated into the new set structure, leading to further cost savings. We now have a standardized

selection of instruments, each of which can be identified and traced by its article number. This level of transparency gives us the accuracy we need for our cost and budget planning, especially under DRG conditions.

The good interdepartmental communication between the project participants and Aesculap and the professional attitude of the Aesculap team during their work in the hospital ensured trouble-free progress at all times. Because of this positive outcome, the Giessen University Hospital Board has decided to commission Aesculap to carry out its Set Optimization service in the other surgical disciplines as well.

The advantages of Set Optimization, in addition to knowledge transfer and enhanced quality management in the operating theatre, are the possibility to enhance staff efficiency and to reduce reprocessing costs in the CSSD.

Washing/Disinfecting

Reduction in ...

- ...the use of cleaning agents and disinfectants
- ...machine capacity requirements through restricting reprocessing to instruments actually needed
- ...maintenance costs through lower usage

Packing

Reduction in ...

- ...packing times
- ...packing material

Sterilization

Reduction in ...

- ...use of consumables
- ⌘ ...machine capacity requirements through restricting reprocessing to instruments actually needed
- ⌘ ...maintenance costs

Logistics

Improvement in ...

- ⌘ ...instrument availability
- ⌘ ...trolley capacities

Operating Theatre

Reduction in ...

- ⌘ ...case-related costs
- ⌘ ...complexity of theatre procedure



From the entire contents of the general instrumentation set, only the instruments in the tray on the left were actually used during an operation. In spite of this, the entire set of instruments had to be washed, disinfected, given general maintenance and sterilized in the CSSD. Tons of instruments are unnecessarily reprocessed in this way.

Set Optimization can substantially reduce the associated costs.

Sample Calculation of Cost Reduction Following Set Optimization

Before Set Optimization:

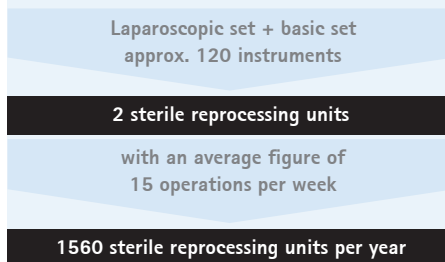

After Set Optimization by Aesculap:

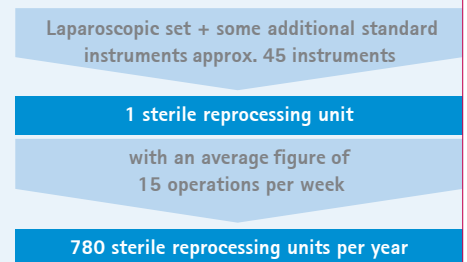

Just some of the results of Aesculap Set Optimization:

- ⌘ approx. 50% less sterilization capacity required
- ⌘ approx. 50% reduction in packing times
- ⌘ approx. 20 – 40 % less use of materials
- ⌘ improved staff motivation

Think Partnership. Think Aesculap.

High quality instruments deserve to be valued in the truest sense of the word. After all, the instrument stock represents no small proportion of a hospital's total assets.

For this reason, the Aesculap quality repair is based on the same strict quality standards we apply to instrument production. This guarantees that the value and function of each instrument is maintained for as long as possible – safely and surely. To your advantage.

In addition to carrying out individual repair orders, we think that contracts to maintain the value of the instrument stock are to be recommended – especially when equipping a new operating theatre. Secure budgeting and detailed financial reporting, increasing process transparency within the hospital and allowing costs to be directly allocated to cost centres, speak for the Aesculap quality repair.

A blanket network of Aesculap sales representatives and distribution partners ensures reliable service on site at all times.



■ The aim of the Aesculap Technical Service (ATS) specialists is to lengthen the useful life of all instruments. They are careful, for instance, to remove as little material as possible when re-grinding scissors. Whether sharpening, polishing, adjusting or cleaning – in the ATS everything is always done with the same precision and care.



■ The Aesculap quality repair already represents a sensible investment for simple standard instruments. For high value, difficult instruments such as micro spring scissors it is an absolute must. Every incorrect or inadequate repair can quickly turn a valuable instrument into a useless write-off – automatically resulting in an unplanned investment in order to replace it.



After every repair, the surface of the instrument is completely refurbished and labelled with the ATS seal and the repair date.

The Aesculap Technical Service is there for you: experienced specialists help surgical teams out of their difficulties swiftly and reliably via our hotline. If desired, our collection and delivery service will pick up instruments for repair from the hospital and return them as quickly as possible after the quality repair has been carried out.



Think Service. Think Aesculap.

Today more than ever before, hospitals are being required to think economically and manage their costs efficiently, as well as to ensure their own legal security and the safety of their patients. In future, all processes involving surgical instrumentation will also need to be clearly documented and fully accountable.

To make sure this functions reliably, Aesculap offers its customers the instacount® Instrument Management System. Making an inventory of the instrument stock allows the circulating sets and instruments to be traced clearly and reliably throughout their lifetime.

Moreover, as well as the instrument purchase price, the repair and handling costs per set, per operation and per patient can also be documented and allocated accordingly.

In addition to the instacount®PLUS system solution, a BASIC version is now available as an easy to use plug and play software option. instacount®BASIC offers the ideal entry into computer assisted documentation of the instrument cycle, and can be expanded into the instacount® PLUS system solution without any difficulty.



instacount®

Deciding on instacount®PLUS or instacount®BASIC gives your hospital a solid foundation for successful working. Systematic and efficient Instrument Management creates transparency in your instrument stocks and makes planning and economic coordination easier.



Instrument Management System

- ⌘ makes it possible for the first time to document and standardize a process
- ⌘ improves clarity, system management and optimization
- ⌘ supports sterile reprocessing with package assistants such as working instructions and media support (picture, sound, video) etc.
- ⌘ inventory at the touch of a button (instruments, implants, consumables)
- ⌘ assists the standardization of sets through freely definable master data with template technology
- ⌘ provides transparency in tasks performed through informative production statistics on the product and set level
- ⌘ controls and monitors the servicing intervals for trays, sets and individual products
- ⌘ control automatic the sterility dates for trays and sets in storage
- ⌘ manages simpler repairs and ordering
- ⌘ calculates automatically costs for reprocessing
- ⌘ establishes instrument utilization
- ⌘ allocates individual the sterile goods or case trolleys to patients
- ⌘ runs numerous analysis functions by patient or sterile goods

PrimeLine Containers

- ⌘ newly designed permanent sterile protection system integrated into a high quality thermostable plastic lid
- ⌘ economical: one-off purchasing costs, low consumable costs and "lifetime" function (5000 sterilization cycles validated in conformance with DIN EN 868, Part 8, Annex G)
- ⌘ Maintenance of sterility fully assured during storage, transport and sterile preparation for use
- ⌘ systematic organization of the sterile goods cycle in the hospital



With PrimeLine, B. Braun Aesculap underlines its position as world leader in the manufacture of surgical instruments and sterile container systems for the safe and economical supply of sterile goods in the hospital.

Think Competence. Think Aesculap.

As a competent partner in medical training and education, the Aesculap Academy uses intelligent networks to link up medical professionals all over the world. The quality of the program that the Academy offers for medical professionals, workers in specialist departments, wards and surgeries as well as for hospital management staff, all under the roof of B. Braun, is inspected and approved by the German state chambers of physicians or other medical bodies.

The Aesculapium in Tuttlingen, Germany, forms the headquarters for the Aesculap Academy's international activities. Differentiated training concepts have been developed, combining theory and practice and building one upon the other – in accordance with the guidelines for "Continuing Medical Education". The varied program includes indication-related seminars, workshops and training courses as well as management seminars.

The Mediathek supplements the training program with more than 270 approved quality films from the German Surgery Association. These document and comment on operating techniques and surgery topics from practically every discipline.

Excellence in medical training.
Aesculap Academy.



The practice-orientated component in the training concept allows participants to try out new techniques and exchange experience.





Specialist training courses to become a Sterile Processing Technician – a practical example

Paul-Jürgen Metten has been working in the Rhine Clinic for Orthopaedics in Viersen since 1982, and has been in charge of the Surgery and CSSD Department there since 1989. Between November 2002 and December 2003 he successfully completed Specialist Training Courses I – III in Sterile Goods Supply at the Aesculap Academy in Tuttlingen. In these courses, CSSD

and surgery staff are given comprehensive knowledge by experienced tutors. The course contents range from instrument reprocessing and documentation, all aspects of quality assurance, cost accounting and personnel development to basic legal knowledge, business management and specific IT requirements. The three course modules build on each other, although each concludes with an independent qualification. All specialist training courses are based on the guidelines of the Deutsche Gesellschaft für Sterilgutversorgung (DGSV), the German Society for the Supply of Sterile Goods.

A Selection from the Aesculap Academy's Training Programme

Surgery, CSSD and Medical Technology:

- Osteosynthesis techniques
- Arthroplasty
- Motor systems
- Quality management
- Surgery management
- Sterile containers/CSSD
- ...

Doctors:

- Laparoscopic abdominal and visceral surgery
- Laparoscopic hernia surgery
- Microsurgery
- Suture techniques seminar
- Laparoscopic urology
- Laparoscopic gynaecology
- ...

Purchasing and Hospital Management:

- DRGs
- Compact Purchasing and Management course
- Process optimization
- Quality assurance
- Contract law
- Marketing and order placement
- ...

"I decided on training with the Aesculap Academy in order to extend my qualifications both professionally and personally. Of course, I had mixed feelings about "going back to school" after 22 years in a job. However, after the management of the Clinic had agreed to pay the cost of the course and I had informed myself in detail about the organization and the content of the training program, I was convinced that I had made the right decision. The organization of accommodation and catering was as excellent as the provision of comprehensive learning and support material. The Aesculap Academy staff were always on hand to answer any questions, which they did immediately and expertly. Constructive discussion was possible and indeed invited at all times, and not only during the workshops. Thanks to the constant support of the teaching and technical staff, all the participants passed the examination. Thanks are also due of course to the specially selected tutors, who possessed a high degree of competence in their subject and who managed to convey the complicated contents of the course in an understandable and practical way.

"You develop a view for the essential, and learn to think in terms of connections...."

Looking back, I am impressed by the way in which my newly acquired knowledge can be translated into my daily professional activities to great advantage to myself and to the hospital. You develop a sharper view for the essential, and the comprehensive teaching material in the courses enables you to recognize and understand the connections that exist within the hospital, as well as teaching you how to reorganize processes sensibly.

For me personally, learning the basics of quality management and certification was particularly important, as was the knowledge I acquired about the validation of large sterilizers and preserving the value of surgical instruments. The clinic management is also so convinced by the result of the training courses that in future all colleagues working in surgery and CSSD departments will attend training courses at the Aesculap Academy."

Inhaltsübersicht - Table of Contents

Seiten
Pages

AC/AD



Untersuchung-Diagnostik, Vorbereitung
Examination-Diagnostic, Preparation

1-20

BA



Sterilskalpelle, Skalpelle, Messer
Sterile Scalpels, Scalpels, Knives

21-36

BB



Skalpellklingen und Griffe
Scalpel Blades and Handles

37-46

BC



Scheren
Scissors

47-136

BD



Pinzetten
Dissecting- and Tissue Forceps

137-182

BF



Korn- und Tupferzangen, Waschzangen, Tuchklemmen
Sponge- and Dressing-Forceps, Washing Forceps, Towel Clamps

183-208



Inhaltsübersicht - Table of Contents

Seiten
Pages

209-242

Arterienklemmen, Bulldogklemmen,
Gefäßclipse, Approximatoren
Hemostatic Forceps, Bulldog Clamps,
Vessel Clips, Approximators



BH

243-274

Präparier- und Ligaturklemmen, Hysterektomieklammern
Dissecting- and Ligature Forceps, Hysterectomy Clamps



BJ

275-280

Nähnadeln, Nadeldosen
Surgical Needles, Needle Cases



BL

281-340

Nadelhalter, Naht-Instrumente,
Unterbindungsnadeln und Hohlsonden
Needle Holders, Suture Instruments,
Ligature Needles, Guiding Probes



BM

341-354

Sonden, Watteträger, Wundklammern
Probes, Cotton Applicators, Suture Clips



BN

355-454

Wundhaken
Wound Retractors



BT

Inhaltsübersicht - Table of Contents

Seiten
Pages

BV



Wundspreizer, Bauchdeckenhalter
Self-Retaining Retractors, Abdominal Retractors

455-504

GK



Elektrochirurgie
Electrosurgery

505-536

EA



Abdominale Chirurgie, Magen-, Darm- und Rektum-Instrumente
Abdominal Surgery, Intestinal- and Rectal Instruments

537-588

EB



Instrumente für Galle, Leber und Milz
Gall Bladder-, Liver- and Spleen Instruments

589-606

EF



Urologie-Instrumente
Genito-Urinary Instruments

607-632

EJ



Trokare
Trocars

633-634



Inhaltsübersicht - Table of Contents

Seiten
Pages

635-660

Scheidenspekula
Vaginal Specula



EL

661-668

Uterus-Dilatatoren
Uterine Dilators



EM

669-694

Uterussonden, Tampon-, Haken-, Uterusfasszangen
Uterine Probes, Uterine Dressing-,
Tenaculum and Uterine Elevating Forceps



EO

695-718

Biopsie- und Kürettage-Instrumente
Biopsy Instruments and Curettes



ER

719-736

Geburtshilfe
Obstetrics



ET

737-890

Herz-, Thorax- und Gefäß-Chirurgie
Cardiovascular- and Thoracic Surgery



FB

Inhaltsübersicht - Table of Contents

Seiten
Pages

FF



Knochenstanzen, Rongeurs
Bone Punches, Rongeurs

891-914

FH



Amputation
Amputation

915-926

FK



Knochenhebel, Elevatorien,
Raspatorien, Scharfe Löffel
Bone Levers, Periosteal Elevators,
Bone Curettes

927-990

FL



Hämmer, Meißel
Mallets, Chisels and Gouges

991-1012

FO



Knochenhalte-zangen, Hohlmeißelzangen,
Knochensplittierzangen
Bone Holding Forceps, Bone Rongeurs,
Bone Cutting Forceps

1013-1050

LX



Drahtextension, Handbohrapparate, Ahlen, Pfieme
Wire Extension, Hand Drills, Awls

1051-1080



Inhaltsübersicht - Table of Contents

Seiten
Pages

1081-1088

Gips-Instrumente
Plaster Instruments



LX

1089-1106

Sauginstrumente
Suction Instruments



GF

1107-1110

Nierenschalen, Laborschalen
Kidney Trays, Bowls



JG

1111-1116

Instrumentenpflege, Reinigungshinweise
Care and Maintenance of Instruments



JG

1117-1143
1144-1169
1170-1196

Alphabetischer Index
Alphabetical Index
Numerischer Index
Numerical Index

A - Z
0 - 9

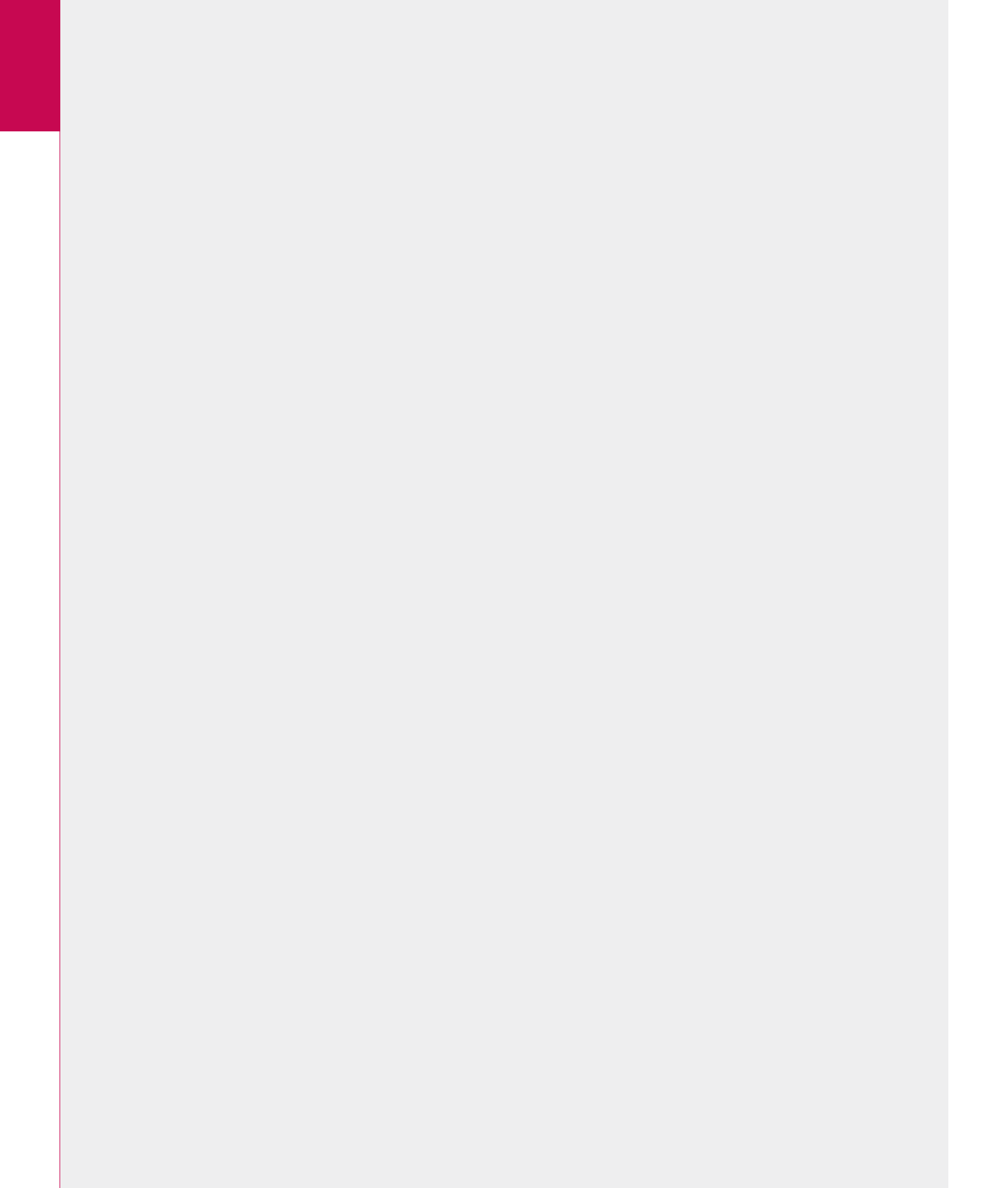

AC/AD



Untersuchung-Diagnostik, Vorbereitung
Examination-Diagnostic, Preparation

Untersuchung – Diagnostik – Examination – Diagnostic

Reflexspiegel und Stirnbänder Head Mirrors and Head Bands



ZIEGLER

AC402

Stirnspiegel allein, mit Gummifassung
Head mirror only, with rubber coating



ZIEGLER

OF090

Stirnspiegel allein, mit Metallfassung
Head mirror only, with metal coating



ZIEGLER

AC413

Stirnband aus Plastik, schwarz, allein
Head band of plastic, black, only

AC414

Stirnband aus Plastik, weiß, allein
Head band of plastic, white, only



MURPHY

AC415

Stirnband aus Celluloid, weiß, allein
Head band of celluloid, white, only



AC416

Stirnband aus Plastik, weiß,
allein, weiches Modell
Head band of plastic, white,
only, soft pattern



AC421

Stirnspiegel (AC402)
mit schwarzem Plastikband (AC413)
Head mirror (AC402)
with black plastic head band (AC413)

AC





Untersuchung – Diagnostik – Examination – Diagnostic

Stirnlampen Head Lights

AC



AC440

220 Volt
Transformator
220 volts
Transformater



CLAR 55

AC461

Stirnlampe, 6 Volt, mit verstellbarem Gelenk, weißem Stirnband aus Celluloid mit Schaumgummipolsterung und Kabel mit Zwischenstecker zum Trafo AC440

Head light, 6 volt, with adjustable joint, white celluloid head band, with foam rubber pad and cord with plugs for transformer AC440

AC462

Reflektor, allein, für Stirnlampe AC461
Mirror, only, for head light AC461

AC464

Ersatz-Schaumgummipolsterung für Stirnband AC454
Spare foam rubber pad, for head band AC454



AC463

Ersatzbirnchen
Spare bulb

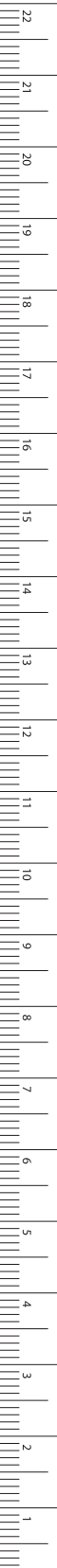

MILLIMETERS

Untersuchung – Diagnostik – Examination – Diagnostic

Zungenspatel

Tongue Depressors

AC

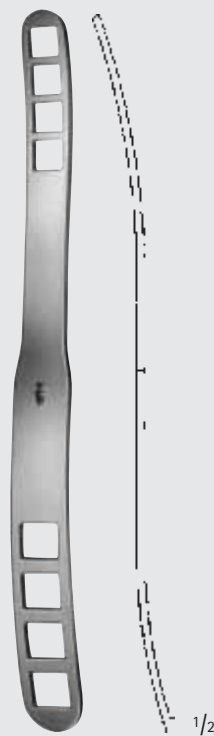



Untersuchung - Diagnostik - Examination - Diagnostic

Kehlkopfspiegel Laryngeal Mirrors

AC

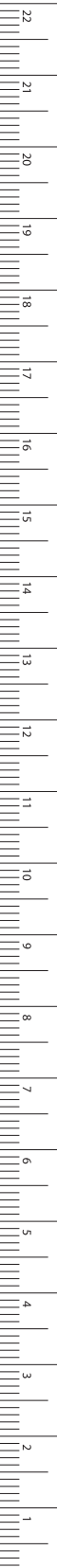

**OM078R/
AC468R**

Fig. 000
Ø 6 mm
diam. 6 mm



**OM079R/
AC469R**

Fig. 00
Ø 8 mm
diam. 8 mm



**OM080R/
AC470R**

Fig. 0
Ø 10 mm
diam. 10 mm

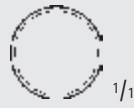

**OM081R/
AC471R**

Fig. 1
Ø 12 mm
diam. 12 mm



**OM082R/
AC472R**

Fig. 2
Ø 14 mm
diam. 14 mm



**OM083R/
AC473R**

Fig. 3
Ø 16 mm
diam. 16 mm



**OM084R/
AC474R**

Fig. 4
Ø 18 mm
diam. 18 mm



**OM085R/
AC475R**

Fig. 5
Ø 20 mm
diam. 20 mm

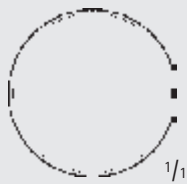

**OM086R/
AC476R**

Fig. 6
Ø 22 mm
diam. 22 mm

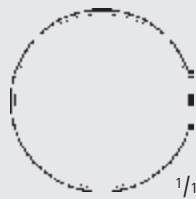

**OM087R/
AC477R**

Fig. 7
Ø 24 mm
diam. 24 mm

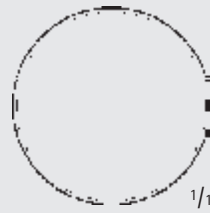

**OM088R/
AC478R**

Fig. 8
Ø 26 mm
diam. 26 mm



**OM089R/
AC479R**

Fig. 9
Ø 28 mm
diam. 28 mm

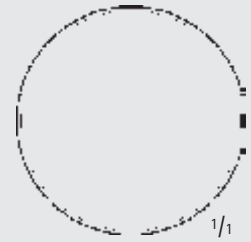

**OM090R/
AC480R**

Fig. 10
Ø 30 mm
diam. 30 mm



**OM078R-
OM090R**

Kehlkopfspiegel
mit Sechskantgriff
Laryngeal mirrors
with hexagonal handle
180 mm,
7"



**AC468R-
AC480R**

Kehlkopfspiegel
Laryngeal
mirrors
120 mm,
4 3/4"



AC481R

Spiegelgriff
Mirror
handle
110 mm,
4 3/8"



AC483C

Spiegelgriff
Mirror
handle
105 mm,
4 1/8"

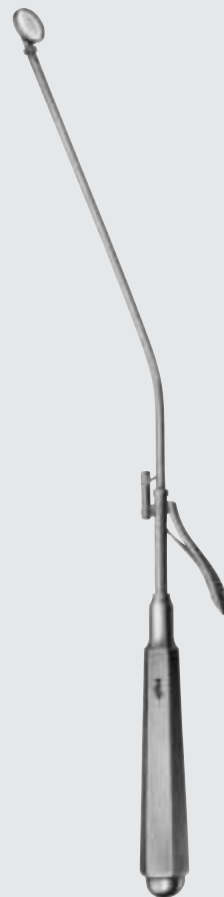

AC497R
Ø 12 mm
diam.
12 mm



AC498R
Ø 14 mm
diam.
14 mm

MICHEL

**AC497R/
AC498R**

Rhinoskopspiegel
Rhinoscopic mirrors
250 mm, 10"

MILLIMETERS

Untersuchung – Diagnostik – Examination – Diagnostic

Stimmgabeln

Tuning Forks

AC



HARTMANN

- OF001N = c 128
- OF002N = c¹ 256
- OF003N = c² 512
- OF004N = c³ 1024
- OF005N = c⁴ 2048
- OF006N = c⁵ 4096



OF010N = a¹ 440

Stimmgabeln für Neurologen
Tuning forks for neurologists

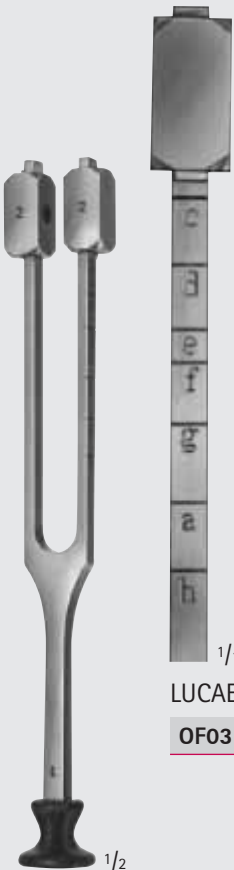

LUCAE

OF031N = c 128



RYDEL-SEIFFER

OF033N

mit Dämpfer = c 64
ohne Dämpfer = c 128
with clamps = c 64
without clamps = c 128



Untersuchung – Diagnostik – Examination – Diagnostic Instrumente zum Messen Instruments for Measuring



AA804R-AA806R

Stahlmaßstab, nichtrostend,
Millimeter- und Zolleinteilung
Steel ruler, stainless, graduated
in millimeters and inches

AA804R	AA805R	AA806R
150 mm	300 mm	500 mm
6"	12"	20"

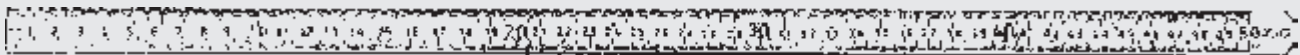

AA808R

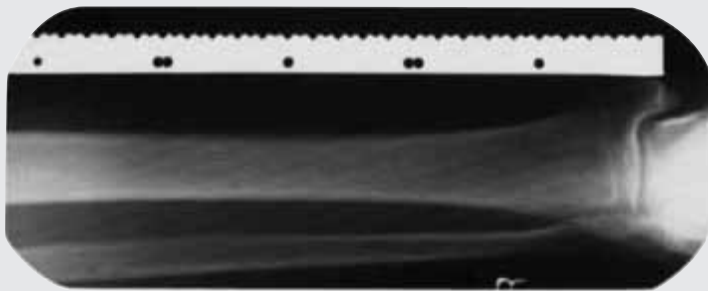

Röntgen-Messstab für Messungen bei Frakturbehandlung.
Direkte Ablesemöglichkeit der Abmessungen.
Einteilung in 1/2 cm durch gut sichtbare Kerben an
der Kante, die vollen cm sind durch tiefe Kerben
ersichtlich. Um das Ablesen zu erleichtern, sind
die 5 cm und 10 cm Abstände durch Löcher markiert.
Ruler for X-ray work in fracture treatment.
Direct reading. Graduation from half to half cm by
distinct notches at the rim. Full cms are accentuate
by deeper notches. Markings of 5 cm and decimeter
distance by one and two holes respectively.
500 mm, 20"

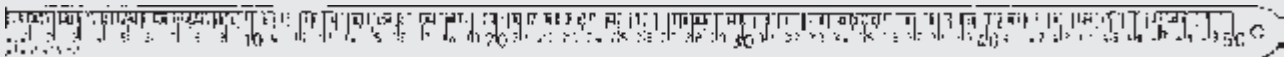

AA809

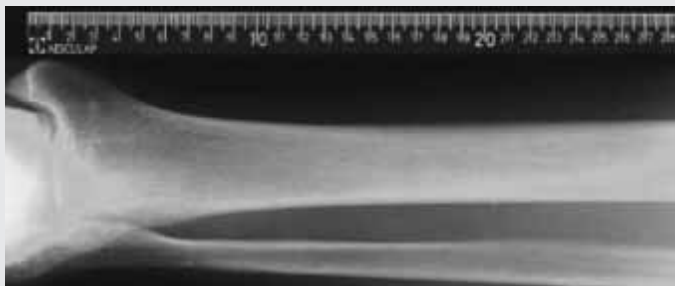

Röntgen-Messstab aus Kunststoff, flexibel
im Autoklav sterilisierbar bei 143°C (3 bar).
Dieser Röntgen-Messstab hat den Vorteil, dass die
Zahlen und die Millimeteerteilung im Röntgenbild
gut sichtbar sind.
Plastic ruler, flexible, for X-ray work.
Can be sterilized in an autoclave at 143°C (3 bar).
Figures and mm-graduation transparent to X-ray.
500 mm, 20"



AA821C-AA822C

Stahlmaßband, Millimeter- und Zolleinteilung
Steel tape measure, graduated in millimeters and inches

AA826

Maßband aus Wachstuch, Millimeter- und Zolleinteilung
Tape measure of oilcloth, graduated in millimeters and inches

Hinweis:
Nicht zur Dampfsterilisation geeignet
Note:
Not suitable for steam sterilization

AA821C	AA822C	AA826
1,5 m	2,0 m	1,5 m
60"	80"	60"

AD

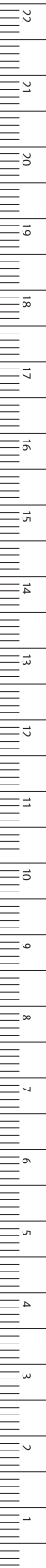

MILLIMETERS

Untersuchung – Diagnostik – Examination – Diagnostic

Instrumente zum Messen

Instruments for Measuring

AD



AA845R

Spezial-Messschieber
für die Neurochirurgie

Special caliper
for neurosurgery

125 mm, 5"



AA846R

Messschieber,
Messbereich bis 150 mm

Caliper,
measuring range up to 150 mm
230 mm, 9"



AA847R

Messschieber,
Messbereich bis 100 mm

Caliper,
measuring range up to 100 mm
130 mm, 5 1/8"



AD110R

Finger-Goniometer
Finger goniometer



AD123R

Ø 33 mm
diam. 33 mm



AD125R

Ø 38 mm
diam. 38 mm



AD127R

Ø 42 mm
diam. 42 mm

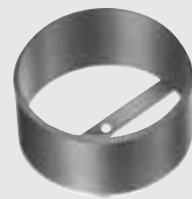

AD129R

Ø 48 mm
diam. 48 mm

AD123R-AD129R

Mamillenmarkierer, gezahnt
Mamilla marker, toothed



Untersuchung – Diagnostik – Examination – Diagnostic

Vorbereitung Preparation

AN



BA244R

Rasierklingenmesser für auswechselbare Klingen, mit Sicherheitskamm
Razor for interchangeable blades, with safety clip



BA245R

Ersatzklingen
Bestelleinheit: **PAK** = Packung a 10 Stück
Spare blades
Sales unit: **PAK** = Package of 10 pieces
70 mm, 2 3/4"



GH201-GH204

Die Wartung der AESCULAP Electra® II ist problemlos. Der dauergefettete Elektromotor mit ruhigem Lauf benötigt keine Pflege, nur die Schneideköpfe sind regelmäßig zu ölen. Die Maschine ist schutzisoliert.
Elektrische Schermaschinen (ohne Schneideköpfe)
Maintenance for the AESCULAP Electra® II is no problem at all. The permanently lubricated motor does not need any maintenance - only the cutterheads require periodic oiling. The clipper is double insulated.
Electric hair clippers (without cutterheads)

GH201

110-125 Volt
110-125 volts

GH204

220 Volt
220 volt

Zulassungen:
Registrations:

gemäß Richtlinie 89/336/EWG und 73/23/EW
conforming to directive 89/336/EEC and 73/23/EEC



GH700-GT784

Auswechselbare Schneideköpfe
Interchangeable cutterheads

Schnitthöhe
Height of clip

GH700	1/20 mm		
GH703	1/10 mm		
GT730	1/2 mm		
GH712	1 mm		
GT736	1 mm	weite Zahnung	wide tooth
GT746	1,5 mm		
GT710	1,8 mm	feine Zahnung	fine tooth
GH715	2 mm	kurze Zähne	short teeth
GT742	2 mm	lange Zähne	long teeth
GT754	3 mm	kurze Zähne	short teeth
GT748	3 mm	lange Zähne	long teeth
GT758	5 mm		
GT770	7 mm		
GT779	9 mm		
GT782	12 mm		
GT784	16 mm		

Hinweis:

Die Schneideköpfe passen auch auf den seither gelieferten Maschinentyp Elektra I.

Note:

Cutterhead system - to be used interchangeably for Elektra II as well as for Elektra I clipper.



MILLIMETERS

Untersuchung – Diagnostik – Examination – Diagnostic

Vorbereitung

Preparation

weitere Waschzangen siehe Rubrik BF
further dressing forceps see section BF

AN

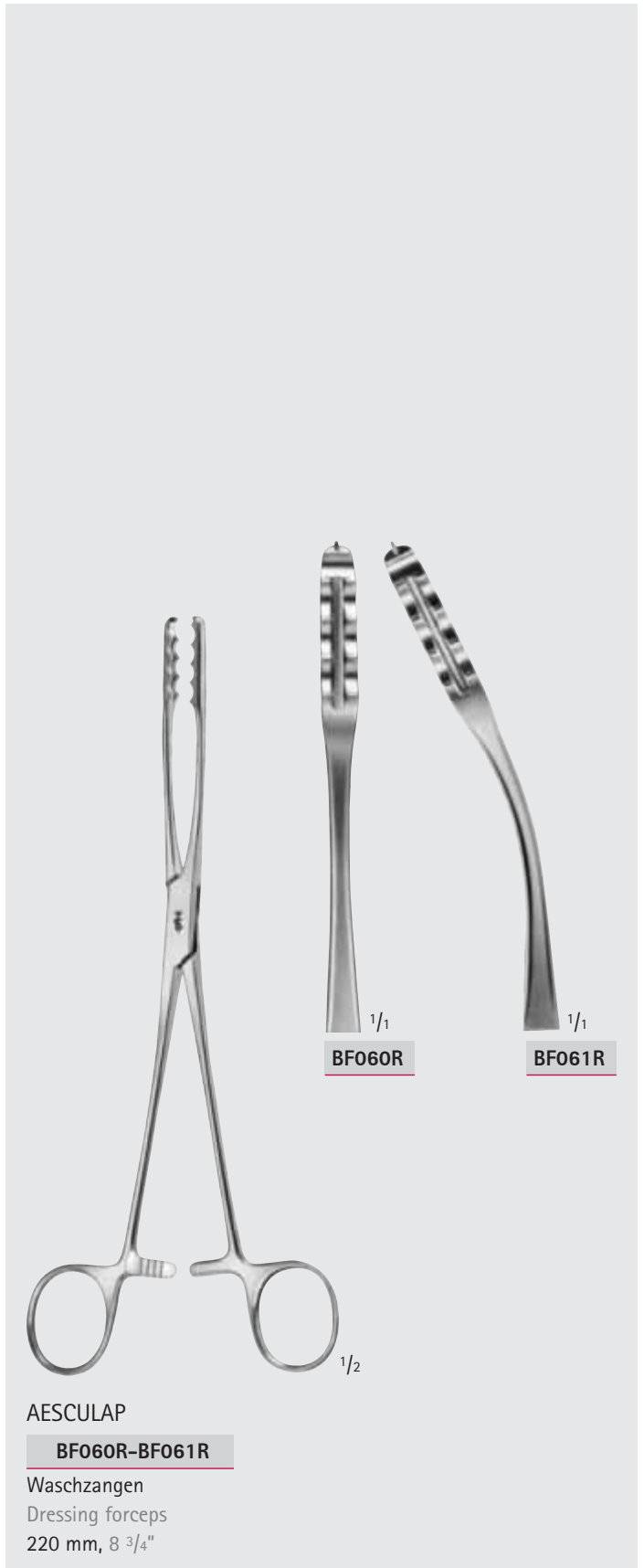



Untersuchung – Diagnostik – Examination – Diagnostic

Vorbereitung
Preparation

AN

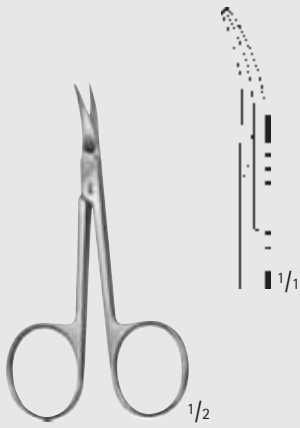

HF400R

Nagelschere
Nail scissors
90 mm, 3 1/2"

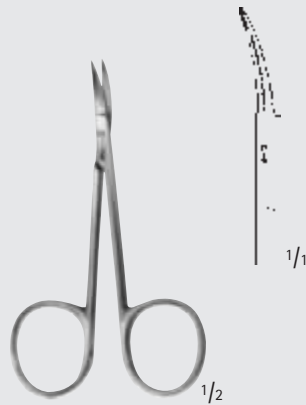

HF409R

Nagelschere
extra feines Modell
Nail scissors
especially delicate pattern
90 mm, 3 1/2"



HF032R

Baby-Nagelschere
Baby nail scissors
85 mm, 3 1/8"



HF014R-HF021R

Nagelscheren
Nail scissors

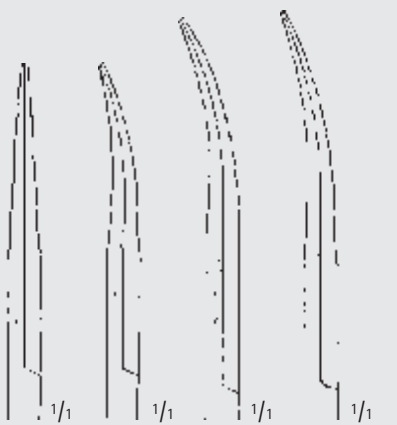

HF014R	HF019R	HF020R	HF021R
90 mm	90 mm	100 mm	110 mm
3 1/2"	3 1/2"	4"	4 3/8"



HF028R-HF031R

Nagelscheren
Nail scissors

HF028R	HF030R	HF031R
95 mm	95 mm	105 mm
3 3/4"	3 3/4"	4 1/8"



MILLIMETERS

Untersuchung – Diagnostik – Examination – Diagnostic

Vorbereitung

Preparation

AN



BC056R

BC057R

BC056R-BC057R
90 mm, 3 3/4"

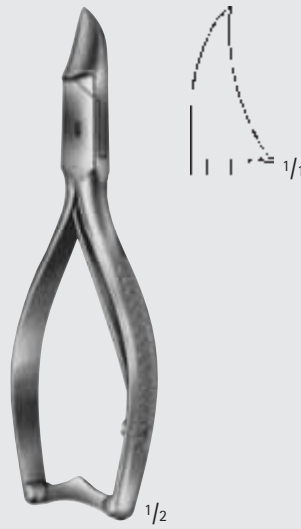

HF213R

Nagelzange
Nail cutter
135 mm, 5 1/4"

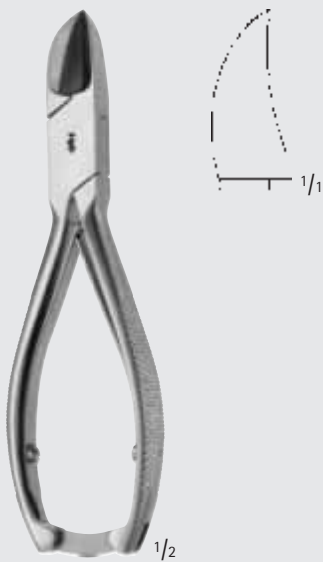

HF234R

Nagelzange
Nail cutter
145 mm, 5 3/4"



HF250R

Nagelzange
Nail cutter
155 mm, 6"





1/2

HF520R

Nagelschere HF020R und Nagelfeile HF514R
 mit 50 cm langer verchromter Kette HF519C
 Nail scissors HF020R and nail file HF514R
 with 50 cm (19 1/2"), chromium plated-chain HF519C



1/1

1/1

HF514R

Nagelfeile
 Nail file
 100 mm, 4"



1/1

HF566R

Nagelfeile
 Nail file
 150 mm, 6"



MILLIMETERS

Untersuchung – Diagnostik – Examination – Diagnostic

Narkoseinstrumente

Instruments for Anaesthesia

Zungenspatel siehe Rubrik AC
Tongue depressors see section AC



1/2

OM010

Mundsperrer aus Holz
Mouth gag wooden
140 mm, 5 1/2"



1/1

SCHMID

OM015R

Mundsperrer stufenlos durch Gewinde zu verstellen, 1 Maulteil beweglich gelagert
Mouth gag, infinitely adjustable by thread, with 1 moveable part



1/2

HEISTER

OM030R

Mundsperrer
Mouth gag
130 mm, 5 1/8"



1/2

FERGUSSON-ACKLAND

OM044R

Mundsperrer
Mouth gag
145 mm, 5 3/4"



Untersuchung - Diagnostik - Examination - Diagnostic
 Narkoseinstrumente
 Instruments for Anesthesia

AN

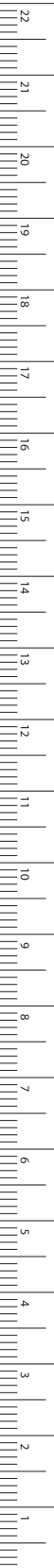

1/2

OM047R

Mundsperrer
 Mouth gag
 125 mm, 5"



1/2

ROSER-KÖNIG

OM048R

Mundsperrer
 Mouth gag
 160 mm, 6 1/4"



1/2

ROSER-KÖNIG

OM049R

Mundsperrer
 Mouth gag
 185 mm, 7 1/4"



1/2

MAGILL

AN379R-AN381R

Kathetereinführungszangen
 Catheter introducing forceps



AN379R

für Kleinkinder
 for infants
 150 mm
 6"



AN380R

für Kinder
 for children
 200 mm
 8"



1/1

AN381R

für Erwachsene
 for adults
 250 mm
 10"

Untersuchung - Diagnostik - Examination - Diagnostic

Zungenzangen Tongue Forceps

AN



AN706

1 Paar Ersatzgummi zu AN705R
1 pair of rubber pads for AN705R

YOUNG

AN705R

165 mm, 6 1/2"



AN709R

170 mm

6 3/4"



BH906R

160 mm

6 1/4"

COLLIN

AN709R-BH906R



HEYWOOD-SMITH

AN710R

200 mm, 8"



HEYWOOD-SMITH MODIF.

AN711R

215 mm, 8 1/2"

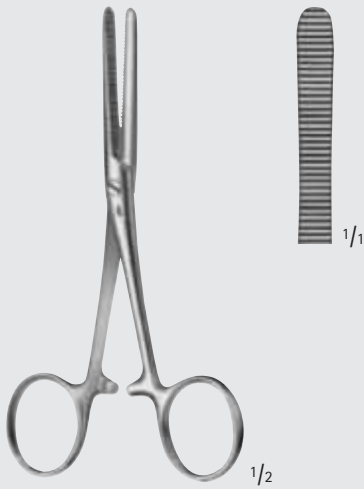

PEAN

BH410R

Schlauchklemme
 Tubing clamp forceps
 125 mm, 5"



KLINIKUM BERLIN

AN908R

Schlauchklemme
 starkes Modell, lange Sperre,
 daher Durchlauf dosierbar
 Tubing clamp
 heavy pattern, long ratchet,
 therefore passage adjustable
 145 mm, 5 3/4"



AN909R

Schlauchklemme
 sehr starkes Modell
 Tubing clamp forceps
 especially heavy pattern
 165 mm, 6 1/2"



AN910R

Schlauchklemme
 sehr starkes Modell
 Tubing clamp forceps
 especially heavy pattern
 165 mm, 6 1/2"

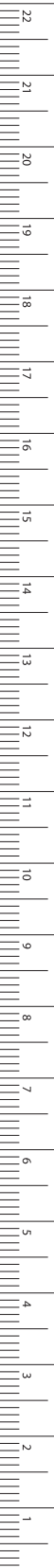

Untersuchung – Diagnostik – Examination – Diagnostic

Vorbereitung

Preparation

AN



AN911R

Schlauchklemme
Tubing clamp
180 mm, 7"



AN912R

Schlauchklemme
Tubing clamp
180 mm, 7"



AN913R

Schlauchklemme
Tubing clamp
200 mm, 8"



MD452R-MD454R

Schlauchklemmen
Tubing clamps





SAUERBRUCH

JG850R

Fasszange für verbrauchtes
Verbandmaterial und Tupfer

Operating Room

Pick-up forceps for used
tampons and dressings

550 mm, 22"

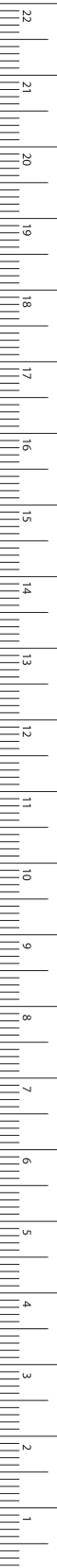

MILLIMETERS

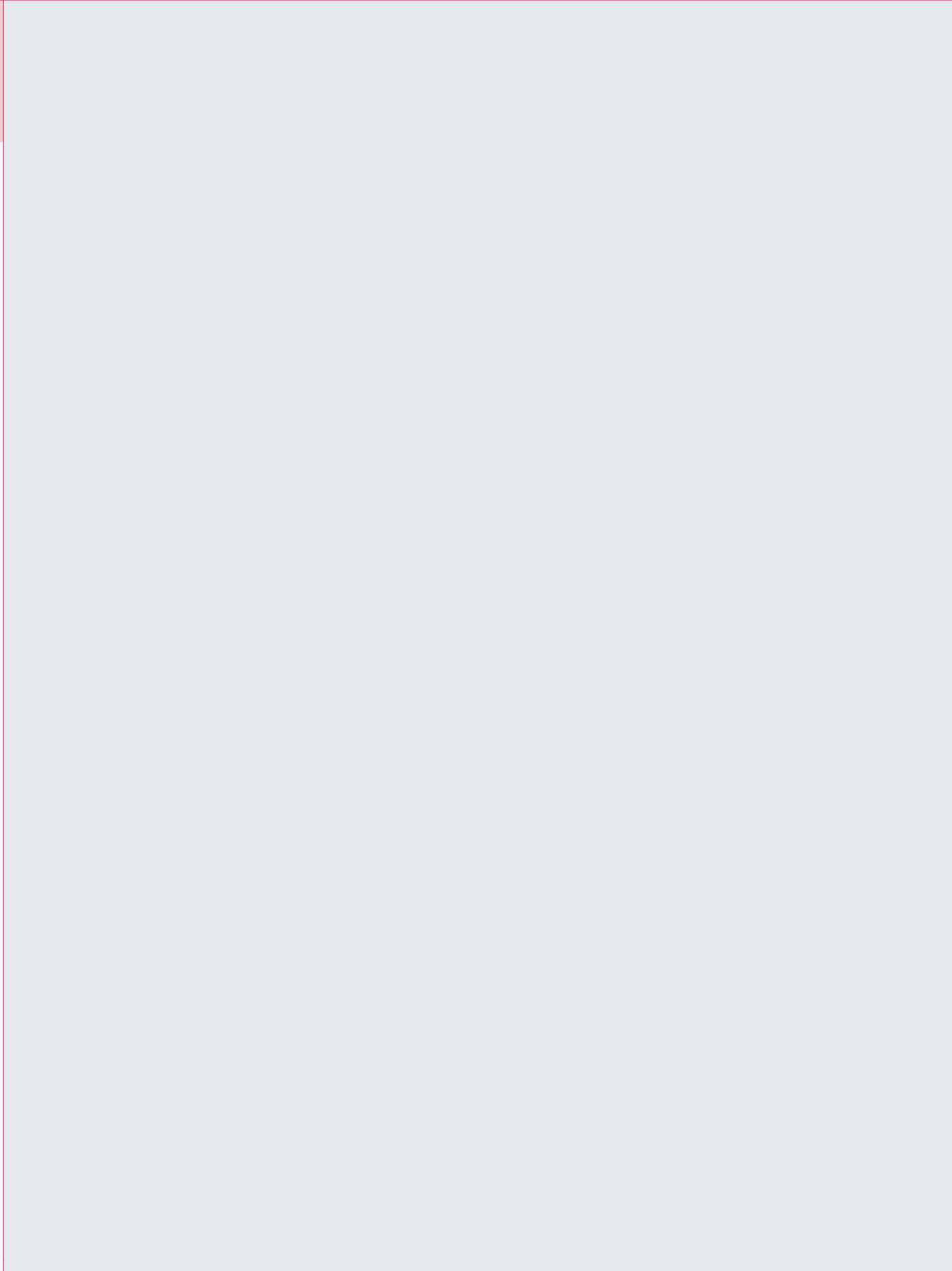

BA

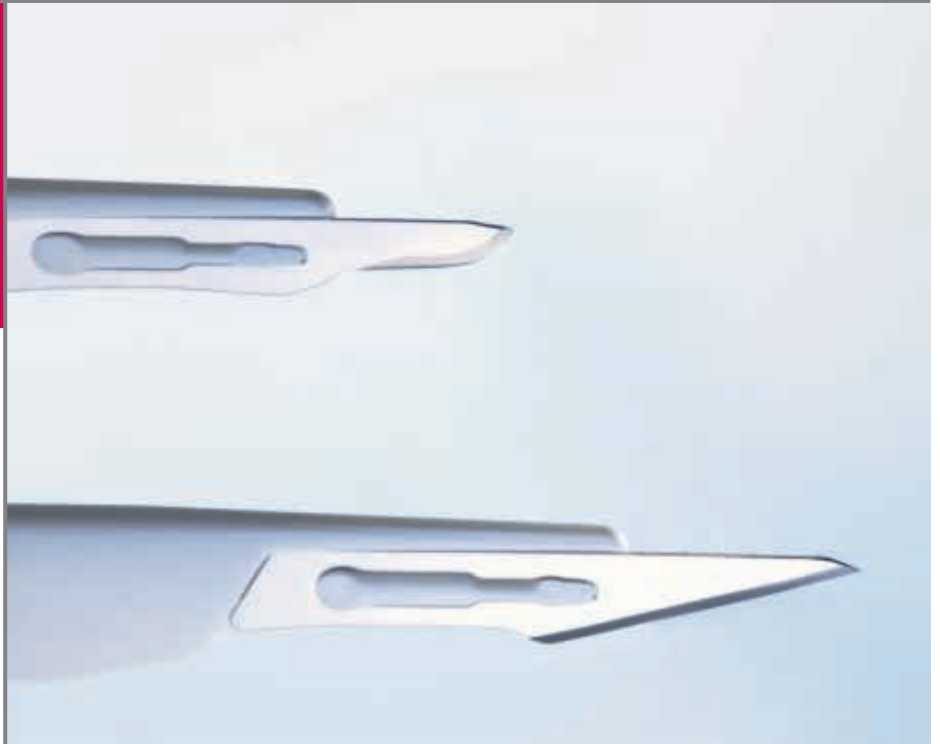

Sterilskalpelle, Skalpelle, Messer
Sterile Scalpels, Scalpels, Knives

Sterilskalpelle – Sterile Scalpels

Sterilskalpelle mit Kunststoffheft und Klingenschutz

Sterile Scalpels with Plastic Handle and Blade Protector

BA



1/1

Carbon Steel **BA210**
Stainless Steel **5518059**
Fig. 10



1/1

BA211
5518040
Fig. 11



1/1

BA212
5518105
Fig. 12



1/1

BA215
5518032
Fig. 15



1/1

BA215-1
Fig. 15



1/1

BA215-C
Fig. 15



1/1

BA218
Fig. 18





Sterilskalpelle – Sterile Scalpels

Sterilskalpelle mit Kunststoffheft und Klingenschutz
Sterile Scalpels with Plastic Handle and Blade Protector



1/1

Carbon Steel
Stainless Steel

BA219

Fig. 19



1/1

BA220

5518067

Fig. 20



1/1

BA221

5518075

Fig. 21



1/1

BA222

5518083

Fig. 22



1/1

BA223

5518016

Fig. 23



1/1

BA224

5518091

Fig. 24

BA

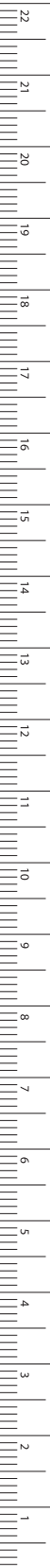

MILLIMETERS

BA210-BA224/5518016-5518105

Bestelleinheit:

PAK = Packung à 10 Stück

Sales unit:

PAK = Package of 10 pieces

Sterilskalpelle – Sterile Scalpels

Einmalskalpelle, Mikroskalpelle mit Plastikgriff

Scalpels for Single Use, Microsurgery Scalpels with Plastic Handle

Bestelleinheit:

PAK = Packung à 10 Stück

Sales unit:

PAK = Package of 10 pieces

Bestelleinheit:

PAK = Packung à 5 Stück

Sales unit:

PAK = Package of 5 pieces



BA311SU

Fig. 11
230 mm, 9"



BA323SU

Fig. 23
230 mm, 9"



1/1

BA364

165 mm, 6 1/2"



1/1

BA365

165 mm, 6 1/2"



1/1

BA367

165 mm, 6 1/2"

BA





Sterilskalpelle – Sterile Scalpels

Zeichenfeder
Mapping Pens

BA



1/1

ECKHOFF

BA704R

Zeichenfeder, komplett
Mapping pen, complete
145 mm, 5 3/4"



1/1

Bestelleinheit:
PAK = Packung à 12 Stück
Sales unit:
PAK = Package of 12 pieces

BA705

Zeichenfeder, allein
zum Einmalgebrauch
Nib, only
for single use



AD099R

Metallgefäß für
Markierungsflüssigkeit
Metal ink pot



MILLIMETERS

Sterilskalpelle – Sterile Scalpels

Skalpelle
Scalpels

BA



BA401R

BA402R

BA403R

BA407R

BA408R

BA409R

BA401R-BA409R

130 mm, 5 1/8"



BERGMANN

BA451R

140 mm, 5 1/2"



Sterilskalpelle – Sterile Scalpels

Skalpelle, Tenotome

Scalpels, Tenotomes

BA



BA501R

BA503R

BA504R

BA506R

BA507R

BA508R

BA509R

BA546R

BA514R

BA563R

Tenotom
Tenotome

BA501R-BA563R

140 - 175 mm, 5 1/2 - 7"

MILLIMETERS

Sterilskalpelle – Sterile Scalpels

Amputationsmesser

Amputation Knives

BA



doppelschneidig
double cutting

LISTON

FH100R-FH103R

Amputationsmesser
Amputation knives

	FH100R	FH101R	FH102R	FH103R
--	--------	--------	--------	--------

Schnittlänge: 130 mm 160 mm 190 mm 220 mm

Blade length: 5 1/8" 6 1/4" 7 1/2" 8 3/4"



doppelschneidig
double cutting

CATLIN

FH116R

Amputationsmesser
Amputation knife

Schnittlänge: 160 mm

Blade length: 6 1/4"



LANGENBECK

FH150R

Lappenmesser
Flap knife

Schnittlänge: 120 mm

Blade length: 6 1/4"



Sterilskalpelle – Sterile Scalpels
 Amputations- und Resektionsmesser
 Amputation- and Resection Knives

BA



1/2

FH160R

Phalangenmesser
Phalangeal knife

Schnittlänge: 105 mm
Blade length: 4 1/8"



1/2

FH166R

Zwischenknochenmesser
Interosseous knife

Schnittlänge: 110 mm
Blade length: 4 3/8"

doppelschneidig
double cutting



1/2

FH170R

Beinhautmesser
mit Schaber
Periosteum knife
with raspatory

Schnittlänge: 65 mm
Blade length: 2 1/2"



1/2

LANGENBECK

FH191R-FH192R
Resektionsmesser
Resection knives

Schnittlänge: 55 mm
Blade length: 2 1/8"



FH191R



FH192R

1/1



MILLIMETERS

Sterilskalpelle – Sterile Scalpels

Fistelmesser

Fistula Knives

BA



1/1

SIMON

BA604R-BA606R

200 mm, 8"



BA604R



BA605R



1/1

BA606R



1/1

ULRICH

BA611R

225 mm, 9"



Sterilskalpelle – Sterile Scalpels

Trigeminus- und Tonsillenmesser
Trigeminal- and Tonsil Knives

BA



1/1

OLIVECRONA

BA646R

Trigeminusmesser
Trigeminal knife
205 mm, 8"



1/1

BA641R

Trigeminusmesser
Trigeminal knife
230 mm, 9"



1/1

FOWLER

OM680R

Tonsillenmesser
Tonsil knife
200 mm, 8"



1/1

ABRAHAM

OM681R

Tonsillenmesser
Tonsil knife
215 mm, 8 1/2"

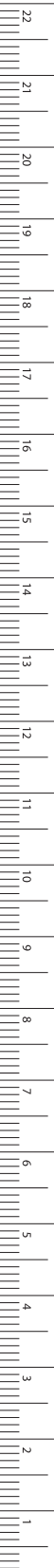

MILLIMETERS

Sterilskalpelle – Sterile Scalpels

Skalpelle
Scalpels

Meniskusmesser siehe Rubrik FO

Meniskus knives see section FO

BA



MASING

OL114R

Knorpelritzmesser,
in der Spitze gebogen
Cartilage slitting knife,
curved blade, pointed
130 mm, 5 1/8"

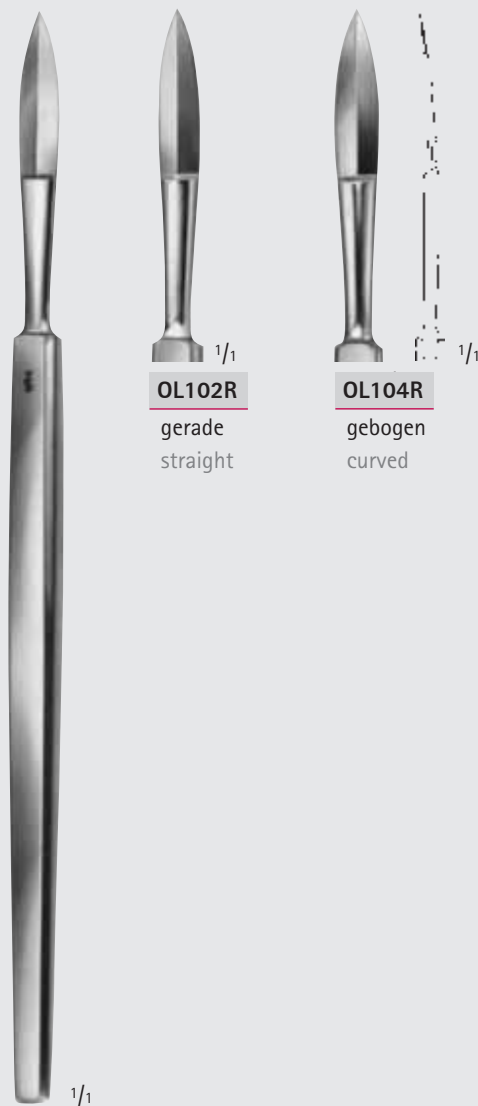

OL102R

gerade
straight

OL104R

gebogen
curved

JOSEPH

OL102R-OL104R

Plastikmesser
Double-edged nasal knives,
pointed
145 mm, 5 3/4"



Sterilskalpelle – Sterile Scalpels

Sterilisierrahmen, Hautstanzen
Sterilizing Racks, Dermal Punches

BA

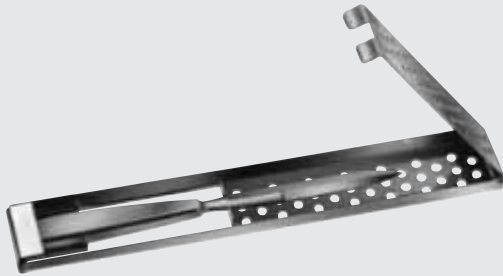

FH194R

Sterilisierrahmen für 1 Messer
mit Schnittlänge bis 140 mm
Sterilizing rack for 1 knife
with length of blade up to 140 mm
290 x 40 x 14 mm

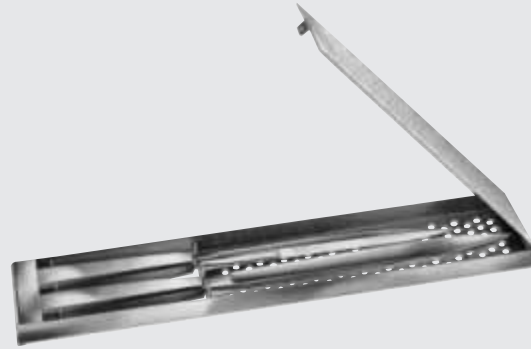

FH197R

Sterilisierrahmen für 2 Messer
mit Schnittlängen bis 190 mm
Sterilizing rack for 2 knives
with length of blade up to 190 mm
335 x 65 x 14 mm

FH194R-FH197R

für Resektions- und Amputationsmesser
for Resection- and Amputation knives



○ 1/1

OL652R

Ø 2 mm
diam. 2 mm

○ 1/1

OL653R

Ø 3 mm
diam. 3 mm

○ 1/1

OL654R

Ø 4 mm
diam. 4 mm

○ 1/1

OL656R

Ø 6 mm
diam. 6 mm

○ 1/1

OL657R

Ø 7 mm
diam. 7 mm

KEYES

OL652R-OL657R

Hautstanzen
Dermal punches
100 mm, 4"



KEYES MODIF.

OL670R

Hautstanze, komplett,
mit 5 austauschbaren Aufsätzen, Griff und Gestell
Dermal punch, complete
with 5 interchangeable tips, handle and rack



MILLIMETERS

Sterilskalpelle – Sterile Scalpels

Handdermatome

Skin Grafting Knives

BA



GOULIAN

BA710R

Dermatom mit 3 Schnittschablonen in den Stärken 0,20, 0,25 und 0,30 mm, kpl. mit 5 Klingen BA711R
Dermatome with 3 grafting templates 0.20, 0.25 and 0.30 mm thick, complete with 5 blades BA711R
180 mm, 7"

BA711R

Ersatzklingen, unsteril
Bestelleinheit:
PAK = Packung à 50 Stück
Spare blades, non sterile
Sales unit:
PAK = Package of 50 pieces



SCHINK

BA706R

Dermatom, einstellbar von 0,1 bis 2,0 mm, komplett, mit 1 auswechselbaren Klinge und 2 Spannplatten
Dermatome, adjustable from 0.1 to 2.0 mm, complete, with 1 interchangeable blade and 2 skin straightening plates
300 mm, 12"

BA708R

Ersatzklinge allein
Spare blade only

BA709R

Spannplatte allein
Skin straightening plate only

Sterilskalpelle – Sterile Scalpels

Handdermatome

Skin Grafting Knives



SILVER

BA715R

Dermatom,
ohne Klängen
Skin graft knife,
without blade
190 mm, 7 1/2"

BA716R

Ersatzklinge, unsteril
Bestelleinheit:
PAK = Packung à
5 Stück
Spare blade, non sterile
Sales unit:
PAK = Package of
5 pieces



Stange starr / bar fixed

WATSON

BA719R

Dermatom,
ohne Klängen
Skin graft knife,
without blade
300 mm, 12"

BA718R

Ersatzklinge, steril
Bestelleinheit:
PAK = Packung à
10 Stück
Spare blade, sterile
Sales unit:
PAK = Package of
10 pieces



Stange nur oszillierend / bar only oscillating

COBBETT

BA717R

Dermatom,
ohne Klängen
Skin graft knife,
without blade
315 mm, 12"

BA718R

Ersatzklinge, steril
Bestelleinheit:
PAK = Packung à
10 Stück
Spare blade, sterile
Sales unit:
PAK = Package of
10 pieces



Stange oszillierend und drehend / bar oscillating and rotating

BRAITHWAITE

BA712R

Dermatom,
ohne Klängen
Skin graft knife,
without blade
315 mm, 12"

BA718R

Ersatzklinge, steril
Bestelleinheit:
PAK = Packung à
10 Stück
Spare blade, sterile
Sales unit:
PAK = Package of
10 pieces



HUMBY

BA713R

Dermatom,
ohne Klängen
Skin graft knife,
without blades
365 mm, 13 3/4"

BA714R

Ersatzklinge, steril
Bestelleinheit:
PAK = Packung à
10 Stück
Spare blade, sterile
Sales unit:
PAK = Package of
10 pieces

BA

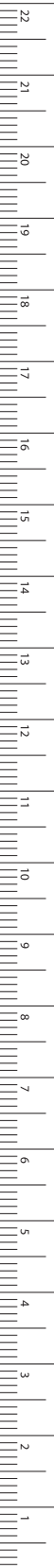

MILLIMETERS

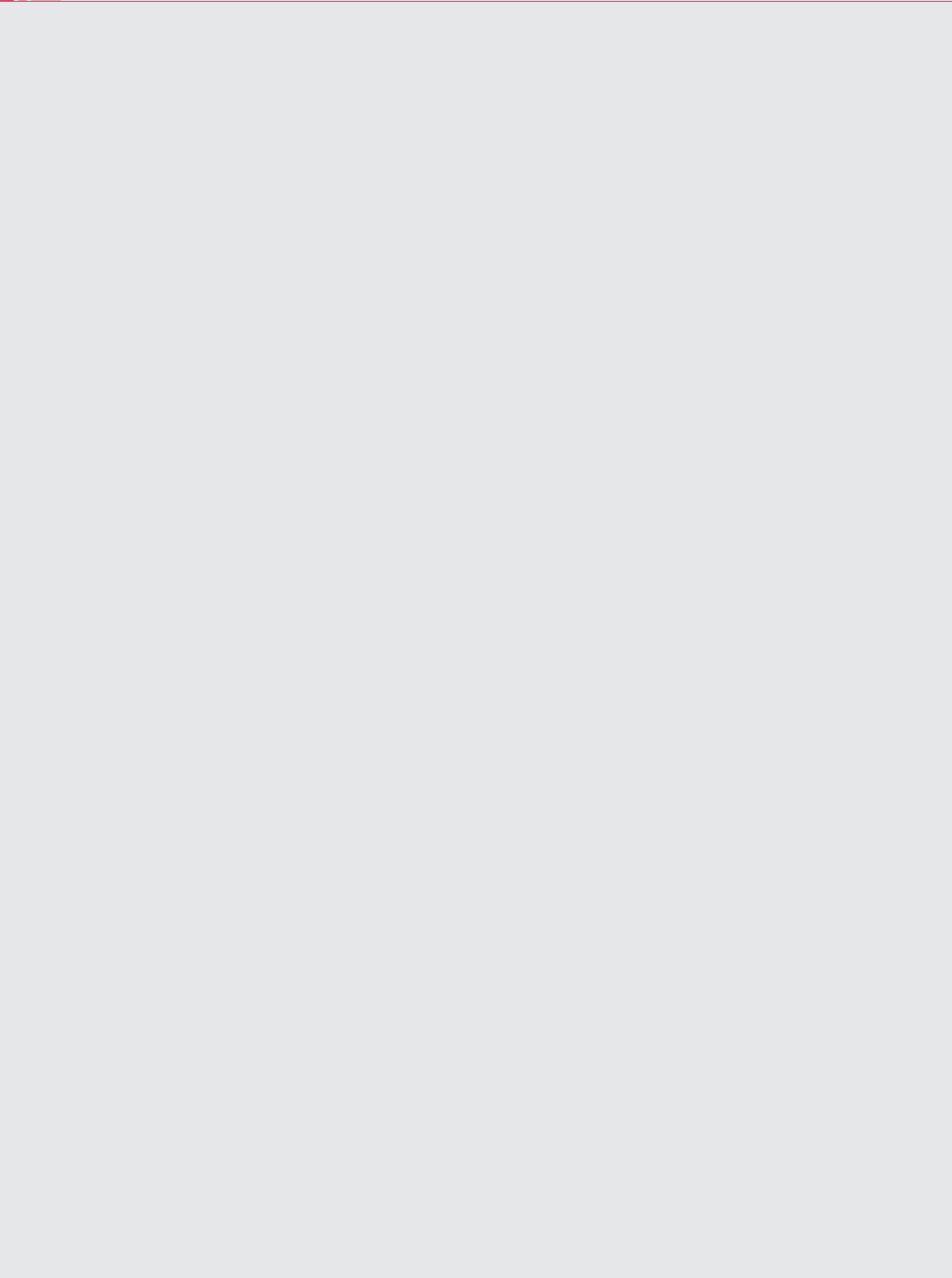

BB

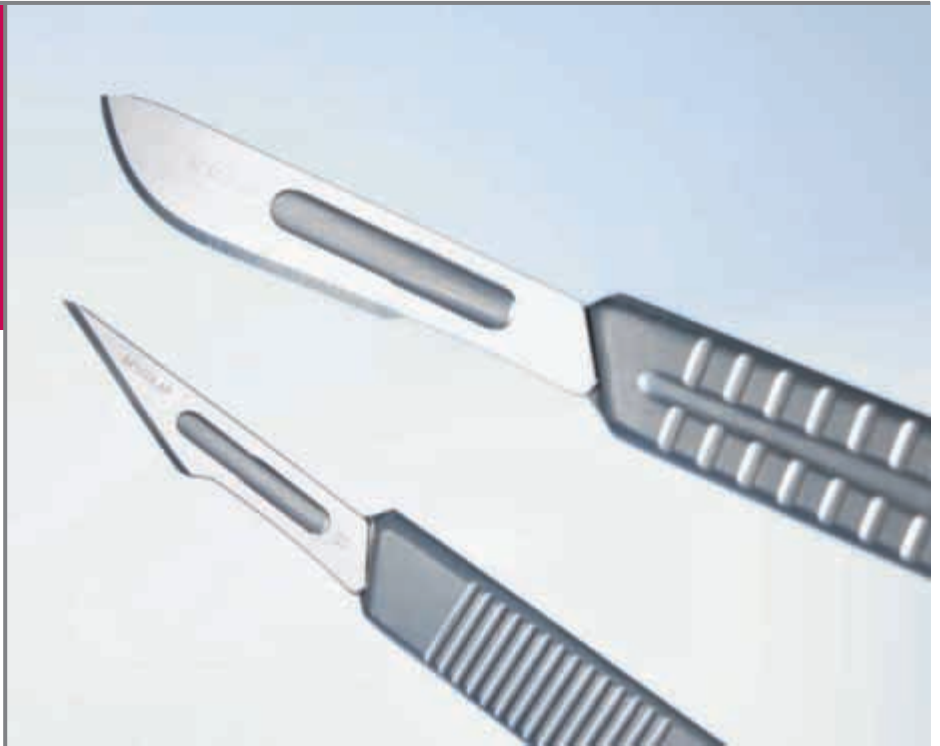

Skalpellklingen und Griffe
Scalpel Blades and Handles

Skalpellsklingen und Griffe – Scalpel Blades and Handles

Skalpellsgriffe
Scalpel Handles

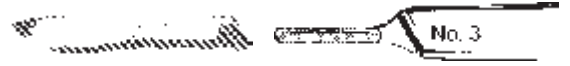

Für Klingen Fig. 10 - 15 und Fig. 40, 42
For blades fig.10 - 15 and fig. 40, 42

BB

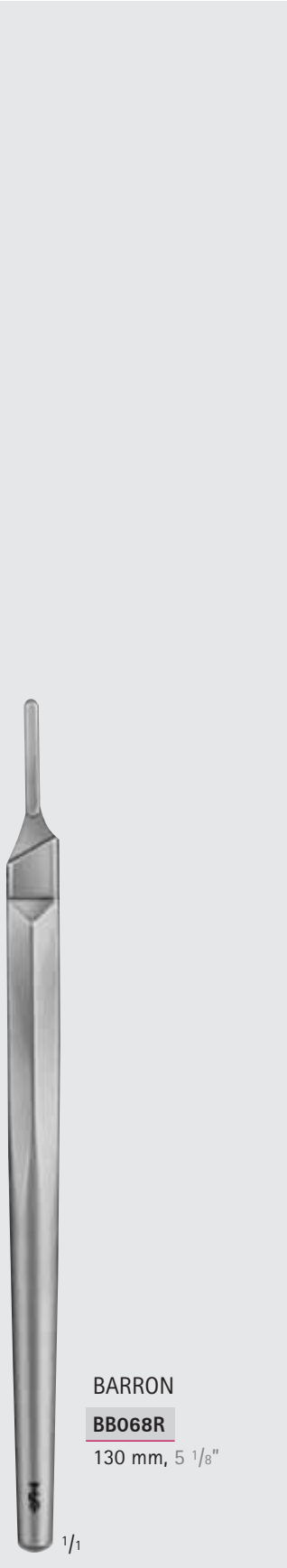

BARRON
BB068R
130 mm, 5 1/8"

1/1



BB073R
No. 3
125 mm, 5"

1/1



BB074R
No. 3
125 mm, 5"

1/1

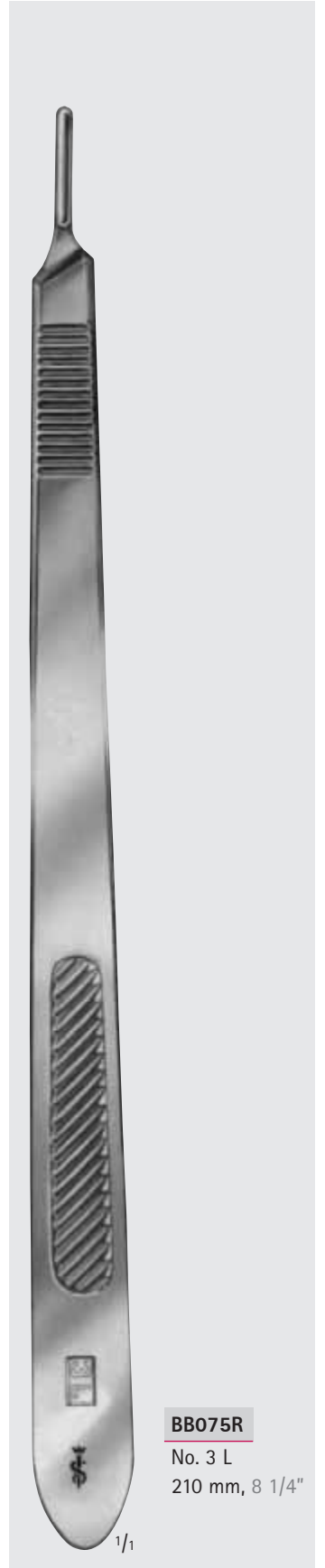

BB075R
No. 3 L
210 mm, 8 1/4"

1/1



Skalpellsklingen und Griffe – Scalpel Blades and Handles

Skalpellsgriffe
Scalpel Handles



Für Klingen Fig. 10 - 15 und Fig. 40, 42
For blades fig.10 - 15 and fig. 40, 42

BB



BB175R
No. 3 XL
250 mm, 10"



BARRÉ

BB176R-BB178R

No. 3 XL
für linke Hand
for left hand
250 mm, 10"



BB177R



BB176R
12°



BB178R
25°



entspricht der
englischen
No. 5
corresponds
with english
No. 5

BB077R
No. 7
160 mm, 6 1/4"

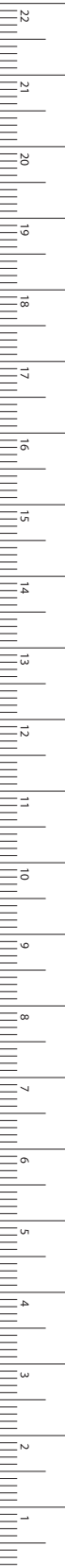

MILLIMETERS

Skalpellklingen und Griffe – Scalpel Blades and Handles

Skalpellgriffe

Scalpel Handles



Für Klingen Fig. 10 - 15 und Fig. 40, 42

For blades fig. 10 - 15 and fig. 40, 42

BB



BB078R

225 mm, 9"



BB079R

225 mm, 9"

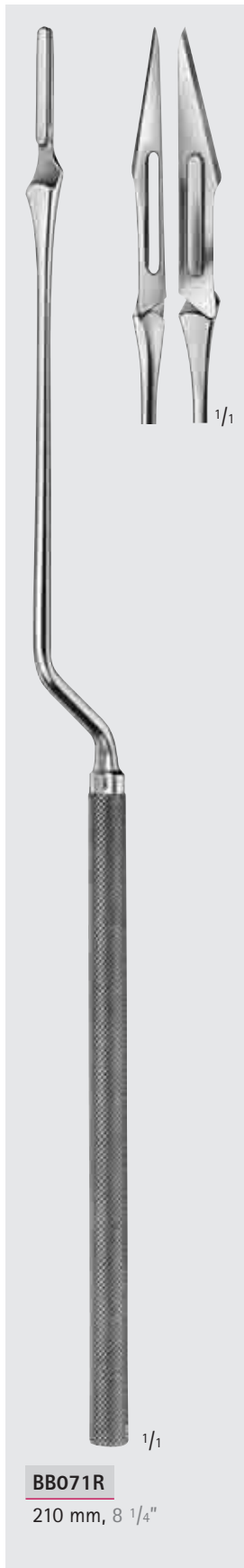

BB071R

210 mm, 8 1/4"



BB070R

155 mm, 6"

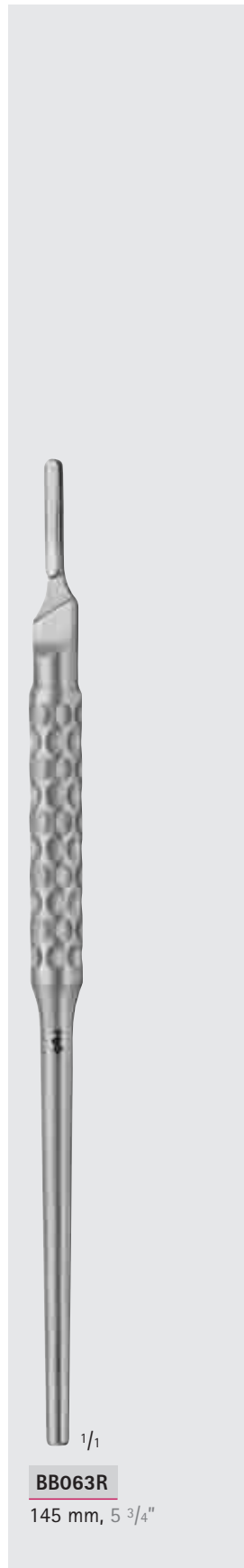

BB063R

145 mm, 5 3/4"



Skalpellklingen und Griffe – Scalpel Blades and Handles

Skalpellgriffe
Scalpel Handles



Für Klingen Fig. 18 - 36
For blades fig. 18 - 36

BB



BB084R

No. 4
135 mm, 5 1/4"



BB085R

No. 4 L
215 mm, 8 1/2"



BB087R

No. 4 XL
250 mm, 10"



BB080R

No. 4
225 mm, 9"



BB088R

No. 8
130 mm, 5 1/8"



BB089R

145 mm, 5 3/4"



MILLIMETERS

Skalpellsklingen und Griffe – Scalpel Blades and Handles

Sterilklingen Sterile Scalpel Blades



vakuum vergütet
heat-treated in vacuum

steril
sterile



BB



1/1

Carbon Steel
Stainless Steel

BB510
16600495



1/1

BB511
16600509



1/1

BB512
16600517



1/1

BB513
16615492



1/1

BB515
16600525



1/1

Carbon Steel

BB515-1



1/1

BB515-C



1/1

BB540
doppelschneidig
double cutting



1/1

BB542
doppelschneidig
double cutting

passend zu den Griffen auf Seite 38 - 40
Bestelleinheit:
PAK = Packung à 100 Stück
in Spenderpackung
fitting handles on page 38 - 40
Sales unit:
PAK = Package of 100 pieces
in dispenser package

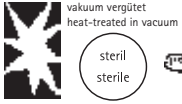

Skalpellsklingen und Griffe – Scalpel Blades and Handles

Sterilklingen, Fadenmesser
Sterile Scalpel Blades, Stitch-Cutter

BB

	1/1	1/1	1/1	1/1	1/1	1/1	1/1	1/1	1/1
Carbon Steel	BB518	BB519	BB520	BB521	BB522	BB523	BB524	BB525	BB536
Stainless Steel	16600541	16615514	16600550	16600568	16600576	16600584	16600592	16616634	16615522



passend zu den Griffen auf Seite 41

Bestelleinheit:

PAK = Packung à 100 Stück
in Spenderpackung

fitting handles on page 41

Sales unit:

PAK = Package of 100 pieces
in dispenser package



1/1

Carbon Steel	BB500
Stainless Steel	16600487

Fadenmesser
Stitch-cutter

Bestelleinheit:

PAK = Packung à 100 Stück

Sales unit:

PAK = Package of 100 pieces

Skalpellsklingen und Griffe – Scalpel Blades and Handles

Skalpellsgriffe, rund, für mikrochirurgische Klappen

Scalpel Handles, Round, for Microsurgery Blades

BB



1/1

BB046R

135 mm, 5 1/2"



1/1

BB048R

155 mm, 6"



1/1

CASPAR

BB052R

180 mm, 7"



1/1

BB054R

200 mm, 8"

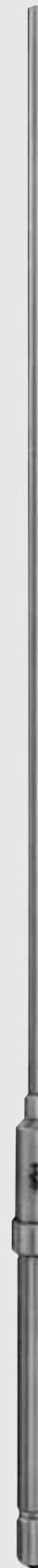

2/3

BB060R

330 mm, 12"



stainless steel
steril sterile

Skalpellschneidmesser und Griffe – Scalpel Blades and Handles

Skalpellschneidmesser für mikrochirurgische Klappen – Mikrochirurgische Klappen

Scalpel Handles for Microsurgery Blades – Microsurgery Blades

BB

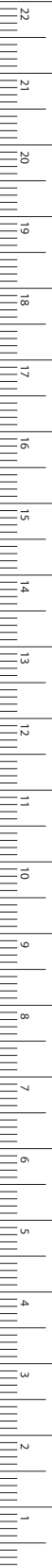

LANDOLT
BB057R
Skalpellschneidmessergriff, bajonettförmig, rund
Scalpel handle, bayonet-shaped, round
250 mm, 10"

LANDOLT
BB053R
Skalpellschneidmessergriff, bajonettförmig, 4-Kant
Scalpel handle, bayonet-shaped, square shank
1/1 210 mm, 8 1/4"

BB331R
PAK = Packung à 10 Stück
PAK = Package of 10 pieces

BB332R
PAK = Packung à 10 Stück
PAK = Package of 10 pieces

BB361R
PAK = Packung à 10 Stück
PAK = Package of 10 pieces

BB362R
PAK = Packung à 10 Stück
PAK = Package of 10 pieces

BB363R
ST = Packung à 1 Stück
ST = Package of 1 piece

BB364R
PAK = Packung à 10 Stück
PAK = Package of 10 pieces

BB365R
PAK = Packung à 10 Stück
PAK = Package of 10 pieces

BB366R
ST = Packung à 1 Stück
ST = Package of 1 piece

BB367R
PAK = Packung à 10 Stück
PAK = Package of 10 pieces

BB368R
PAK = Packung à 10 Stück
PAK = Package of 10 pieces

BB369R
ST = Packung à 1 Stück
ST = Package of 1 piece

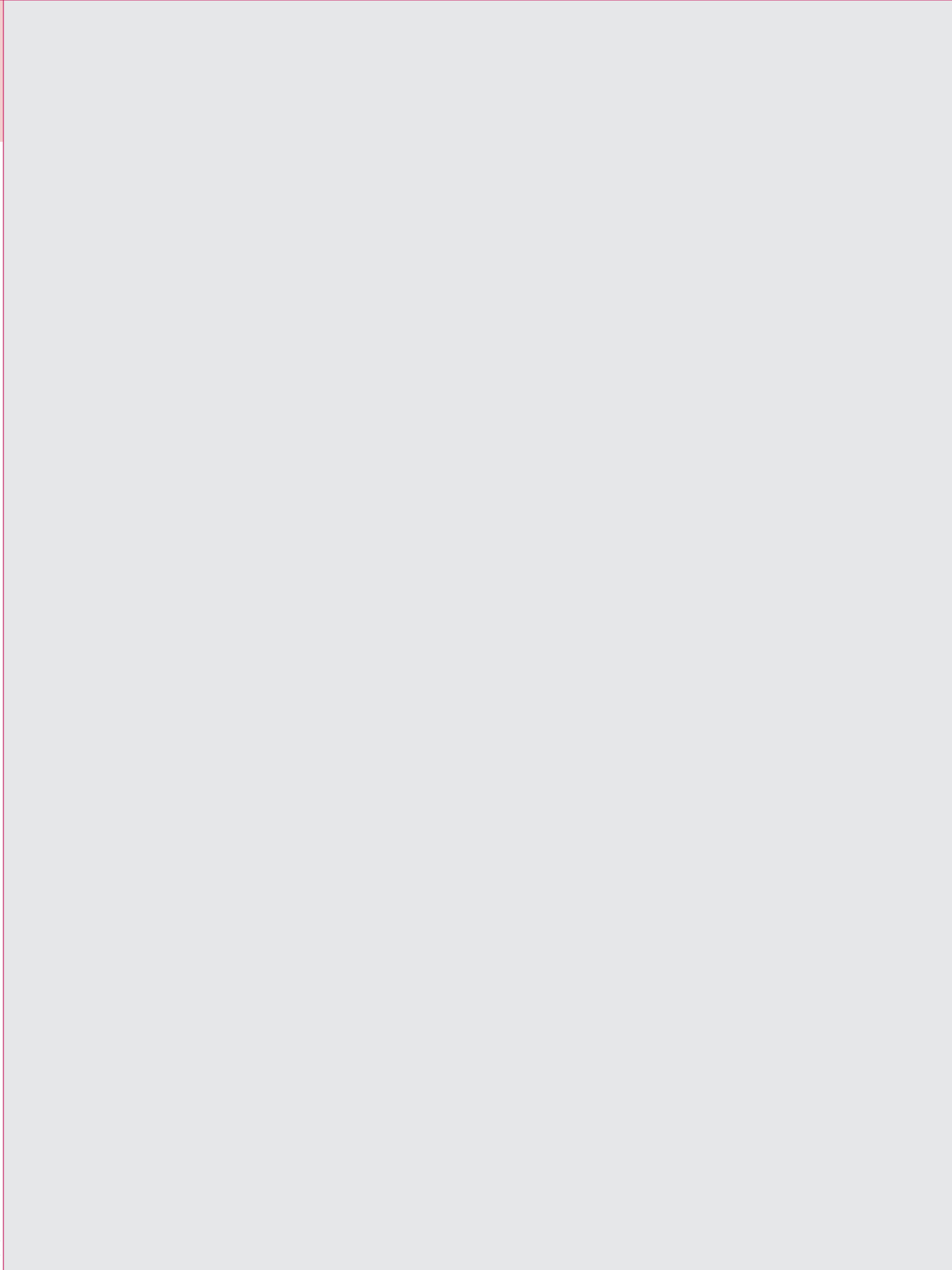



BC



Scheren
Scissors

Scheren – Scissors

Mikro-Federscheren mit Flachgriff

Micro Scissors (Spring Type) with Flat Handles

BC

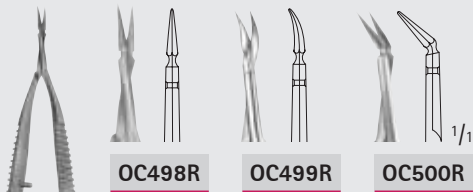

VANNAS

OC498R-OC500R

85 mm, 3 3/8"

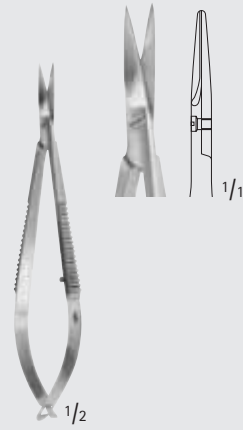

OC480R

95 mm, 3 3/4"

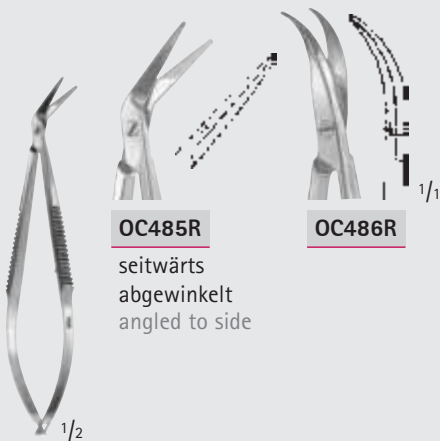

CASTROVIEJO

OC485R-OC486R

95 mm, 3 3/4"

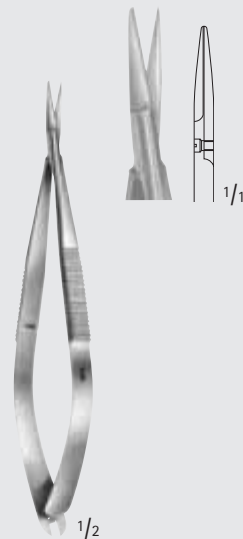

OC482R

125 mm, 5"





Scheren – Scissors

Mikro-Federscheren mit Flachgriffen
Micro Scissors (Spring Type) with Flat Handles

BC

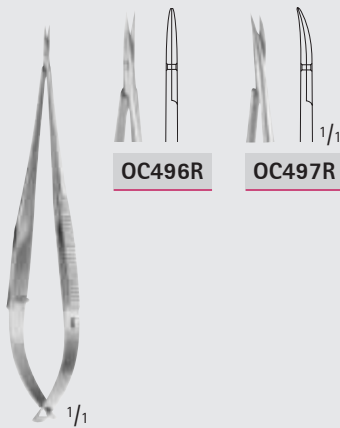

OC496R

OC497R

OC496R-OC497R

105 mm, 4 1/8"

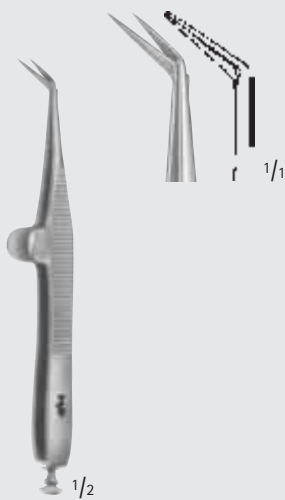

WECKER

OC461R

Augenschere

Eye scissors

110 mm, 4 1/2"

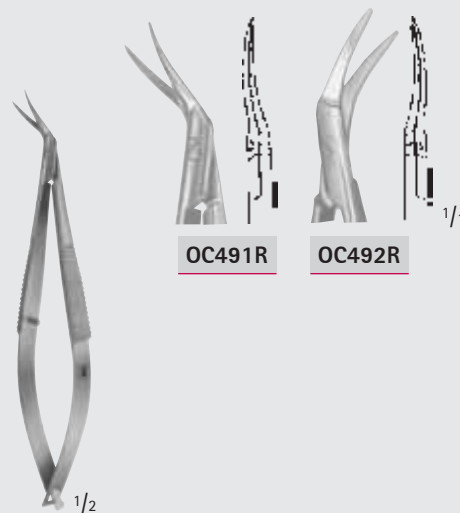

OC491R

OC492R

CASTROVIEJO

OC491R-OC492R

Augenscheren

Eye scissors

110 mm, 4 3/8"



MILLIMETERS

Scheren – Scissors

Mikro-Federscheren mit Flachgriffen und Karoprofil

Micro Scissors (Spring Type) with Flat Handles and Cross-Serration



... mit Flachgriffen und Karoprofil

- breite Flachgriffe mit griffigem Karoprofil
- sichere Handhabung

... with flat handle and cross-serration

- flat handles, sure grip due to cross-serration

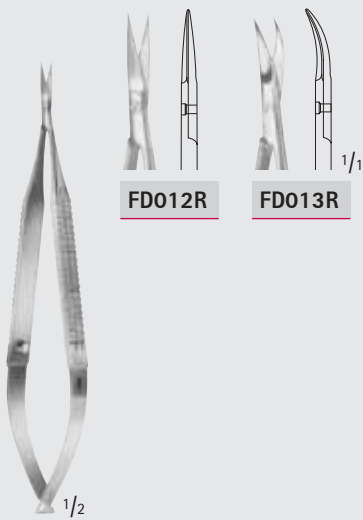

FD012R

FD013R

FD012R-FD013R

120 mm, 4 3/4"

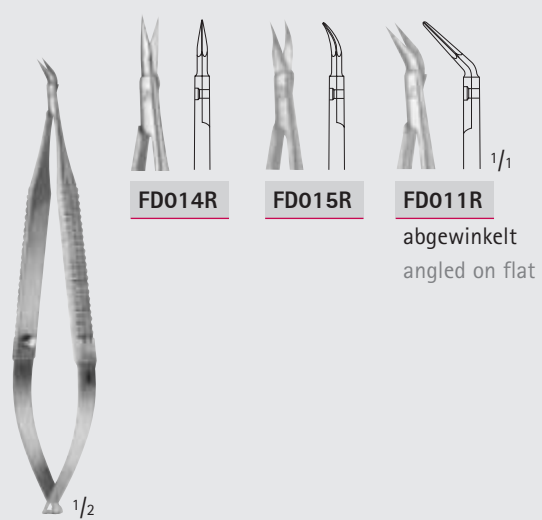

FD014R

FD015R

FD011R

abgewinkelt
angled on flat

VANNAS

FD011R-FD015R

120 mm, 4 3/4"



Scheren – Scissors

Mikro-Federscheren mit Flachgriffen und Karoprofil
Micro Scissors (Spring Type) with Flat Handles and Cross-Serration



Venenschere FD028R
zum Auffrischen von Gefäßstümpfen

- kein Abgleiten des Gefäßes
- glatte, saubere Durchtrennung

Vein scissors FD028R
for roughening vessel ends

- vessel cannot slip off
- clean, smooth cut



BIEMER

FD028R

Venenschere
Vein scissors
130 mm, 5 1/8"

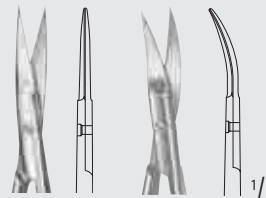

FD016R

FD017R



FD016R-FD017R

160 mm, 6 1/4"

BC

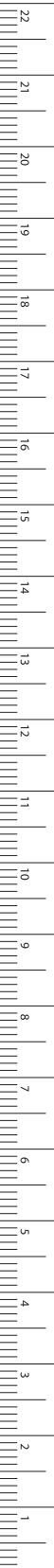

MILLIMETERS

Scheren – Scissors

Mikro-Federscheren mit Flachgriffen und Karoprofil

Micro Scissors (Spring Type) with Flat Handles and Cross-Serration

BC

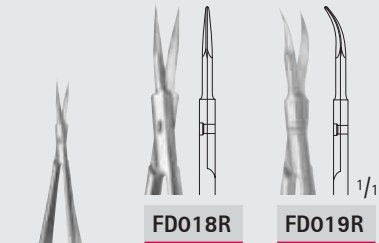

VANNAS

FD018R-FD019R

160 mm, 6 1/4"

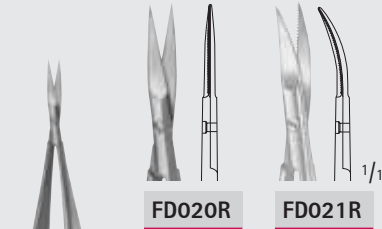

MILLESi

FD020R-FD021R

Schneiden gezahnt
Blades serrated
160 mm, 6 1/4"

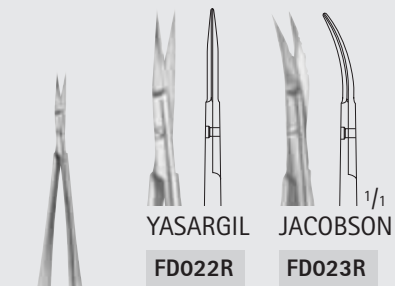

YASARGIL

FD022R-FD023R

185 mm, 7 1/4"

Scheren – Scissors

Mikro-Federscheren mit Rundgriffen
Micro Scissors (Spring Type) with Round Handles

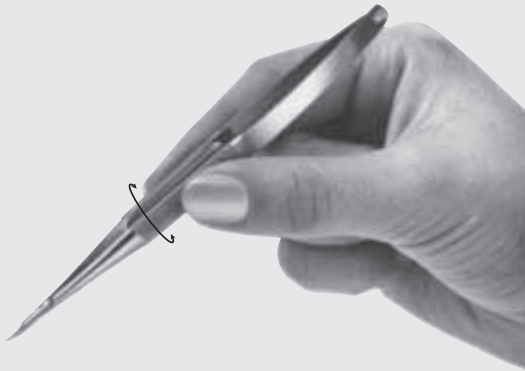

... mit Rundgriffen

- Rundgriffe erlauben Drehbewegungen zwischen den Fingern.
- Optimale Balance, individuell je nach Instrument, durch volle oder gehöhlte Griffpartien.

... with round handles

- Round handles allow turning manipulations between the fingers.
- Optimum balance individually for each instrument due to solid or hollowed-out handles.

BC

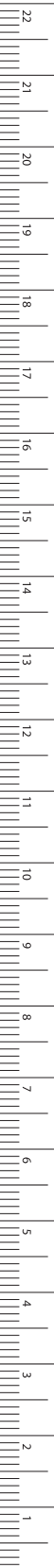

FD100R

FD101R

FD103R

Mikro-Präparierschere
Micro dissecting scissors

FD100R-FD103R

145 mm, 5 3/4"

MILLIMETERS

Scheren – Scissors

Mikro-Federscheren mit leichtem Kunststoffprofil
Micro Scissors (Spring Type) with Light Plastic Handle



Das MÜLLER Mikro-Instrumentarium

Ein hochwertiges Set für die periphere Mikrochirurgie. Zahlreiche praxisbewährte Details führen zu mehr Effektivität und Sicherheit.

■ Unverkrampte Haltung = mehr Feingefühl

Das leichte Kunststoffprofil vergrößert die Griffoberfläche, gewährleistet dadurch eine unverkrampte Handhaltung und verleiht mehr Feingefühl.

■ Leichteres Drehen = erweiterter Arbeitsbereich

Der runde Griffquerschnitt ermöglicht leichtes, gleichmäßiges Drehen des Instrumentes. Verwendungs- bzw. Arbeitsbereich wird dadurch erweitert.

■ Sicherer Halt

Das griffige Noppenprofil gewährleistet einen durchweg sicheren Halt bei sämtlichen Bewegungsabläufen.

■ Optimales Handling

Eine Entwicklung nach ergonomischen Gesichtspunkten, verbunden mit dem geringen Gewicht der neuen Kunststoffgriffe schaffen die Voraussetzung zu ermüdungsfreiem Arbeiten und optimalem Handling.

The MÜLLER Micro instrument system

A top quality set for peripheral microsurgery. Numerous details tried and tested in practice mean increased efficiency and safety.

■ Natural holding position = increased sensitivity

The light plastic profile increases the grip surface, thus guaranteeing a natural hand position without cramping and providing enhanced sensitivity.

■ Easier rotation = extended working area

The round grip cross section permits easy and uniform rotation of the instrument. This extends the application and working areas.

■ Safe grip

The easy grip studded profile guarantees a secure hold for all movements.

■ Optimum handling

Development in accordance with ergonomic criteria and the low weight of the new plastic grips provide fatiguefree working and optimum handling.



Scheren – Scissors

Mikro-Federschere mit leichtem Kunststoffprofil
Micro Scissors (Spring Type) with Light Plastic Handle

BC



MÜLLER

FM010R-FM014R

120 mm, 4 3/4"



FM010R

spitz/spitz
sharp/sharp



FM011R

spitz/spitz
sharp/sharp



FM012R

spitz/stumpf
sharp/blunt



FM013R

stumpf/stumpf
blunt/blunt



FM014R

Kugel/spitz
probe pointed/sharp



MÜLLER

FM040R-FM041R

170 mm, 6 3/4"



FM040R

spitz/spitz
sharp/sharp



FM041R

spitz/spitz
sharp/sharp



MILLIMETERS

Scheren – Scissors

Mikro-Federschere mit Flachgriff

Micro Scissors with Flat Handle

BC



165 mm, 6 1/2"

1/1



Scheren – Scissors

Mikro-Federscheren mit Flachgriff

Micro Scissors with Flat Handle

25°

**FM470R**

45°

**FM471R**

60°

**FM472R**

90°

**FM473R**

125°

**FM474R**gerade
straightaufgebogen
curved
on flatFeines Blatt
Fine blade**FM451R****FM452R****FM453R****FM454R****FM455R**Feines Blatt,
1 Blatt mit Knopf
Fine blade,
with 1 probe
pointed blade**FM437R****FM438R****FM439R****FM440R****FM441R****FM442R****FM436R**Sehr feines Blatt
Delicate blade**FM431R****FM432R****FM433R****FM434R****FM435R****FM444R****FM430R**Extrem feines Blatt
Ultra delicate blade

BC

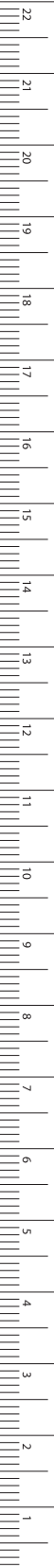

MILLIMETERS

Scheren – Scissors

Mikro-Federscheren mit Rundgriff

Micro Scissors (Spring Type) with Round Handle

BC

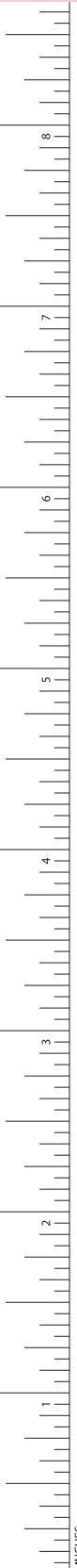

165 mm, 6 1/2"

1/1



Scheren – Scissors

Mikro-Federschere mit Rundgriff
Micro Scissors with Round Handle

25°



FM476R

45°



FM477R

60°



FM478R

90°



FM479R

125°



FM480R

gerade
straight

aufgebogen
curved
on flat

Feines Blatt
Fine blade



FM482R



FM483R



FM484R



FM485R



FM486R



FM488R



FM481R

Sehr feines Blatt
Delicate blade



FM489R



FM490R



FM491R



FM492R



FM493R

Sehr feines Blatt,
1 Blatt mit Knopf
Delicate blade,
with 1 probe
pointed blade



FM504R



FM505R



FM506R



FM507R



FM508R



FM503R

Extrem feines Blatt
Ultra delicate blade

BC

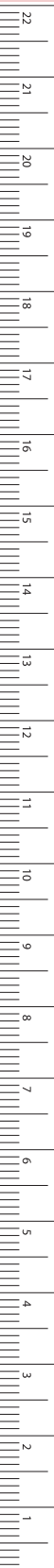

MILLIMETERS

Scheren – Scissors

Mikro-Federscheren mit Rundgriff

Micro Scissors (Spring Type) with Round Handles

BC

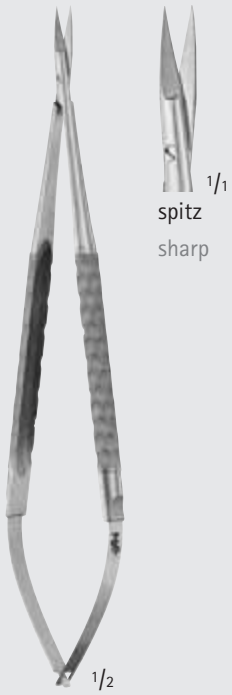

FM042R

Mikro-Schere
Micro scissors
180 mm, 7"



FD251R

Mikro-Schere
Micro scissors
180 mm, 7"



FM043R

Mikro-Schere
Micro scissors
180 mm, 7"



FD252R

Mikro-Fadenschere
für Nahtmaterial von 6/0 und kleiner - 8/0 und kleiner
Micro ligature scissors
for suture material 6/0 and smaller - 8/0 and smaller
180 mm, 7"



Scheren – Scissors

Feine Scheren – große Ringform
Delicate Scissors – Large Ring Design

BC

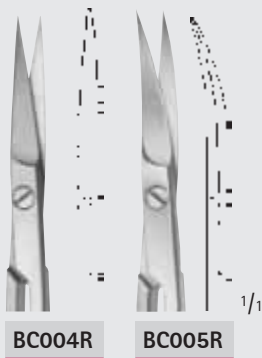

BC004R

BC005R

BC004R-BC005R

115 mm, 4 1/2"

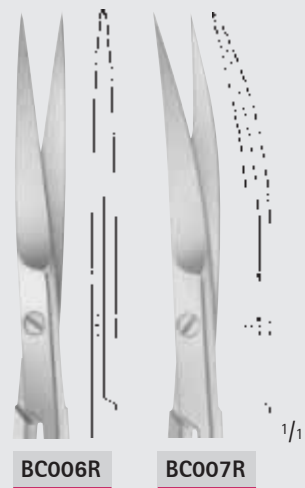

BC006R

BC007R

JOSEPH

BC006R-BC007R

150 mm, 6"



MILLIMETERS

Scheren – Scissors

Feine Scheren – große Ringform

Delicate Scissors - Large Ring Design

BC



BC008R

spitz
sharp



BC009R

spitz
sharp



BC010R

stumpf
blunt



BC011R

stumpf
blunt

STEVENS

BC008R-BC011R

Präparierscheren

Dissecting scissors

115 mm, 4 1/2"



BC020R

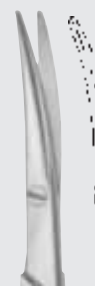

BC021R

BC020R-BC021R

Präparier- und Strabismusscheren

Dissecting- and strabismus scissors

115 mm, 4 1/2"



BC022R



BC023R

METZENBAUM

BC022R-BC023R

Präparierscheren

Dissecting scissors

145 mm, 5 3/4"

Scheren – Scissors

Feine Scheren – große Ringform
Delicate Scissors – Large Ring Design

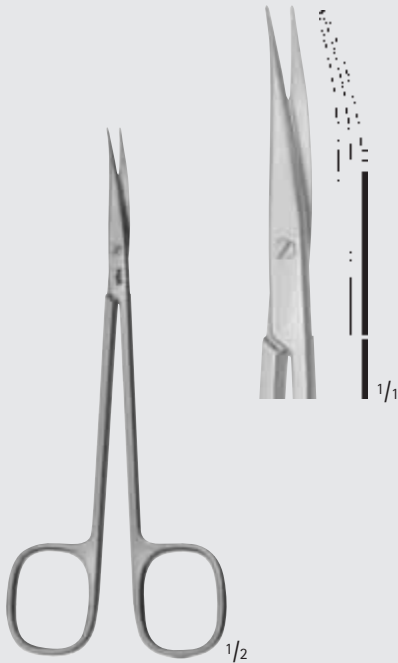

REYNOLDS-JAMESON

BC015R

Gefäß-Schere
Vascular scissors
140 mm, 5 1/2"



Außenkanten der Blätter halbscharf
blades outside semi-sharp

BC017R

Nerv-Präparierschere
Nerve dissecting scissors
140 mm, 5 1/2"

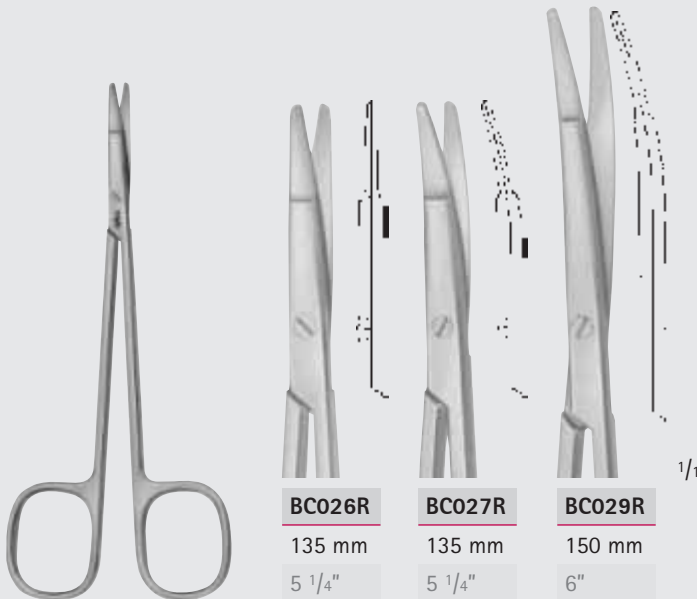

RAGNELL

BC026R-BC029R

Besonders flache Spitzen zum Präparieren
und Unterminieren der Haut
Special flat points for dissecting and
undermining the skin

BC026R

135 mm
5 1/4"

BC027R

135 mm
5 1/4"

BC029R

150 mm
6"

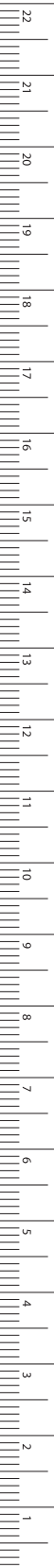

Scheren – Scissors

Feine Scheren

Delicate Scissors

BC

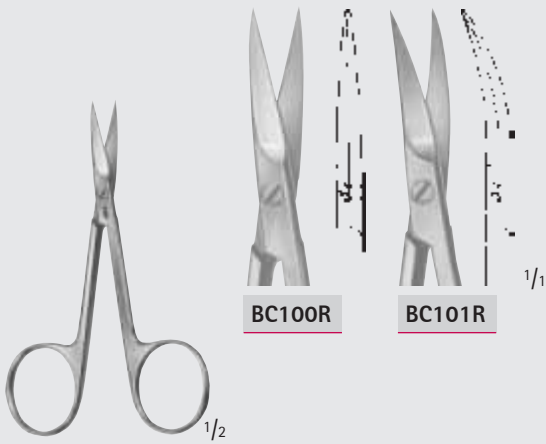

BC100R-BC101R
90 mm, 3 1/2"



BC056R-BC057R
90 mm, 3 3/4"

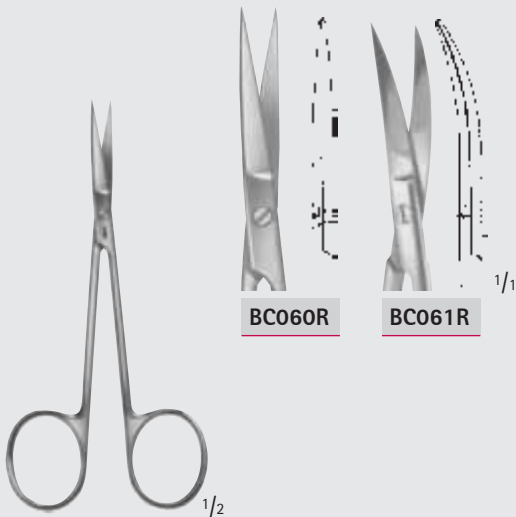

BC060R-BC061R
105 mm, 4 1/8"



BC064R-BC065R
120 mm, 4 3/4"





Scheren – Scissors
 Feine Scheren
 Delicate Scissors

BC



BC110R-BC117R
 110 mm, 4 3/8"

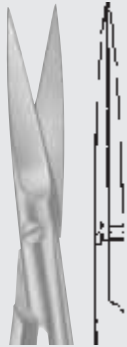

BC110R

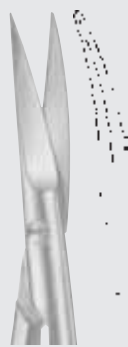

BC111R

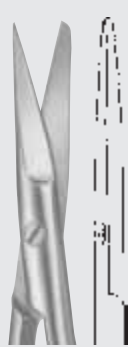

BC112R



BC113R



BC117R

seitwärts gebogen
 curved to side

1/1



BC106R-BC107R
 115 mm, 4 1/2"



BC106R

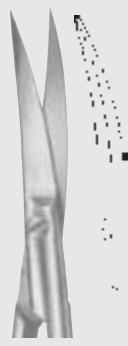

BC107R

1/1



DO210R-DO211R
 120 mm, 4 3/4"



DO210R



DO211R

1/1



MILLIMETERS

Scheren – Scissors

Feine Scheren

Delicate Scissors

BC



BC130R-BC135R
120 mm, 4 3/4"

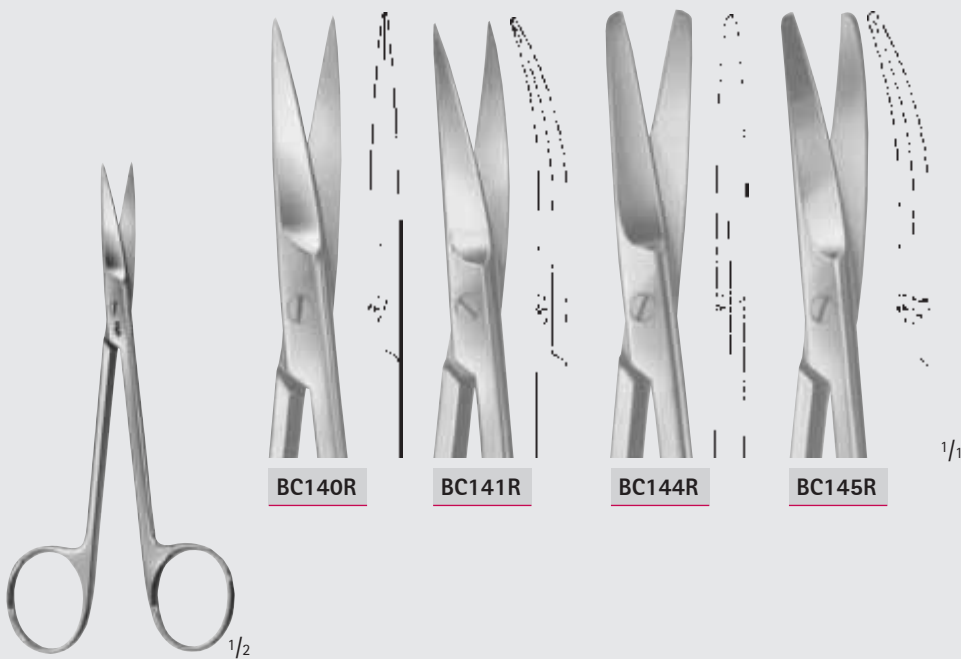

BC140R-BC145R
130 mm, 5 1/8"



Scheren – Scissors
Feine Scheren
Delicate Scissors

BC

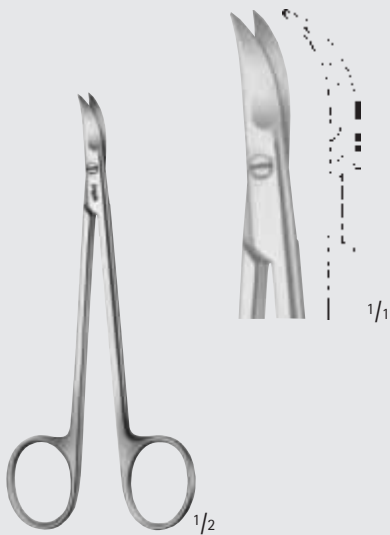

CHADWICK

BC153R

115 mm, 4 1/2"

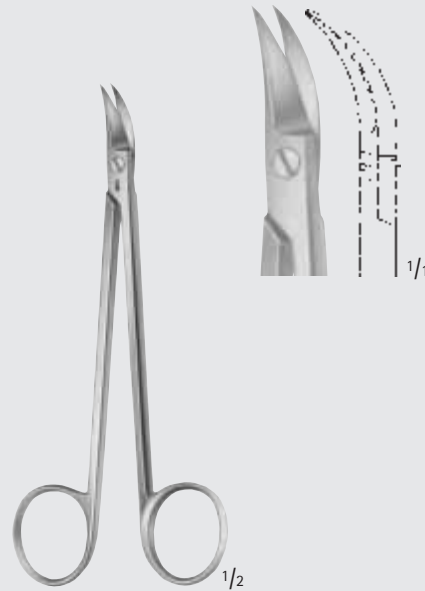

QUINBY

DO218R

130 mm, 5 1/8"

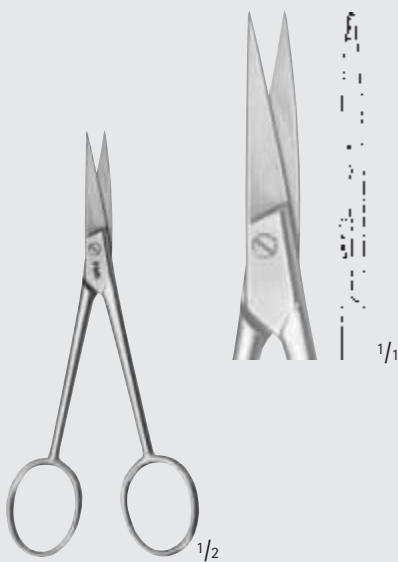

BC050R

110 mm, 4 3/8"

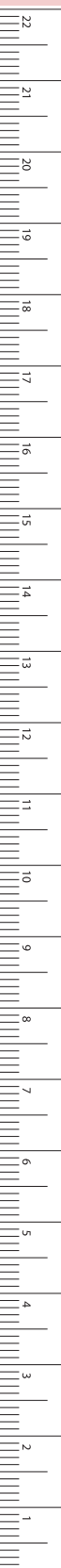

MILLIMETERS

Scheren – Scissors

Feine Scheren

Delicate Scissors

BC



PERWITZSCHKY

OM489R

Speichelgangschere

Salival scissors

100 mm, 4 1/2"



BC033R

115 mm, 4 1/2"

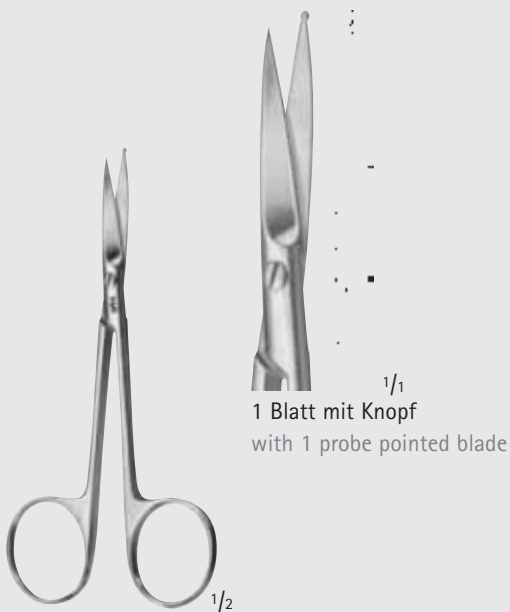

BC030R

120 mm, 4 3/4"

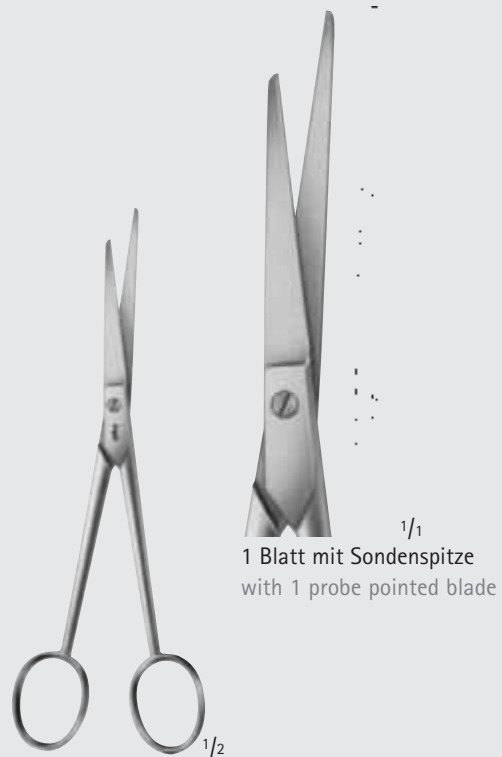

BC034R

145 mm, 5 3/4"



Scheren – Scissors
 Feine Scheren
 Delicate Scissors

BC

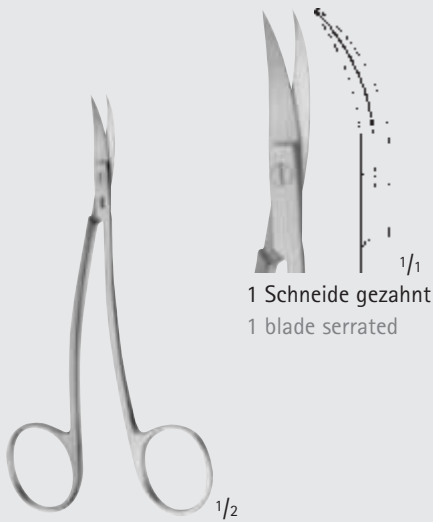

1 Schneide gezahnt
 1 blade serrated

LA GRANGE

BC154R

110 mm, 4 3/8"



abgewinkelt,
 1 Schneide gezahnt
 angled on flat,
 1 blade serrated

DO252R

125 mm, 5"

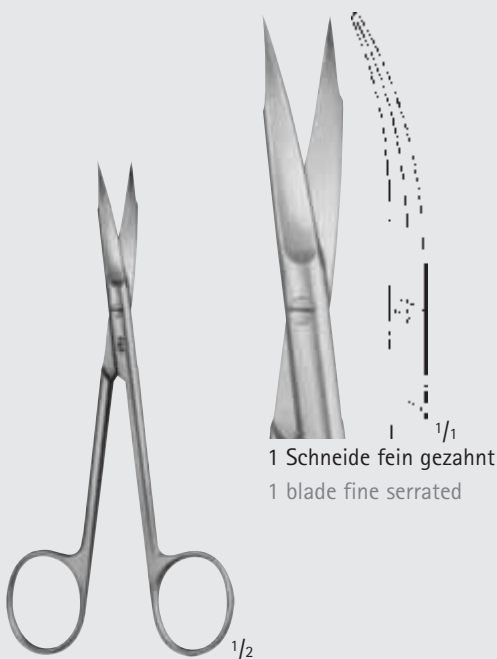

1 Schneide fein gezahnt
 1 blade fine serrated

DO251R

130 mm, 5 1/8"

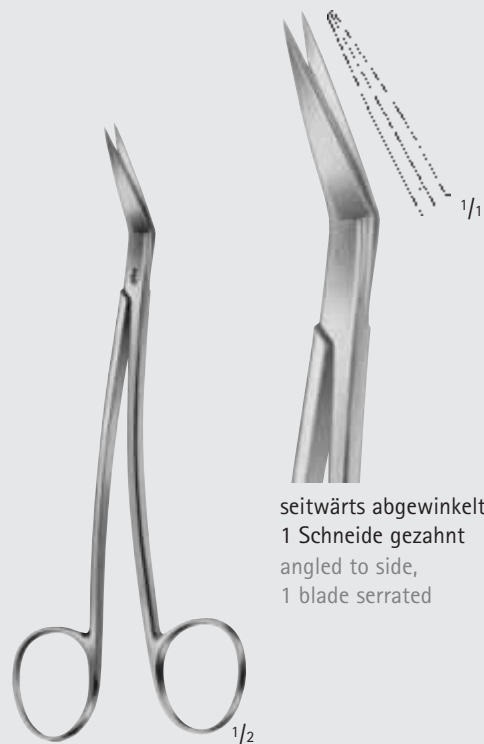

seitwärts abgewinkelt,
 1 Schneide gezahnt
 angled to side,
 1 blade serrated

LOCKLIN

DO219R

155 mm, 6"



MILLIMETERS

Scheren – Scissors

Feine Scheren

Delicate Scissors

BC



JOSEPH

BC156R-BC157R

150 mm, 6"



BC156R

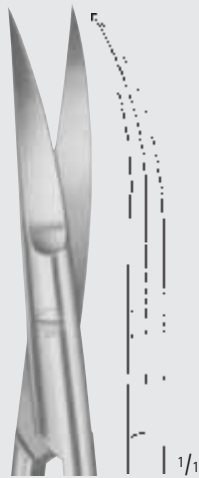

BC157R

1/1



KELLY

BC160R-BC161R

175 mm, 7"

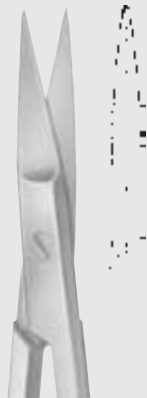

BC160R



BC161R

1/1



Scheren – Scissors
 Chirurgische Scheren
 Surgical Scissors

BC



BC320R-BC330R
 Standard-Modelle
 Standard patterns

BC320R	BC321R	BC323R	BC324R	BC325R	BC326R	BC327R	BC328R	BC330R
105 mm	115 mm	130 mm	145 mm	150 mm	165 mm	175 mm	185 mm	200 mm
4 1/8"	4 1/2"	5 1/8"	5 3/4"	6"	6 1/2"	7"	7 1/4"	8"

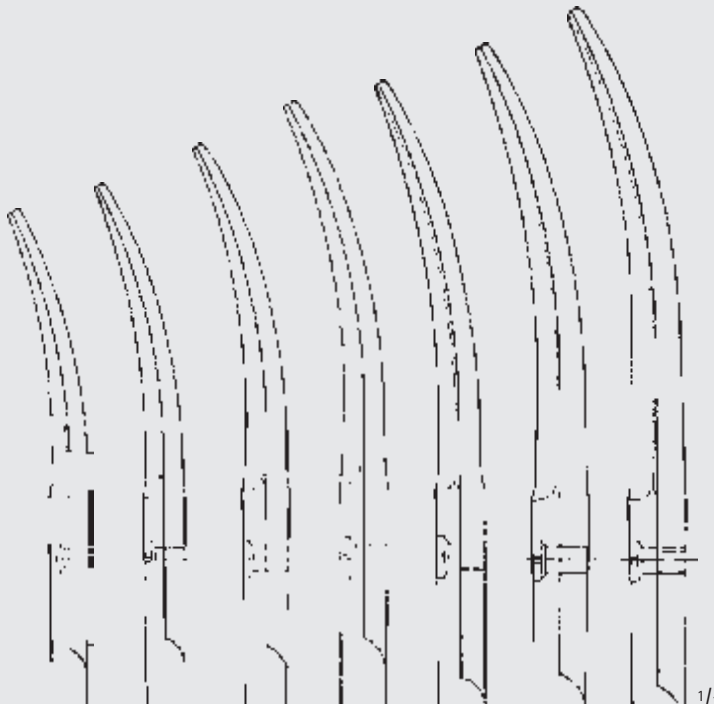

BC421R-BC428R
 Standard-Modelle
 Standard patterns

BC421R	BC423R	BC424R	BC425R	BC426R	BC427R	BC428R
115 mm	130 mm	145 mm	150 mm	165 mm	175 mm	185 mm
4 1/2"	5 1/8"	5 3/4"	6"	6 1/2"	7"	7 1/4"



MILLIMETERS

Scheren – Scissors
 Chirurgische Scheren
 Surgical Scissors

BC

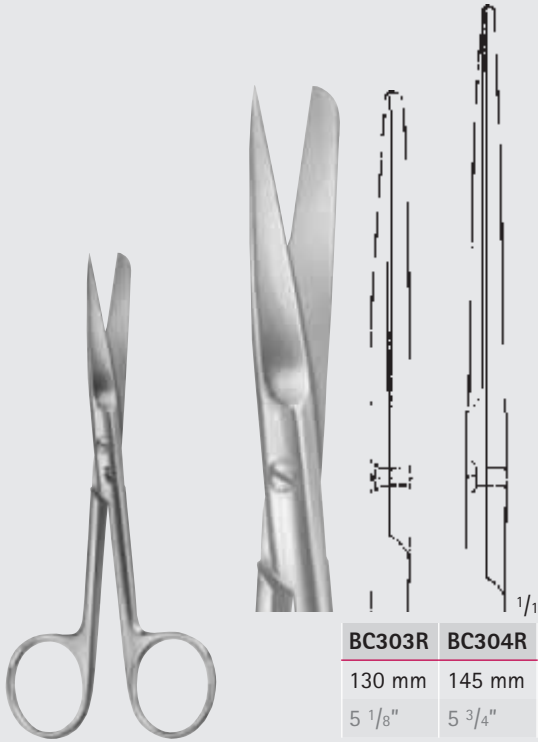

BC303R	BC304R
130 mm	145 mm
5 1/8"	5 3/4"

BC303R-BC304R
 schlanke Modelle
 slender patterns

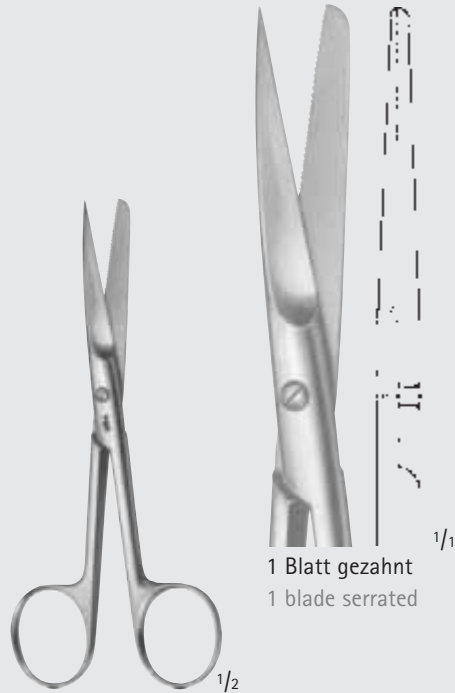

1 Blatt gezahnt
 1 blade serrated

BC496R
 Wundrandschere
 Scissors for wound edges
 130 mm, 5 1/8"

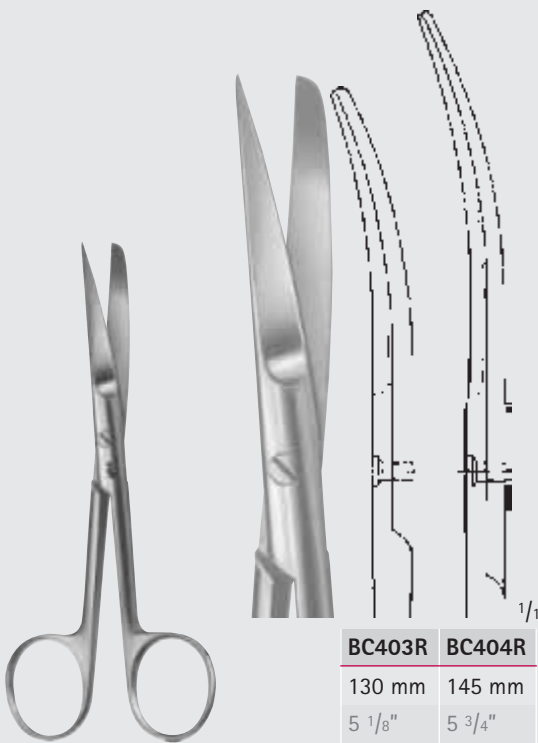

BC403R	BC404R
130 mm	145 mm
5 1/8"	5 3/4"

BC403R-BC404R
 schlanke Modelle
 slender patterns



1 Blatt gezahnt
 1 blade serrated

BC497R
 Wundrandschere
 Scissors for wound edges
 130 mm, 5 1/8"



Scheren – Scissors
Chirurgische Scheren
Surgical Scissors

BC

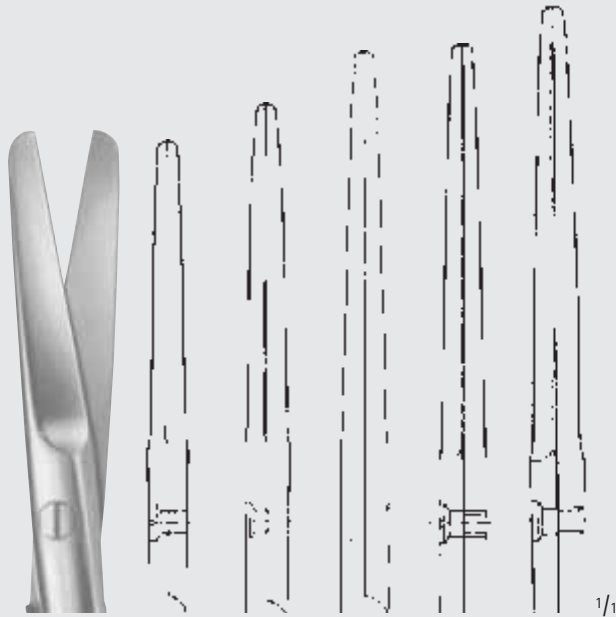

BC313R	BC314R	BC315R	BC316R	BC317R
130 mm	145 mm	150 mm	165 mm	175 mm
5 1/8"	5 3/4"	6"	6 1/2"	7"

BC313R-BC317R

Standard-Modelle
Standard patterns

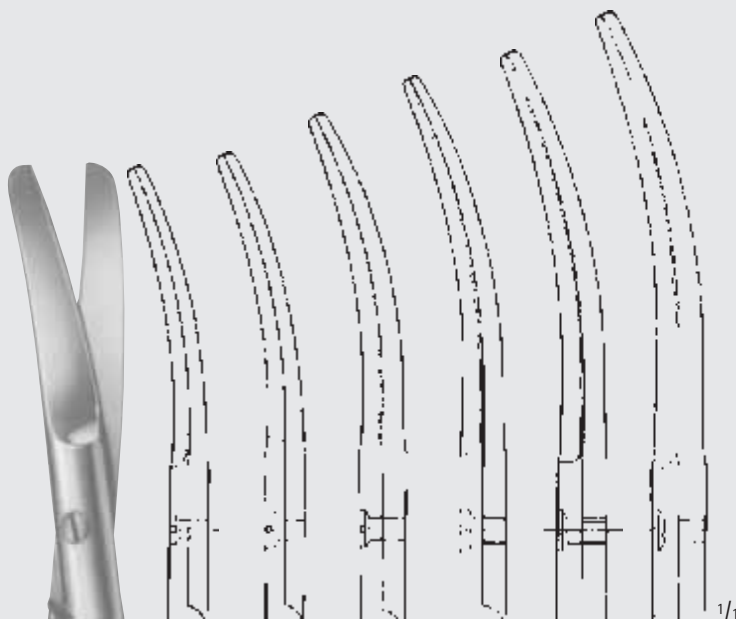

BC411R	BC413R	BC414R	BC415R	BC416R	BC417R
115 mm	130 mm	145 mm	150 mm	165 mm	175 mm
4 1/2"	5 1/8"	5 3/4"	6"	6 1/2"	7"

COOPER

BC411R-BC417R

Standard-Modelle
Standard patterns

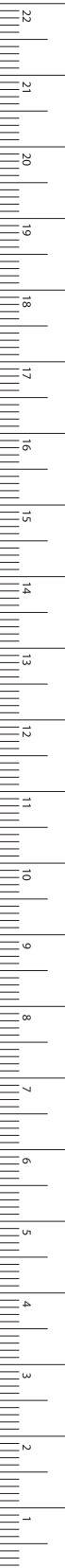

MILLIMETERS

Scheren – Scissors
 Chirurgische Scheren
 Surgical Scissors

BC

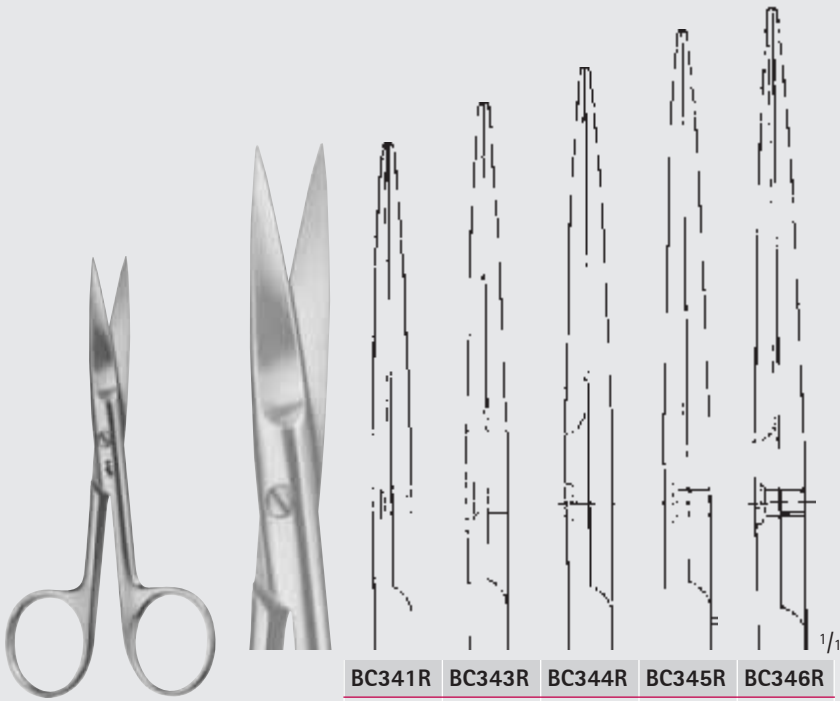

BC341R-BC346R
 Standard-Modelle
 Standard patterns

BC341R	BC343R	BC344R	BC345R	BC346R
115 mm	130 mm	145 mm	150 mm	165 mm
4 1/2"	5 1/8"	5 3/4"	6"	6 1/2"

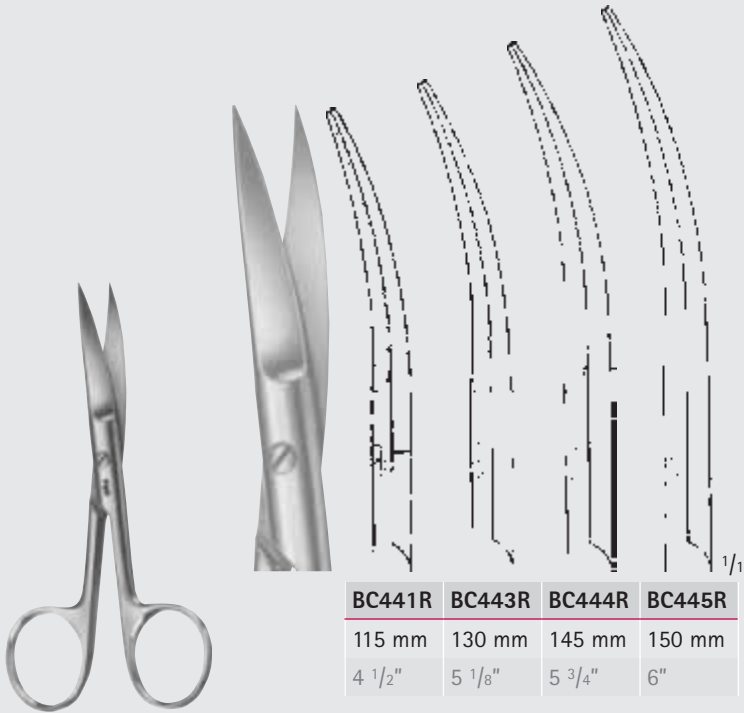

BC441R-BC445R
 Standard-Modelle
 Standard patterns

BC441R	BC443R	BC444R	BC445R
115 mm	130 mm	145 mm	150 mm
4 1/2"	5 1/8"	5 3/4"	6"



Scheren – Scissors
 Chirurgische Scheren
 Surgical Scissors

BC

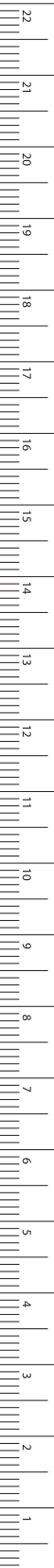

BC374R

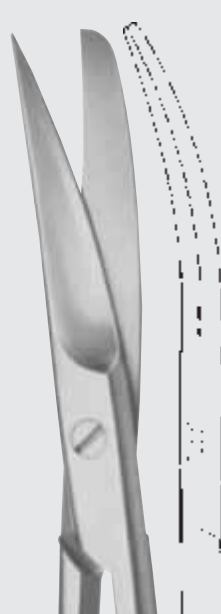

BC474R

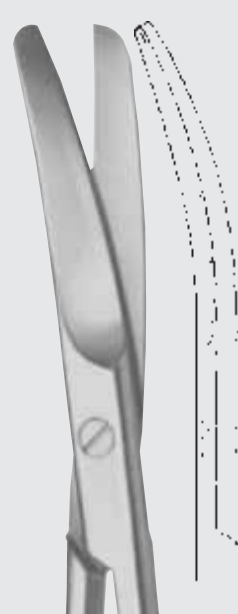

BC464R

1/1

DEAVER

BC374R-BC474R

Chirurgische Scheren mit Flachschluss

Surgical scissors with flat lock

145 mm, 5 3/4"



1/1

BC503R	BC504R	BC506R
130 mm	145 mm	165 mm
5 1/8"	5 3/4"	6 1/2"

BC503R-BC506R

Inzisions-Scheren

Incision scissors



1/1

SYSTRUNK

BC521R

Nagelspaltschere

Nail splitting scissors

130 mm, 5 1/8"

MILLIMETERS

Scheren – Scissors

Präparierscheren, feine Modelle

Dissecting Scissors, Delicate Patterns

BC

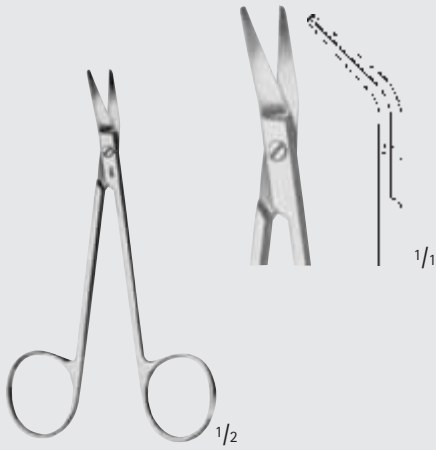

GRAEFE

OC415R

Präparierschere

Dissecting scissors

100 mm, 4"

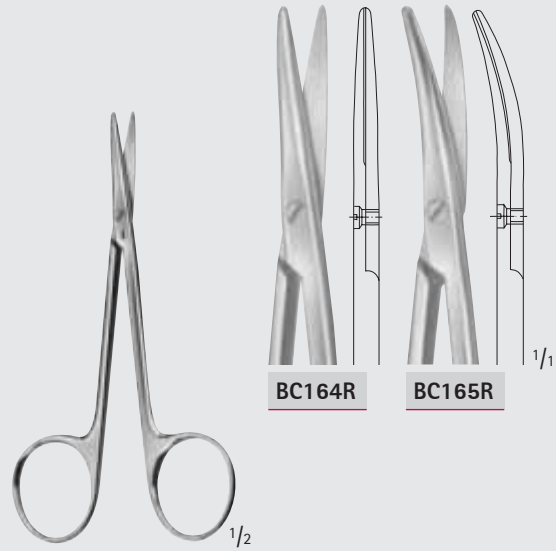

BC164R

BC165R

BC164R-BC165R

Präparierscheren

Dissecting Scissors

115 mm, 4 1/2"

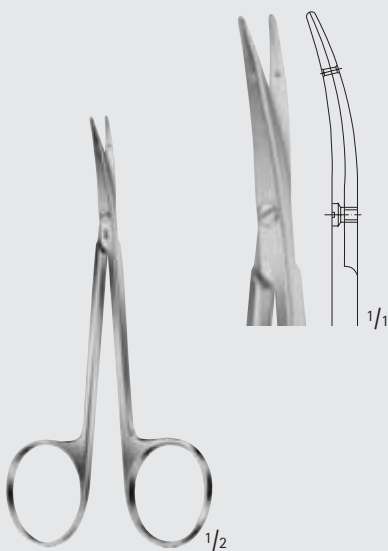

LITTLER

BC163R

Präparierschere
mit Fadenbohrung in der Spitze

Dissecting scissors,
tips with eye for suture

115 mm, 4 1/2"



COTTLE

OK374R

Bulldog-Schere

Bulldog scissors

115 mm, 4 1/2"

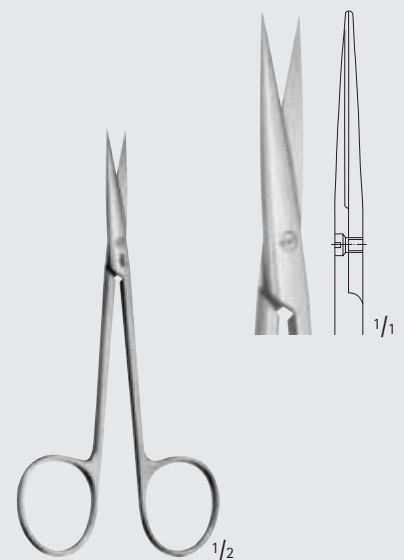

KILNER

BC162R

feine Präparierschere

delicate dissecting scissors

115 mm, 4 1/2"



Scheren – Scissors
 Präparierscheren, feine Modelle
 Dissecting Scissors, Delicate Patterns

BC

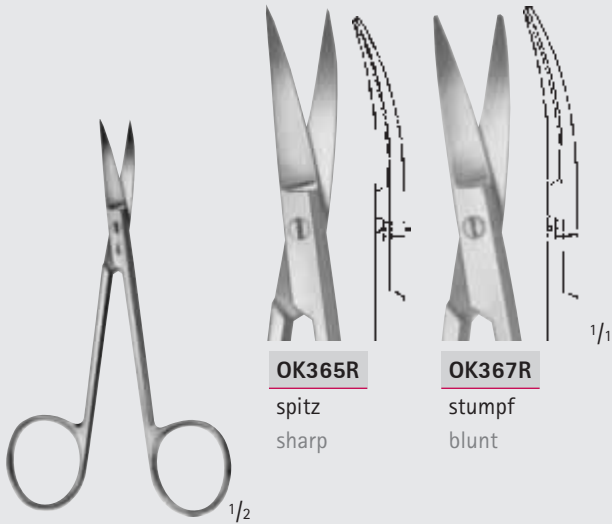

OK365R
 spitz
 sharp

OK367R
 stumpf
 blunt

COTTLE-MASING

OK365R-OK367R

Scheren für die plastische Chirurgie
 Scissors for plastic surgery
 105 mm, 4 1/8"

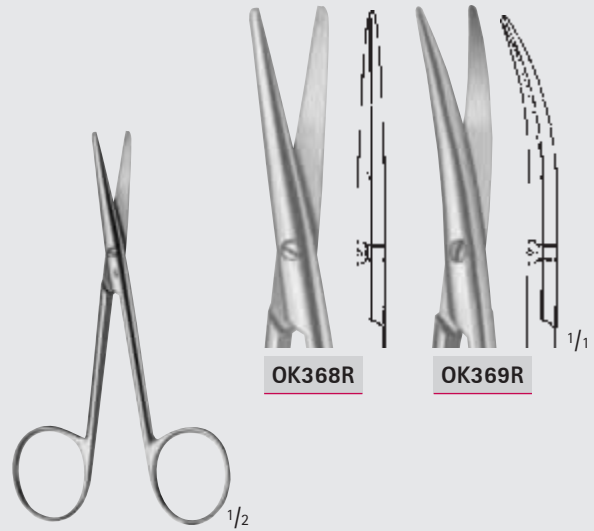

OK368R

OK369R

COTTLE-KNAPP

OK368R-OK369R

Scheren für die plastische Chirurgie
 Scissors for plastic surgery
 105 mm, 4 1/8"



OK372R
 135 mm
 5 1/4"

OK373R
 115 mm
 4 1/2"

FOMON

OK372R-OK373R

Nasenflügelscheren
 Lower lateral scissors

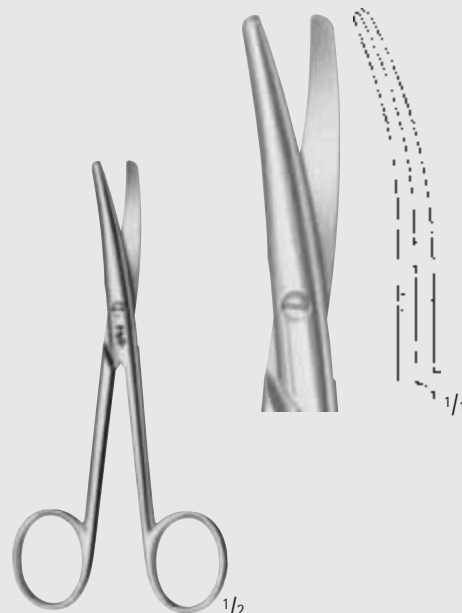

LANDOLT

OC430R

Enukleationsschere
 Enucleation scissors
 120 mm, 4 3/4"

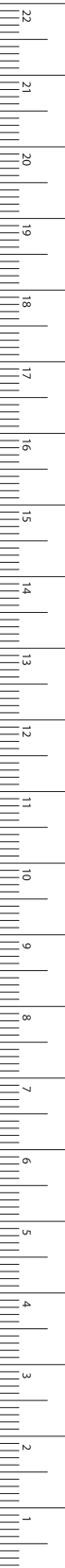

MILLIMETERS

Scheren – Scissors

Präparierscheren, feine Modelle

Dissecting Scissors, Delicate Patterns

BC

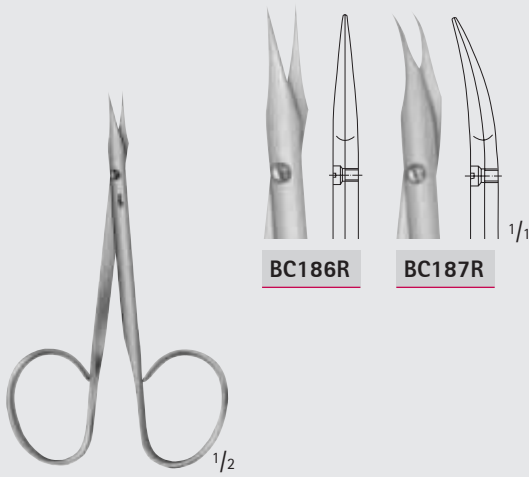

STEVENS

BC186R-BC187R

Gefäß- und Sehnscheren
Vascular- and tendon scissors
100 mm, 4"

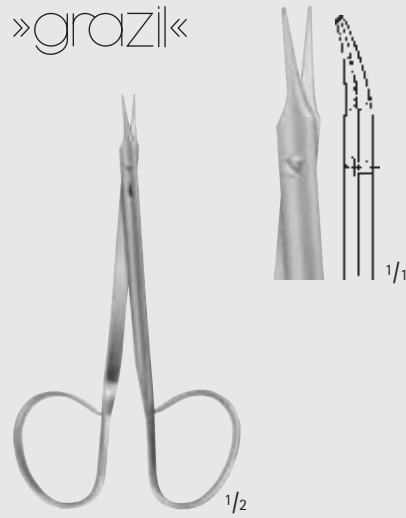

STEVENS

OK366R

feine Präparierschere
delicate dissecting scissors
110 mm, 4 3/8"

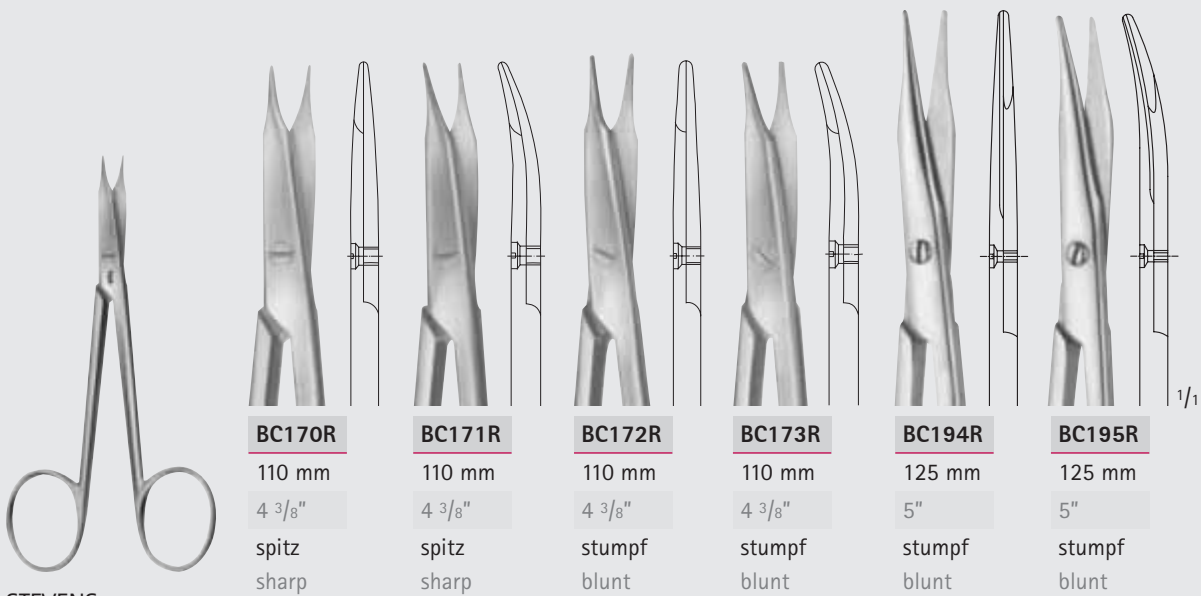

STEVENS

BC170R-BC195R

Gefäß- und Sehnscheren
Vascular- and tendon scissors

BC170R

110 mm
4 3/8"
spitz
sharp

BC171R

110 mm
4 3/8"
spitz
sharp

BC172R

110 mm
4 3/8"
stumpf
blunt

BC173R

110 mm
4 3/8"
stumpf
blunt

BC194R

125 mm
5"
stumpf
blunt

BC195R

125 mm
5"
stumpf
blunt



Scheren – Scissors

Präparierscheren, feine Modelle
Dissecting Scissors, Delicate Patterns

BC

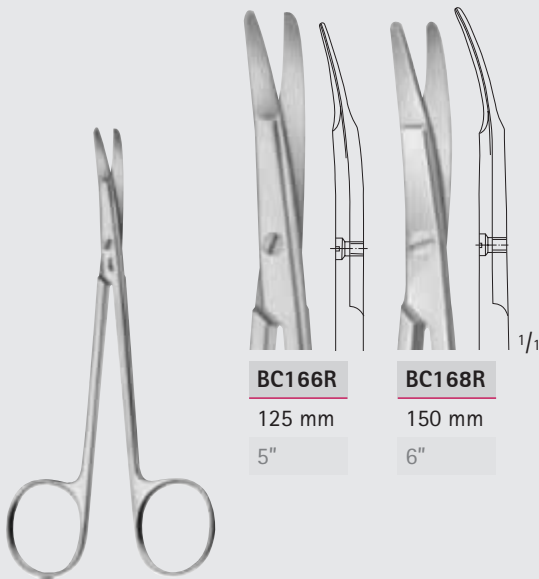

BC166R

125 mm

5"

BC168R

150 mm

6"

KILNER

BC166R-BC168R

besonders flache Spitzen zum Präparieren
und Unterminieren der Haut
special flat points for dissecting and
undermining the skin

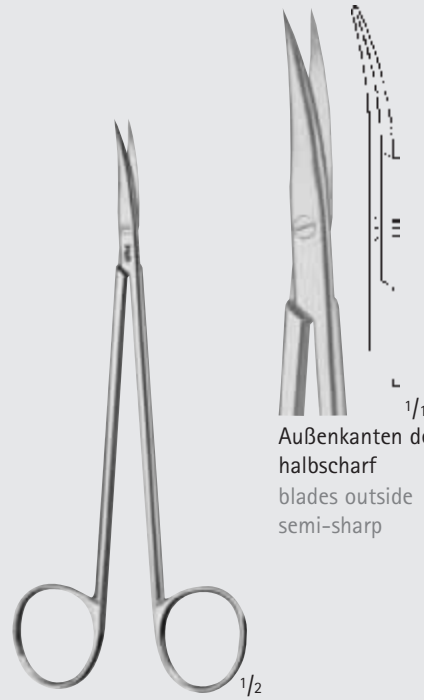

Außenkanten der Blätter
halbscharf
blades outside
semi-sharp

BC628R

Nerv-Präparierschere
Nerve dissecting scissors
150 mm, 6"

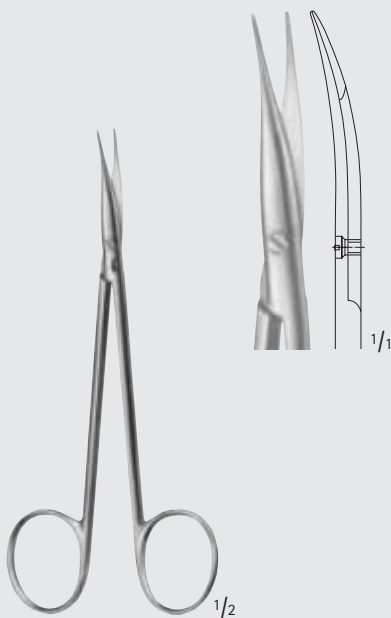

JAMESON-WERBER

BC175R

Präparierschere
Dissecting scissors
130 mm, 5 1/8"

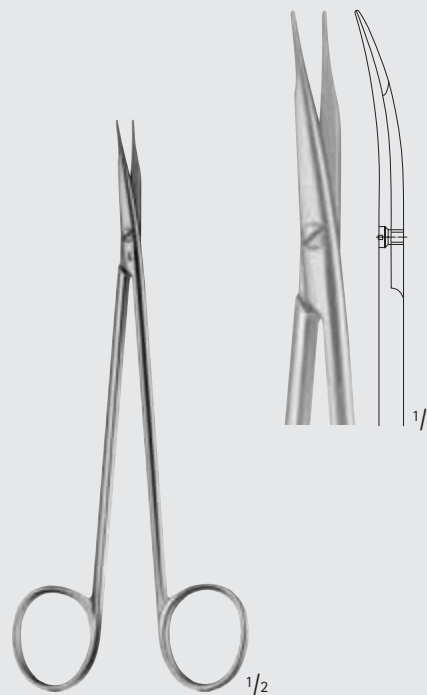

JAMESON

BC177R

Präparierschere
Dissecting scissors
150 mm, 6"



MILLIMETERS

Scheren – Scissors

Präparierscheren, feine Modelle

Dissecting Scissors, Delicate Patterns

BC



BC180R	BC181R
145 mm	175 mm
5 3/4"	7"

REYNOLDS

BC180R-BC181R

Präparierscheren
Dissecting scissors



POTTS

BC178R

Präparierschere
Dissecting scissors
180 mm, 7"

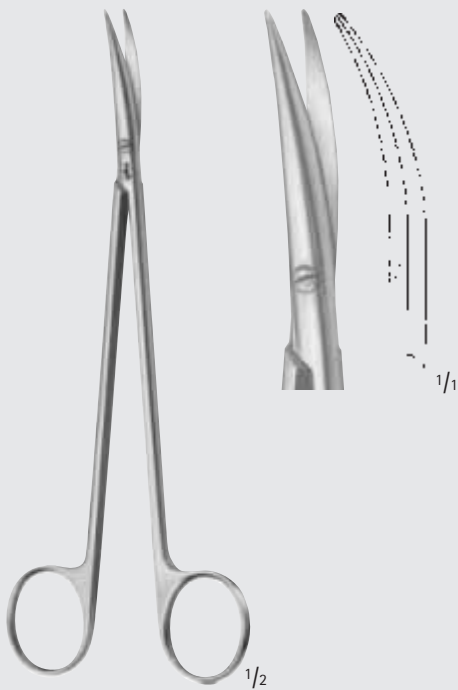

DE BAKEY

BC629R

Arteriotomie-Schere
Arteriotomy scissors
175 mm, 7"

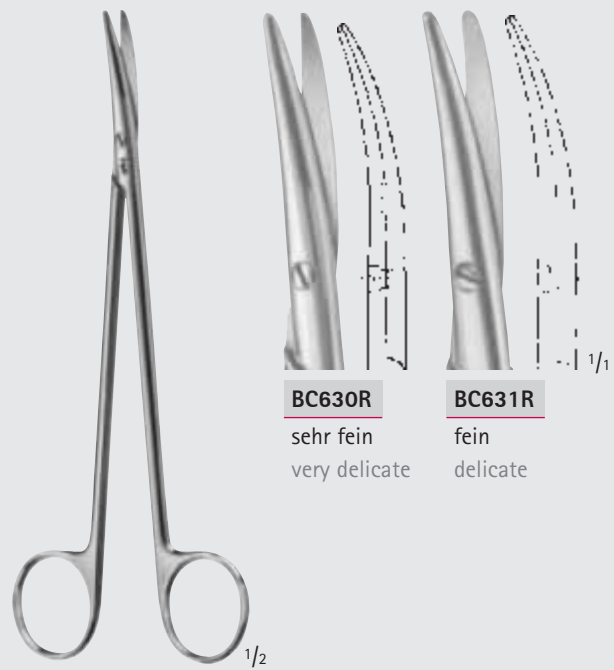

BC630R

sehr fein
very delicate

BC631R

fein
delicate

TÖNNIS-ADSON

BC630R-BC631R

Präparierscheren
Dissecting scissors
175 mm, 7"



Scheren – Scissors
 Präparierscheren, feine Modelle
 Dissecting Scissors, Delicate Patterns

BC

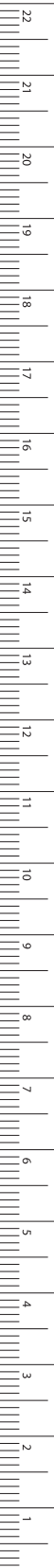

1/2



BC633R

sehr fein
very delicate



BC634R

fein
delicate



BC635R

fein
delicate

1/1

TÖNNIS

BC633R-BC635R

Präparierscheren
Dissecting scissors
180 mm, 7"

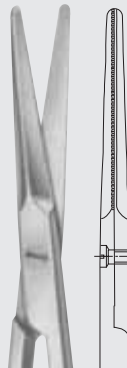

BC184R

125 mm
5"

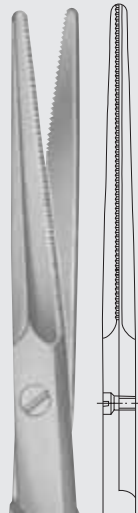

BC188R

195 mm
7 3/4"

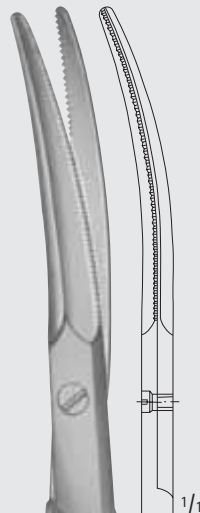

BC189R

195 mm
7 3/4"

1/1

GORNEY

BC184R-BC189R

Präparierscheren für plastische Chirurgie
 Schneiden: außen halbscharf
 innen fein gezahnt
 Dissection scissors for plastic surgery
 Blades: outside semi-sharp
 inside fine serrated



1/2

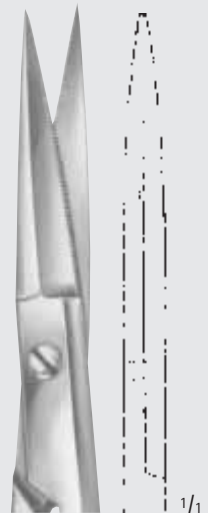

1/1

BC672R

Knorpelschere,
Blätter außen und innen schneidend
Cartilage scissors,
blades cutting on both sides
185 mm, 7 1/4"

MILLIMETERS

Scheren – Scissors

Chirurgische und Präparierscheren
Surgical and Dissecting Scissors

BC



MAYO

BC544R-BC557R

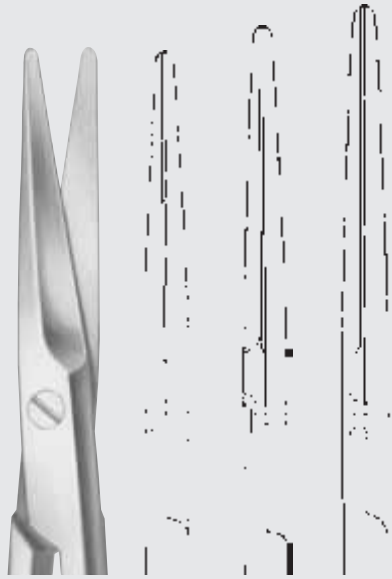

BC544R	BC545R	BC547R
140 mm	155 mm	170 mm
5 1/2"	6"	6 3/4"



BC554R	BC555R	BC557R
140 mm	155 mm	170 mm
5 1/2"	6"	6 3/4"



MAYO-STILLE

BC570R-BC575R

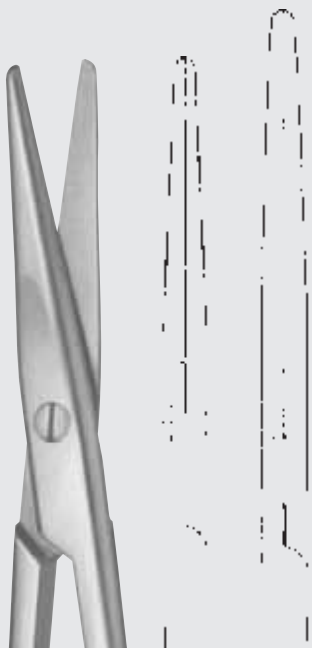

BC570R	BC572R
140 mm	170 mm
5 1/2"	6 3/4"



BC573R	BC575R
140 mm	170 mm
5 1/2"	6 3/4"



Scheren – Scissors
 Präparierscheren
 Dissecting Scissors

BC

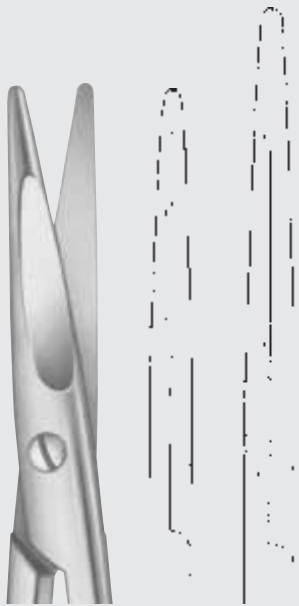
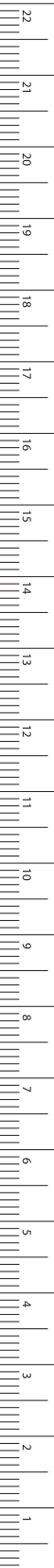

BC576R	BC578R
140 mm	170 mm
5 1/2"	6 3/4"

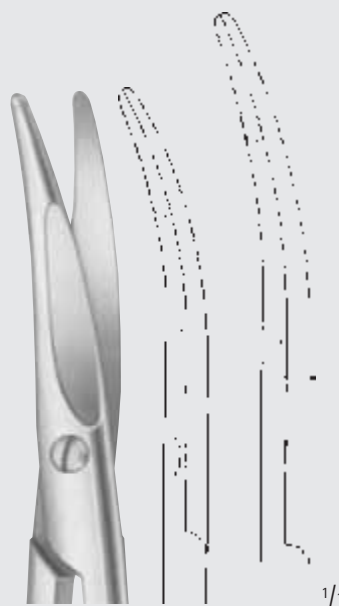

BC577R	BC579R
140 mm	170 mm
5 1/2"	6 3/4"

MAYO-STILLE

BC576R-BC579R

mit abgeschrägten Schneiden
 with chamfered blades

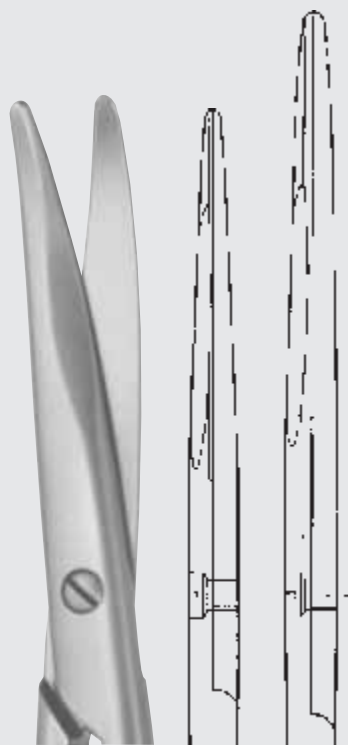

BC562R	BC564R
190 mm	215 mm
7 1/2"	8 1/2"



BC563R	BC565R
190 mm	215 mm
7 1/2"	8 1/2"

MAYO

BC562R-BC565R

mit abgeschrägten Schneiden
 with chamfered blades

MILLIMETERS

Scheren – Scissors
 Präparierscheren
 Dissecting Scissors

BC

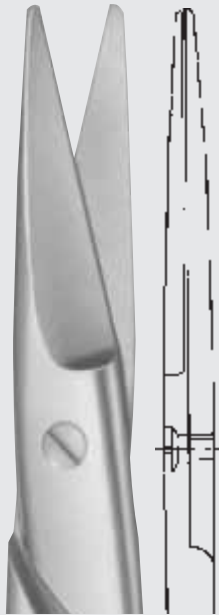

BC566R

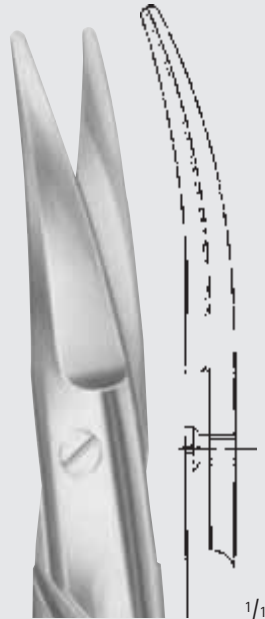

BC569R

MAYO-NOBLE

BC566R-BC569R

breite Modelle
 broad patterns
 170 mm, 6 3/4"

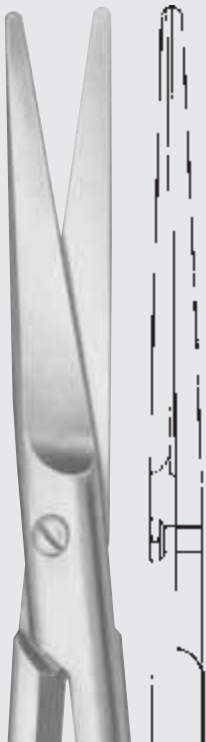

BC560R



BC561R

MAYO-HARRINGTON

BC560R-BC561R

230 mm, 9"



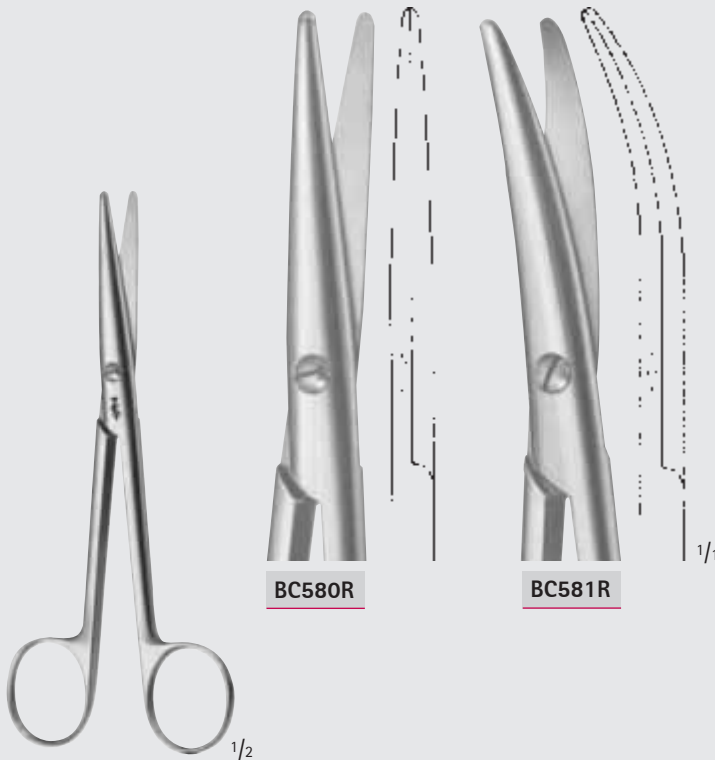
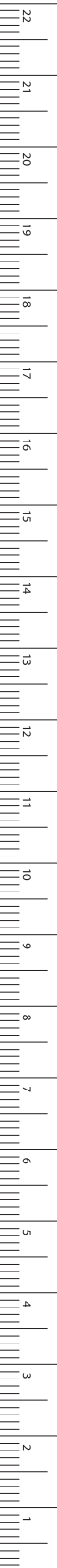

BC580R

BC581R

STILLE

BC580R-BC581R

150 mm, 6"



BC590R

BC591R

LEXER

BC590R-BC591R

schmal
 narrow
 165 mm, 6 1/2"

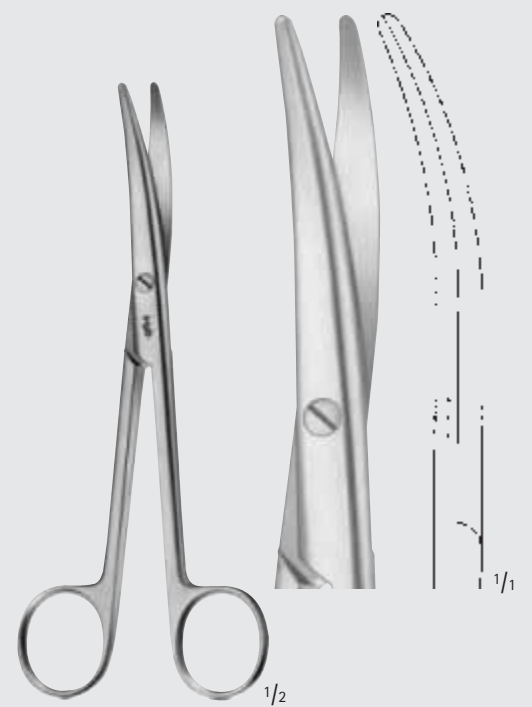

MAYO-LEXER

BC592R

Standard-Modell
 Standard pattern
 165 mm, 6 1/2"

Scheren – Scissors
 Präparierscheren
 Dissecting Scissors

BC



BC584R	BC585R
165 mm	200 mm
6 1/2"	8"



BC587R	BC588R	BC589R
165 mm	200 mm	210 mm
6 1/2"	8"	8 1/4"



MAYO

BC584R-BC589R



Scheren – Scissors
 Präparierscheren
 Dissecting Scissors

BC

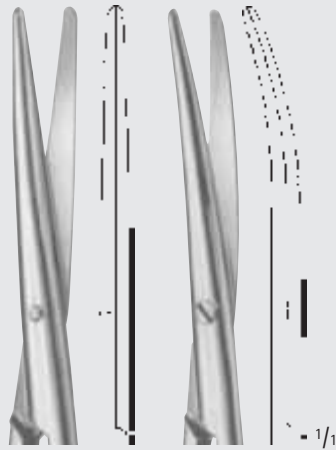

BC600R

BC603R

BABY-METZENBAUM

BC600R-BC603R

145 mm, 5 3/4"

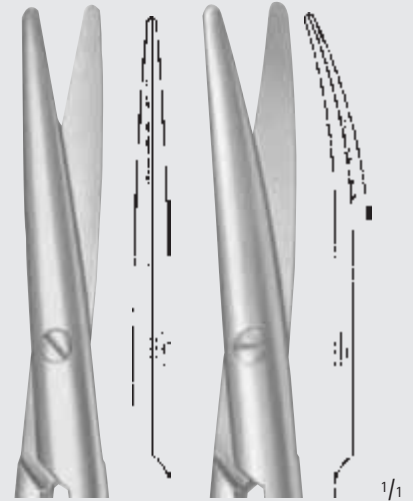

BC680R

200 mm

8"

BC683R

160 mm

6 1/4"

METZENBAUM

BC680R-BC683R

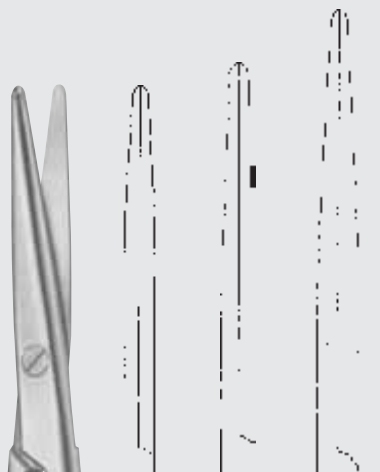

BC601R

145 mm

5 3/4"

BC602R

180 mm

7"

BC604R

200 mm

8"

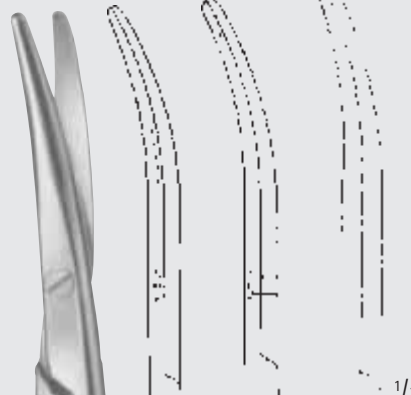

BC605R

145 mm

5 3/4"

BC606R

180 mm

7"

BC607R

200 mm

8"

METZENBAUM

BC601R-BC607R



MILLIMETERS

Scheren – Scissors
 Präparierscheren
 Dissecting Scissors

BC

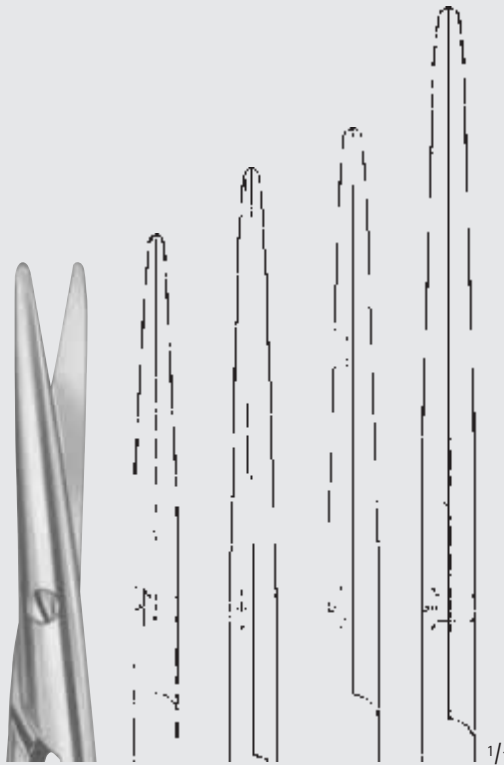

BC611R	BC612R	BC613R	BC614R
230 mm	250 mm	280 mm	305 mm
9"	10"	11"	12"



NELSON-METZENBAUM

BC611R-BC625R

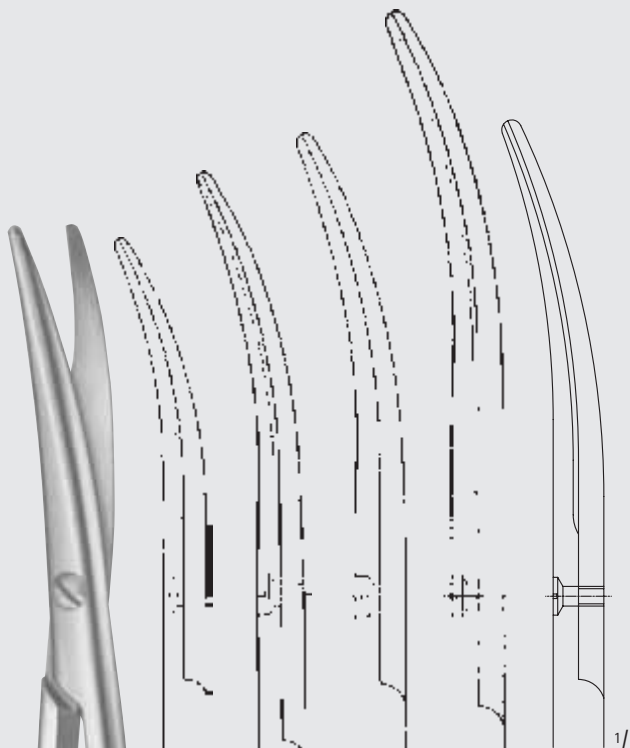

BC615R	BC616R	BC618R	BC619R	BC625R
230 mm	250 mm	280 mm	305 mm	350 mm
9"	10"	11"	12"	14"

Scheren – Scissors

Präparierscheren, Kapselscheren
Dissecting Scissors, Cartilage Scissors

BC

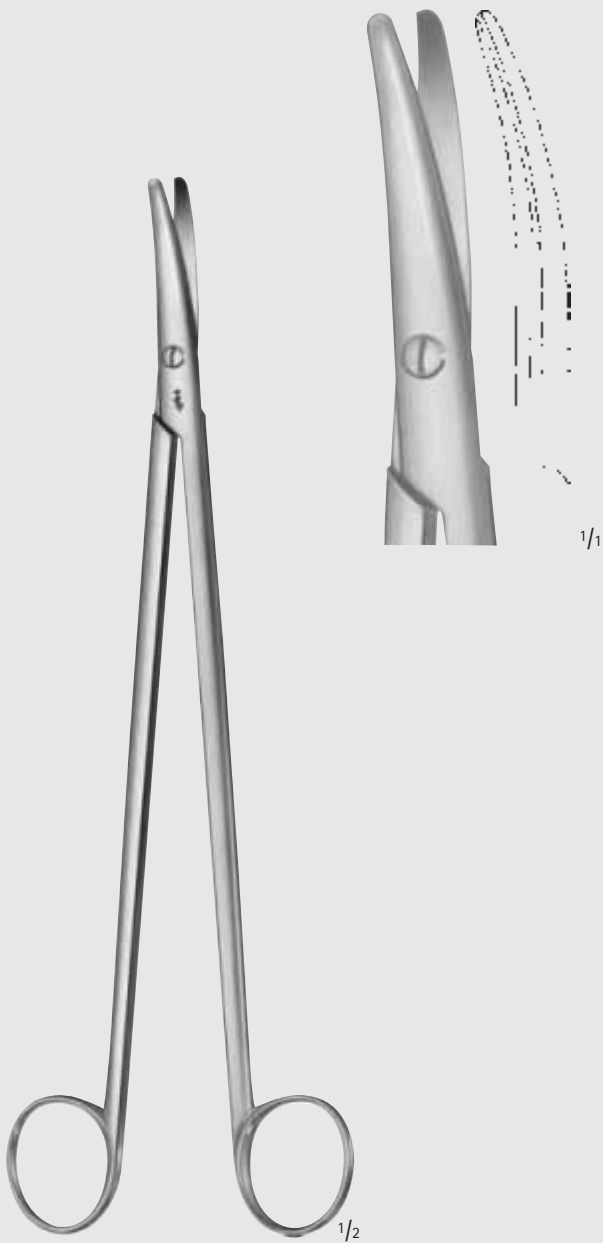

WELLER

BC620R

Präparierschere, kräftiges Modell
Dissecting scissors, heavy pattern
280 mm, 11"



RESANO

BC595R

Kapselschere
Cartilage scissors
250 mm, 10"

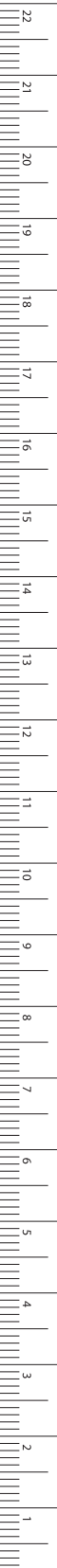

Scheren – Scissors
 SuperCut Scheren
 SuperCut Scissors

BC

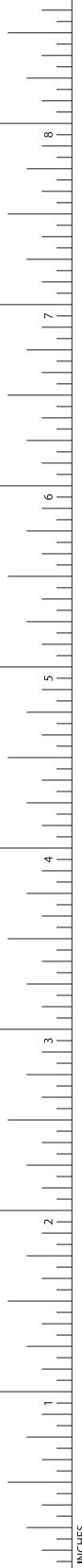

BC900R	BC901R
spitz sharp	spitz sharp

BC900R-BC901R
 110 mm, 4 3/8"

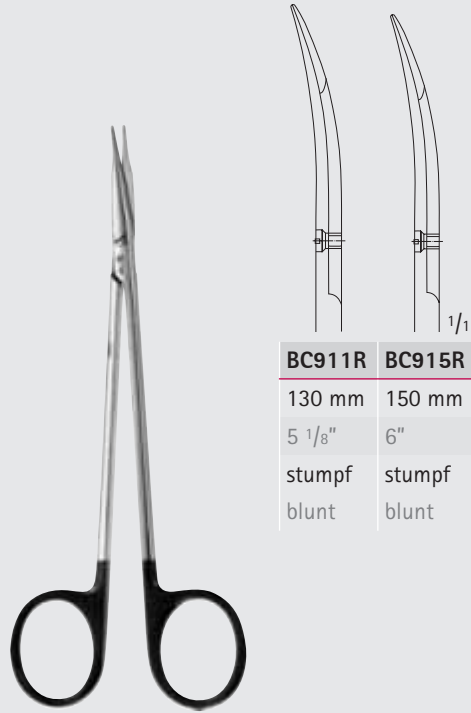

BC911R	BC915R
130 mm	150 mm
5 1/8"	6"
stumpf blunt	stumpf blunt

JAMESON
BC911R-BC915R



BC916R	BC917R
spitz sharp	spitz sharp

JOSEPH
BC916R-BC917R
 150 mm, 6"

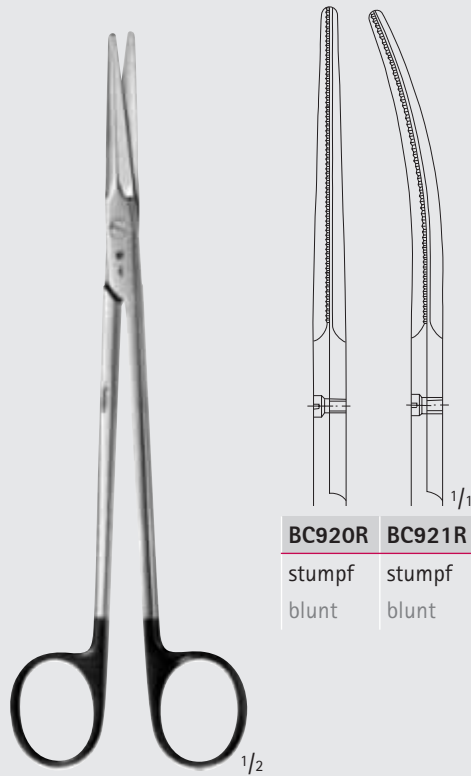

BC920R	BC921R
stumpf blunt	stumpf blunt

GORNEY
BC920R-BC921R
 195 mm, 7 3/4"



Scheren – Scissors
 SuperCut Scheren
 SuperCut Scissors

BC



BC924R BC925R

MAYO

BC924R-BC925R

165 mm, 6 1/2"

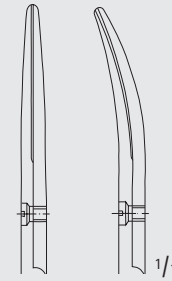

BC930R BC931R

BABY-METZENBAUM

BC930R-BC931R

115 mm, 4 1/2"



BC934R BC937R

145 mm 180 mm

5 3/4" 7"

METZENBAUM

BC934R-BC937R

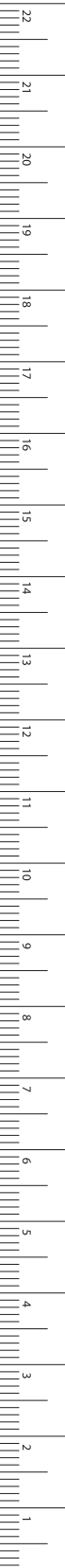

MILLIMETERS

Scheren – Scissors

DUROTIP® Feine Scheren

DUROTIP® Delicate Scissors



DUROTIP®-Scheren
mit eingesetzten Hartmetall-Schneiden

- 3 Jahre Garantie!
- Hervorragende Schnitthaltigkeit
- Lange Lebensdauer
- Vergoldete Ring

DUROTIP® Scissors
with inserted carbide cutting edges

- 3 years guarantee!
- Excellent cutting accuracy
- Long working life
- Gold-plated rings

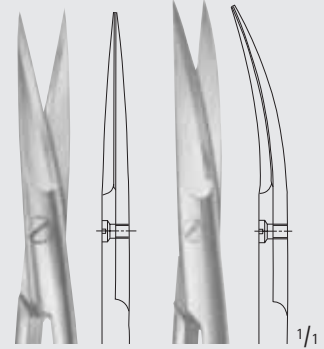

BC210R

BC211R



BC210R-BC211R

Fadenscheren
Ligature scissors
110 mm, 4 3/8"

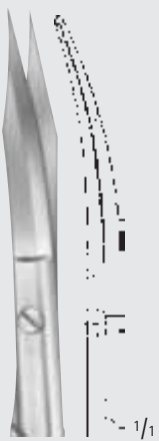

1 Schneide gezahnt
1 blade serrated



GOLDMAN-FOX

DO250R

130 mm, 5 1/8"

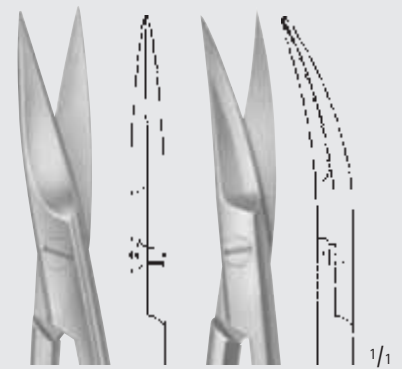

DO208R

DO209R



DO208R-DO209R

120 mm, 4 3/4"

BC



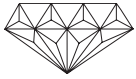

Scheren – Scissors
 DUROTIP® Chirurgische Scheren
 DUROTIP® Surgical Scissors

BC

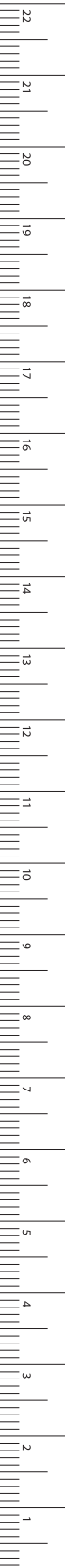

1/2

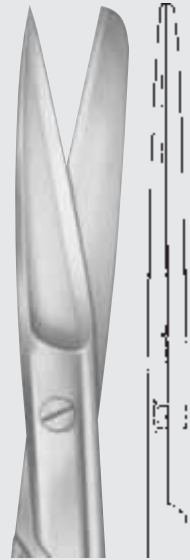

BC224R

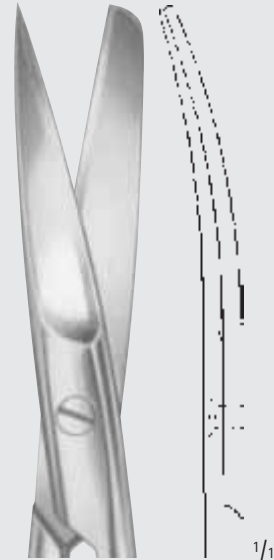

BC234R

1/1

BC224R-BC234R
 145 mm, 5 3/4"

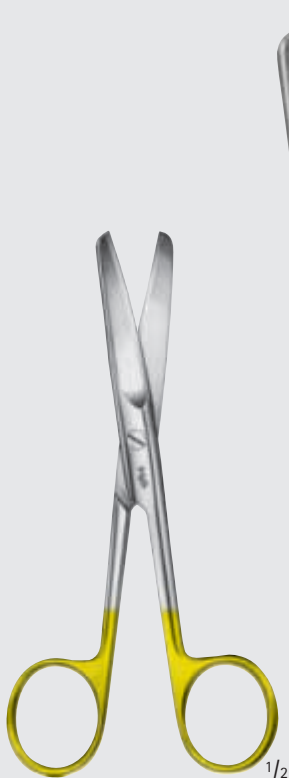

1/2

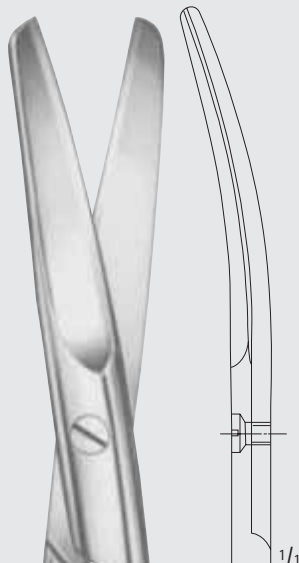

1/1

BC231R
 145 mm, 5 3/4"

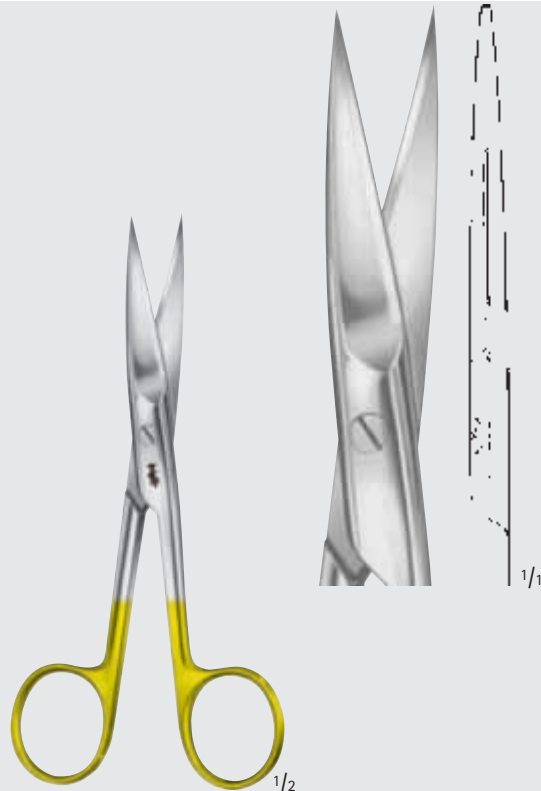

1/2

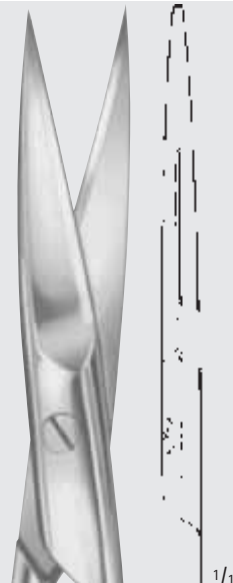

1/1

BC228R
 145 mm, 5 3/4"

MILLIMETERS

Scheren – Scissors

DUROTIP® Präparierscheren

DUROTIP® Dissecting Scissors

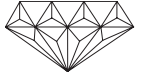

BC



MAYO

BC250R-BC253R



BC250R	BC252R
140 mm	170 mm
5 1/2"	6 3/4"



BC251R	BC253R
140 mm	170 mm
5 1/2"	6 3/4"



MAYO

BC242R-BC559R



BC242R	BC558R
170 mm	230 mm
6 3/4"	9"



BC243R	BC559R
170 mm	230 mm
6 3/4"	9"



LEXER
BC283R
 schmal
 narrow
 165 mm, 6 1/2"

MAYO-LEXER
BC284R
 165 mm, 6 1/2"

BC256R-BC257R
 115 mm, 4 1/2"



MILLIMETERS

Scheren – Scissors
DUROTIP® Präparierscheren
DUROTIP® Dissecting Scissors



BC

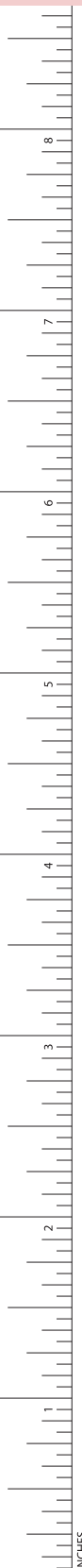

1/2

BABY-METZENBAUM

BC258R-BC259R

145 mm, 5 3/4"

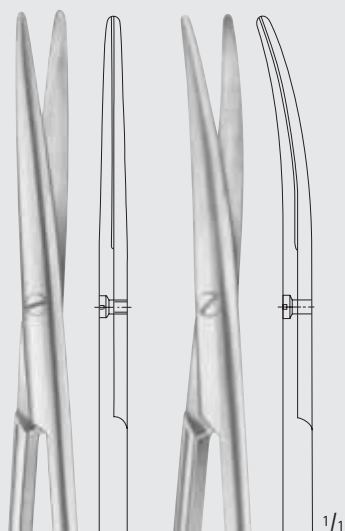

BC258R

BC259R

1/1



1/2

TÖNNIS-ADSON

BC273R

175 mm, 7"

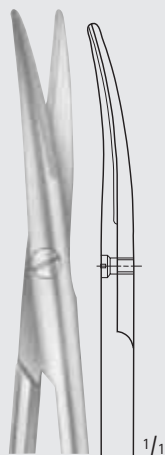

1/1



METZENBAUM

BC270R-BC277R

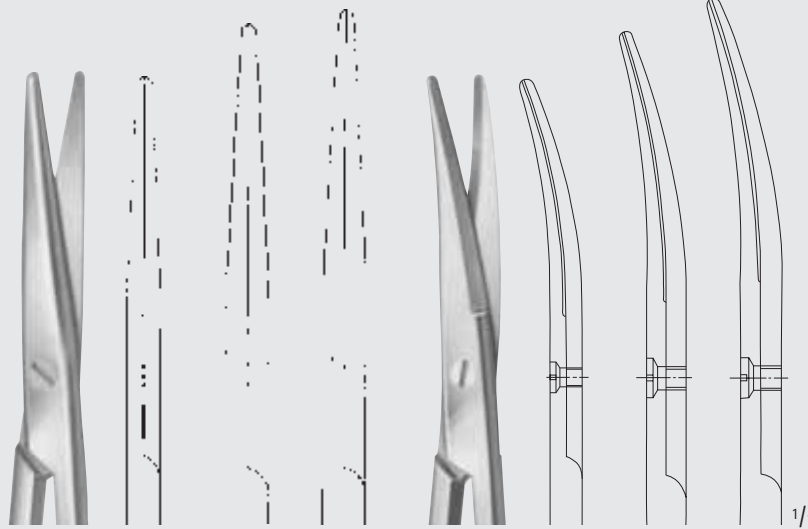

BC270R	BC274R	BC276R
180 mm	200 mm	230 mm
7"	8"	9"

BC271R	BC275R	BC277R
180 mm	200 mm	230 mm
7"	8"	9"



NELSON-METZENBAUM

BC279R-BC285R

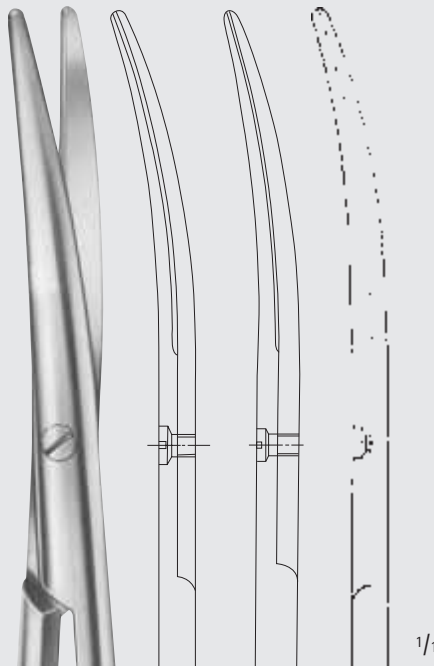

BC279R	BC281R	BC282R
260 mm	280 mm	285 mm
10 1/4"	11"	11 1/4"

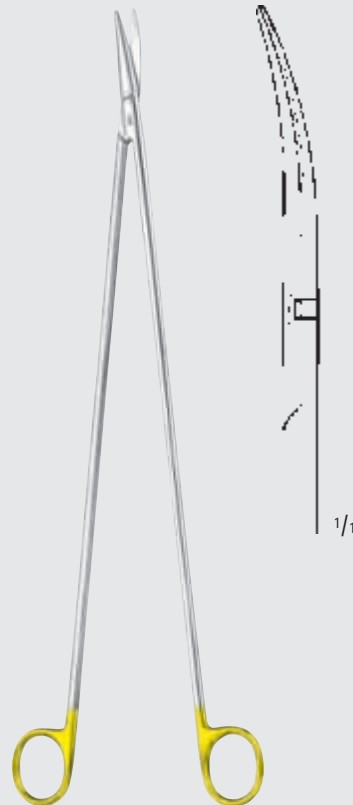

NELSON-METZENBAUM

BC285R

350 mm, 14"



MILLIMETERS

Scheren – Scissors

DUROTIP® Präparierscheren

DUROTIP® Dissecting Scissors

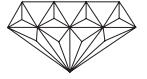

BC

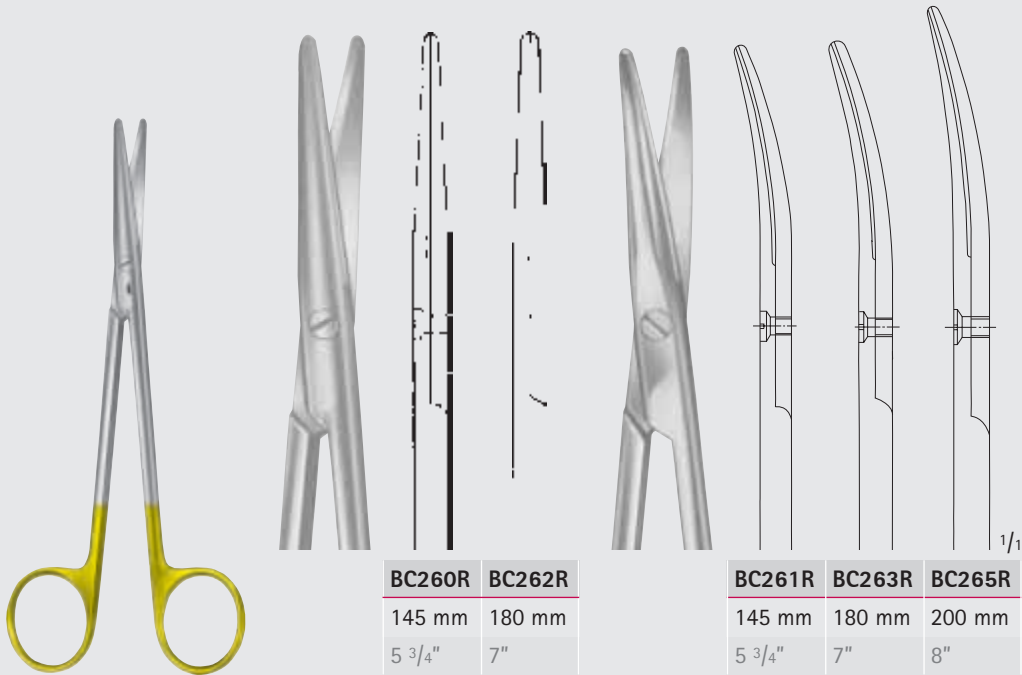

BC260R	BC262R
145 mm	180 mm
5 3/4"	7"

BC261R	BC263R	BC265R
145 mm	180 mm	200 mm
5 3/4"	7"	8"

METZENBAUM

BC260R-BC265R



BC266R
200 mm
9"

BC267R	BC289R
230 mm	300 mm
9"	12"

NELSON-METZENBAUM (MC INDOE)

BC266R-BC289R

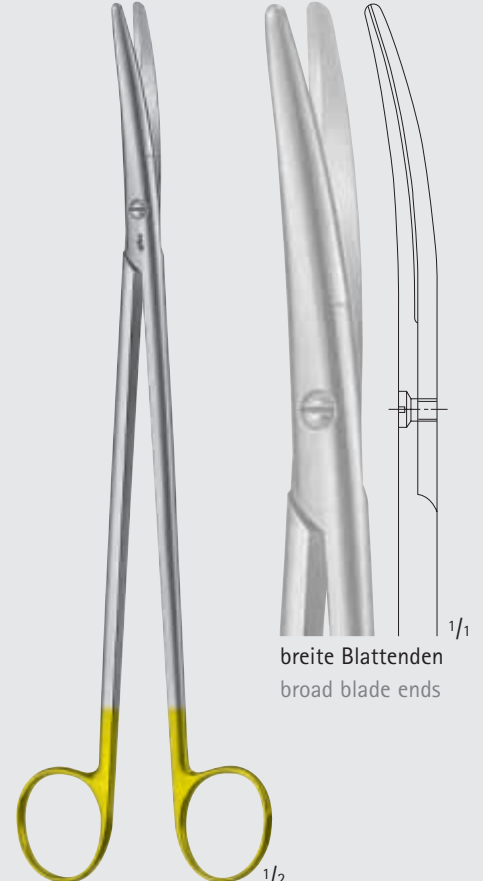

breite Blattenden
broad blade ends

METZENBAUM

BC287R

230 mm, 9"

INCHES

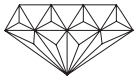

Scheren – Scissors
 DUROTIP® Scheren
 DUROTIP® Scissors

BC

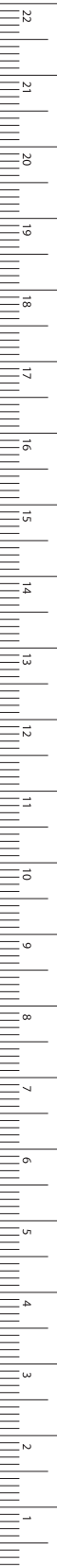

MILLIMETERS

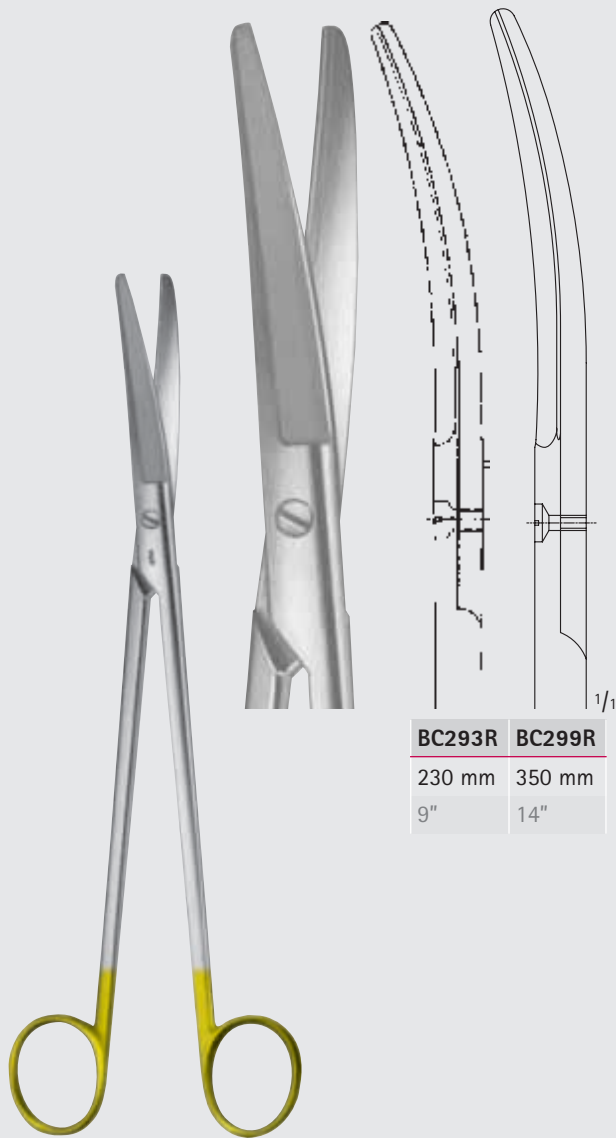

BC293R	BC299R
230 mm	350 mm
9"	14"

WERTHEIM

BC293R-BC299R

Präparierscheren
 Dissecting scissors

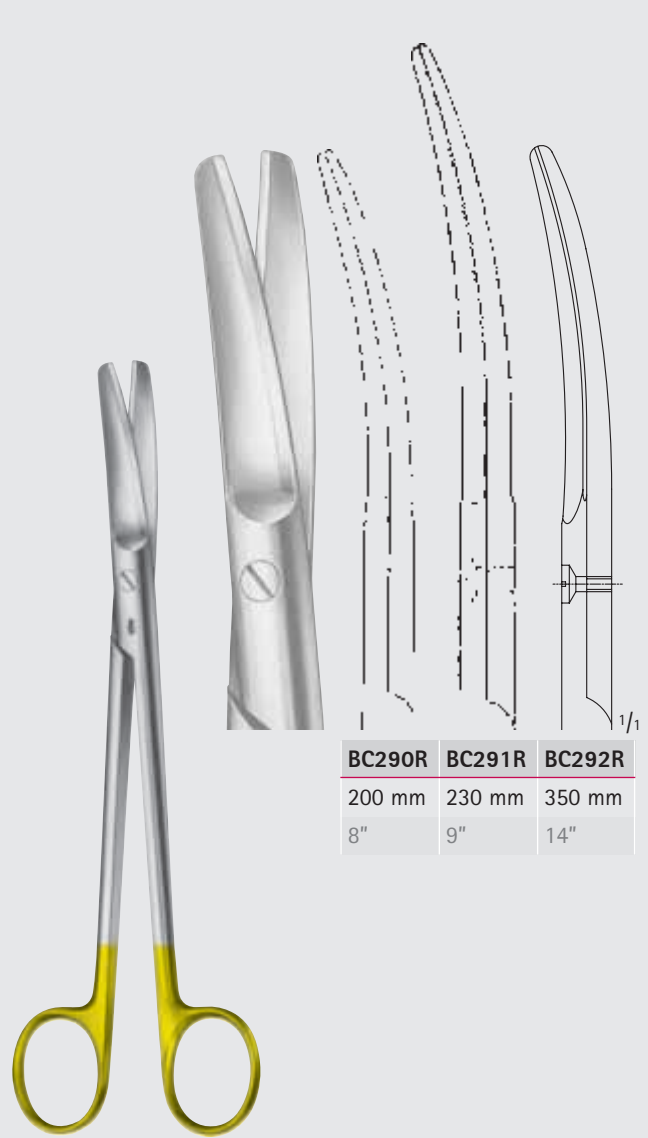

BC290R	BC291R	BC292R
200 mm	230 mm	350 mm
8"	9"	14"

SIMS

BC290R-BC292R

Uterusscheren
 Uterine scissors

Scheren – Scissors
 DUROTIP® Scheren
 DUROTIP® Scissors

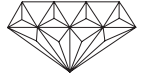

BC

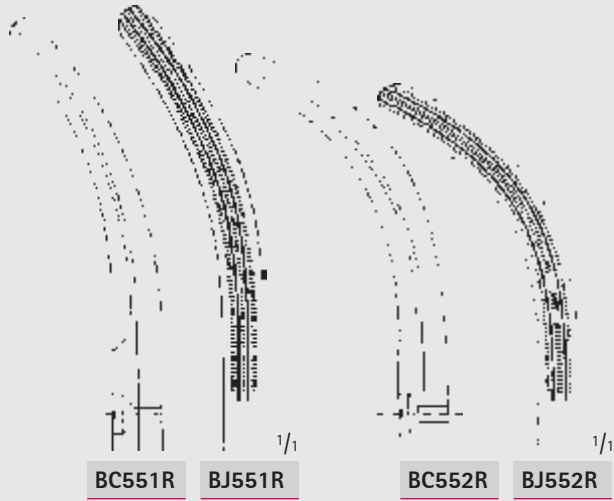

BC551R

BJ551R

BC552R

BJ552R



BC551R

255 mm
10"

BC552R

250 mm
10"

BC551R-BJ552R

Hysterektomiescheren, stark gebogen, passend zu den Parametriumklammern BJ551R und BJ552R.
 Hysterectomy scissors, strongly curved, fitting parametrium clamps BJ551R and BJ552R.

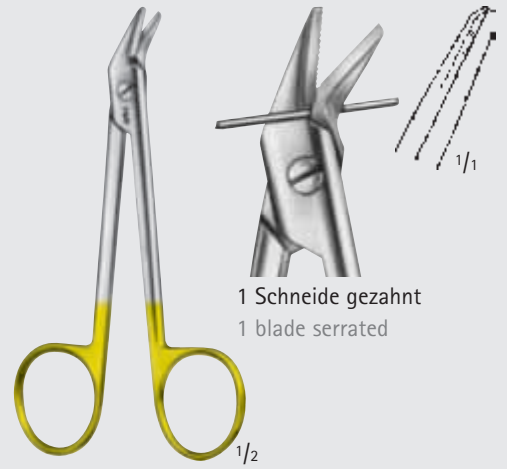

1 Schneide gezahnt
1 blade serrated

DP552R

Draht- und Bleischere
Wire cutting scissors
120 mm, 4 3/4"

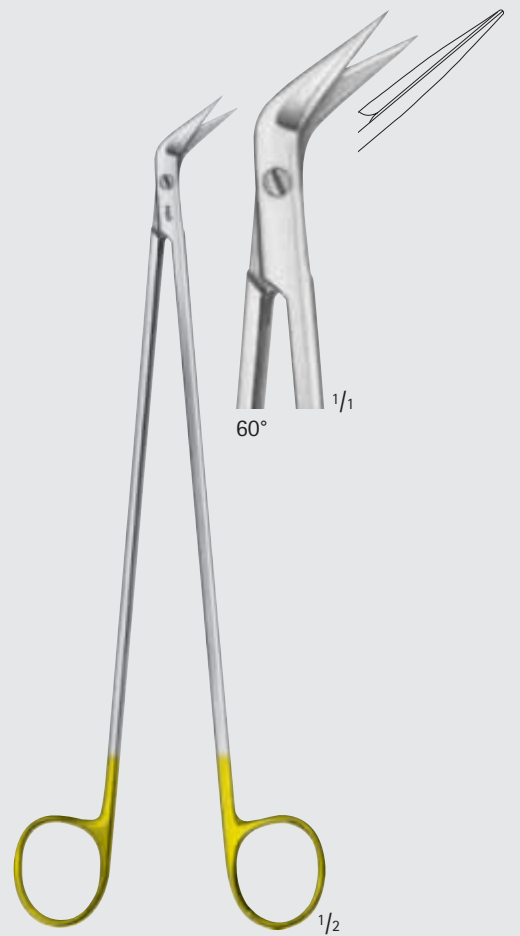

60°

DE BAKEY

BC245R

Gefäßschere
Vascular scissors
220 mm, 8 3/4"

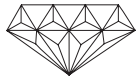

Scheren – Scissors

DUROTIP® Scheren mit **W**ellenschliff
DUROTIP® **W**avecut Scissors

Wellenschliff
verhindert das Herausgleiten
des Gewebes

Wavecut
prevents tissue
from slipping out



Artikel mit dem Zusatz **W**
sind auf einer Schnittfläche
mit Wellenschliff versehen
(bei Bestellungen bitte an-
geben - z.B. BC211W)

W directly after the
catalog number indicates
that the resp. item has one
serrated cutting edge.
(When ordering please
indicate together with the
catalog number e.g.
BC211W)

»grazil«

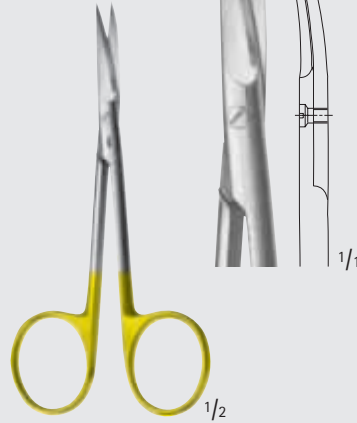

BC211W

Fadenschere
Ligature scissors
110 mm, 4 3/8"

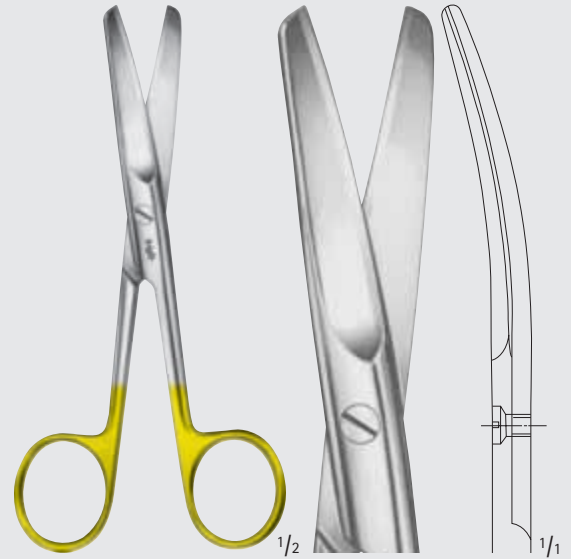

BC231W

Chirurgische Schere
Surgical Scissors
145 mm, 5 3/4"

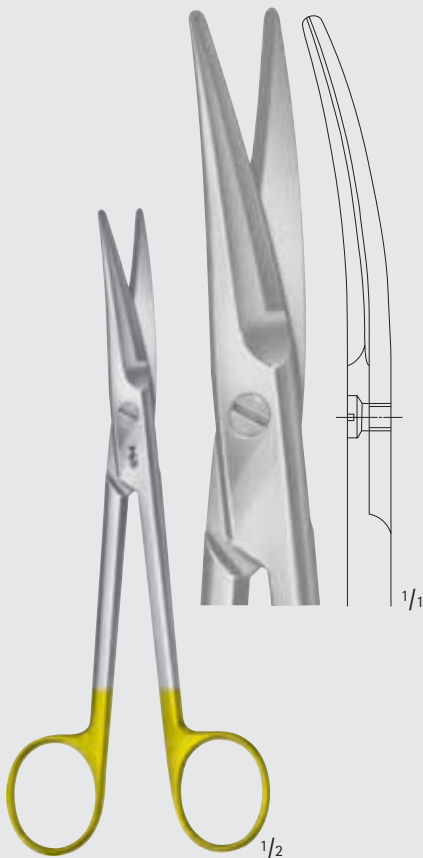

MAYO

BC253W

Präparierschere
Dissecting scissors
170 mm, 6 3/4"

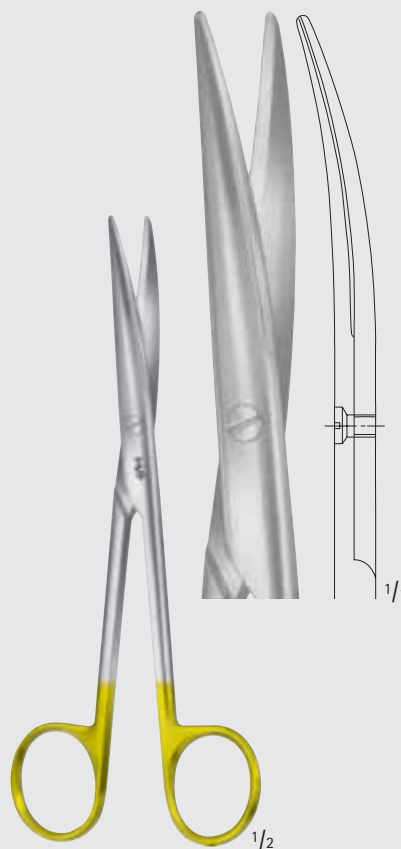

LEXER

BC283W

Präparierschere, schmal
Dissecting scissors, slender
165 mm, 6 1/2"

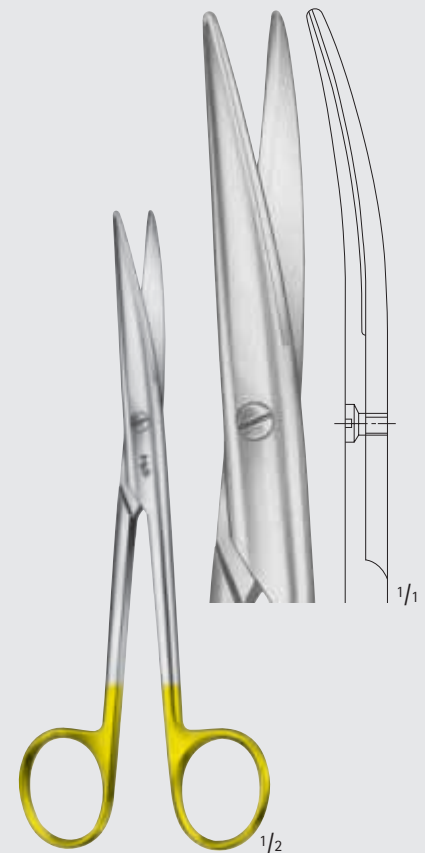

MAYO-LEXER

BC284W

Präparierschere
Dissecting scissors
165 mm, 6 1/2"

BC

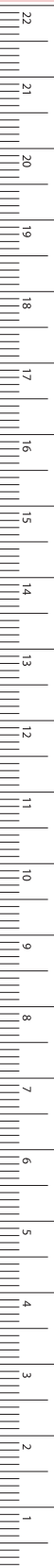

MILLIMETERS

Scheren – Scissors

DUROTIP® Präparierscheren mit **W**ellenschliff
 DUROTIP® **W**avecut Dissecting Scissors

»grazil«

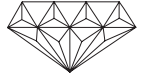

BC

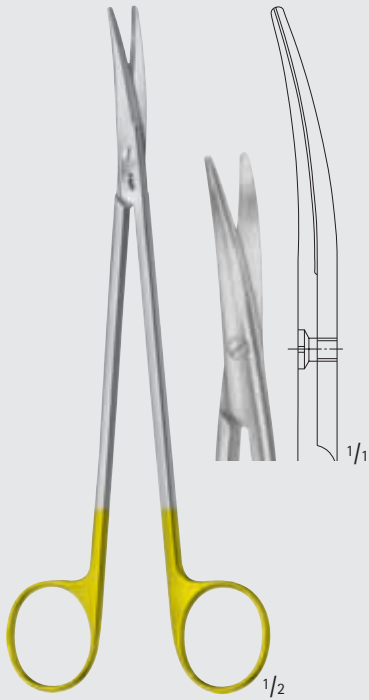

BC257W
 115 mm, 4 1/2"

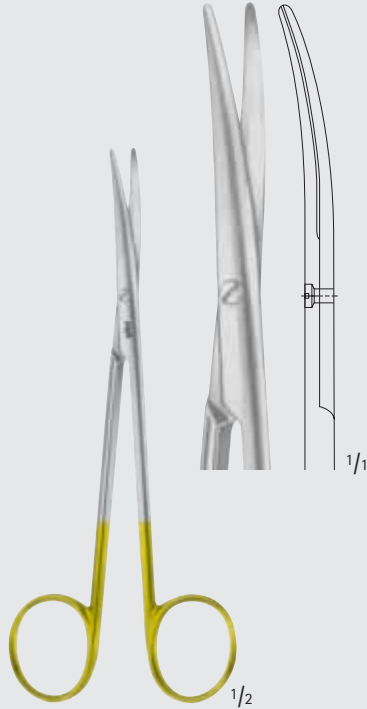

BABY-METZENBAUM
BC259W
 145 mm, 5 3/4"

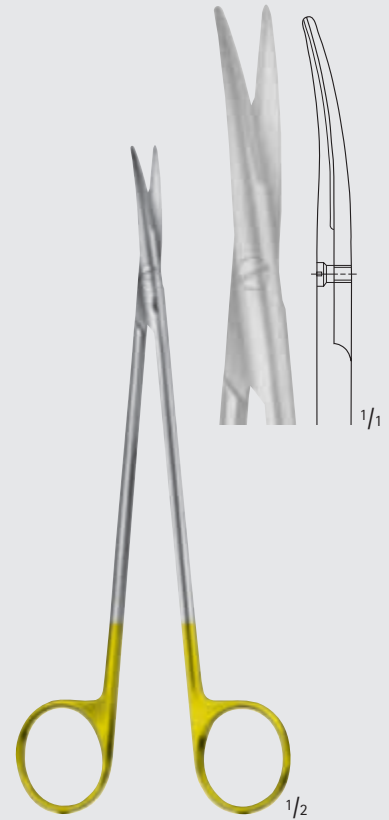

TÖNNIS-ADSON
BC273W
 175 mm, 7"



METZENBAUM
BC271W-BC277W

BC271W	BC275W	BC277W
180 mm	200 mm	230 mm
7"	8"	9"

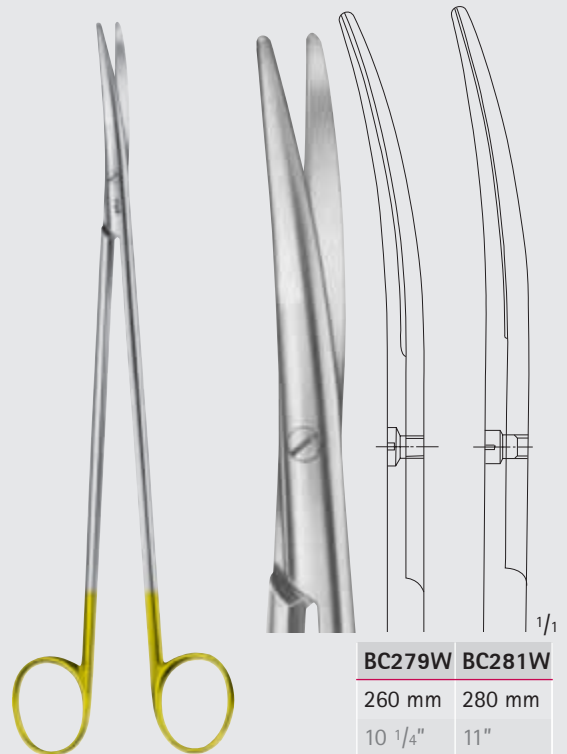

NELSON-METZENBAUM
BC279W-BC281W

BC279W	BC281W
260 mm	280 mm
10 1/4"	11"



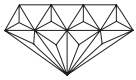

Scheren – Scissors

DUROTIP® Präparierscheren mit Wellenschliff
DUROTIP® Wavecut Dissecting Scissors

BC



BC261W	BC263W	BC265W
145 mm	180 mm	200 mm
5 3/4"	7"	8"

METZENBAUM

BC261W-BC265W

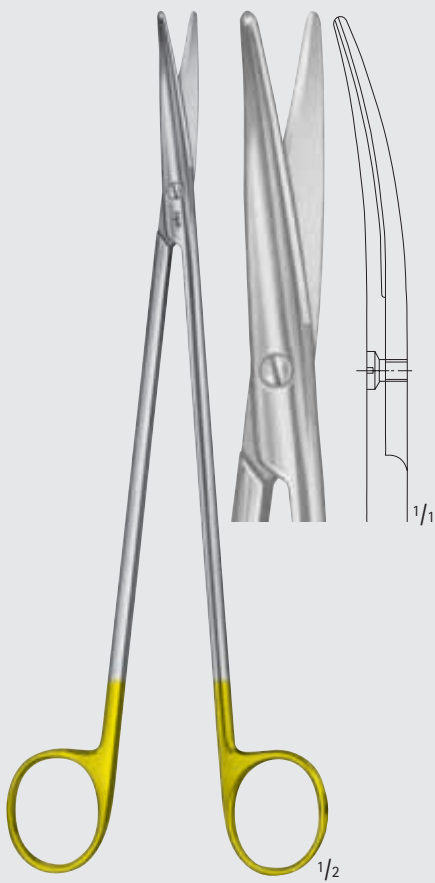

NELSON-METZENBAUM

BC267W

230 mm, 9"

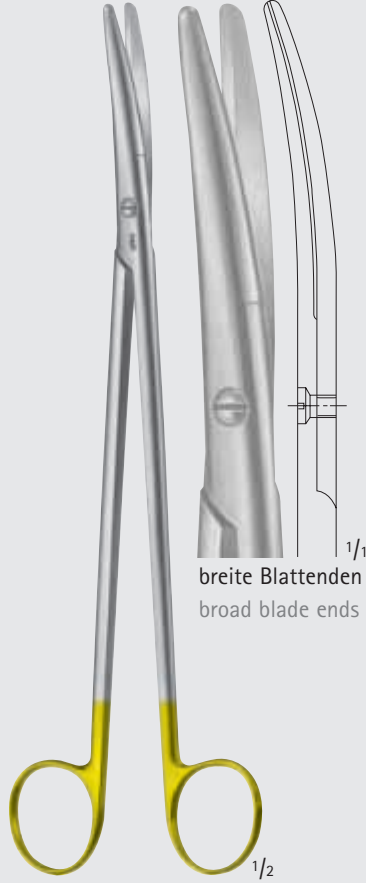

breite Blattenden
broad blade ends

METZENBAUM

BC287W

230 mm, 9"

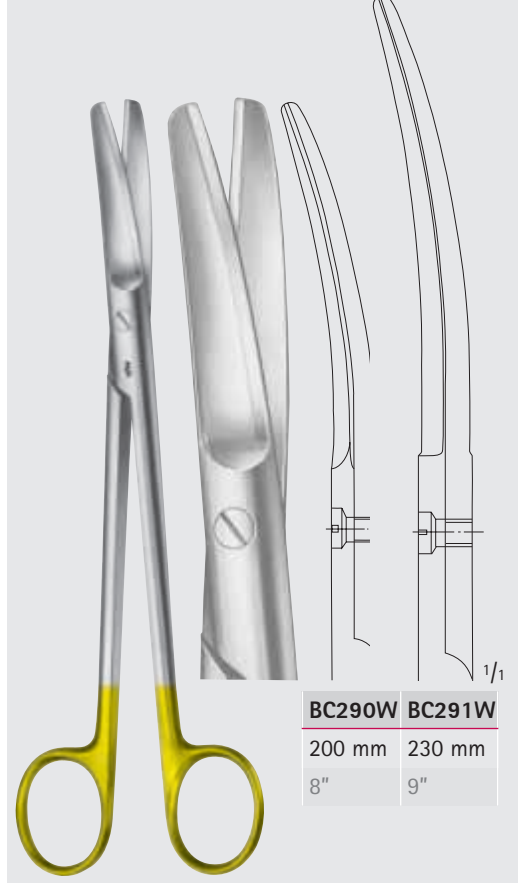

BC290W	BC291W
200 mm	230 mm
8"	9"

SIMS

BC290W-BC291W

Uterusscheren
Uterine scissors



MILLIMETERS

Scheren – Scissors

DUROTIP® Ligaturscheren mit Wellenschliff

DUROTIP® Wavecut Ligature Scissors

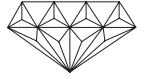

BC

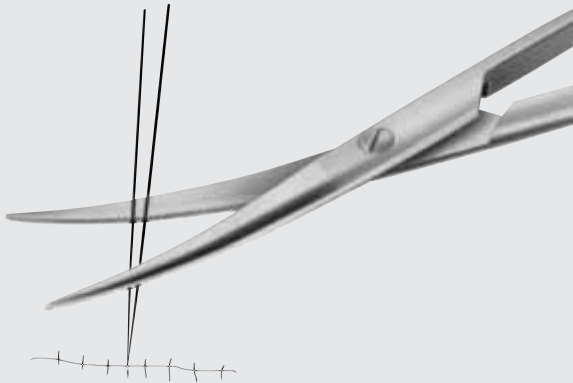

speziell zum Schneiden von Nahtmaterial

- Hartmetalleinlagen gewähren dauerhafte Schnittschärfe (auch im distalen Bereich der Scherenblätter)
- der Spezial-Wellenschliff verhindert das Abgleiten des Nahtmaterials
- DUROTIP®-Ligaturscheren sind gekennzeichnet mit 1 vergoldeten Ring

especially for cutting suture materials

- Carbide inserts guarantee permanent cutting edge (also in the distal area of the blades)
- Wavecut prevents suture materials from slipping out
- DUROTIP® ligature scissors are identified by 1 goldplated ring



BC294W-BC298W

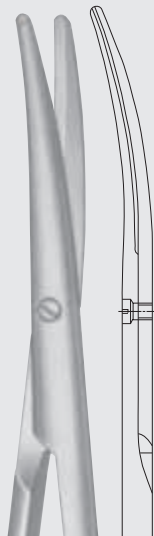

BC294W

145 mm

5 3/4"

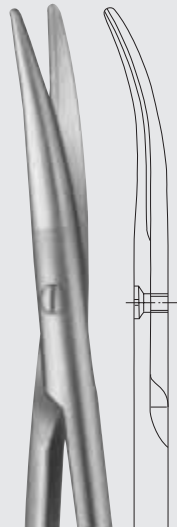

BC295W

180 mm

7"

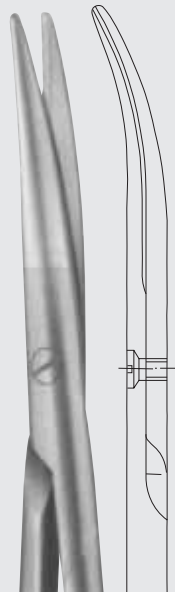

BC296W

230 mm

9"

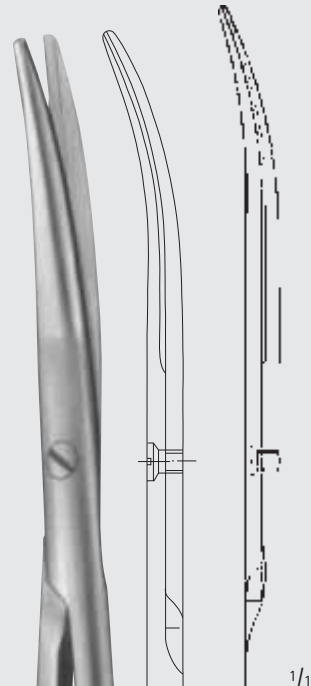

BC297W

260 mm

10 1/4"

BC298W

350 mm

14"

1/1



Scheren – Scissors
Präparierscheren Noir
Dissecting Scissors Noir

BC

»grazil«



BC257B

115 mm, 4 1/2"

»grazil«



BABY-METZENBAUM

BC259B

145 mm, 5 3/4"

»grazil«

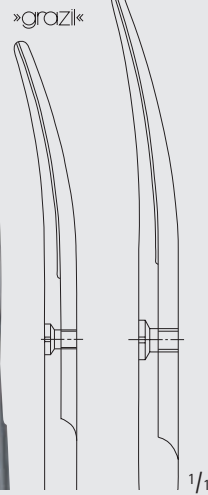

BC271B

180 mm

7"

»grazil«

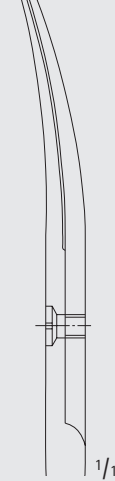

BC275B

200 mm

8"

BC261B

145 mm

5 3/4"

BC263B

180 mm

7"

BC265B

200 mm

8"



METZENBAUM

BC261B-BC275B

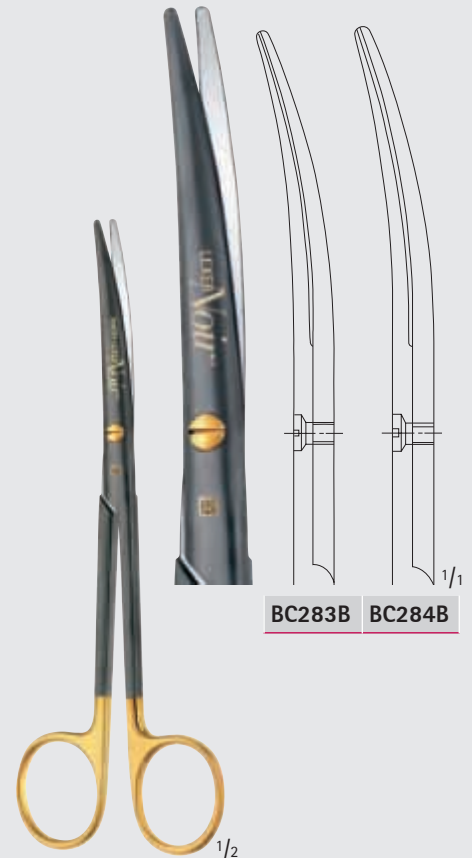

MAYO-LEXER

BC283B-BC284B

165 mm, 6 1/2"



MILLIMETERS

Scheren – Scissors

Präparierscheren Noir mit Wellenschliff

Wavecut Dissecting Scissors Noir



Wellenschliff verhindert das Herausgleiten des Gewebes während des Schneidens

Wavecut prevents tissue from slipping out during the cutting process



BC257WB

115 mm, 4 1/2"



BABY-METZENBAUM

BC259WB

145 mm, 5 3/4"

BC





Scheren – Scissors

Präparierscheren Noir mit Wellenschliff
Wavecut Dissecting Scissors Noir



METZENBAUM

BC261WB-BC275WB

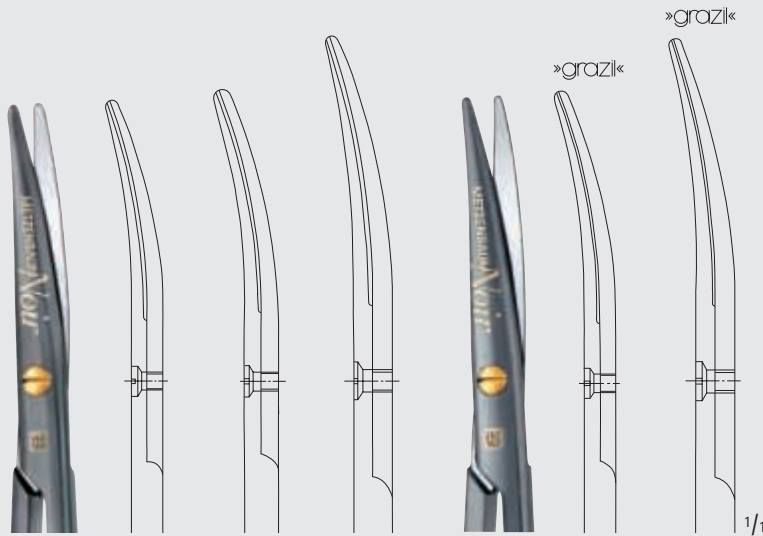

BC261WB	BC263WB	BC265WB
145 mm	180 mm	200 mm
5 3/4"	7"	8"

BC271WB	BC275WB
180 mm	200 mm
7"	8"



MAYO-LEXER

BC283WB-BC284WB

165 mm, 6 1/2"



BC283WB BC284WB

BC

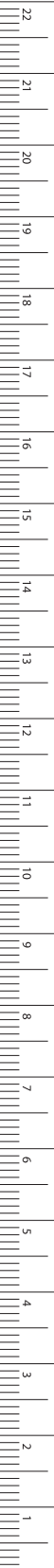

MILLIMETERS

Scheren – Scissors

Mikro-Gefäßscheren

Micro Vascular Scissors

BC



1/1

DIETHRICH-POTTS
180 mm, 7"



Scheren – Scissors

Mikro-Gefäßscheren
Micro Vascular Scissors

BC

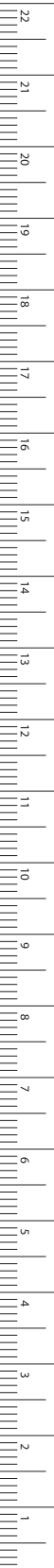

25°



BC522R

45°

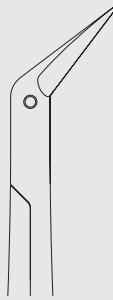

BC523R

60°

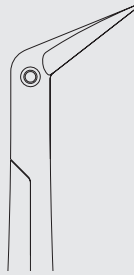

BC524R

90°

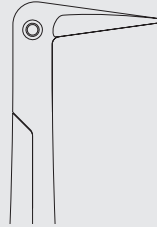

BC525R

125°

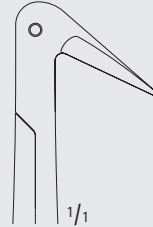

BC526R

Standard Blatt
Standard blade



BC531R

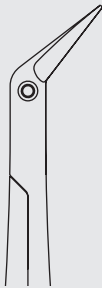

BC532R

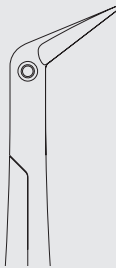

BC533R



BC534R



BC535R

Sehr feines Blatt
Delicate blade

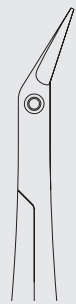

BC515R



BC516R



BC517R

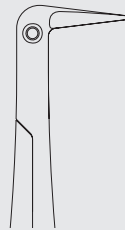

BC518R



BC519R

Extrem feines Blatt
Ultra delicate blade

MILLIMETERS

Scheren – Scissors
 Gefäßscheren
 Cardiovascular Scissors

BC

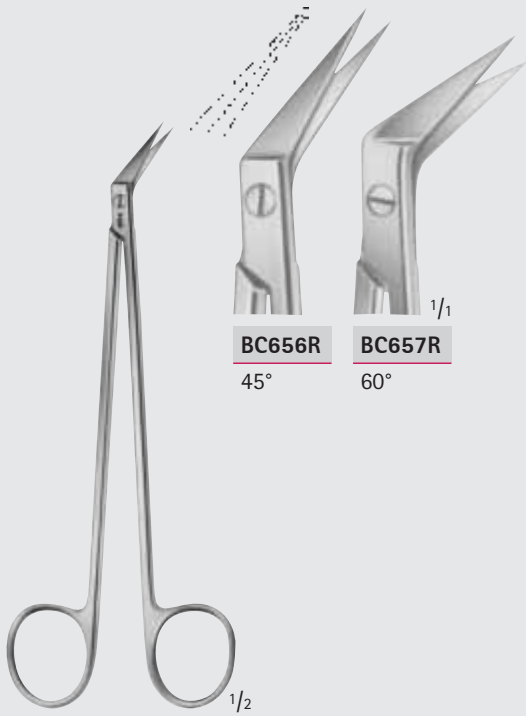

DE BAKEY

BC656R-BC657R

155 mm, 6"

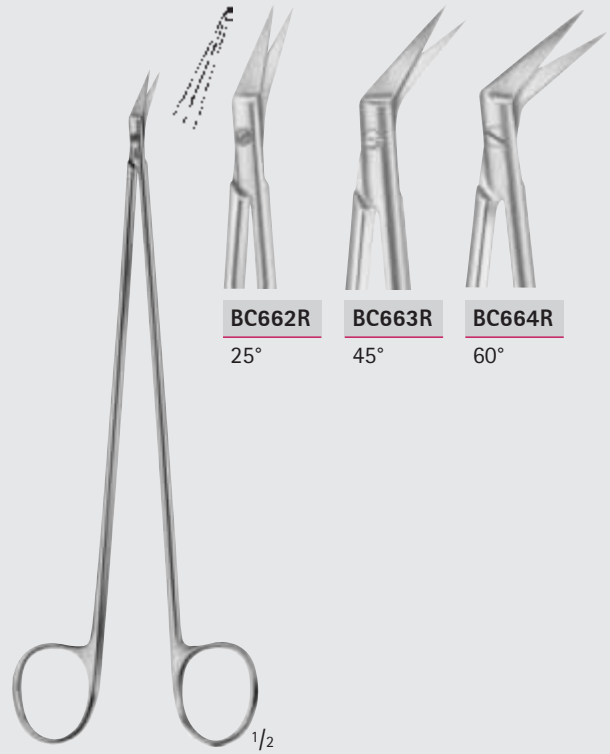

DIETRICH-HEGEMANN

BC662R-BC664R

180 mm, 7"

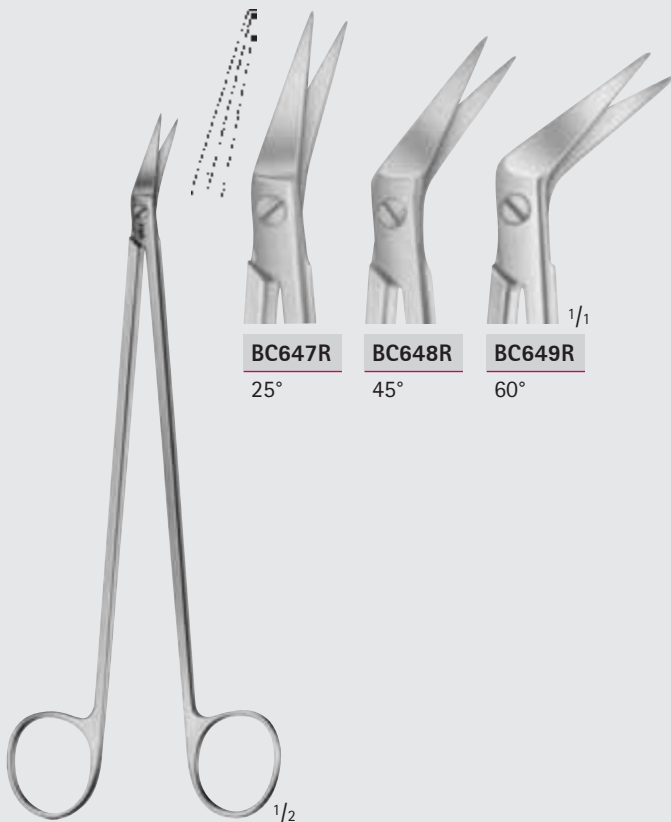

POTTS-DE MARTEL

BC647R-BC649R

185 mm, 7 1/4"

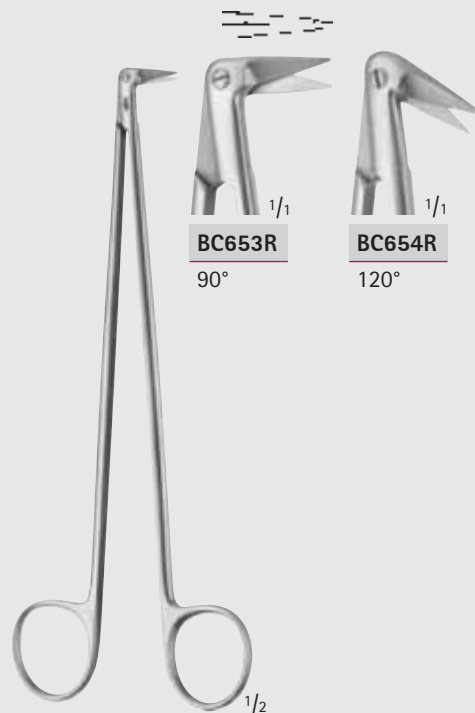

DIETRICH

BC653R-BC654R

170 mm, 6 3/4"



Scheren – Scissors
 Gefäßscheren
 Cardiovascular Scissors

BC

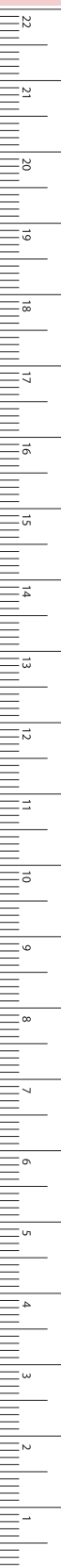

MILLIMETERS

55°
aufgebogen
55°
angled on flat

POTTS-SMITH
BC646R
 Gefäßschere
 Cardiovascular scissors
 180 mm, 7"

60°

POTTS-SMITH
BC652R
 Gefäßschere
 Cardiovascular scissors
 180 mm, 7"

POTTS-DE
MARTEL
BC650R
60°

MILLS
BC651R
60°

BC650R-BC651R
 Gefäßscheren
 Cardiovascular scissors
 220 mm, 8 3/4"

45°

DE BAKEY
BC669R
 Offset-Schere, S-förmig
 Offset scissors, s-shaped
 155 mm, 6"

55°

FAVOLORO
BC670R
 Gefäßschere
 Cardiovascular scissors
 140 mm, 5 1/2"

Scheren – Scissors

Scheren für Gefäß- und Neurochirurgie
Scissors for Vascular and Neuro Surgery

BC

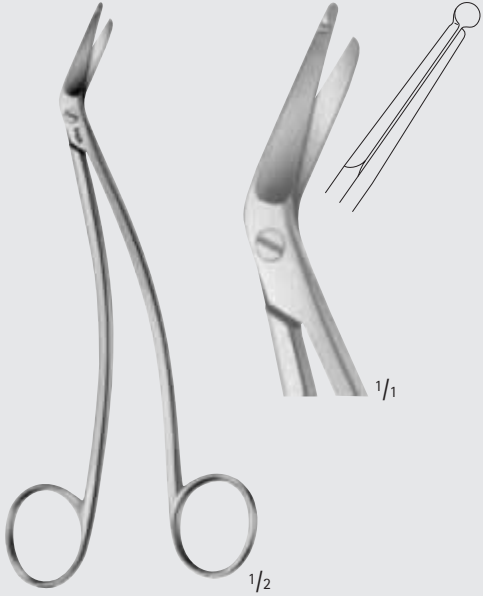

SCHMIEDEN-TAYLOR

BC660R

Duraschere

Dura scissors

155 mm, 6"

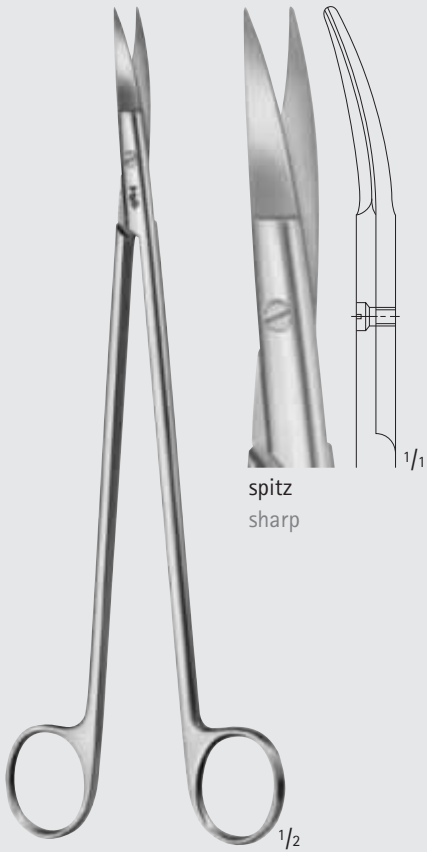

STRULLY

BC644R

Gefäßschere

Vascular scissors

220 mm, 8 3/4"

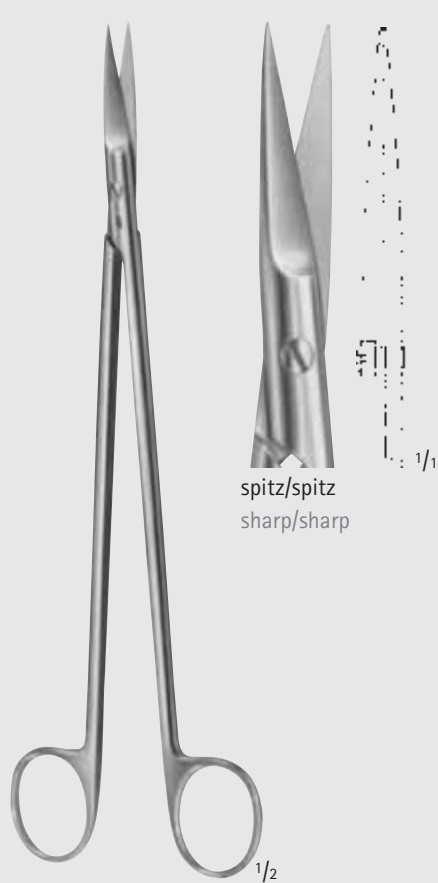

BC642R

Gefäßschere

Vascular scissors

225 mm, 9"





Scheren – Scissors

Scheren für Gefäß- und Neurochirurgie
Scissors for Vascular and Neuro Surgery

BC

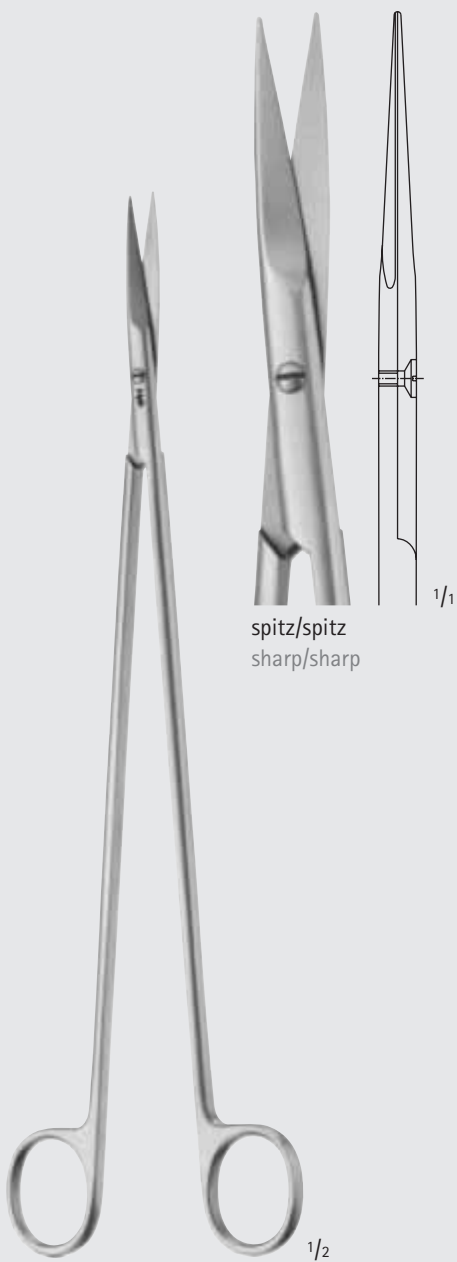

spitz/spitz
sharp/sharp

1/1

1/2

BARRÉ

BC715R

280 mm, 11"

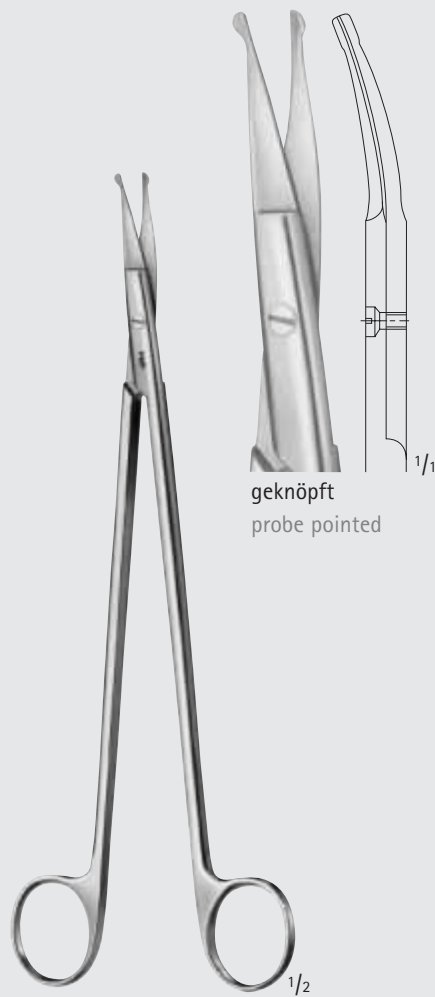

geknöpft
probe pointed

1/1

1/2

STRULLY

BC645R

220 mm, 8 3/4"

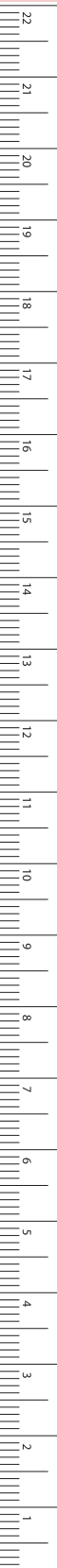

MILLIMETERS

Scheren – Scissors
 Scheren für die Gefäßchirurgie
 Scissors for Vascular Surgery

BC



BC658R	BC659R
gerade	gebogen
sehr fein	sehr fein
straight	curved
very	very
delicate	delicate

BC658R-BC659R
 190 mm, 7 1/2"

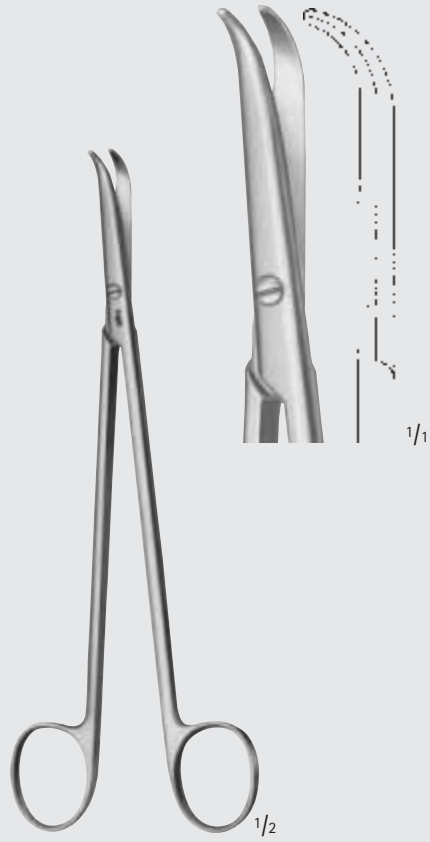

THOREK
BC636R
 180 mm, 7"

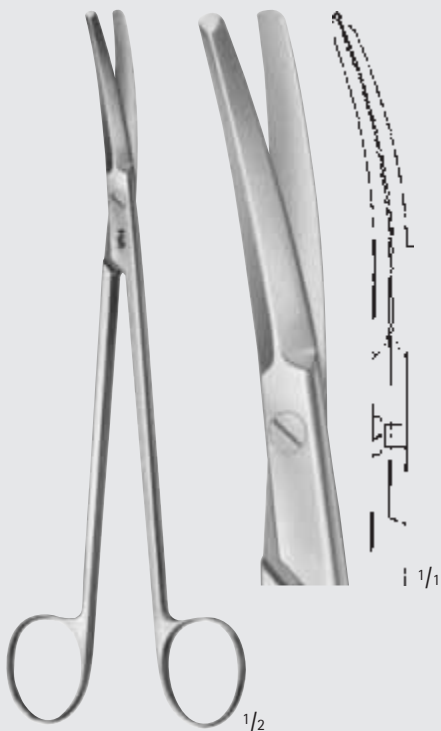

POTTS-SMITH
BC643R
 190 mm, 7 1/2"

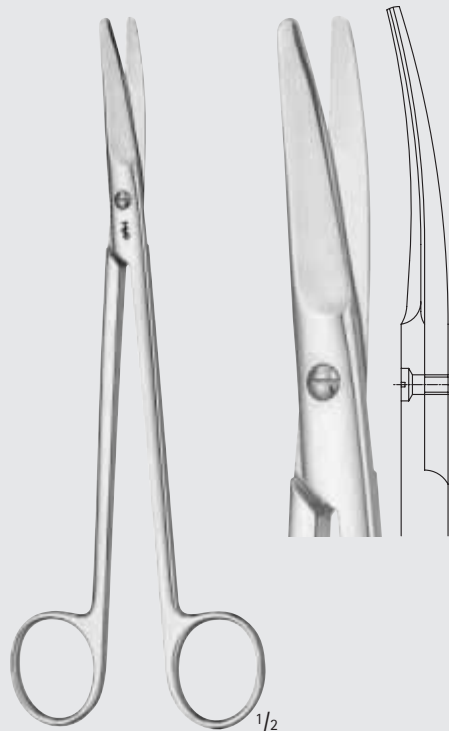

COOLEY
BC597R
 190 mm, 7 1/2"



Scheren – Scissors
Scheren für Gefäßchirurgie
Scissors for Vascular Surgery

BC

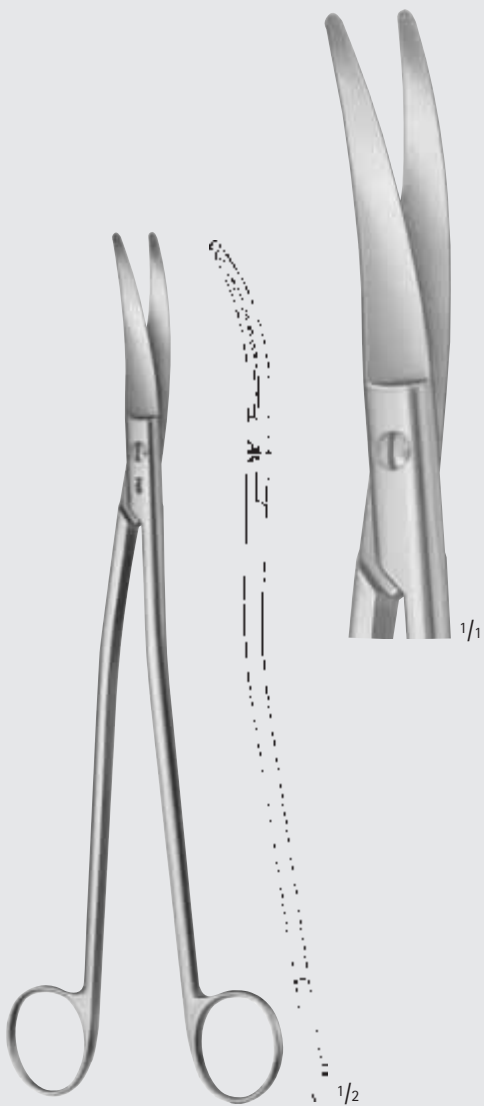

KLINKENBERG-LOTH

BC640R

230 mm, 9"

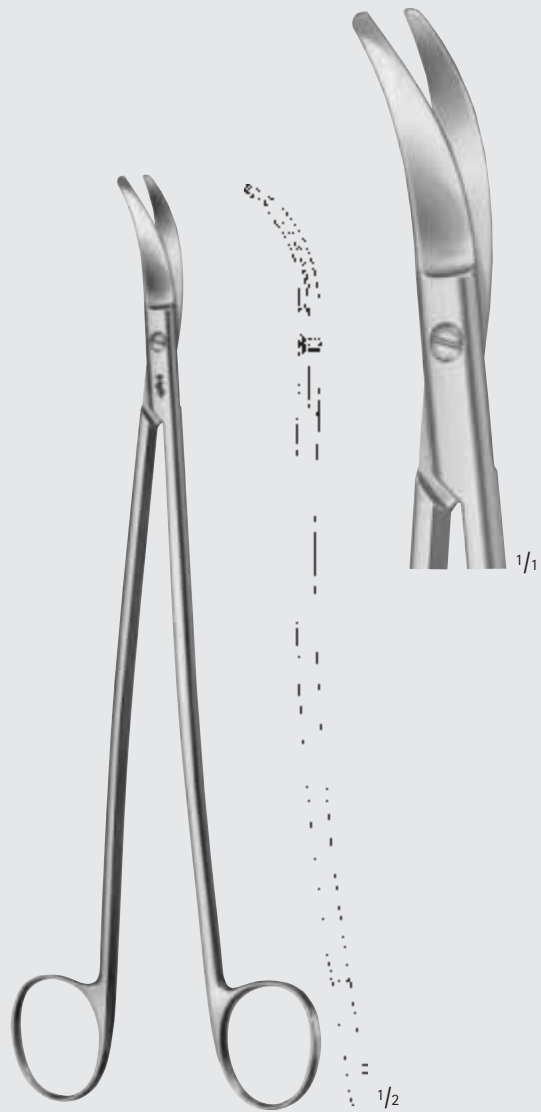

SATINSKY

BC641R

245 mm, 9 3/4"

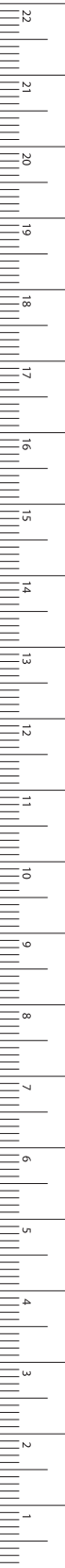

MILLIMETERS

Scheren – Scissors
Knochenscheren
Bone Shears

BC



KILLIAN

OP130R

200 mm, 8"



MÜHLING

FO216R

210 mm, 8 1/4"



Scheren – Scissors

Scheren für Operation in der Tiefe und für Gynäkologie
Scissors for Deep Operations and for Gynecology

BC



SIMS

BC721R-BC743R



BC721R	BC723R
200 mm	230 mm
8"	9"



BC741R	BC743R
200 mm	230 mm
8"	9"



SIMS

BC746R-BC748R



BC746R	BC748R
200 mm	230 mm
8"	9"

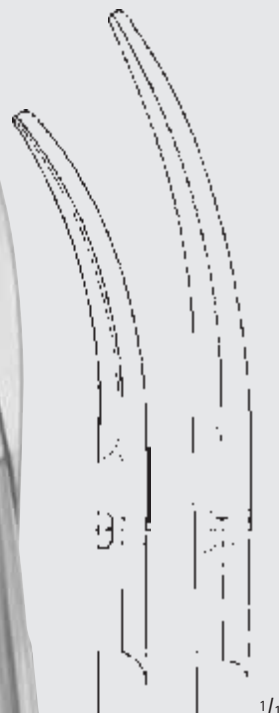

MILLIMETERS

Scheren – Scissors

Scheren für Operation in der Tiefe und für Gynäkologie
Scissors for Deep Operations and for Gynecology

BC

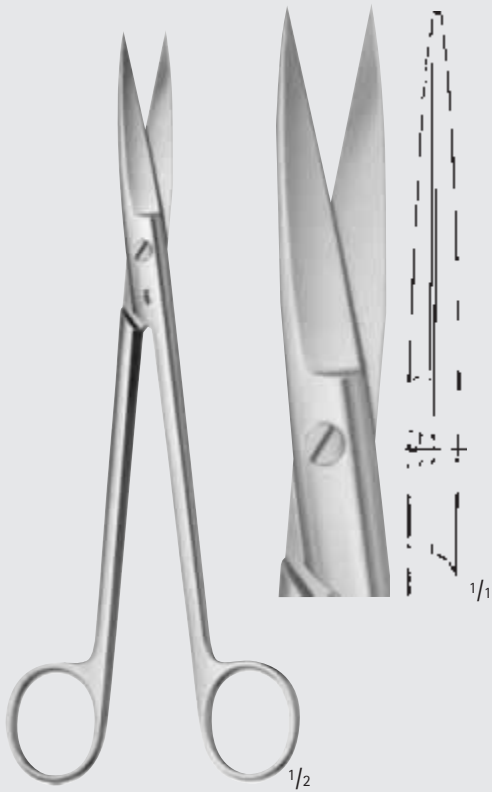

SIMS

BC731R

200 mm, 8"

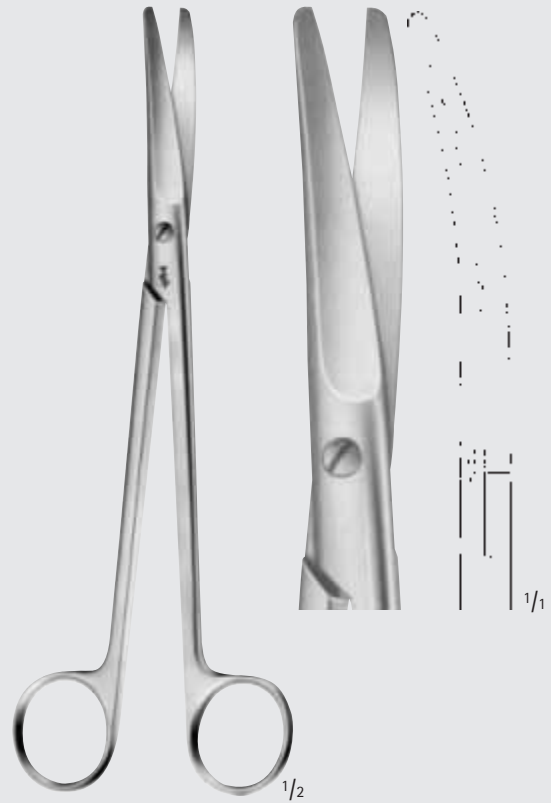

SIMS

BC708R

210 mm, 8 1/4"

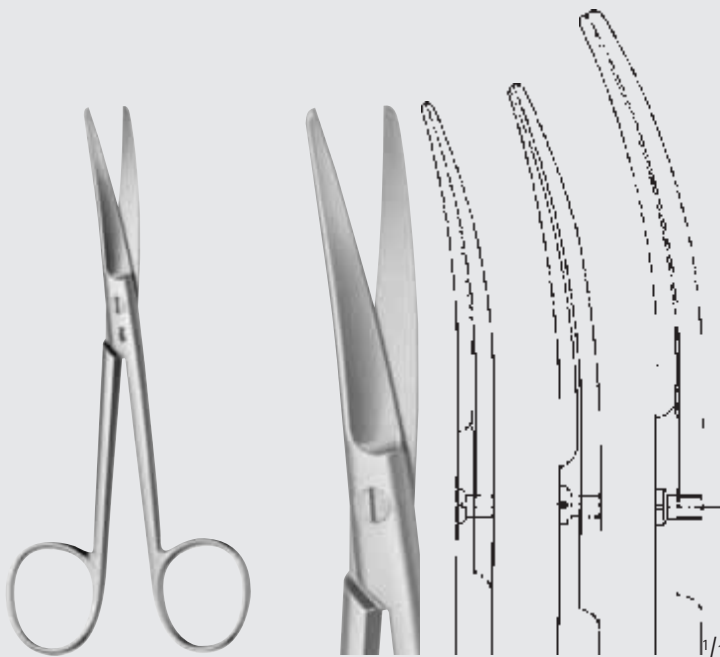

WERTHEIM

BC702R-BC704R

BC702R	BC703R	BC704R
145 mm	200 mm	230 mm
5 3/4"	8"	9"



Scheren – Scissors

Scheren für Operation in der Tiefe und für Gynäkologie
Scissors for Deep Operations and for Gynecology

BC

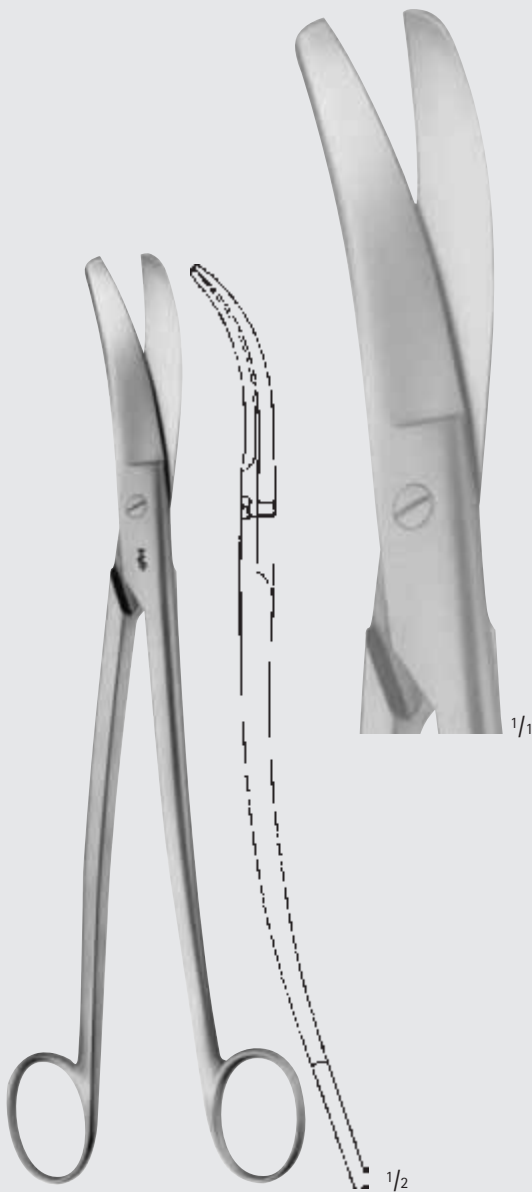

SIEBOLD

BC760R

Uterusschere
Uterine scissors
245 mm, 9 3/4"

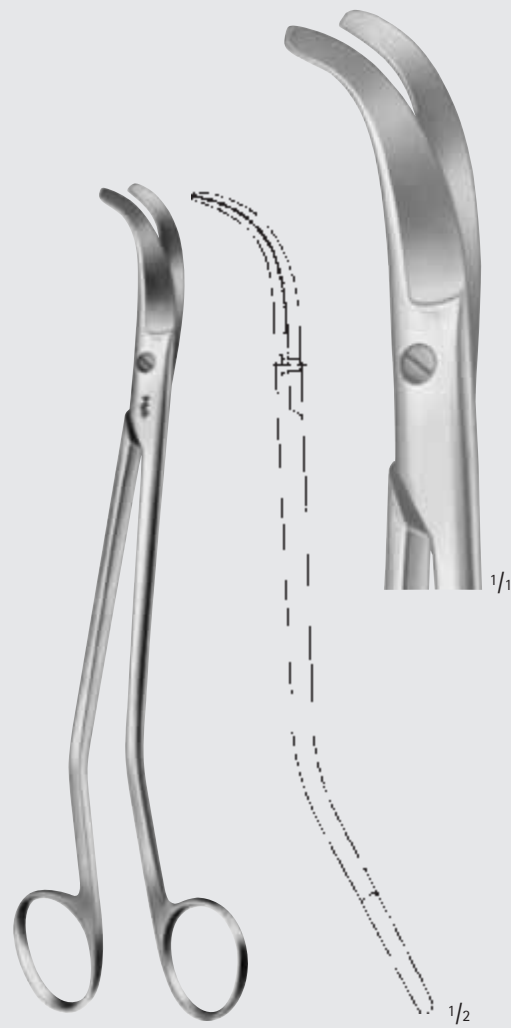

BOZEMANN

BC761R

Uterusschere
Uterine scissors
220 mm, 8 3/4"



MILLIMETERS

Scheren – Scissors

Scheren für Operation in der Tiefe und für Gynäkologie
Scissors for Deep Operations and for Gynecology

BC

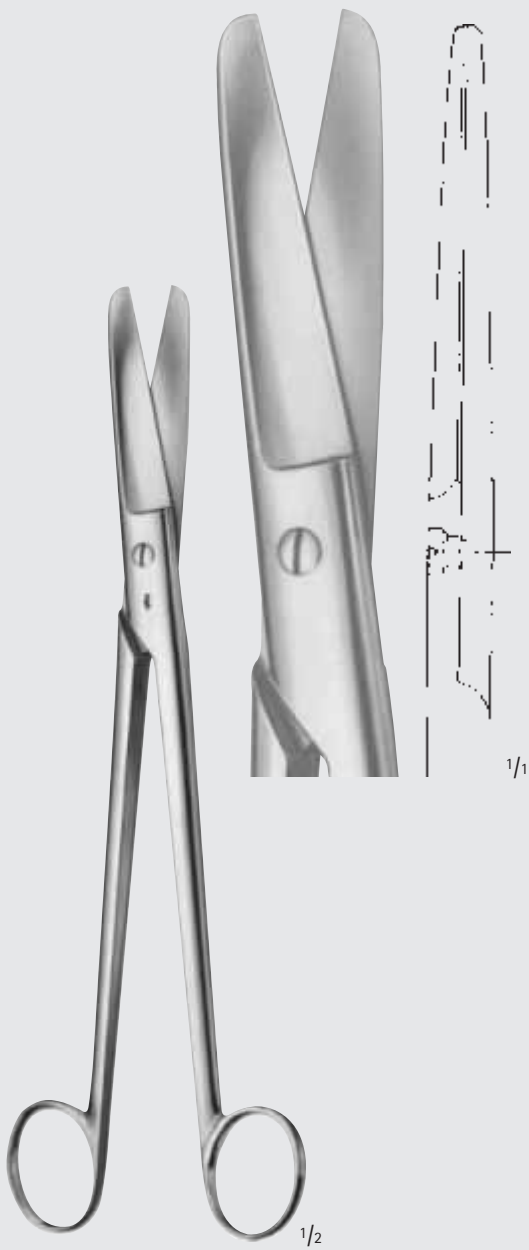

SIMS-SIEBOLD

BC762R

Uterusschere
Uterine scissors
250 mm, 10"

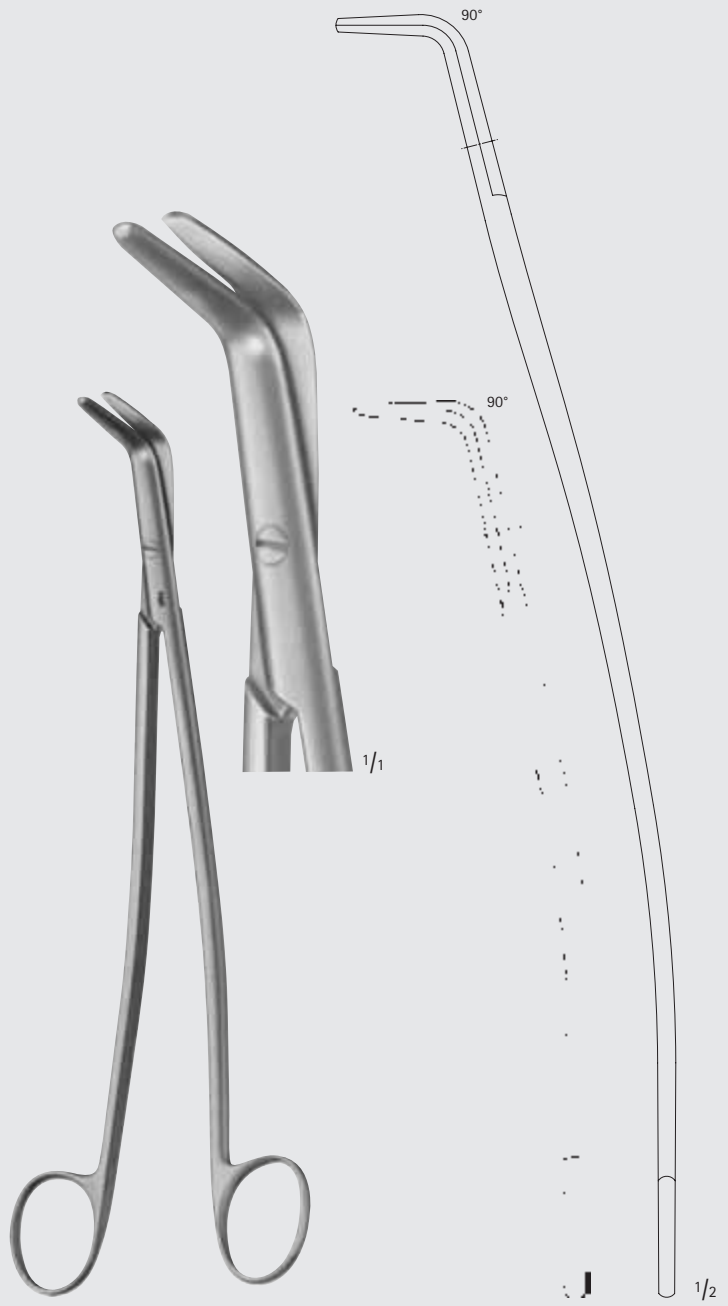

KIEBACK

BC763R-BC765R

Parametriumscheren
Parametrium scissors

BC763R	BC765R
240 mm	350 mm
9 1/2"	14"



Scheren – Scissors

Scheren für Operation in der Tiefe und für Gynäkologie
Scissors for Deep Operations and for Gynecology

BC



BC764R	BC766R
260 mm	350 mm
10 1/4"	9 1/2"

KIEBACK

BC764R-BC766R

Parametriumscheren, seitwärts gebogen, 1 Blatt mit Knopfspitze
Parametrium scissors, curved to side, with 1 probe pointed blade



MILLIMETERS

Scheren – Scissors

Chirurgische Scheren, kräftige Modelle
Surgical Scissors, Heavy Patterns

BC



BC771R

Bauchdeckenschere
Abdominal scissors
160 mm, 6 1/4"



BC774R

Bauchdeckenschere
Abdominal scissors
180 mm, 7"



BC772R-BC776R

Bauchdeckenscheren
Abdominal scissors

BC772R	BC776R
160 mm	180 mm
6 1/4"	7"



Scheren – Scissors
Scheren für Geburtshilfe
Scissors for Obstetrics

BC



SCHUHMACHER

ET150R

Nabelschnurschere
Umbilical cord scissors
155 mm, 6"

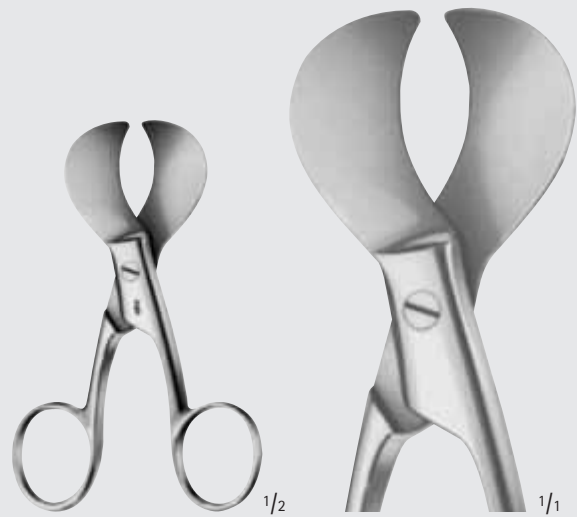

ET152R

Nabelschnurschere
Umbilical cord scissors
105 mm, 4 1/8"

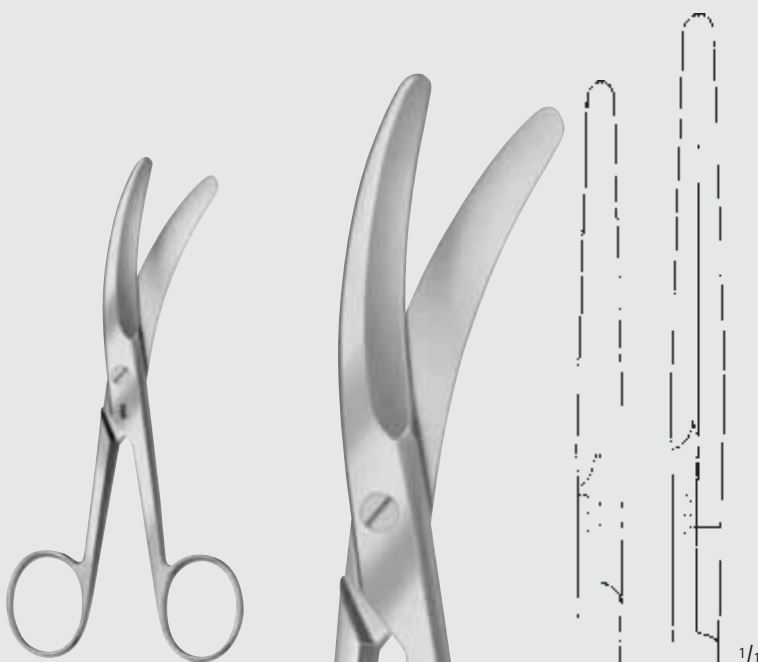

BC796R-BC797R

Nabelschnurscheren
Umbilical cord scissors

BC796R	BC797R
135 mm	160 mm
5 1/4"	6 1/4"



MILLIMETERS

Scheren – Scissors

Scheren für Geburtshilfe

Scissors for Obstetrics

BC



BRAUN-STADLER

ET140R-ET141R

Dammscheren

Episiotomy scissors



1/1

ET140R

145 mm

5 3/4"



1/1

ET141R

200 mm

8"



1/1

ET142R

Dammschere

Episiotomy scissors

240 mm, 9 1/2"

1/2

Scheren – Scissors
 Darmscheren, Rektumschere
 Bowel Scissors, Rectal Scissors

BC

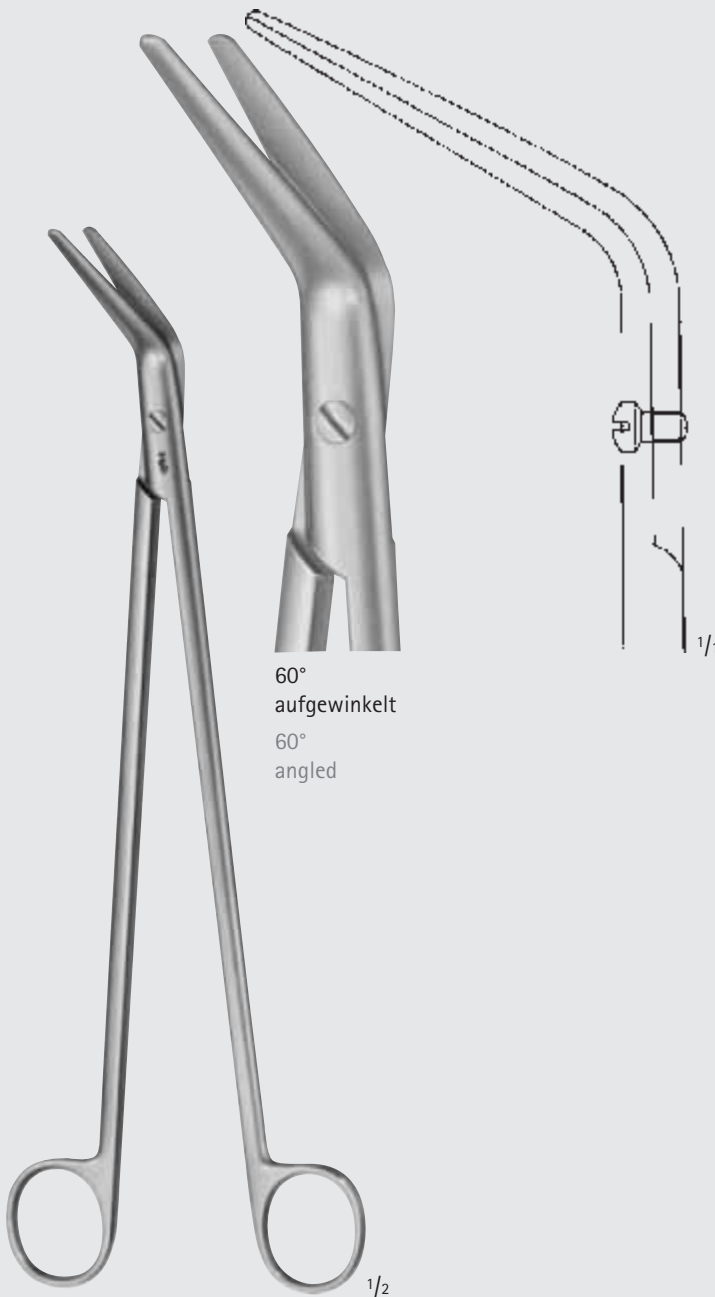

60°
aufgewinkelt
60°
angled

BC624R

Präparierschere
zum Durchtrennen des Darms nach
erfolgter Naht mit einem Naht-Gerät
Dissecting scissors
for cutting of the bowel after
suturing with suture device
280 mm, 11"

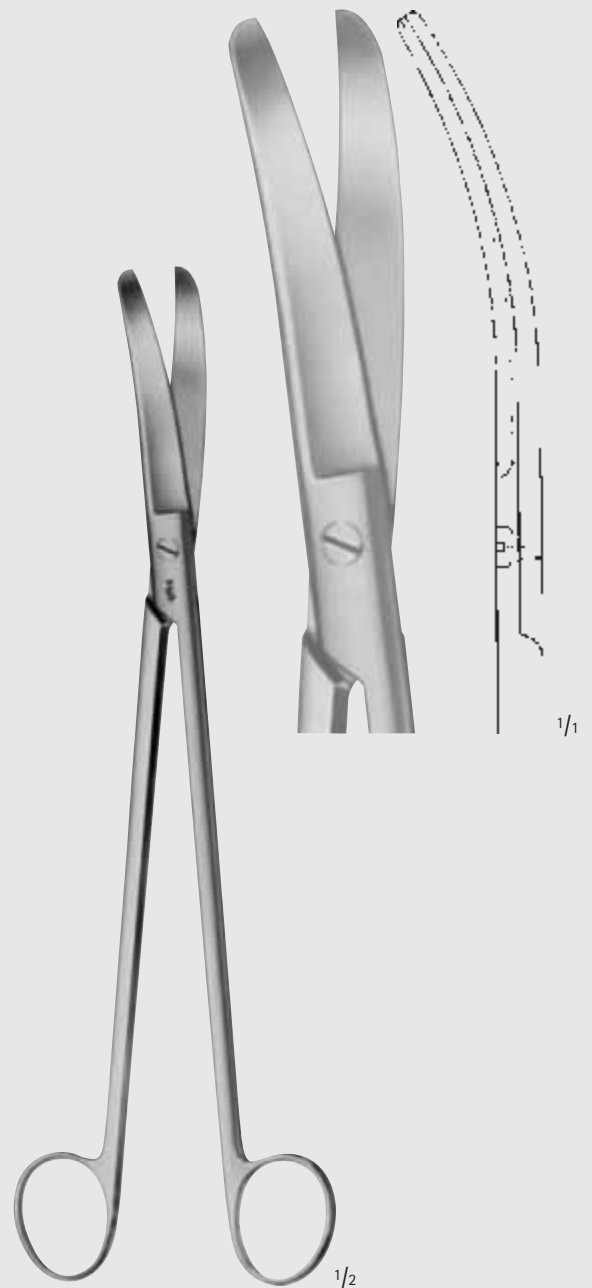

LLOYD-DAVIES (GOLIGHER'S)

BC621R

Rektumschere
Rectal scissors
270 mm, 10 3/4"



Scheren – Scissors

Rektumscheren

Rectal Scissors

BC

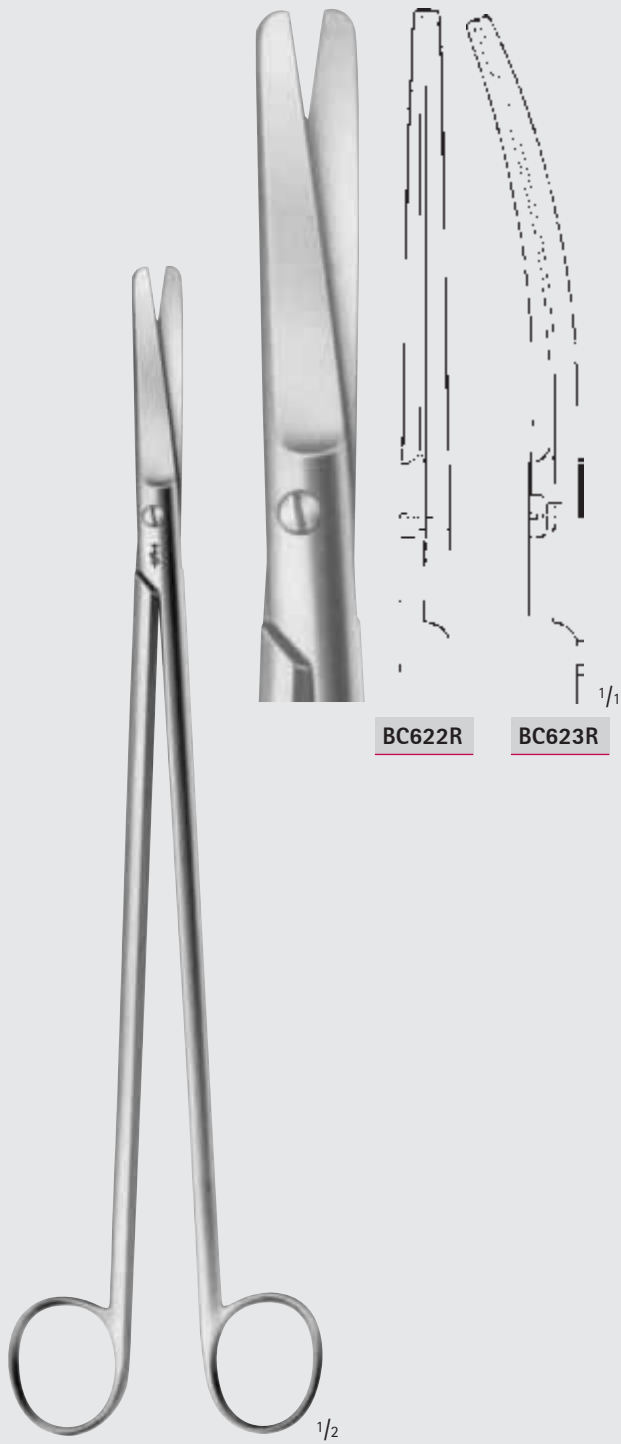

BC622R

BC623R

STELZNER

BC622R-BC623R

Rektumscheren

Rectal scissors

310 mm, 12 3/8"



BC617R

Rektumschere

Rectal scissors

325 mm, 13"



Scheren – Scissors
Rektumschere
Rectal Scissors

BC

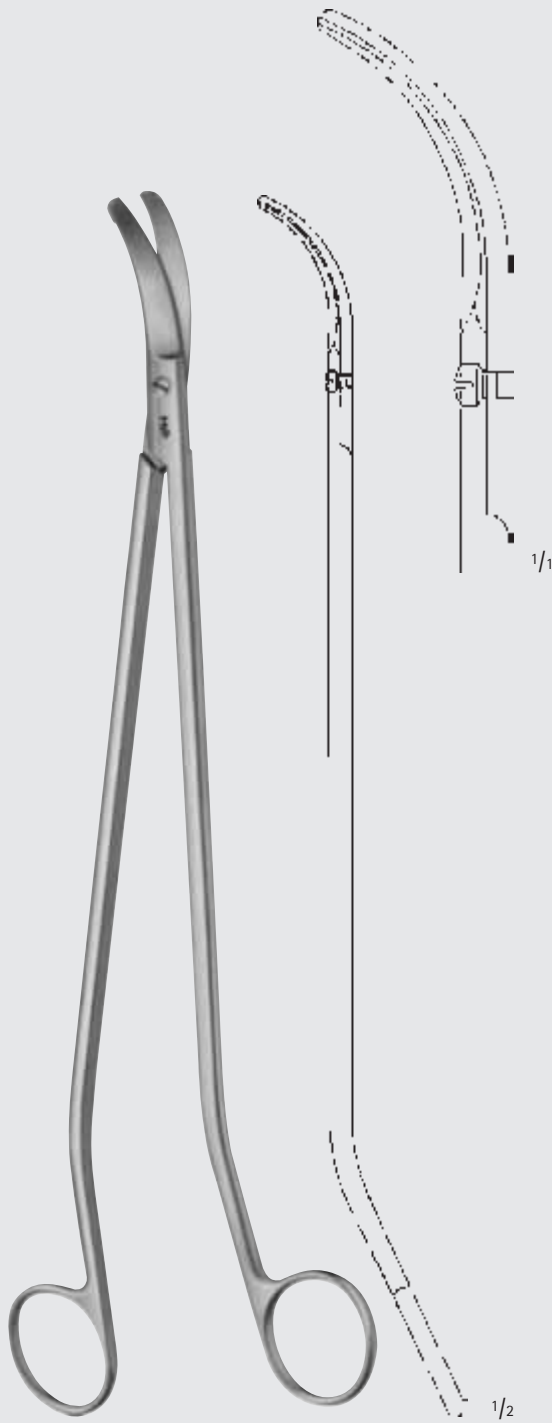

MÜLLER

BC627R

S-förmig

S-shaped

325 mm, 13"



MILLIMETERS

Scheren – Scissors

Ligaturscheren

Ligature Scissors

BC



BC801R	BC802R
90 mm	115 mm
3 1/2"	4 1/2"

SPENCER

BC801R-BC802R



BC803R

135 mm, 5 1/4"



NORTHBENT

BC805R

120 mm, 4 3/4"



Scheren – Scissors
 Draht- und Blehscheren
 Wire Cutting Scissors

BC

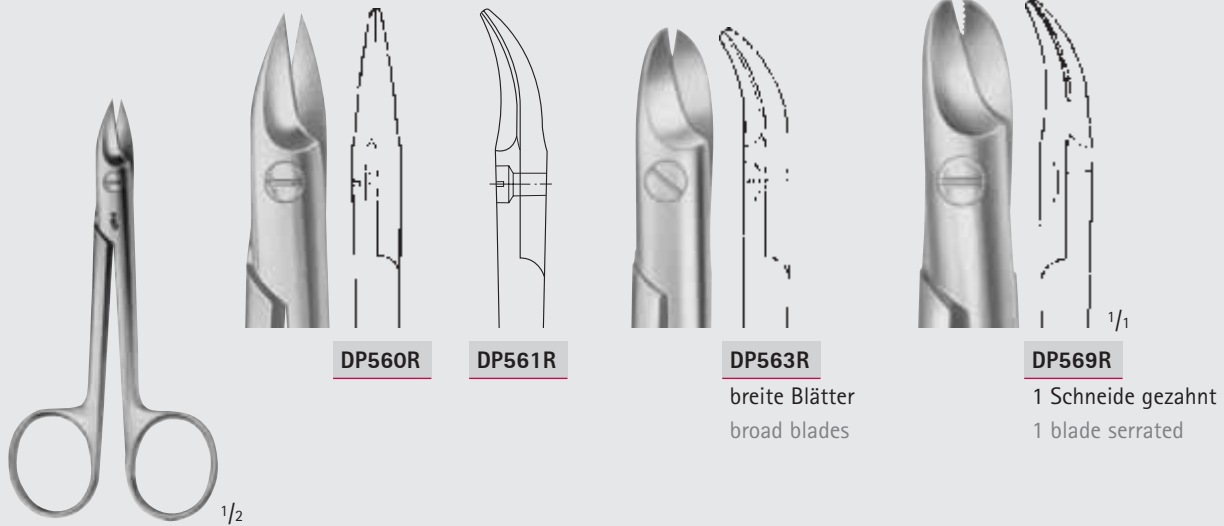

BEEBE

DP560R-DP569R

110 mm, 4 3/8"

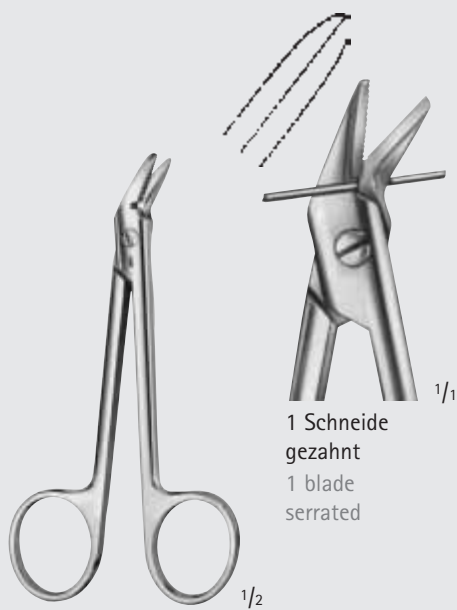

DP551R

120 mm, 4 3/4"

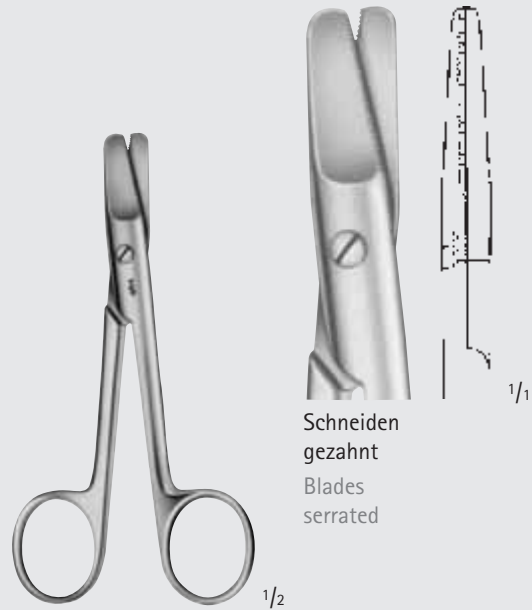

HARVEY

BC815R

125 mm, 5"



MILLIMETERS

Scheren – Scissors
 Nagelscheren
 Nail Scissors

BC



HF400R

Nagelschere
 Nail scissors
 90 mm, 3 1/2"

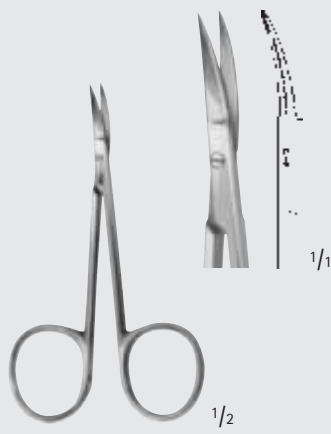

HF409R

Nagelschere,
 extra feines Modell
 Nail scissors,
 especially delicate pattern
 90 mm, 3 1/2"



HF032R

Baby-Nagelschere
 Baby nail scissors
 85 mm, 3 1/8"

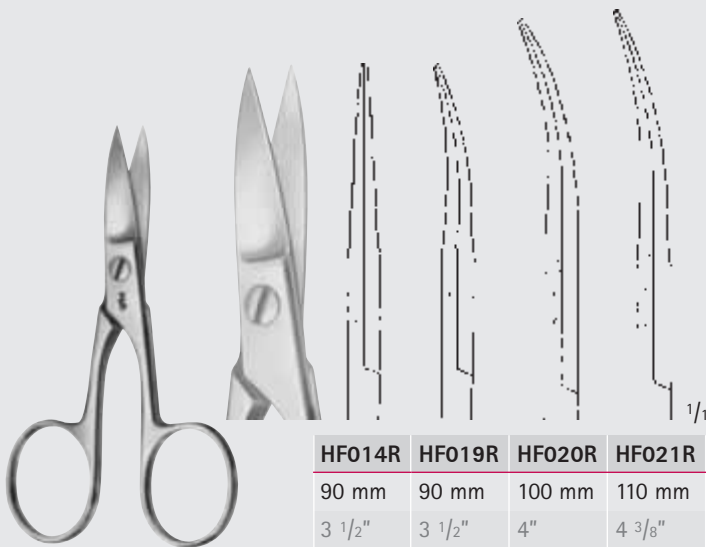

HF014R	HF019R	HF020R	HF021R
90 mm	90 mm	100 mm	110 mm
3 1/2"	3 1/2"	4"	4 3/8"

HF014R–HF021R

Nagelscheren
 Nail scissors



HF028R	HF030R	HF031R
95 mm	95 mm	105 mm
3 3/4"	3 3/4"	4 1/8"

HF028R–HF031R

Nagelscheren
 Nail scissors





Scheren – Scissors

Verbandstoff- und Verbandscheren

Bandage Scissors

BC

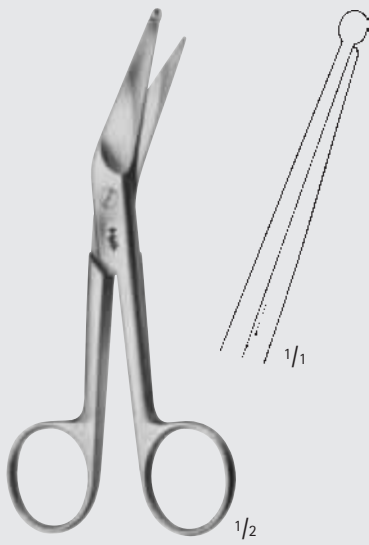

KNOWLES

BC847R

140 mm, 5 1/2"

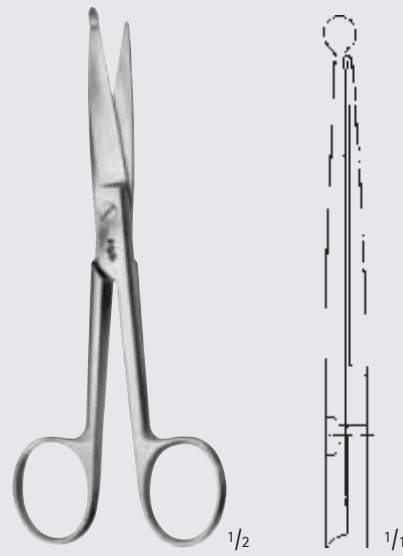

KNOWLES

BC846R

145 mm, 5 3/4"

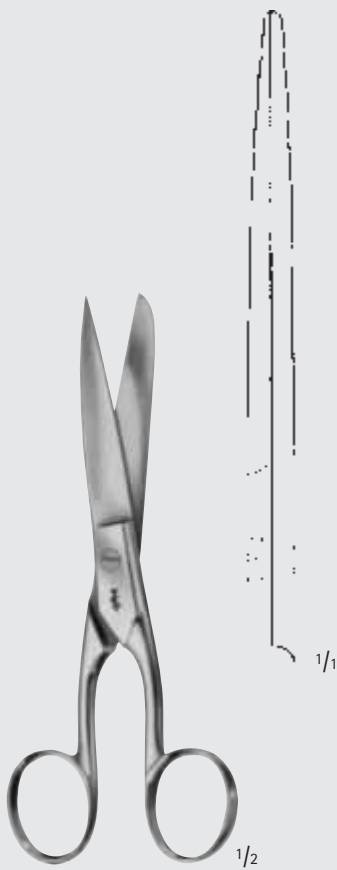

BC835R

150 mm, 6"

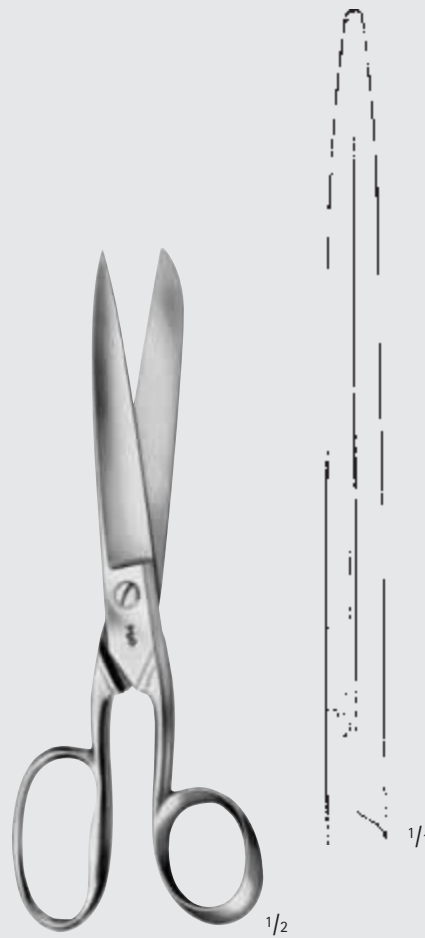

SMITH

BC838R

180 mm, 7"

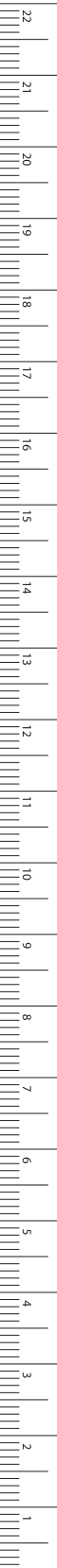

MILLIMETERS

Scheren – Scissors

Verband- und Kleiderscheren

Bandage- and Cloth Scissors

BC



LISTER

BC885R-BC979R

BC885R	schwarz	black	BC975R	orange	orange
BC970R	rot	red	BC977R	pink	pink
BC971R	blau	blue	BC978R	hellgrün	light green
BC973R	gelb	yellow	BC979R	violett	violet

Universal Verband- und Kleiderstoffschere, mit gezahnten Schneiden, autoklavierbar bis 143 °C (3 bar)

Universal bandage- and cloth scissors, with toothed edges, autoclavable up to 143 °C (3 bar)

145 mm, 5 3/4"



BC881R-BC989R

BC881R	schwarz	black	BC985R	orange	orange
BC980R	rot	red	BC987R	pink	pink
BC981R	blau	blue	BC988R	hellgrün	light green
BC983R	gelb	yellow	BC989R	violett	violet

Universal Verband- und Kleiderstoffschere, mit gezahnten Schneiden, autoklavierbar bis 143 °C (3 bar)

Universal bandage- and cloth scissors, with toothed edges, autoclavable up to 143 °C (3 bar)

180 mm, 7"

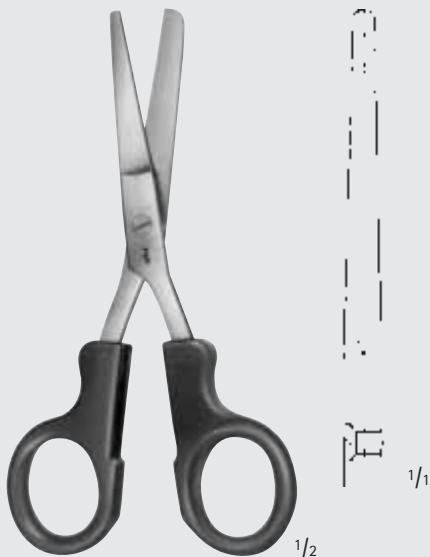

BC890R

Schwesternschere, autoklavierbar bis 143°C (3 bar)

Nurse's scissors, autoclavable up to 143°C (3 bar)

145 mm, 5 3/4"



Scheren – Scissors
 Verband- und Kleiderscheren
 Bandage- and Cloth Scissors

BC

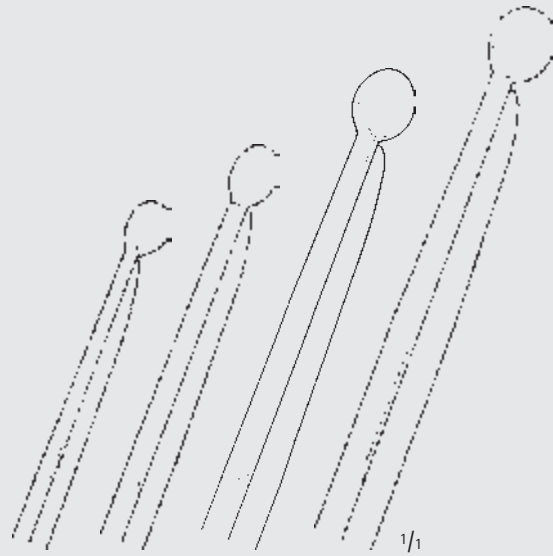

BC860R	BC861R	BC862R	BC863R
115 mm	140 mm	180 mm	200 mm
4 1/2"	5 1/2"	7"	8"

LISTER

BC860R-BC860R

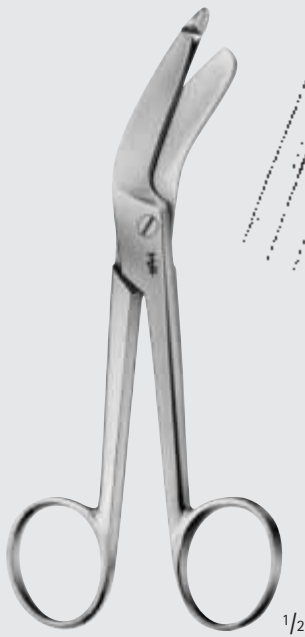

LISTER

BC876R

160 mm, 6 1/4"

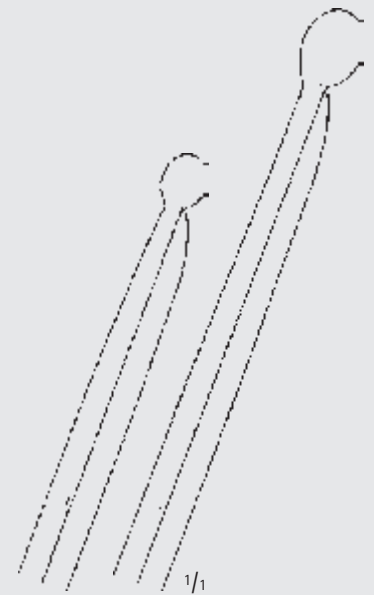

BC848R	BC849R
155 mm	180 mm
6"	7"

LISTER

BC848R-BC849R



MILLIMETERS

Scheren – Scissors

Verbands-, Kleider- und Gips-scheren
Bandage-, Cloth- and Plaster Scissors

BC

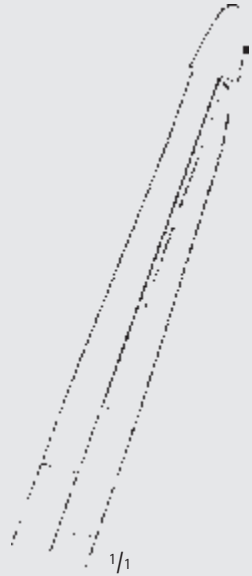

BC888R

Kleiderschere
Cloth scissors
205 mm, 8"

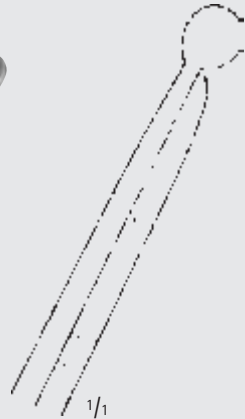

LX548R

für kleine Gipsverbände
for small plaster dressings
160 mm, 6 1/4"

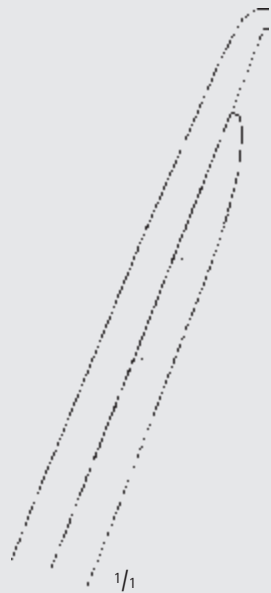

SEUTIN

LX565R

230 mm, 9"

INCHES



Scheren – Scissors
 Gipsscheren
 Plaster Scissors

BC

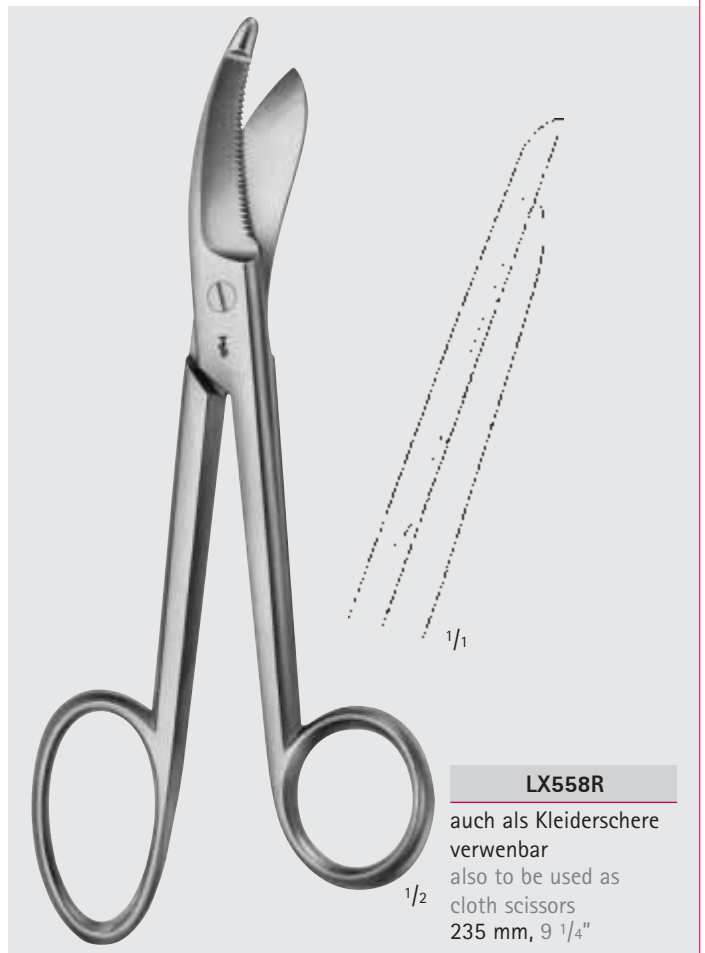
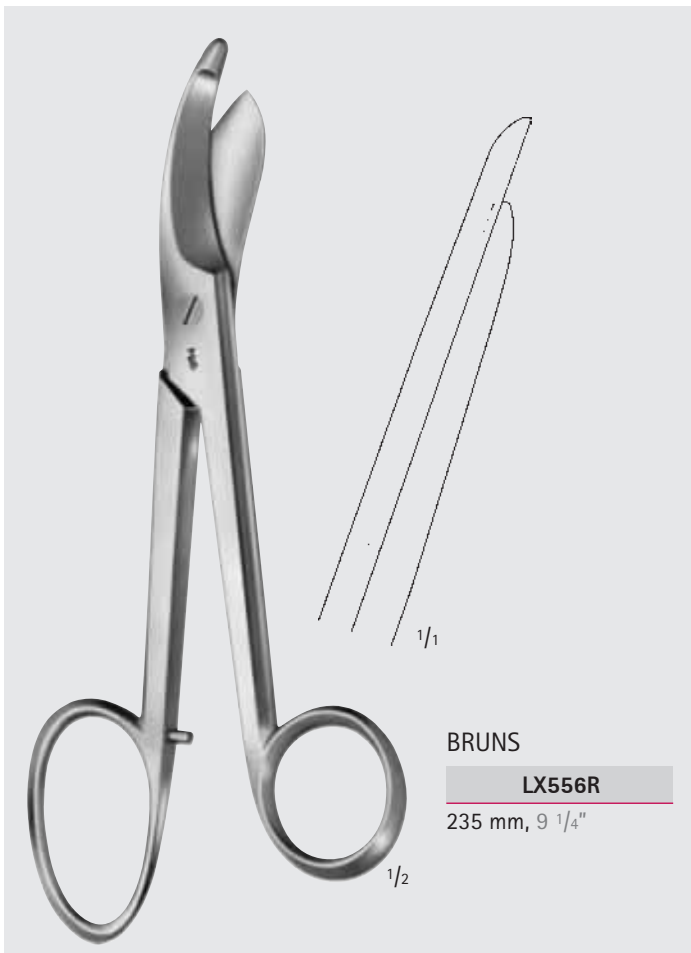
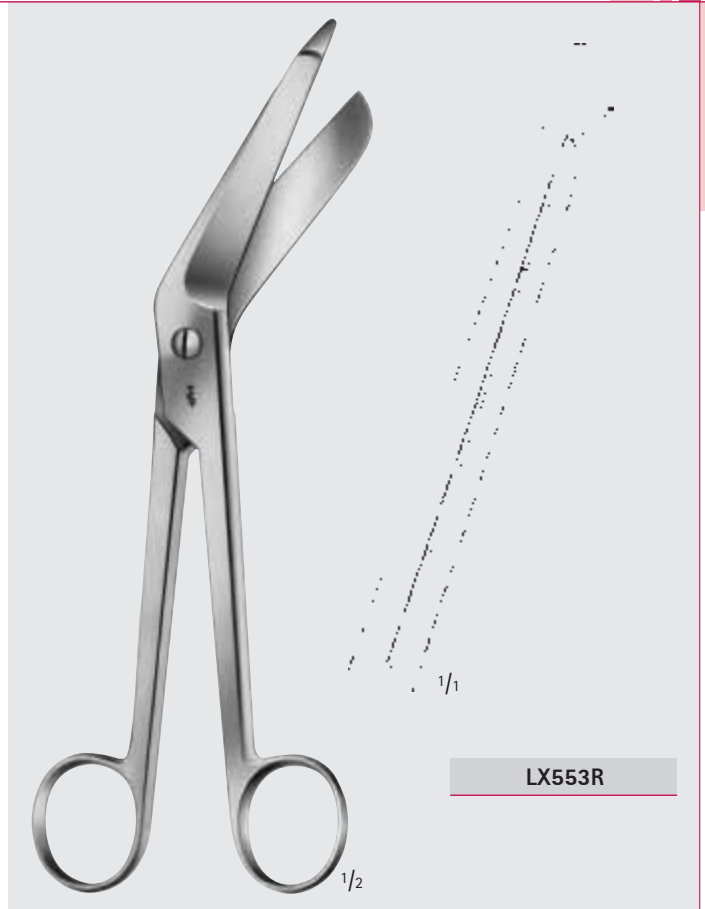
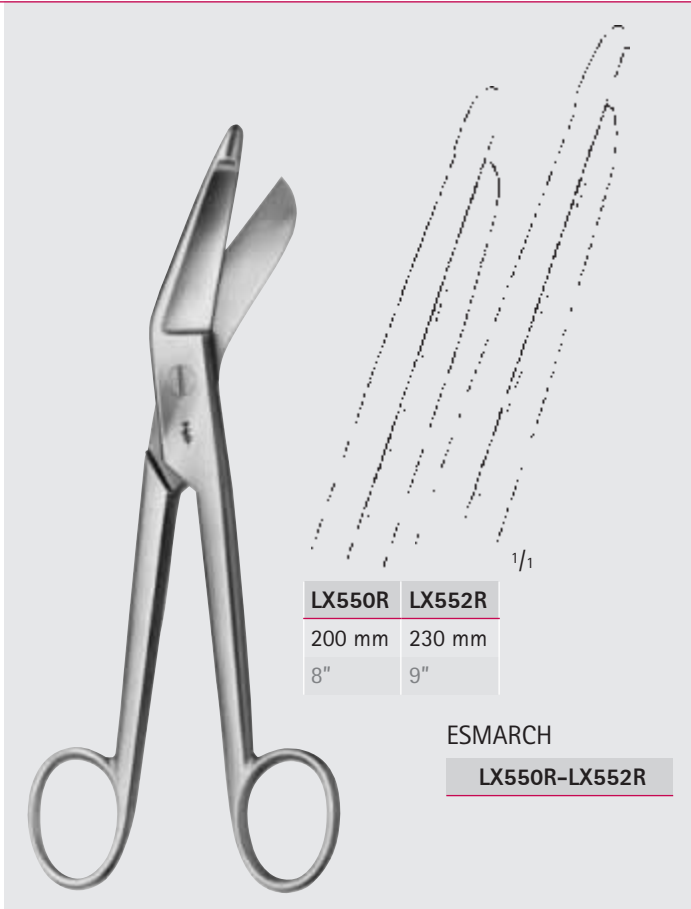

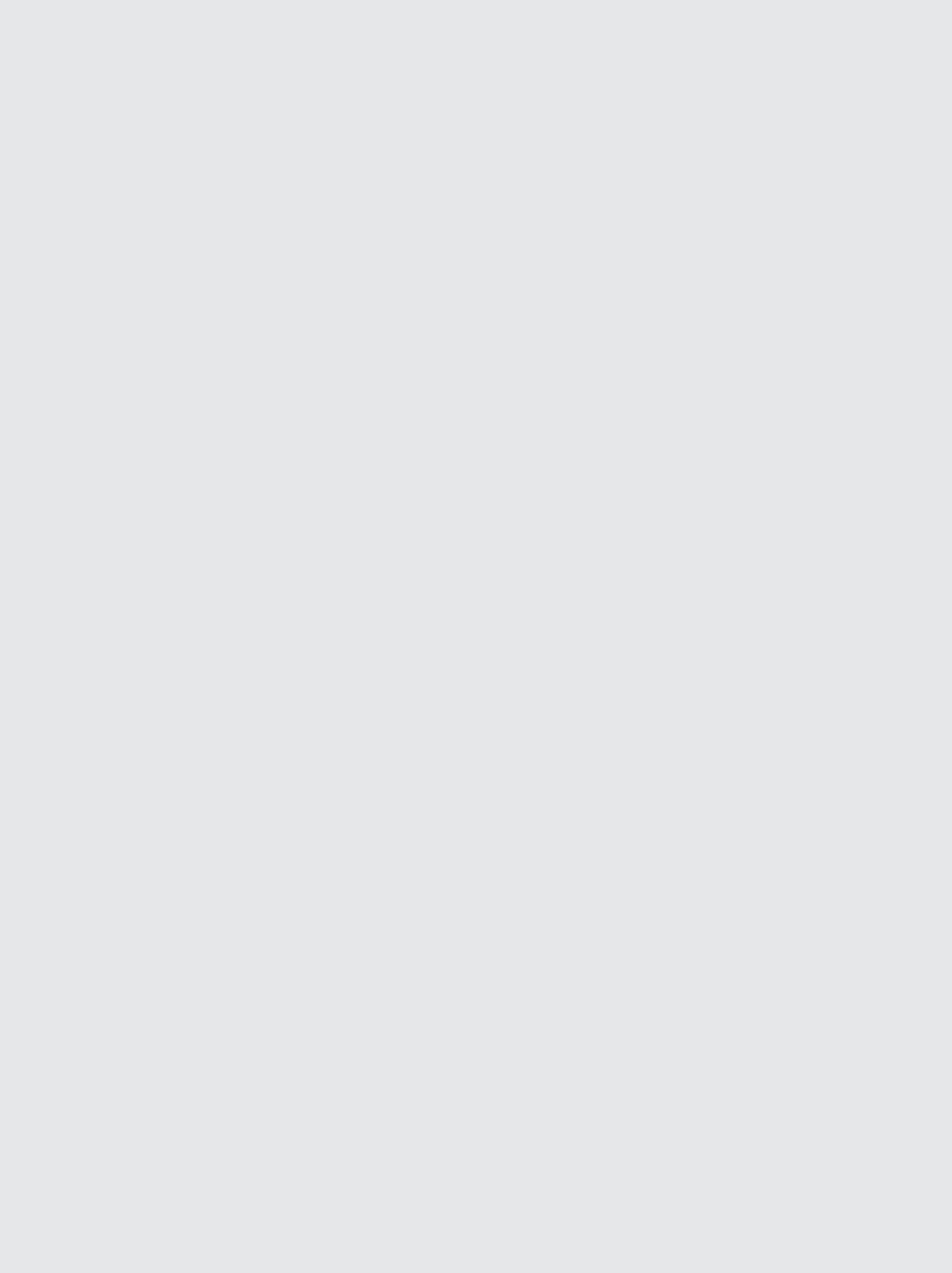

BD



Pinzetten

Dissecting- and Tissue Forceps

Pinzetten – Dissecting- and Tissue Forceps

Mikro-Pinzetten, Uhrmacher Modelle

Micro Forceps, Jeweler Patterns

BD

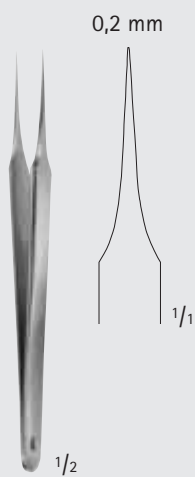

BD330R

110 mm, 4 3/8"

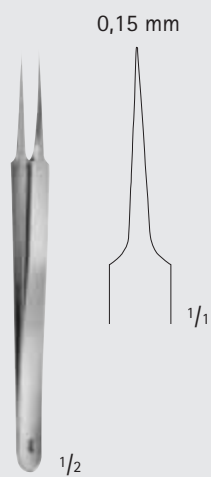

BD331R

110 mm, 4 3/8"

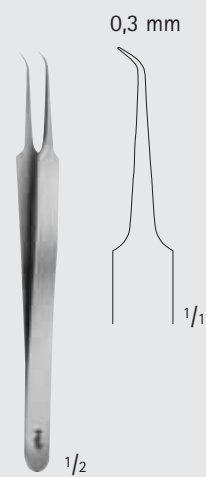

BD329R

110 mm, 4 3/8"

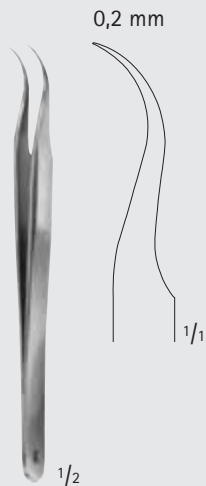

BD333R

115 mm, 4 1/2"



BD343R

115 mm, 4 1/2"

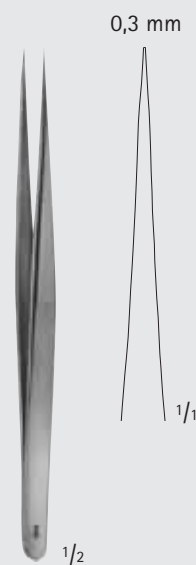

BD335R

135 mm, 5 1/4"

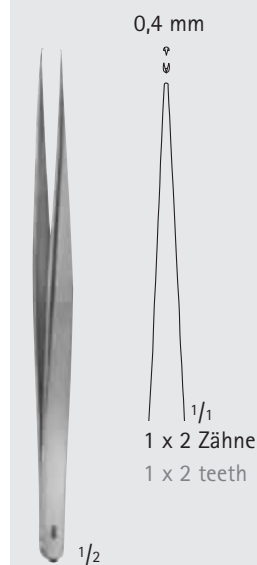

BD345R

135 mm, 5 1/4"



Pinzetten – Dissecting- and Tissue Forceps

Mikro-Knüpfpinzetten Mico Suture Tying Forceps

BD

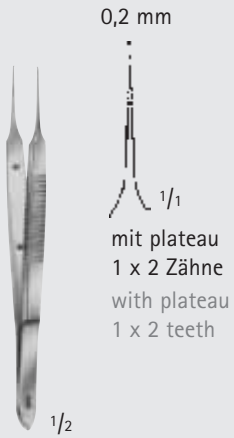
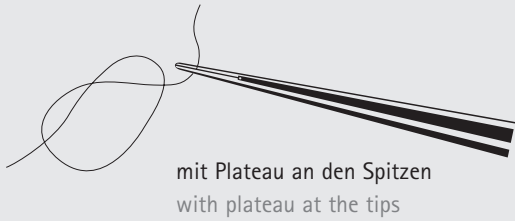

BONNER MODELL

BD505R

95 mm, 3 3/4"

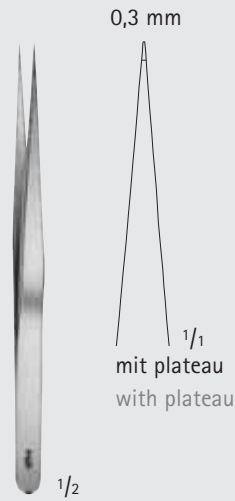

BD338R

120 mm, 4 3/4"

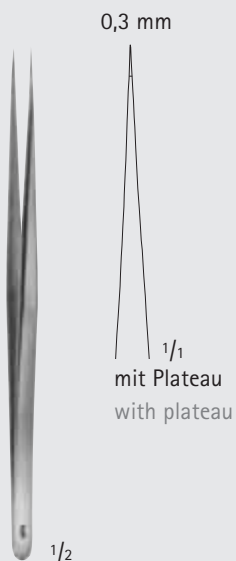

WISE

BD336R

135 mm, 5 1/4"

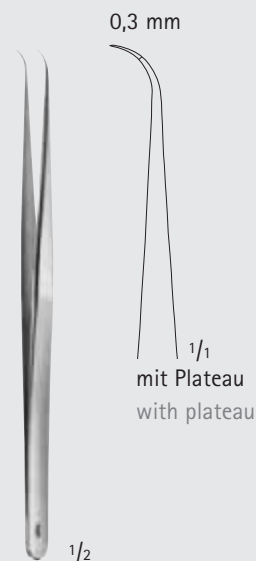

WISE

BD337R

135 mm, 5 1/4"

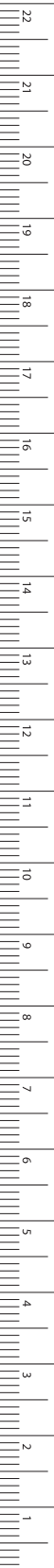

Pinzetten – Dissecting- and Tissue Forceps

Mikro-Knüpfpinzetten

Mico Suture Tying Forceps

BD

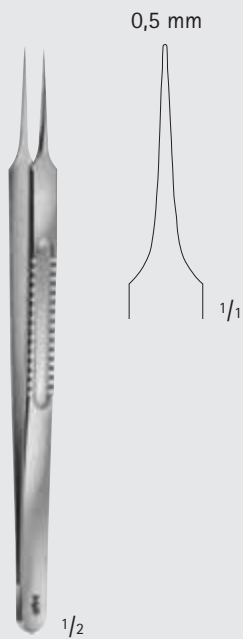

LAZAR

BD260R

155 mm, 6"

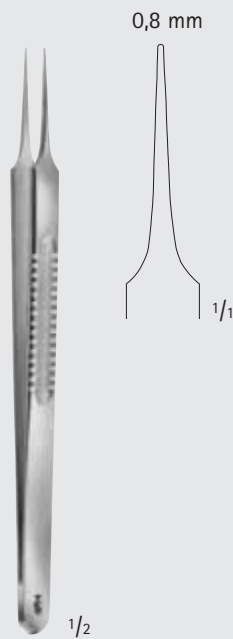

LAZAR

BD261R

155 mm, 6"

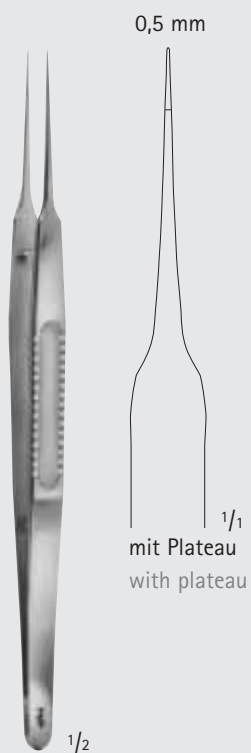

mit Plateau
with plateau

BD264R

185 mm, 7 1/4"

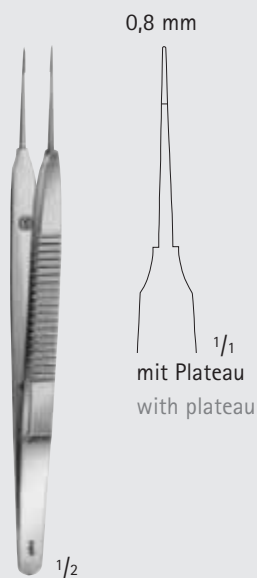

mit Plateau
with plateau

AUSTIN

BD340R

140 mm, 5 1/2"





Pinzetten – Dissecting- and Tissue Forceps

Mikro-Pinzetten mit leichtem Kunststoffgriffprofil

Micro Forceps with Lightweight Plastic Handle



Das MÜLLER Mikro-Instrumentarium

Ein neues, hochwertiges Set für die periphere Mikrochirurgie. Zahlreiche praxisbewährte Details führen zu mehr Effektivität und Sicherheit.

■ Unverkrampte Haltung = mehr Feingefühl

Das leichte Kunststoffprofil vergrößert die Griffoberfläche, gewährleistet dadurch eine unverkrampte Handhaltung und verleiht mehr Feingefühl.

■ Leichteres Drehen = erweiterter Arbeitsbereich

Der runde Griffquerschnitt ermöglicht leichtes, gleichmäßiges Drehen des Instrumentes. Verwendungs- bzw. Arbeitsbereich wird dadurch erweitert.

■ Sicherer Halt

Das griffige Noppenprofil gewährleistet einen durchweg sicheren Halt bei sämtlichen Bewegungsabläufen.

■ Optimales Handling

Eine Entwicklung nach ergonomischen Gesichtspunkten, verbunden mit dem geringen Gewicht der neuen Kunststoffgriffe schaffen die Voraussetzung zu ermüdungsfreiem Arbeiten und optimalem Handling.

The MÜLLER Micro instrument system

A top quality set for peripheral microsurgery. Numerous details tried and tested in practice mean increased efficiency and safety.

■ Natural holding position = increased sensitivity

The light plastic profile increases the grip surface, thus guaranteeing a natural hand position without cramping and providing enhanced sensitivity.

■ Easier rotation = extended working area

The round grip cross section permits easy and uniform rotation of the instrument. This extends the application and working areas.

■ Safe grip

The easy grip studded profile guarantees a secure hold for all movements.

■ Optimum handling

Development in accordance with ergonomic criteria and the low weight of the new plastic grips provide fatiguefree working and optimum handling.

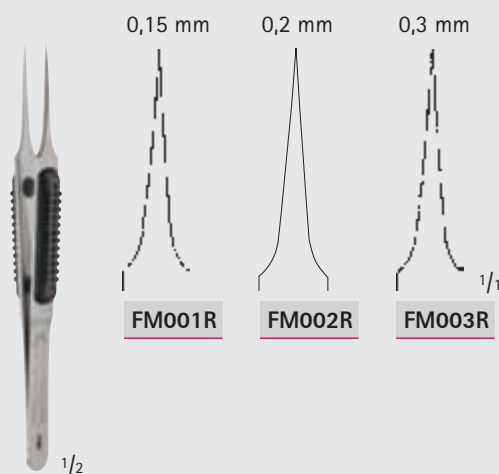

MÜLLER

FM001R-FM003R

110 mm, 4 3/8"

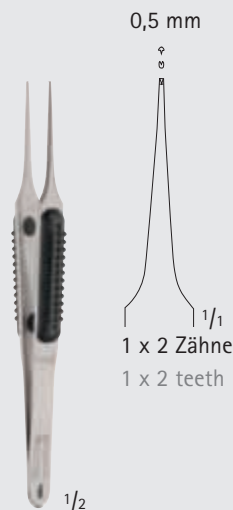

MÜLLER

FM004R

110 mm, 4 3/8"

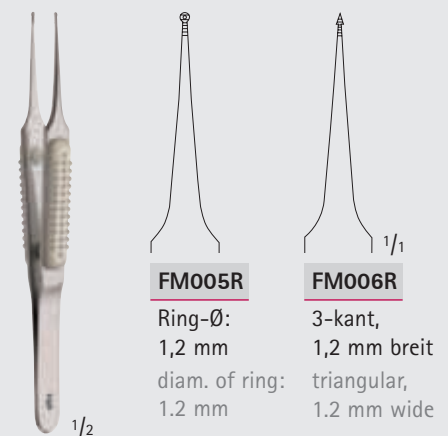

MÜLLER

FM005R-FM006R

110 mm, 4 3/8"

BD

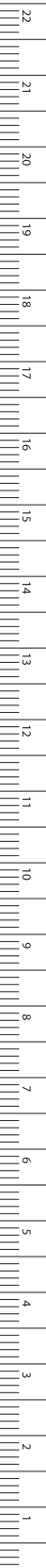

MILLIMETERS

Pinzetten – Dissecting- and Tissue Forceps

Mikro-Pinzetten mit leichtem Kunststoffgriffprofil

Micro Forceps with Lightweight Plastic Handle

BD



0,3 mm

FM033R

0,4 mm

FM036R

mit Plateau
with plateau

MÜLLER

FM033R-FM036R

160 mm, 6 1/4"



0,5 mm



1 x 2 Zähne
1 x 2 teeth

MÜLLER

FM034R

160 mm, 6 1/4"



Ring-Ø
1,2 mm
diam. of ring
1.2 mm

MÜLLER

FM035R

160 mm, 6 1/4"



Pinzetten – Dissecting- and Tissue Forceps

Mikro-Knüpfpinzetten mit Rundgriffen

Micro Suture Tying Forceps with Round Handle

... mit Rundgriffen

- Rundgriffe erlauben Drehbewegungen zwischen den Fingern.
- Optimale Balance, individuell je nach Instrument, durch volle oder gehöhlte Griffpartien.

... with round handles

- Round handles allow turning manipulations between the fingers.
- Optimum balance individually for each instrument due to solid or hollowed-out handles.

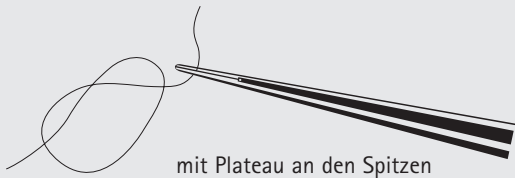

mit Plateau an den Spitzen
with plateau at the tips

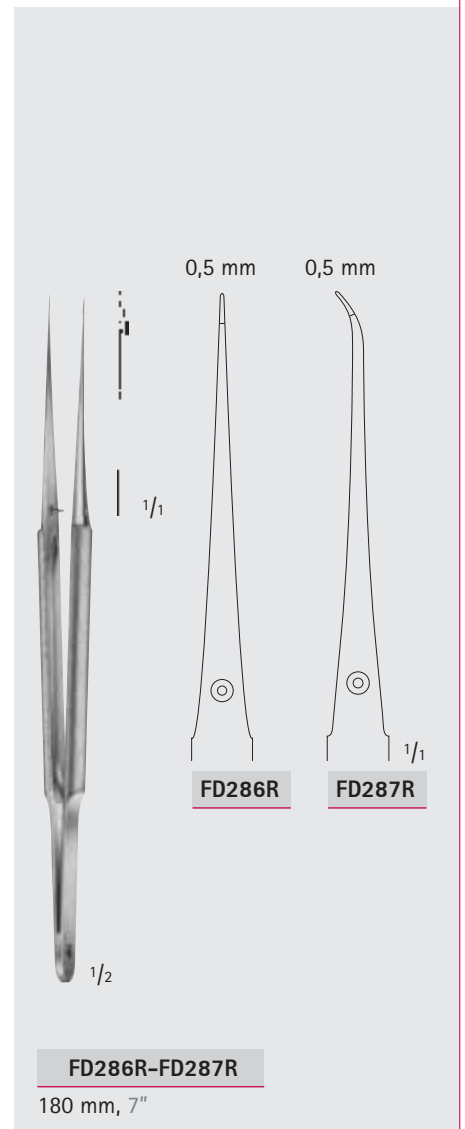
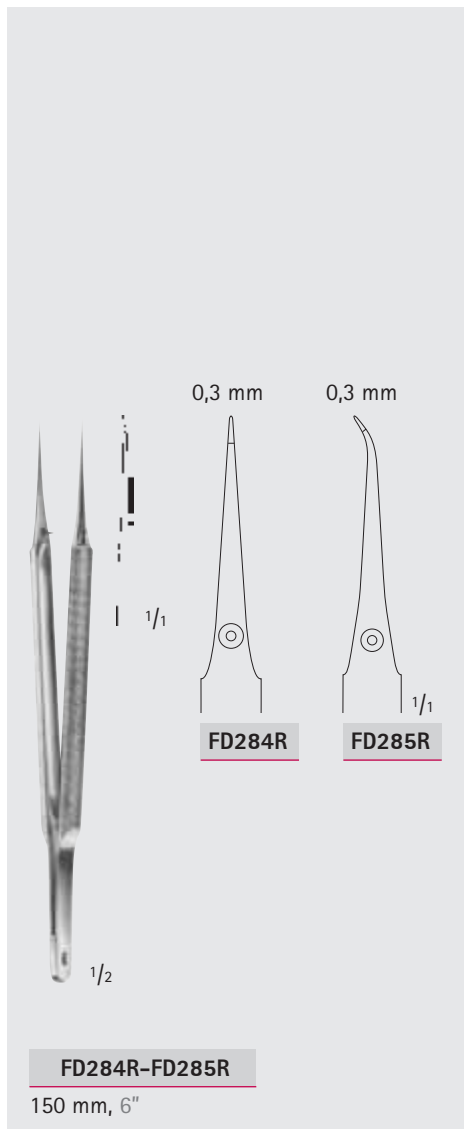
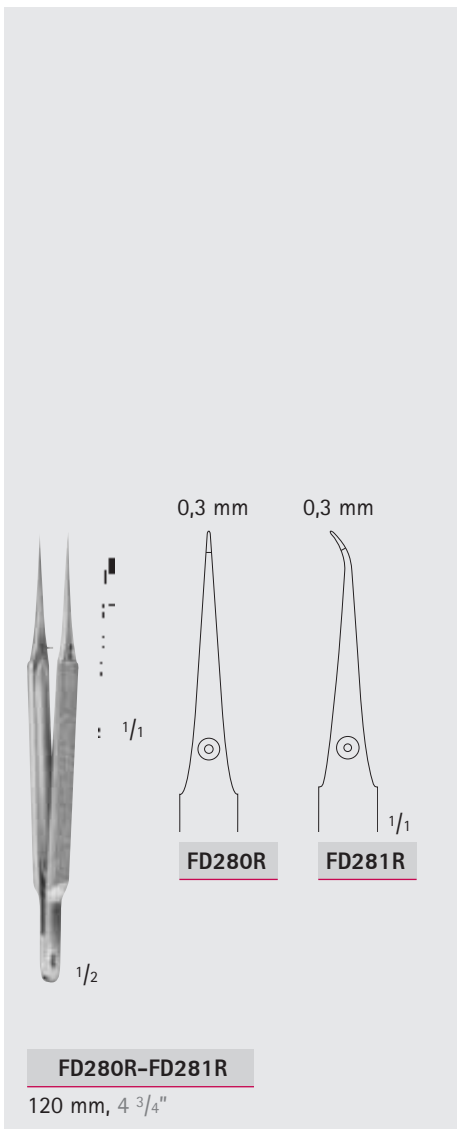

BD

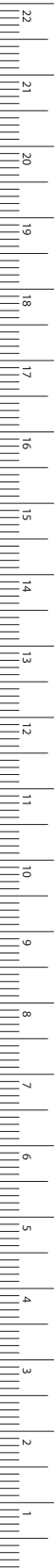

MILLIMETERS

Pinzetten – Dissecting- and Tissue Forceps

Mikro-Pinzetten mit Rundgriff und Gewicht

Micro Forceps with Round Handles and Counter Balance

BD

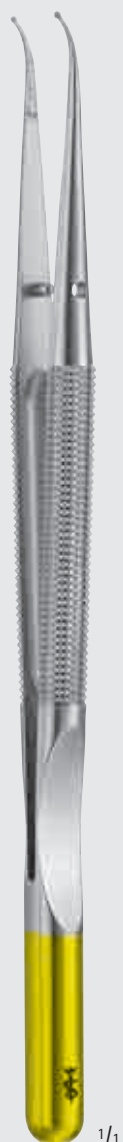

150 mm, 6" $\frac{1}{1}$

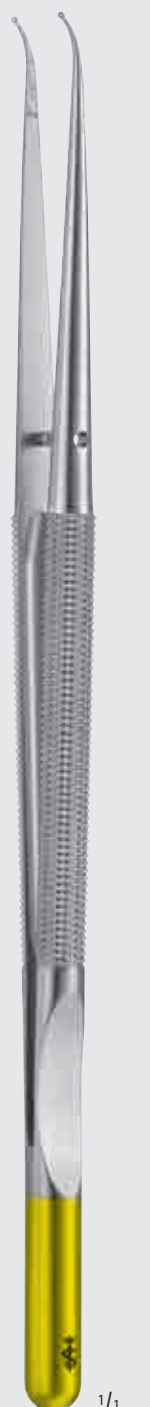

185 mm, 7 $\frac{1}{4}$ " $\frac{1}{1}$

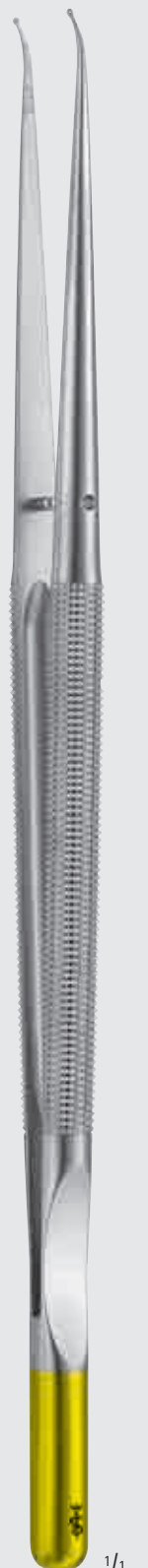

210 mm, 8 $\frac{1}{4}$ " $\frac{1}{1}$



230 mm, 9" $\frac{1}{1}$



250 mm, 10" $\frac{1}{1}$



Pinzetten – Dissecting- and Tissue Forceps

Mikro-Pinzetten mit Rundgriff und Gewicht

Micro Forceps with Round Handles and Counter Balance

BD



DIADUST



Die Diamantstaubbeschichtung sorgt für eine noch härtere und verschleißfestere Maulinnenfläche. Darüber hinaus garantiert die Struktur der DIADUST-Beschichtung ein zuverlässiges Fassen von feinen Nadeln und Nahtmaterialien sowie von Weichgewebe.

The diamond dust coating ensures an even harder and more wear resistant surface on the inside of the jaws. Moreover, the structure of the DIADUST coating guarantees a reliable grip for fine needles and sutures, as well as for tissue.

Maulform
Jaw

Ring-Ø:
1 mm,
gerade
diam. of ring:
1 mm,
straight



Ring-Ø:
1 mm,
gebogen
diam. of ring:
1 mm,
curved



Ring-Ø:
2 mm,
gerade
diam. of ring:
2 mm,
straight



Fadenplatte,
gerade
Platform tips,
straight



Fadenplatte,
gebogen
Platform tips,
curved



1 mm,
DeBakey
Zahnung
1 mm,
DeBakey tip



Länge (mm)
Length (in.)

150 mm
6"

[FM570R](#)

[FM571R](#)

[FM578R](#)

[FM581R](#)

185 mm
7 1/4"

[FM572R](#)

[FM573R](#)

[FM579R](#)

[FM580R](#)

[FM583R](#)

[FM592R](#)

210 mm
8 1/4"

[FM574R](#)

[FM575R](#)

[FM599R](#)

[FM585R](#)

[FM600R](#)

230 mm
9"

[FM576R](#)

[FM577R](#)

250 mm
10"

[FM596R](#)

[FM595R](#)

[FM594R](#)

[FM593R](#)

MILLIMETERS

Pinzetten – Dissecting- and Tissue Forceps

Mikro-Pinzetten mit Rundgriff, ohne Gewicht

Micro Forceps with Round Handles, without Counter Balance

BD



$\frac{1}{1}$
185 mm, 7 $\frac{1}{4}$ "

$\frac{1}{1}$
210 mm, 8 $\frac{1}{4}$ "



Pinzetten – Dissecting- and Tissue Forceps

Mikro-Pinzetten mit Rundgriff, ohne Gewicht

Micro Forceps with Round Handles, without Counter Balance

BD



DIADUST



Die Diamantstaubbeschichtung sorgt für eine noch härtere und verschleißfestere Maulinnenfläche. Darüber hinaus garantiert die Struktur der DIADUST-Beschichtung ein zuverlässiges Fassen von feinen Nadeln und Nahtmaterialien sowie von Weichgewebe.

The diamond dust coating ensures an even harder and more wear resistant surface on the inside of the jaws. Moreover, the structure of the DIADUST coating guarantees a reliable grip for fine needles and sutures, as well as for tissue.

Maulform
Jaw

Ring-Ø:
1 mm,
gerade
diam. of ring:
1 mm,
straight



Ring-Ø:
1 mm,
gebogen
diam. of ring:
1 mm,
curved



Ring-Ø:
1 mm mit
Fadenplatte
diam. of ring:
1 mm with
platform tip



Fadenplatte,
gerade
Platform tip,
straight



1 mm,
DeBakey
Zahnung
1 mm,
DeBakey tip



Länge (mm)
Length (in.)

185 mm
7 1/4"

FM597R

FM587R

FM582R

FM586R

FM590R

210 mm
8 1/4"

FM598R

FM589R

FM584R

FM588R

FM591R

MILLIMETERS

Pinzetten – Dissecting- and Tissue Forceps

Mikro-Pinzetten mit Flachgriff

Micro Forceps with Flat Handle

BD



180 mm, 7" $\frac{1}{1}$



200 mm, 8" $\frac{1}{1}$



250 mm, 10" $\frac{1}{1}$



Pinzetten – Dissecting- and Tissue Forceps

Mikro-Pinzetten mit Flachgriff

Micro Forceps with Flat Handle

BD



MILLIMETERS

DIADUST



Die Diamantstaubbeschichtung sorgt für eine noch härtere und verschleißfestere Maulinnenfläche. Darüber hinaus garantiert die Struktur der DIADUST-Beschichtung ein zuverlässiges Fassen von feinen Nadeln und Nahtmaterialien sowie von Weichgewebe.

The diamond dust coating ensures an even harder and more wear resistant surface on the inside of the jaws. Moreover, the structure of the DIADUST coating guarantees a reliable grip for fine needles and sutures, as well as for tissue.

Maulform
Jaw

1 mm,
Karoprofil

1 mm,
cross serrated



1 mm,
DeBakey
Zahnung

1 mm,
DeBakey tip



Ring-Ø:
1 mm,
gerade

diam. of ring:
1 mm,
straight



Ring-Ø:
1 mm,
gebogen

diam. of ring:
1 mm,
curved



1 mm,
gerade

1 mm,
straight



Länge (mm)
Length (in.)

180 mm
7"

BD190R

BD191R

BD192R

BD193R

BD194R

200 mm
8"

BD195R

BD196R

250 mm
10"

BD197R

1/1

Pinzetten – Dissecting- and Tissue Forceps

Mikro-Pinzetten

Micro Forceps

BD



1/1
Karoprofil
cross serrated

1/2

FM063R

Rundgriff
round handle
200 mm, 8"



FM053R

Ring-Ø: 2,5 mm
diam. of ring: 2.5 mm

180 mm

7"



FM054R

Ring-Ø: 2,5 mm
diam. of ring: 2.5 mm

200 mm

8"

FM053R-FM054R

Rundgriff
round handle



1/1
mit Plateau
with platform tip

1/2

FD253R

Rundgriff
round handle
180 mm, 7"



Pinzetten – Dissecting- and Tissue Forceps

Feine anatomische Pinzetten
Delicate Dissecting Forceps

BD

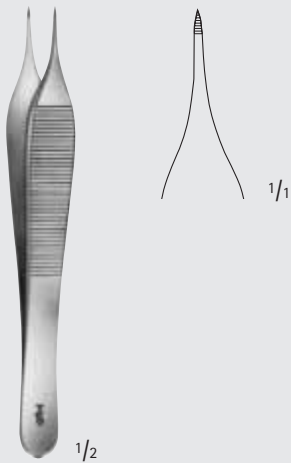

THORPE

OC069R

Hornhautpinzette
Corneal forceps
120 mm, 4 3/4"

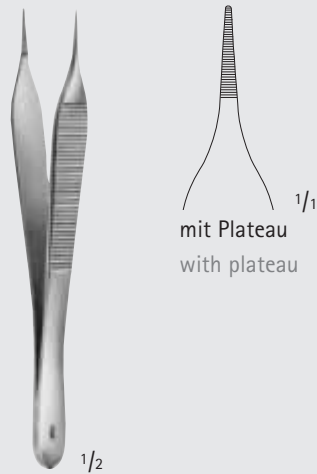

MICRO-ADSON

BD220R

120 mm, 4 3/4"

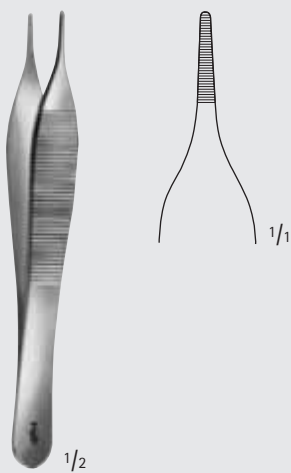

ADSON

BD222R

120 mm, 4 3/4"



HUDSON

BD225R

125 mm, 5"

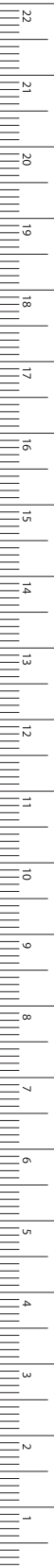

MILLIMETERS

Pinzetten – Dissecting- and Tissue Forceps

Feine anatomische Pinzetten

Delicate Dissecting Forceps

BD

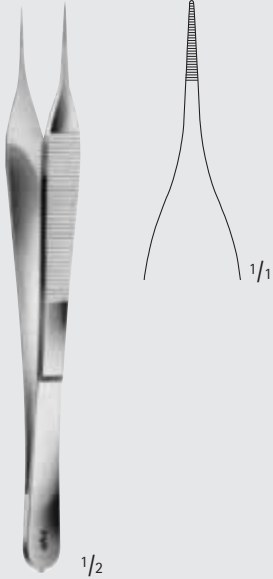

MICRO-ADSON

BD223R

150 mm, 6"

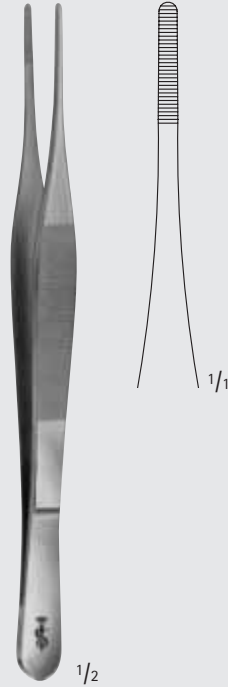

ADSON

BD224R

180 mm, 7"

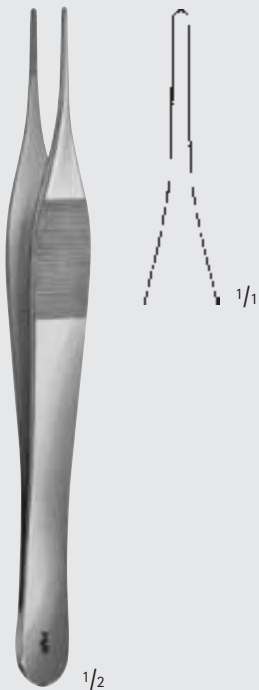

JEFFERSON

BD226R

180 mm, 7"

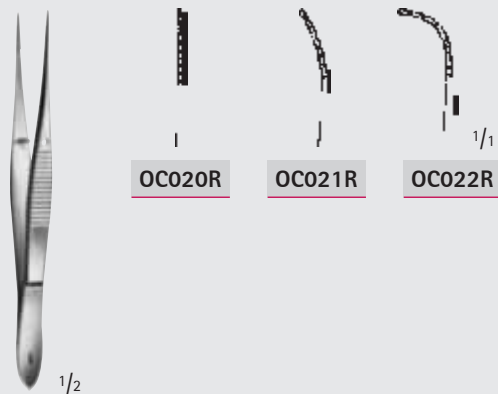

OC020R

OC021R

OC022R

OC020R-OC022R

100 mm, 4"



Pinzetten – Dissecting- and Tissue Forceps

Feine anatomische Pinzetten
Delicate Dissecting Forceps

BD

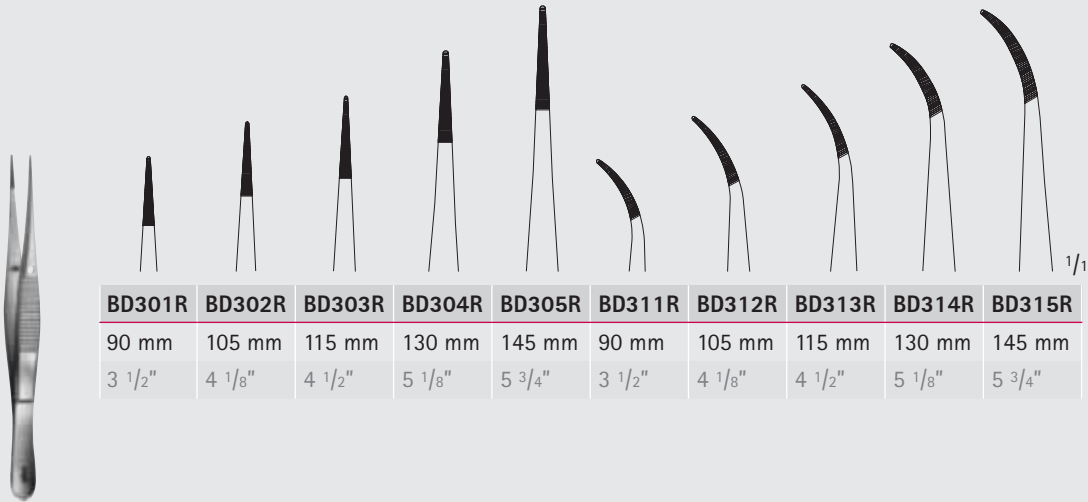

BD301R	BD302R	BD303R	BD304R	BD305R	BD311R	BD312R	BD313R	BD314R	BD315R
90 mm	105 mm	115 mm	130 mm	145 mm	90 mm	105 mm	115 mm	130 mm	145 mm
3 1/2"	4 1/8"	4 1/2"	5 1/8"	5 3/4"	3 1/2"	4 1/8"	4 1/2"	5 1/8"	5 3/4"

BD301R-BD315R

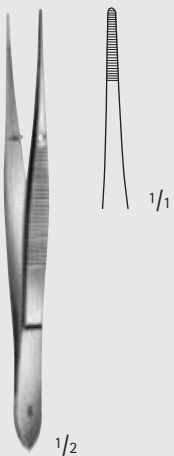

BD210R
115 mm, 4 1/2"



BD320R
100 mm, 4"

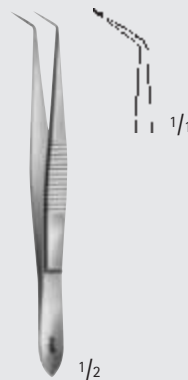

BD321R
100 mm, 4"

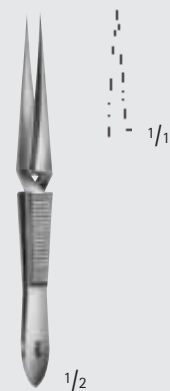

BD322R
100 mm, 4"



MILLIMETERS

Pinzetten – Dissecting- and Tissue Forceps

Feine anatomische Pinzetten

Delicate Dissecting Forceps

BD

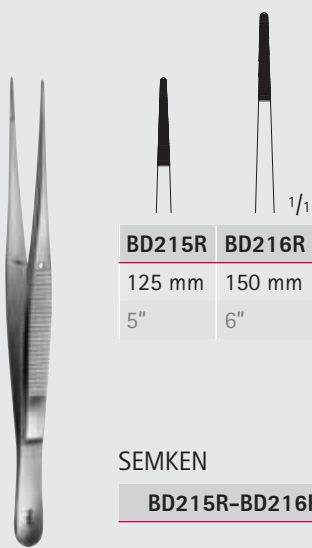

SEMKEN

BD215R-BD216R



BD217R



GILLIES

BD213R



MC INDOE

BD236R

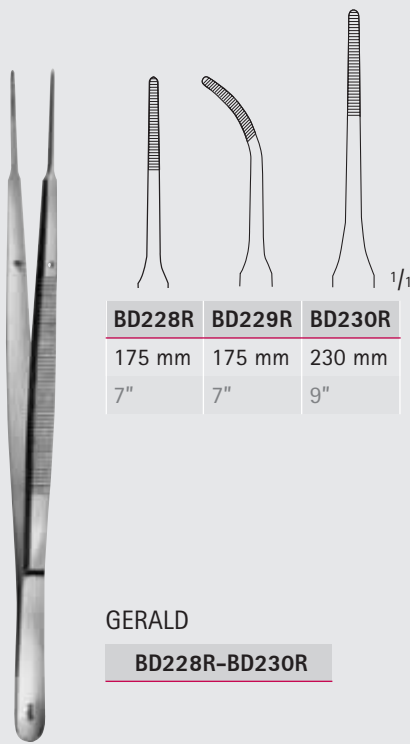

GERALD

BD228R-BD230R



CAIRNS-DOTT

BD268R-BD269R





Pinzetten – Dissecting- and Tissue Forceps

Feine Anatomische Pinzetten

Delicate Dissecting Forceps

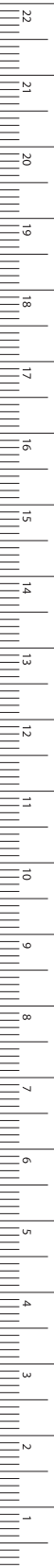
BD

BD238R	BD239R	BD243R	BD240R
180 mm	200 mm	200 mm	250 mm
7"	8"	8"	10"

CUSHING

BD238R-BD243R

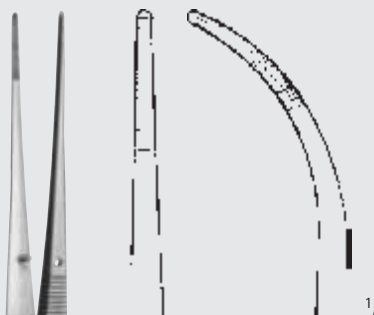

BD246R **BD247R**

BROPHY

BD246R-BD247R

1/2 200 mm, 8"



BD081R

1/2 200 mm, 8"

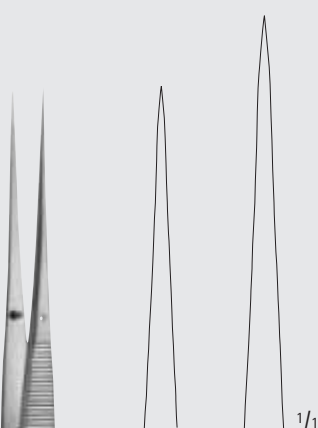

BD231R	BD232R
185 mm	200 mm
7 1/4"	8"

BD231R-BD232R

glattes Maul
smooth jaws

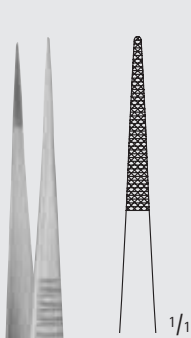

BD250R

COOLEY

BD250R

1/2 200 mm, 8"

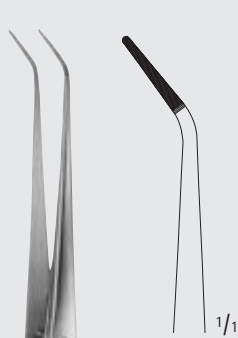

BD257R

1/2 200 mm, 8"

Pinzetten – Dissecting- and Tissue Forceps

Anatomische Pinzetten

Dissecting Forceps

BD

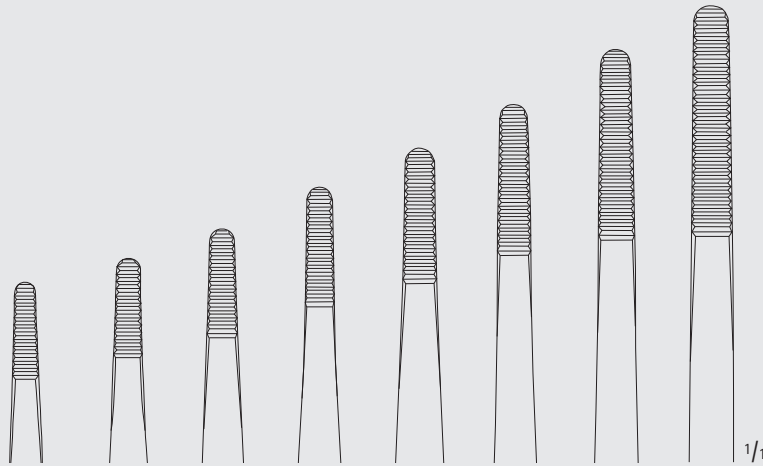

BD043R	BD045R	BD047R	BD049R	BD050R	BD051R	BD052R	BD053R
115 mm	130 mm	145 mm	160 mm	180 mm	200 mm	250 mm	300 mm
4 1/2"	5 1/8"	5 3/4"	6 1/4"	7"	8"	10"	12"

BD043R-BD053R

Standard-Modelle

Standard patterns

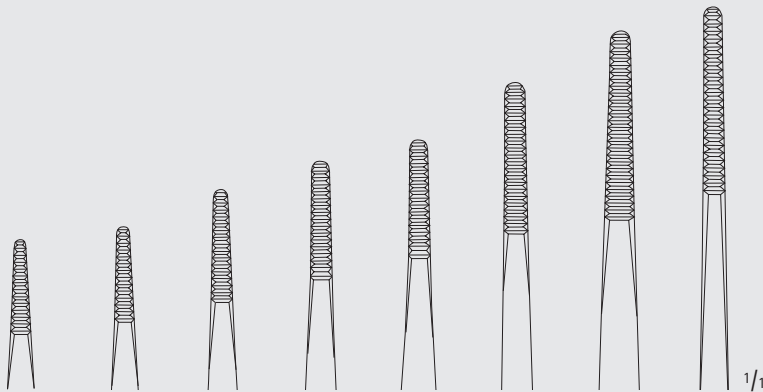

BD023R	BD025R	BD027R	BD029R	BD030R	BD031R	BD032R	BD033R
115 mm	130 mm	145 mm	160 mm	180 mm	200 mm	250 mm	305 mm
4 1/2"	5 1/8"	5 3/4"	6 1/4"	7"	8"	10"	12"

BD023R-BD033R

mittelbreit

medium



Pinzetten – Dissecting- and Tissue Forceps

Anatomische Pinzetten
Dissecting Forceps

BD

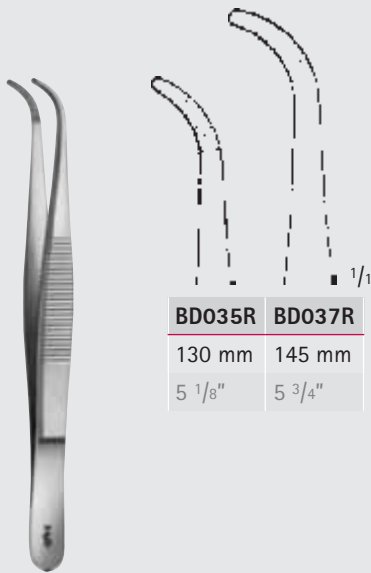

BD035R	BD037R
130 mm	145 mm
5 1/8"	5 3/4"

BD035R-BD037R

mittelbreit
medium

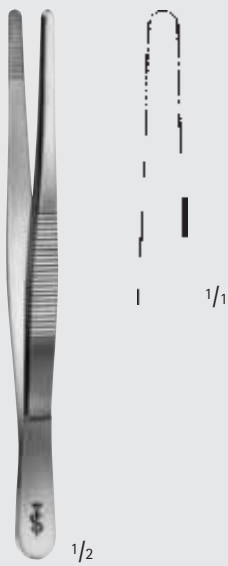

BD077R

extra breit
extra large
145 mm, 5 3/4"

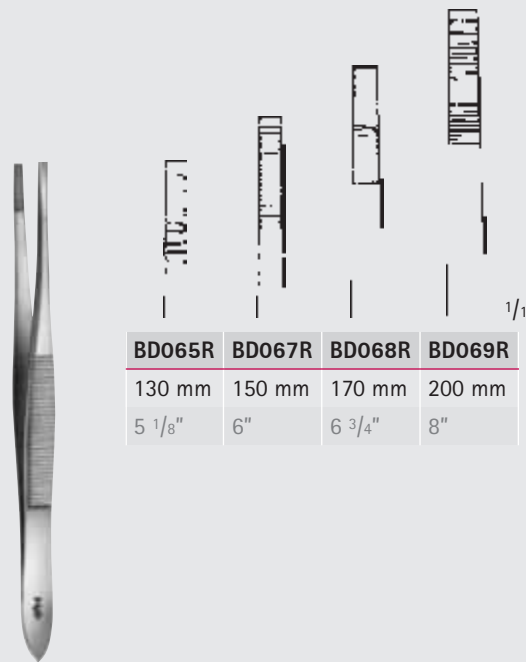

BD065R	BD067R	BD068R	BD069R
130 mm	150 mm	170 mm	200 mm
5 1/8"	6"	6 3/4"	8"

SCHWEDISCHES MODELL

BD065R-BD069R



Pinzetten – Dissecting- and Tissue Forceps

Anatomische Pinzetten

Dissecting Forceps

BD



OCHSNER

BD130R

Fadenpinzette

Ligature forceps

145 mm, 5 3/4"



BONNEY

BD078R

175 mm, 7"

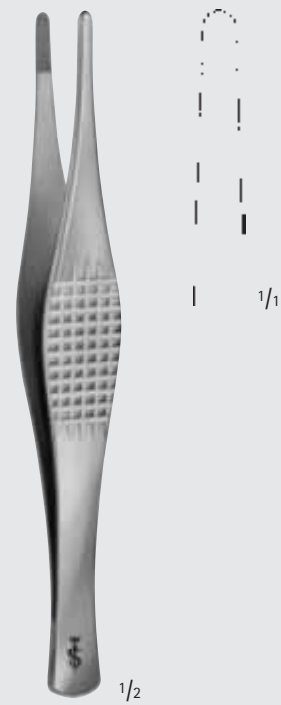

RAMSEY

BD083R

180 mm, 7"



DE BAKEY Zahnung

Toothing DE BAKEY

AIRAUMATA®

Pinzetten – Dissecting- and Tissue Forceps

Ultra-Light-Pinzetten

Ultra-Light-Forceps

BD

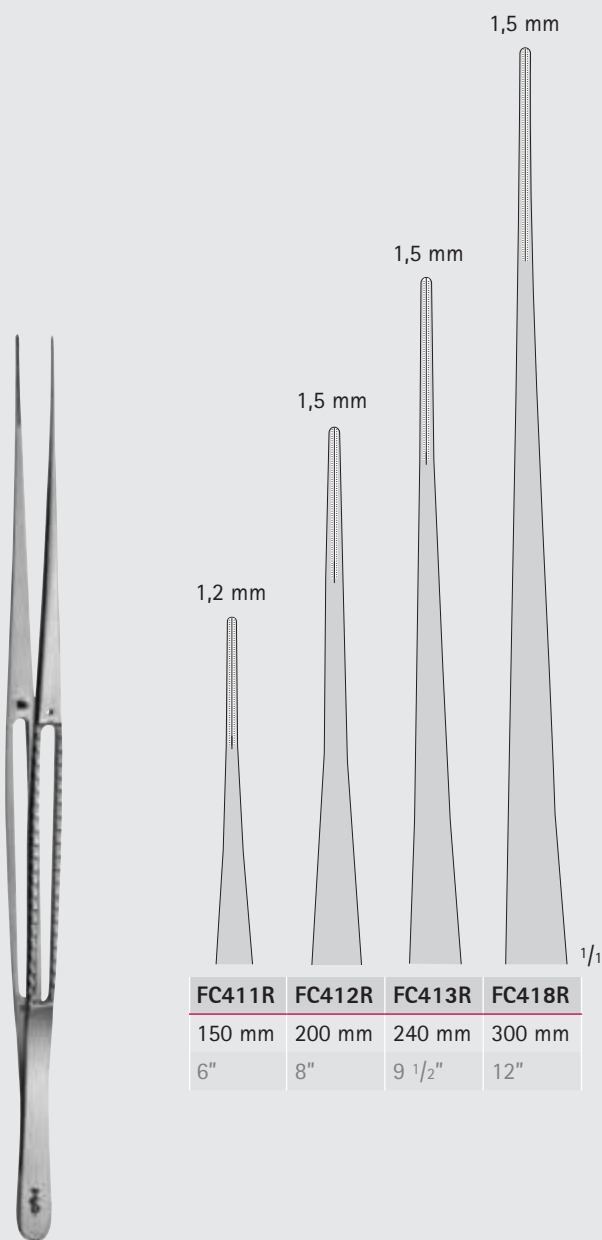

FC411R	FC412R	FC413R	FC418R
150 mm	200 mm	240 mm	300 mm
6"	8"	9 1/2"	12"

DE BAKEY

FC411R-FC418R



MILLIMETERS

Pinzetten – Dissecting- and Tissue Forceps

Pinzetten
Forceps

DE BAKEY Zahnung

ARAUMATA®

Toothing DE BAKEY

BD

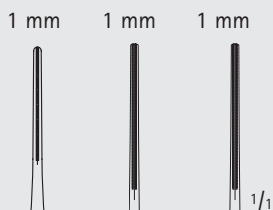

FB394R	FB395R	FB396R
150 mm	195 mm	240 mm
6"	7 3/4"	9 1/2"

DE BAKEY

FB394R-FB396R

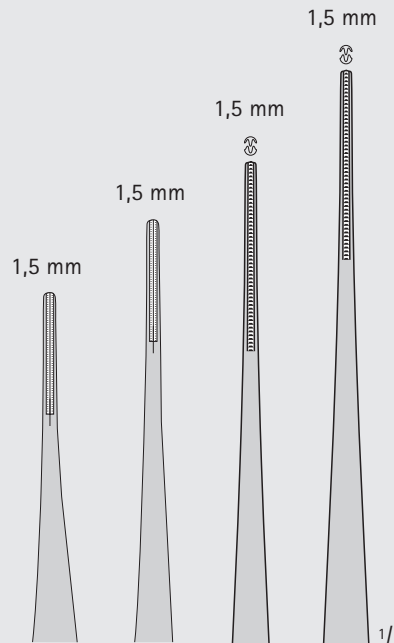

FB411R	FB412R	FB418R	FB419R
150 mm	200 mm	240 mm	300 mm
6"	8"	9 1/2"	12"

DE BAKEY

FB411R-FB419R

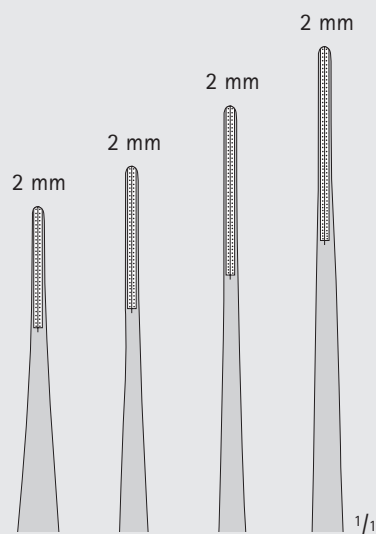

FB400R	FB402R	FB404R	FB405R
150 mm	200 mm	240 mm	300 mm
6"	8"	9 1/2"	12"

DE BAKEY

FB400R-FB405R

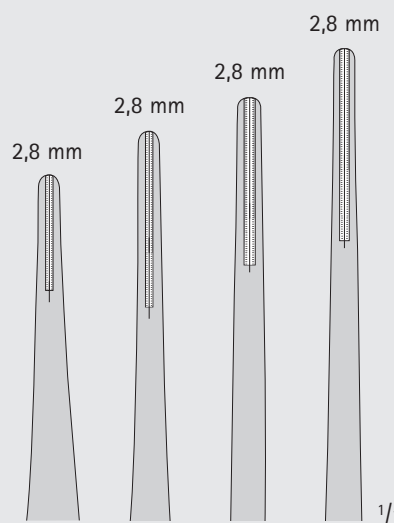

FB414R	FB415R	FB416R	FB417R
150 mm	200 mm	240 mm	300 mm
6"	8"	9 1/2"	12"

DE BAKEY

FB414R-FB417R



DE BAKEY Zahnung

Toothing DE BAKEY

AIRAUMATA®

Pinzetten – Dissecting- and Tissue Forceps

Pinzetten
Forceps

BD

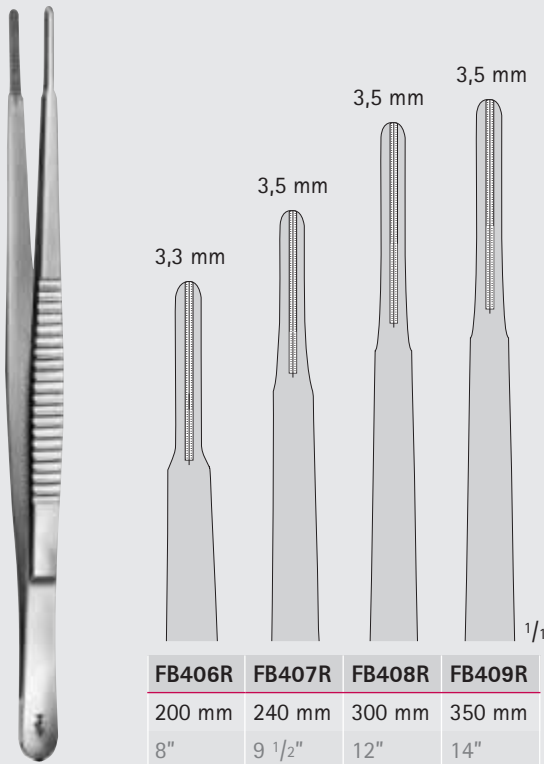

DE BAKEY

FB406R-FB409R

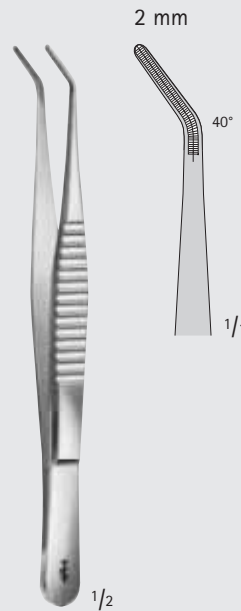

DE BAKEY

FB401R

150 mm, 6"

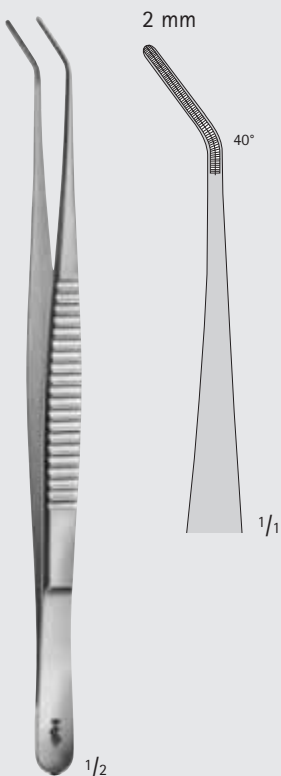

DE BAKEY

FB403R

200 mm, 8"

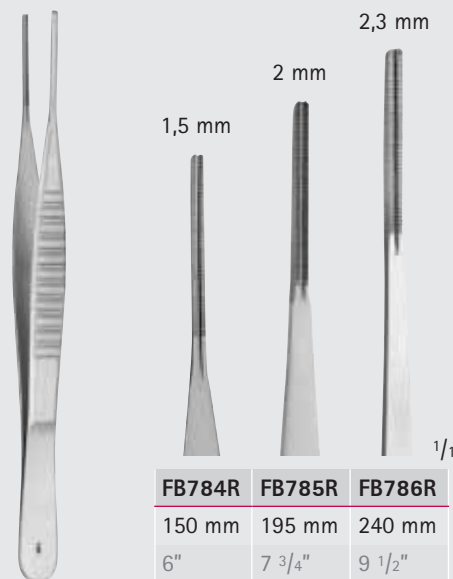

COOLEY

FB784R-FB786R



MILLIMETERS

Pinzetten – Dissecting- and Tissue Forceps

DUROGRIP® Atraumatische Pinzetten

DUROGRIP® Non-traumatic Dissecting Forceps

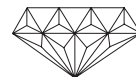

BD

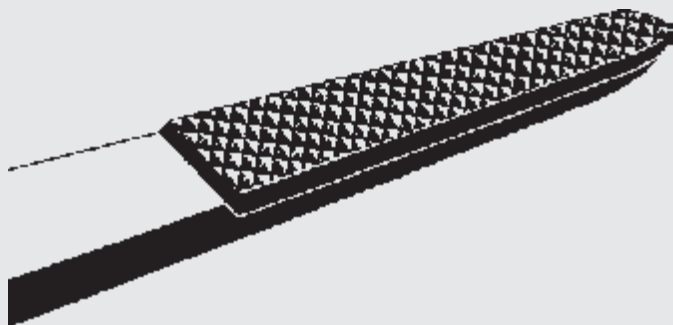

- Fein strukturiertes und präzise gearbeitetes Haftprofil
- sicheres und zugleich schonendes Fassen
- universell verwendbar
- unverwüstlich im Gebrauch
- Precisely worked out fine structure of carbide inserts
- thus firm and non-traumatic gripping of tissue
- universal in use
- long working life



DUROGRIP®-Pinzetten mit Hartmetall-Plättchen

Kennzeichnung: vergoldete Feder

DUROGRIP®-Dissecting Forceps with carbide inserts

Identification: gold-plated end

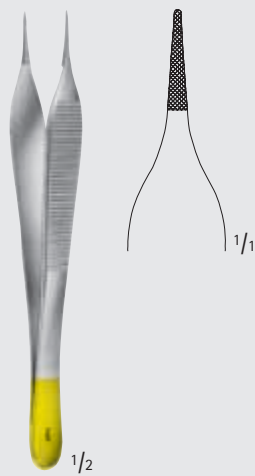

ADSON

BD151R

120 mm, 4 3/4"



BD154R	BD156R
145 mm	180 mm
5 3/4"	7"

BD154R-BD156R

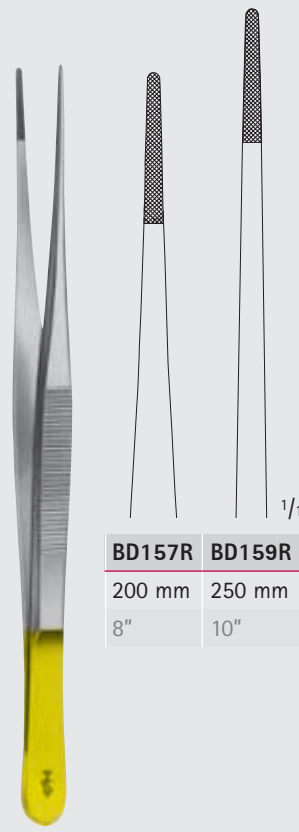

BD157R	BD159R
200 mm	250 mm
8"	10"

BD157R-BD159R



BD158R

230 mm, 9"

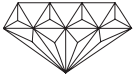

Pinzetten – Dissecting- and Tissue Forceps

DUROGRIP® Pinzetten

DUROGRIP® Dissecting Forceps

BD



Besonders sicheres und schonendes Fassen des Fadens durch kissenförmige Maulform
Cushion shaped tip ensures a safe and gentle grasping of the thread

1/2

BD180R

Nahtpinzette
Suture forceps
200 mm, 8"



1/1

1/2

FERRIS-SMITH

BD181R

175 mm, 7"



1/1

BD171R	BD173R
150 mm	230 mm
6"	9"

WANGENSTEEN

BD171R-BD173R



MILLIMETERS

Pinzetten – Dissecting- and Tissue Forceps

DUROGRIP® Pinzetten

DUROGRIP® Dissecting Forceps

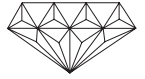

BD

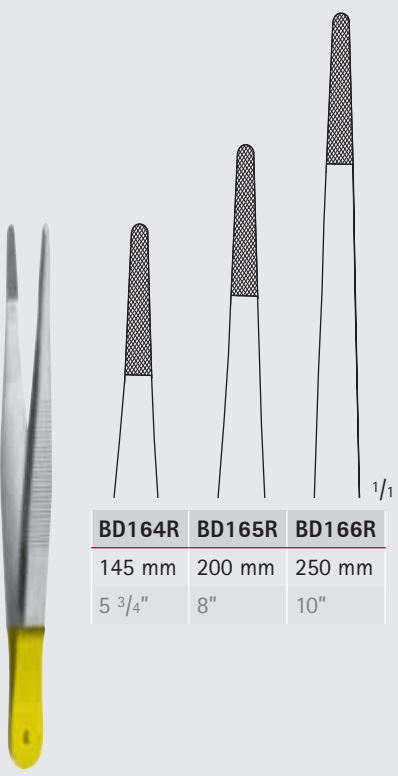

BD164R	BD165R	BD166R
145 mm	200 mm	250 mm
5 3/4"	8"	10"

STANDARD
BD164R-BD166R

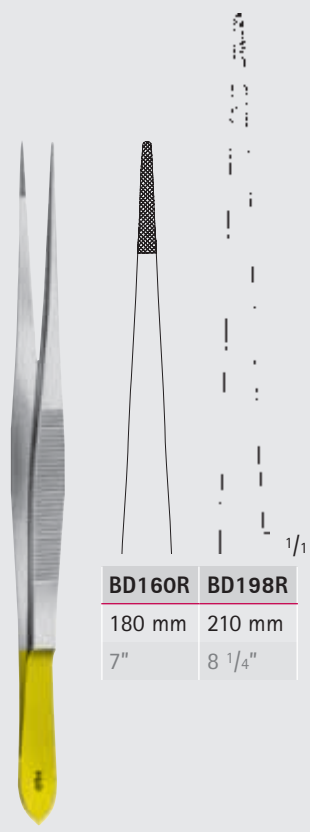

BD160R	BD198R
180 mm	210 mm
7"	8 1/4"

CUSHING
BD160R-BD198R
mit Schaber
with scraper end

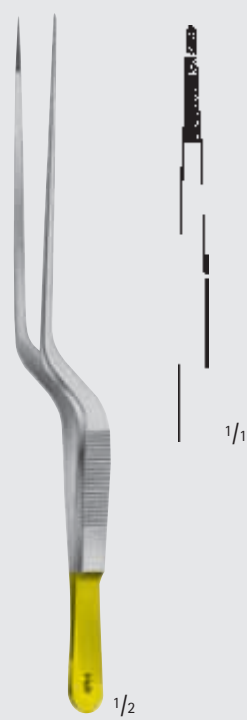

GRUENWALD
BD168R
185 mm, 7 1/4"

Pinzetten – Dissecting- and Tissue Forceps

Pinzetten, bajonettförmig gebogen
Forceps, Bayonet-Shaped

BD

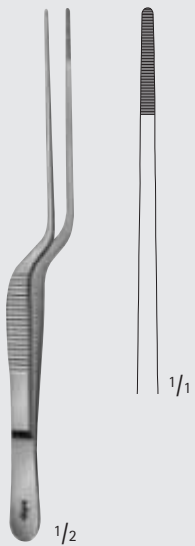

LUCAE

BD878R

140 mm, 5 1/2"

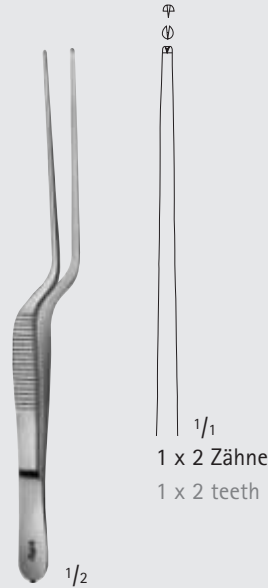

LUCAE

BD879R

140 mm, 5 1/2"



COTTLE

OL011R

Fixierpinzette
Forceps
140 mm, 5 1/2"

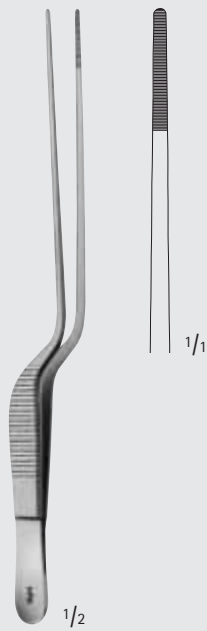

JANSEN

BD880R

160 mm, 6 1/4"

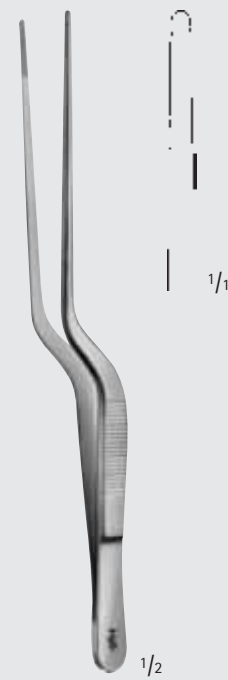

ADSON

BD870R

175 mm, 7"



MILLIMETERS

Pinzetten – Dissecting- and Tissue Forceps

Pinzetten, bajonettförmig gebogen

Forceps, Bayonet-Shaped

BD

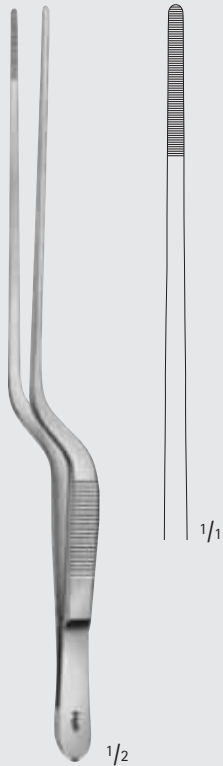

GRUENWALD

BD883R

200 mm, 8"

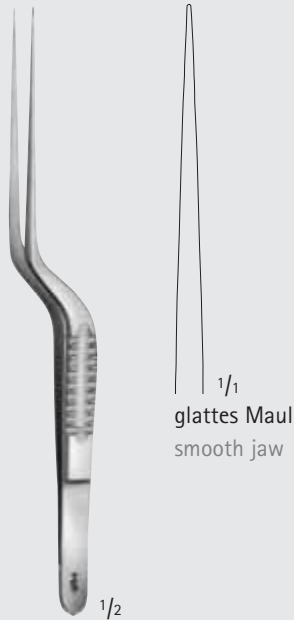

glattes Maul
smooth jaw

BD887R

160 mm, 6 1/4"

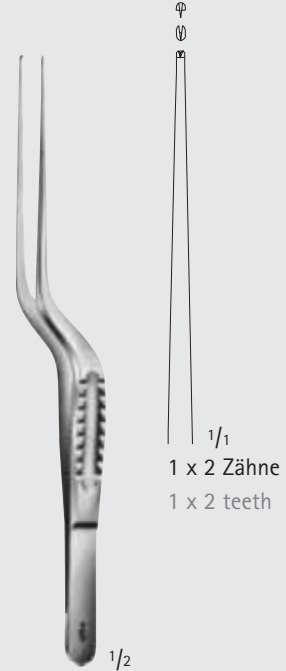

1 x 2 Zähne
1 x 2 teeth

BD888R

160 mm, 6 1/4"

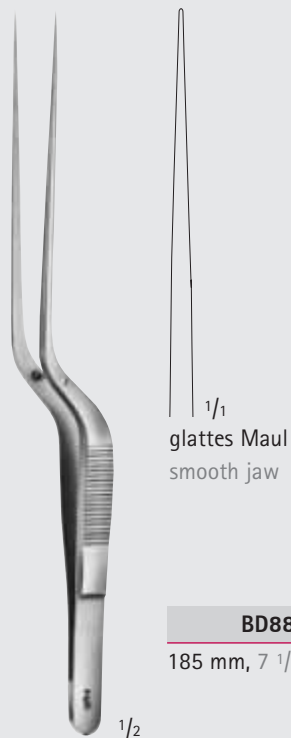

glattes Maul
smooth jaw

BD885R

185 mm, 7 1/4"

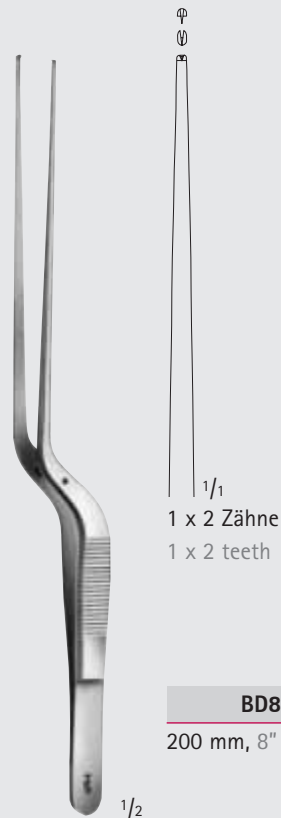

1 x 2 Zähne
1 x 2 teeth

BD886R

200 mm, 8"



Pinzetten – Dissecting- and Tissue Forceps

Pinzetten, kniegebogen
Forceps, Angular

BD



TROELTSCH

BD900R

100 mm, 4"

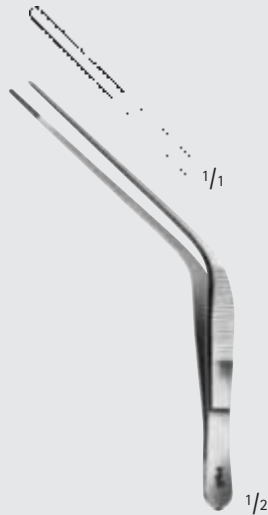

TROELTSCH

BD902R

115 mm, 4 1/2"



TROELTSCH

BD903R

115 mm, 4 1/2"

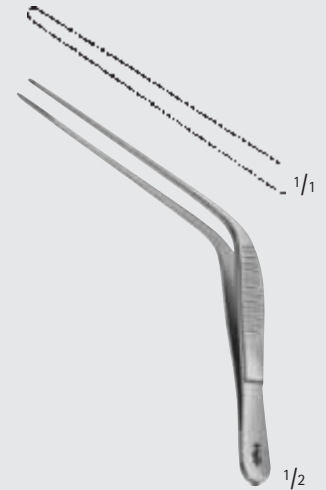

WILDE

BD904R

115 mm, 4 1/2"

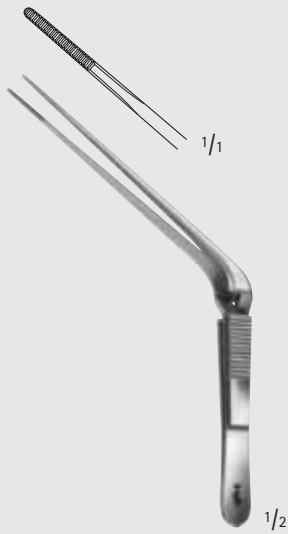

TROELTSCH

BD905R

selbstschließend
cross action
120 mm, 4 3/4"

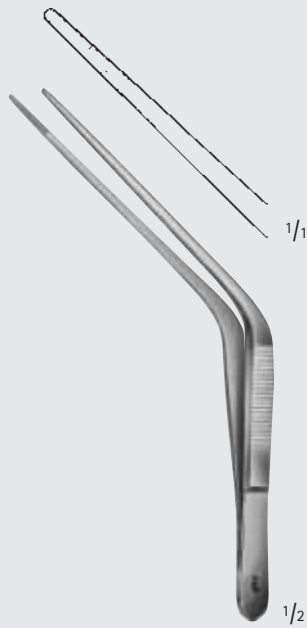

TROELTSCH

BD910R

140 mm, 5 1/2"

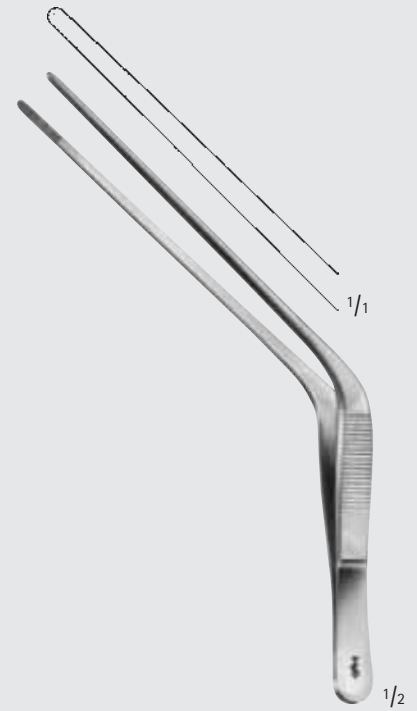

TROELTSCH

BD911R

170 mm, 6 3/4"



MILLIMETERS

Pinzetten – Dissecting- and Tissue Forceps

Feine chirurgische Pinzetten

Delicate Tissue Forceps

BD



BISHOP-HARMON

OC051R

Augenpinzette

Eye forceps

85 mm, 3 1/2"



ST. MARTIN

OC091R

Augenpinzette

Eye forceps

80 mm, 3 1/8"

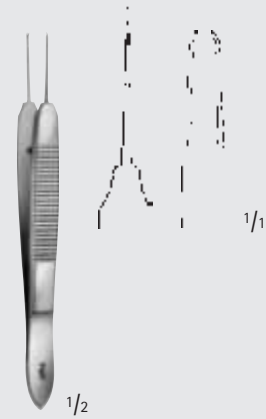

CASTROVIEJO

OC094R

Augenpinzette

Eye forceps

100 mm, 4"

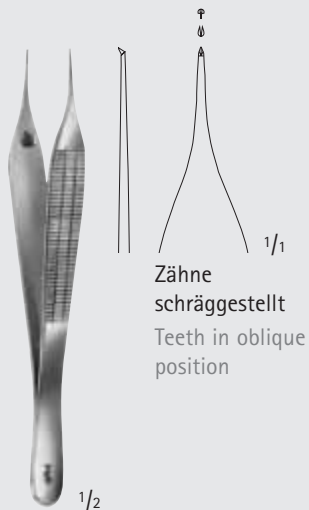

MICRO-ADSON-BIEMER

BD509R

120 mm, 4 3/4"

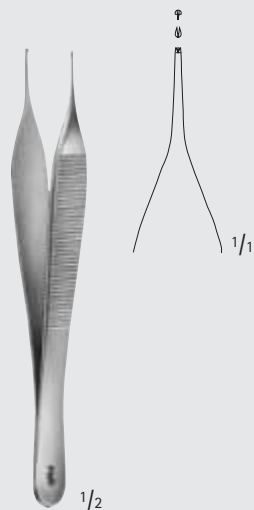

MICRO-ADSON

BD510R

120 mm, 4 3/4"

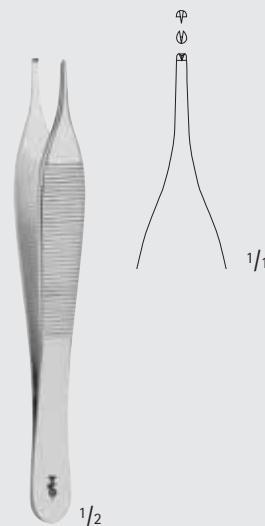

ADSON

BD511R

120 mm, 4 3/4"

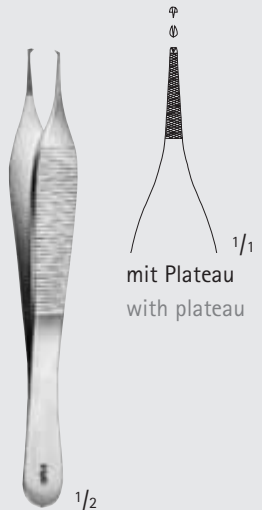

ADSON

BD512R

120 mm, 4 3/4"





Pinzetten – Dissecting- and Tissue Forceps

Feine chirurgische Pinzetten

Delicate Tissue Forceps

BD

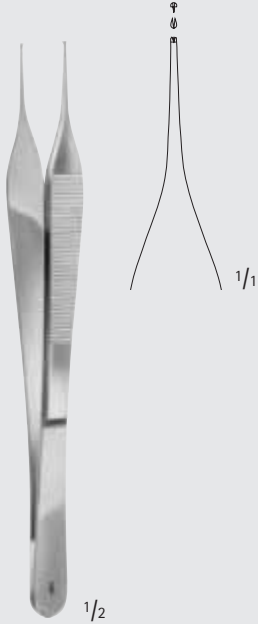

MICRO-ADSON

BD520R

150 mm, 6"



ADSON

BD522R

180 mm, 7"

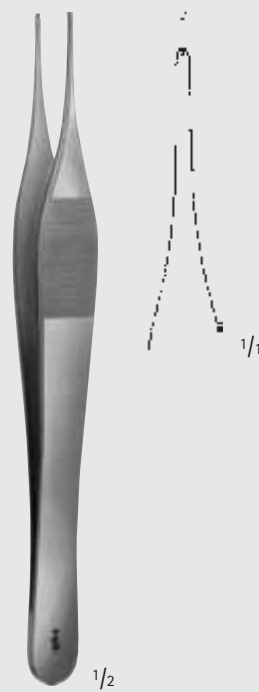

JEFFERSON

BD523R

180 mm, 7"

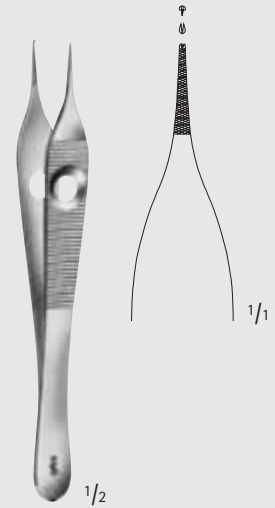

ADSON

BD508R

120 mm, 4 3/4"



ADSON

BD513R

120 mm, 4 3/4"

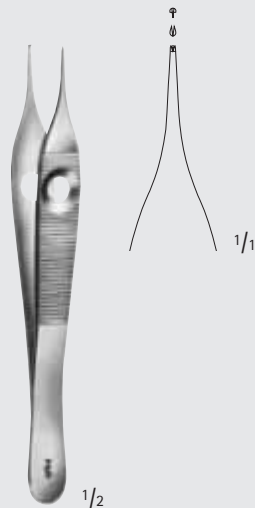

ADSON

BD506R

120 mm, 4 3/4"

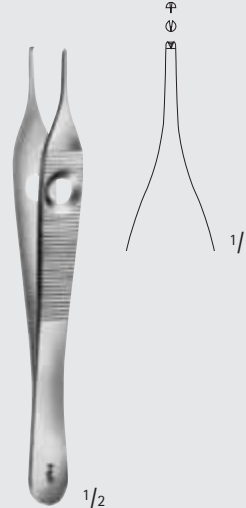

ADSON

BD507R

120 mm, 4 3/4"

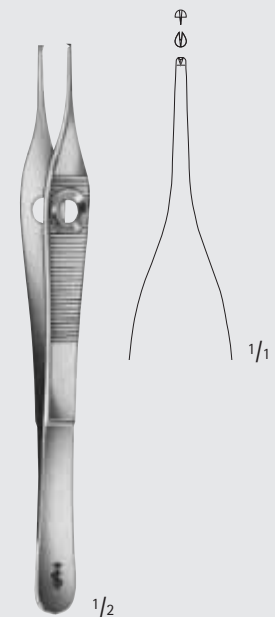

ADSON

BD521R

150 mm, 6"



MILLIMETERS

Pinzetten – Dissecting- and Tissue Forceps

Chirurgische Pinzetten

Tissue Forceps

BD

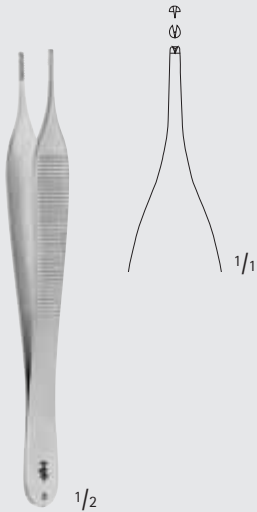

HUDSON

MB291R

125 mm, 4 7/8"

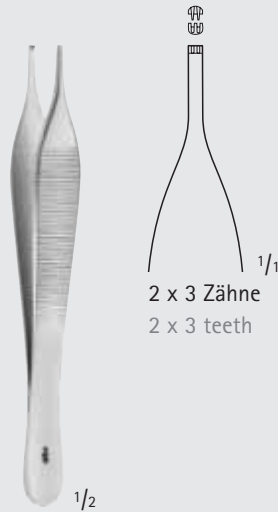

ADSON

MB454R

120 mm, 4 3/4"

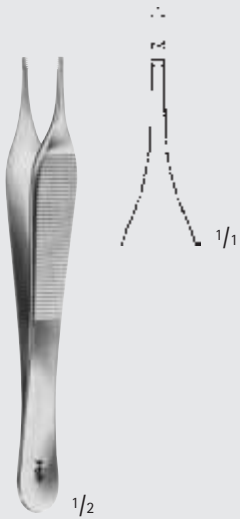

ADSON-BROWN

BD700R

Hautpinzette, scharf

Tissue forceps, sharp

120 mm, 4 3/4"

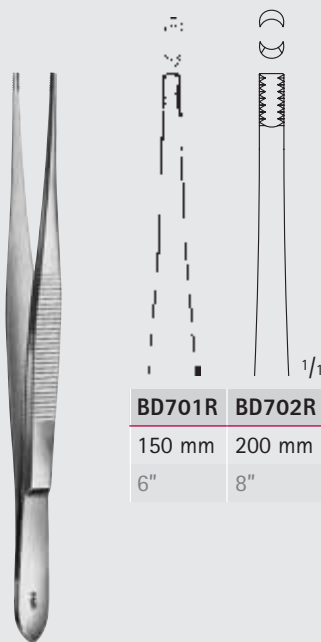

BROWN

BD701R-BD702R



GRAEFFE

OC100R

110 mm, 4 1/2"



Pinzetten – Dissecting- and Tissue Forceps

Feine chirurgische Pinzetten

Delicate Tissue Forceps

BD

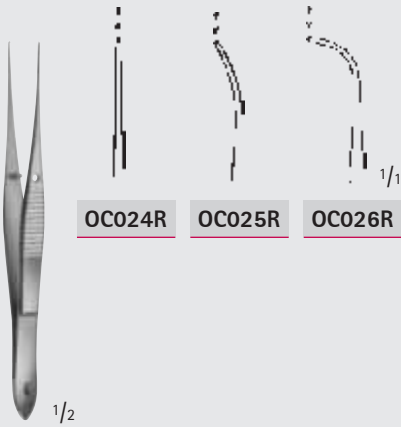

OC024R **OC025R** **OC026R**

OC024R-OC026R

sehr fein
very delicate
100 mm, 4"



BD500R

100 mm, 4"

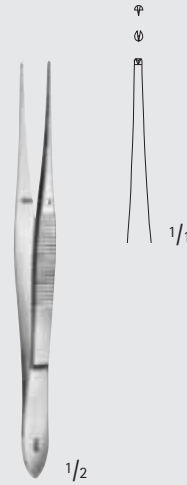

BD501R

110 mm, 4 3/8"

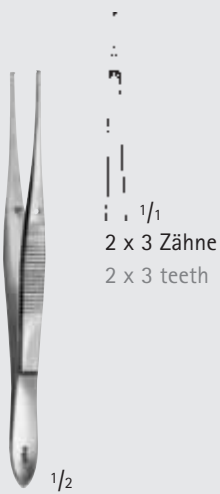

1/1
2 x 3 Zähne
2 x 3 teeth

BD502R

110 mm, 4 3/8"

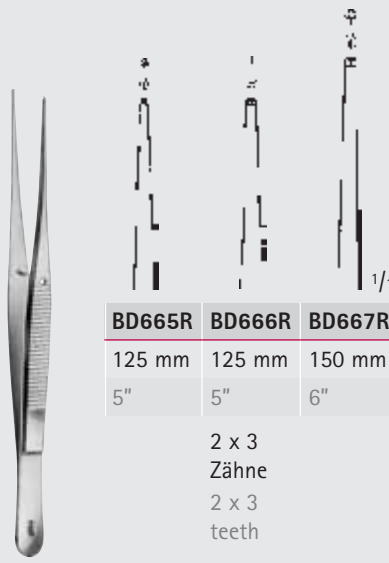

BD665R **BD666R** **BD667R**

125 mm 125 mm 150 mm
5" 5" 6"

2 x 3
Zähne
2 x 3
teeth

SEMKEN

BD665R-BD667R

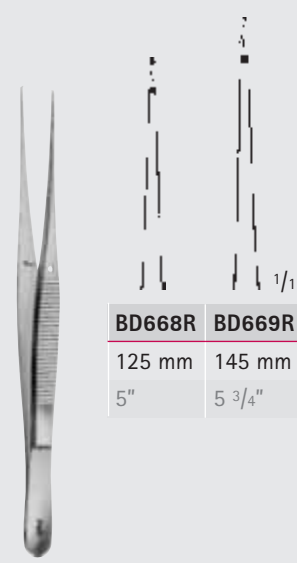

BD668R **BD669R**

125 mm 145 mm
5" 5 3/4"

SEMKEN

BD668R-BD669R



MILLIMETERS

Pinzetten – Dissecting- and Tissue Forceps

Feine chirurgische Pinzetten

Delicate Tissue Forceps

BD



GILLIES

BD660R

155 mm, 6"



MC INDOE

BD661R

150 mm, 6"

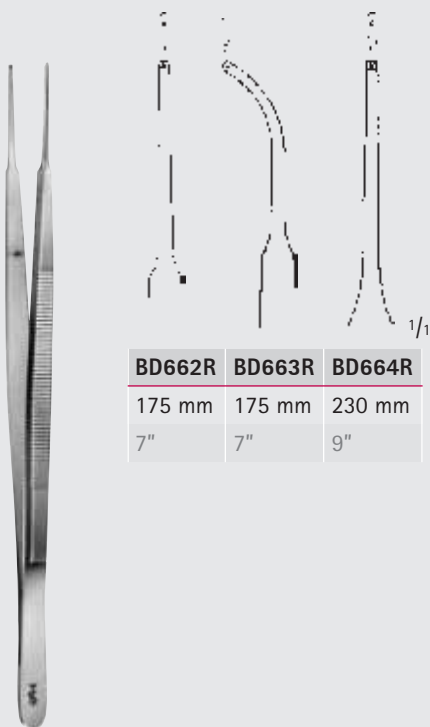

GERALD

BD662R-BD664R

BD662R	BD663R	BD664R
175 mm	175 mm	230 mm
7"	7"	9"

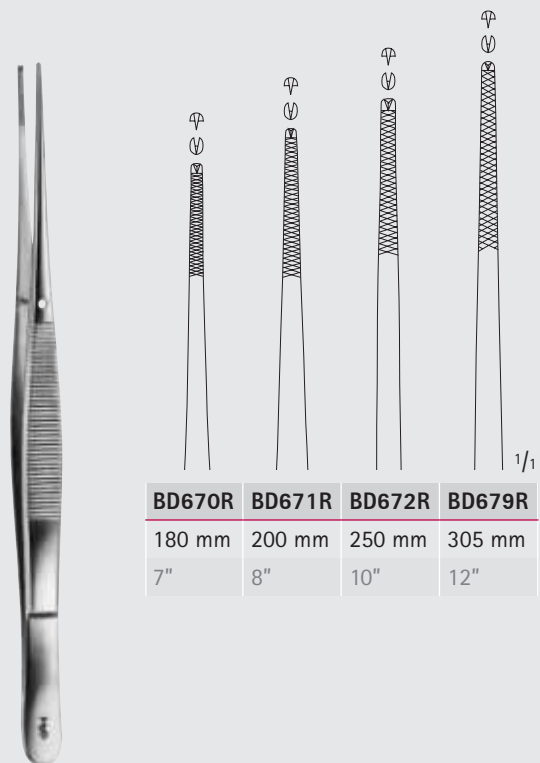

WAUGH

BD670R-BD679R

BD670R	BD671R	BD672R	BD679R
180 mm	200 mm	250 mm	305 mm
7"	8"	10"	12"



Pinzetten – Dissecting- and Tissue Forceps

Chirurgische Pinzetten
Tissue Forceps

BD



BROPHY

BD678R

200 mm, 8"



BD651R

200 mm, 8"



CUSHING

MD463

180 mm, 7"



MILLIMETERS

Pinzetten – Dissecting- and Tissue Forceps

Chirurgische Pinzetten

Tissue Forceps

BD

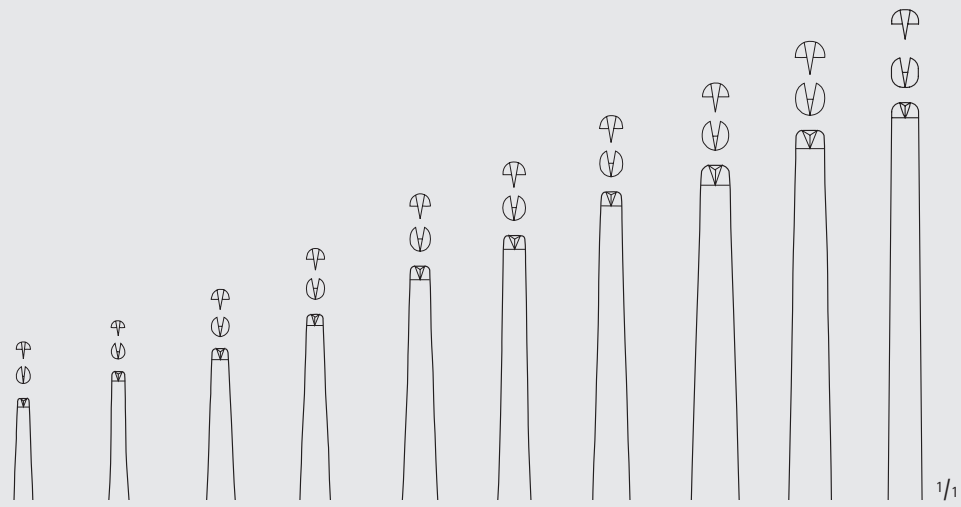

BD552R	BD553R	BD555R	BD557R	BD559R	BD560R	BD561R	BD562R	BD563R	BD564R
105 mm	115 mm	130 mm	145 mm	160 mm	180 mm	200 mm	250 mm	300 mm	350 mm
4 1/8"	4 1/2"	5 1/8"	5 3/4"	6 1/4"	7"	8"	10"	12"	14"

BD552R-BD564R
Standard-Modelle
Standard patterns

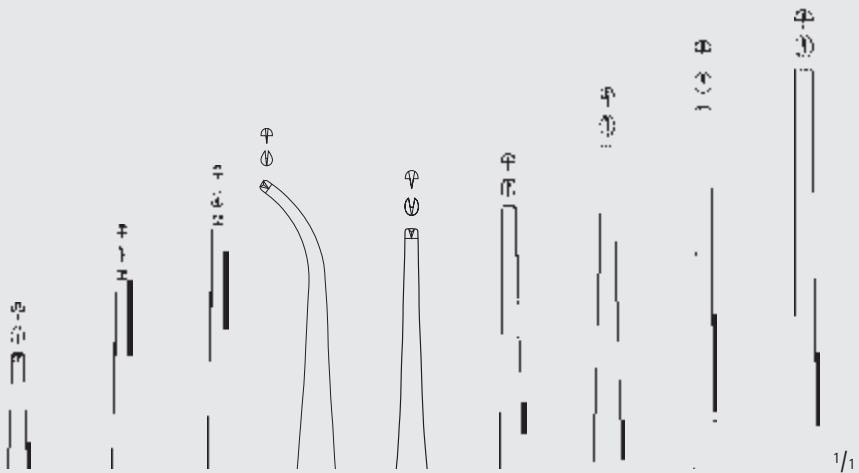

BD533R	BD535R	BD537R	BD527R	BD539R	BD540R	BD541R	BD542R	BD543R
115 mm	130 mm	145 mm	145 mm	160 mm	180 mm	200 mm	250 mm	300 mm
4 1/2"	5 1/8"	5 3/4"	5 3/4"	6 1/4"	7"	8"	10"	12"

BD527R-BD543R
mittelbreit
medium



Pinzetten – Dissecting- and Tissue Forceps

Chirurgische Pinzetten
Tissue Forceps

BD

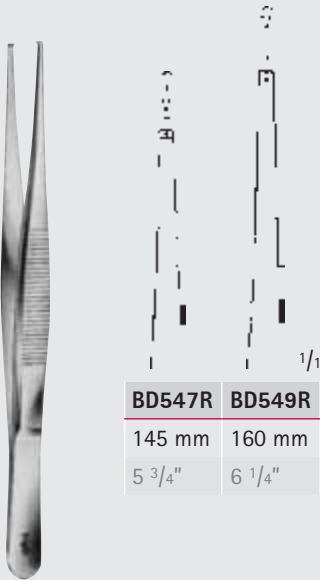

BD547R	BD549R
145 mm	160 mm
5 3/4"	6 1/4"

BD547R-BD549R

kräftiger als BD537R und BD539R
aber feiner als BD557R und BD559R
stronger as BD537R and BD539R
but finer than BD557R and BD559R

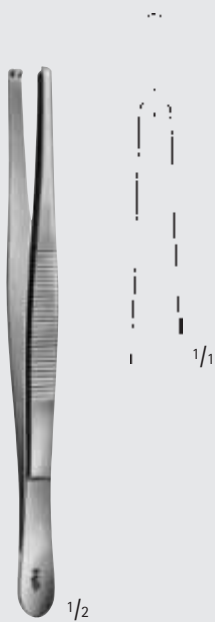

BD600R

kräftiges Modell
heavy pattern
145 mm, 5 3/4"

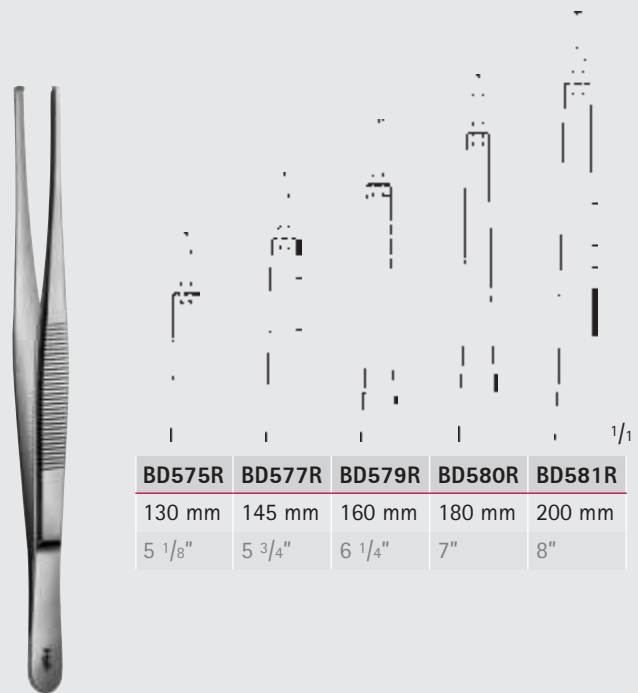

BD575R	BD577R	BD579R	BD580R	BD581R
130 mm	145 mm	160 mm	180 mm	200 mm
5 1/8"	5 3/4"	6 1/4"	7"	8"

BD575R-BD581R

2 x 3 Zähne
2 x 3 teeth



MILLIMETERS

Pinzetten – Dissecting- and Tissue Forceps

Chirurgische Pinzetten

Tissue Forceps

BD



BD587R	BD589R	BD591R
145 mm	160 mm	200 mm
5 3/4"	6 1/4"	8"

1/1

BD587R-BD591R

3 x 4 Zähne
3 x 4 teeth

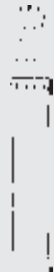

1/1
4 x 5 Zähne
4 x 5 teeth

1/2

BD597R

145 mm, 5 3/4"



1/1
4 x 5 Zähne
4 x 5 teeth

1/2

OFFICER

BD598R

150 mm, 6"

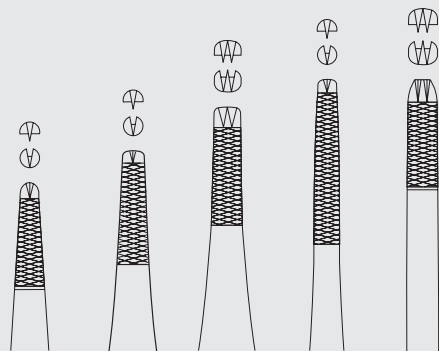

1/1

BD602R	BD603R	BD604R	BD606R	BD607R
125 mm	145 mm	145 mm	175 mm	175 mm
5"	5 3/4"	5 3/4"	7"	7"
		2 x 3 Zähne 2 x 3 teeth		2 x 3 Zähne 2 x 3 teeth

LANE

BD602R-BD607R



Pinzetten – Dissecting- and Tissue Forceps

Chirurgische Pinzetten
Tissue Forceps

BD



BD608R	BD609R
125 mm	150 mm
8"	6"

1/1

TREVES

BD608R-BD609R



1/2

BONNEY

BD693R

175 mm, 7"



1/1

1/2

JACKSON-BURROWS

BD704R

140 mm, 5 1/2"

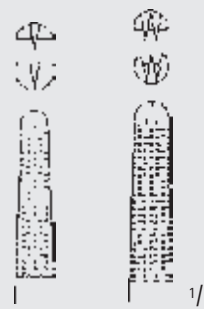

1/1

BD610R

BD611R

3 x 4
Zähne
3 x 4
teeth

1/2

RAMSEY

BD610R-BD611R

180 mm, 7"



MILLIMETERS

Pinzetten – Dissecting- and Tissue Forceps

Chirurgische Pinzetten

Tissue Forceps

BD



1/1

1/2

CHARNLEY

BD705R

180 mm, 7"



1/1

BD690R	BD692R
150 mm	200 mm
6"	8"

STRASSBURGER MODELL

BD690R-BD692R



1/1

1/2

BD185R

Nahtpinzette
Suture forceps
300 mm, 12"



Pinzetten – Dissecting- and Tissue Forceps

Chirurgische Pinzetten

Tissue Forceps



BD735R	BD736R
150 mm	200 mm
6"	8"
4 x 5 Zähne	4 x 5 Zähne
4 x 5 teeth	4 x 5 teeth

ADLERKREUTZ

BD735R-BD736R

Gefäß- und Tumorpinzette
Vascular- and tumor forceps

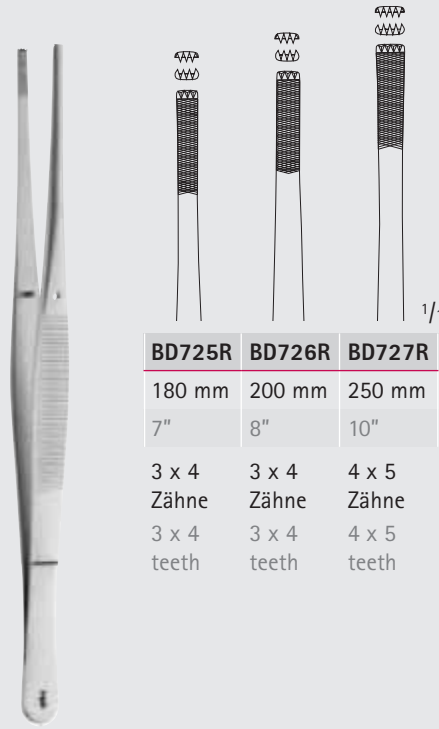

BD725R	BD726R	BD727R
180 mm	200 mm	250 mm
7"	8"	10"
3 x 4 Zähne	3 x 4 Zähne	4 x 5 Zähne
3 x 4 teeth	3 x 4 teeth	4 x 5 teeth

STILLE-BARRAYA

BD725R-BD727R

Gefäß- und Tumorpinzetten
Vascular- and tumor forceps



RUSS. MODELL

BD755R

150 mm, 6"



RUSS. MODELL

BD760R

200 mm, 8"



SELMAN

BD750R

155 mm, 6"

BD

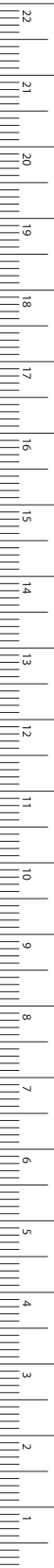

MILLIMETERS

Pinzetten – Dissecting- and Tissue Forceps

Lungenfasspinzetten, Darmpinzetten

Lung Grasping Dissecting Forceps, Intestinal Forceps

BD

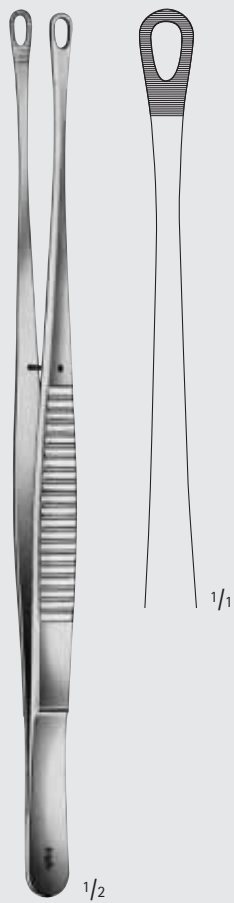

TUTTLE

BD801R

Lungenfasspinzette
Lung grasping forceps
230 mm, 9"

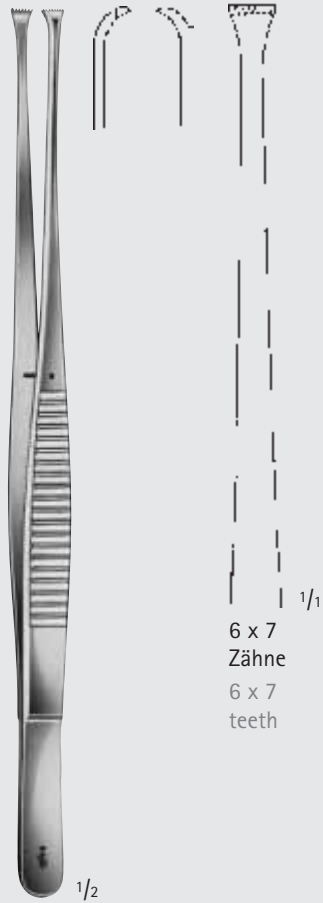

NELSON

BD802R

Lungenfasspinzette
Lung grasping forceps
230 mm, 9"



DUVAL

BD820R

Darmpinzette
Intestinal forceps
140 mm, 5 1/2"

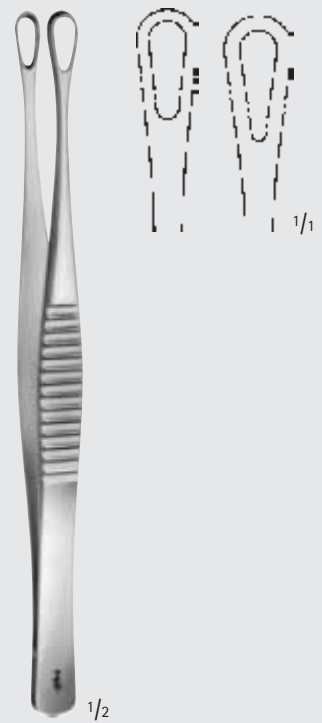

DENIS- BROWNE

EA027R

Darmpinzette
Intestinal forceps
190 mm, 7 1/2"



Pinzetten – Dissecting- and Tissue Forceps

Splitterpinzetten, Splitterzangen
Splinter Forceps



BD952R

Splitterpinzette
Splinter forceps
80 mm, 3 1/8"

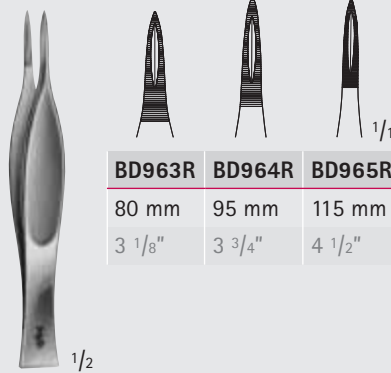

FEILCHENFELD

BD963R-BD965R

Splitterpinzetten
Splinter forceps



HUNTER

BD980R

Splitterpinzette
Splinter forceps
105 mm, 4 1/8"

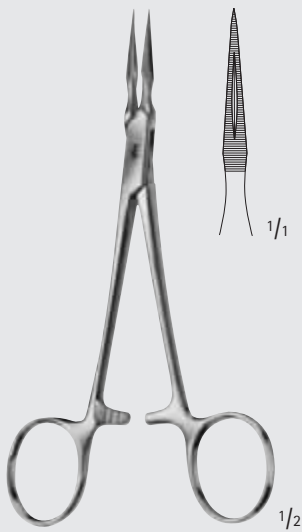

STIEGLITZ

BD992R

Splitterzange
Splinter forceps
140 mm, 5 1/2"

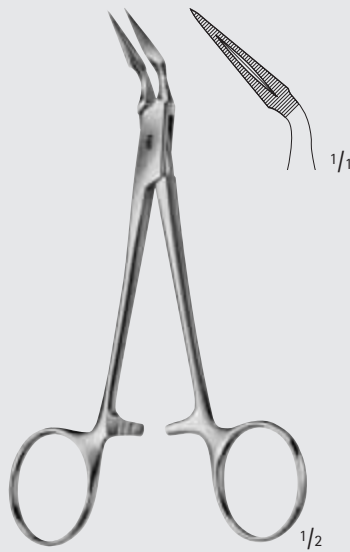

STIEGLITZ

BD993R

Splitterzange
Splinter forceps
140 mm, 5 1/2"

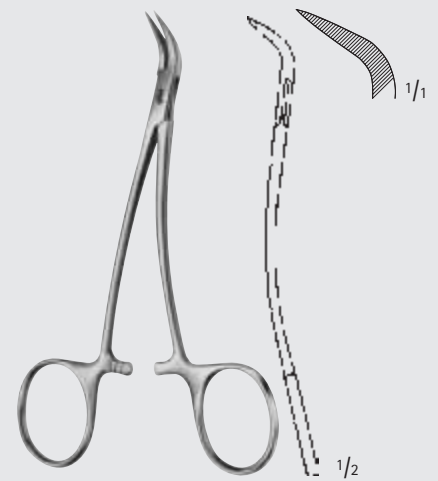

PEET

BD995R

Splitterzange
Splinter forceps
120 mm, 4 3/4"

BD

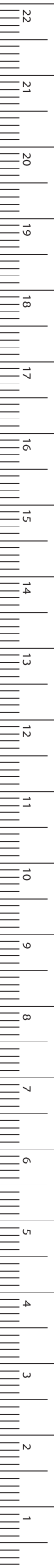

MILLIMETERS

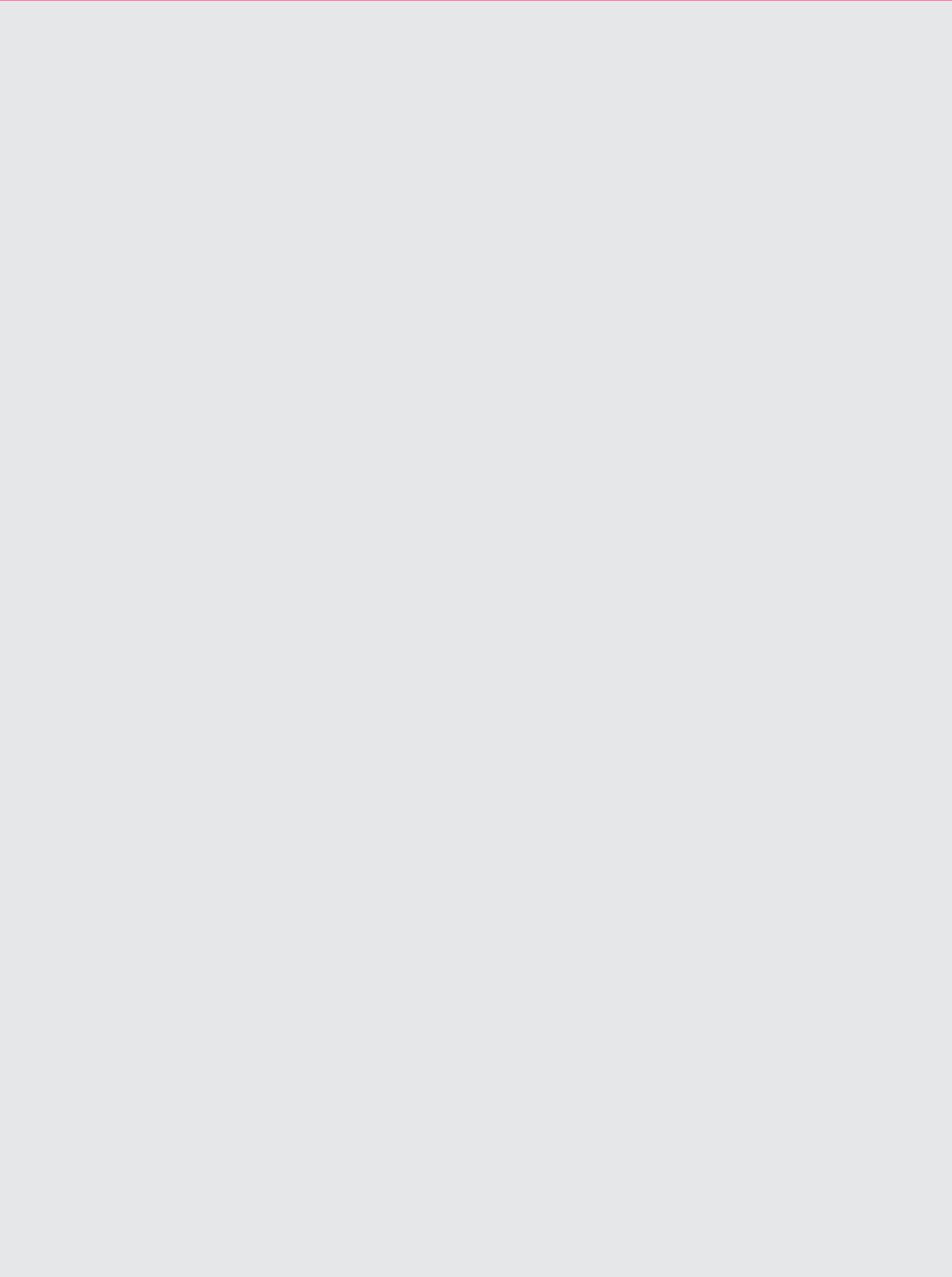

BF



Korn- und Tupferzangen,
Waschzangen, Tuchklemmen
Sponge- and Dressing-Forceps,
Washing Forceps, Towel Clamps

Korn- und Tupferzangen – Sponge- and Dressing Forceps

Korn- und Tupferzangen
Sponge- and Dressing Forceps

BF

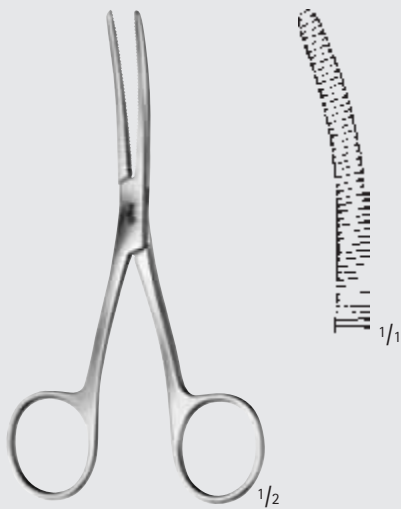

BRYANT

BF003R

130 mm, 5 1/8"



LISTER

BF004R-BF008R

Sinusklemmen
Sinus forceps

BF004R	BF006R	BF008R
130 mm	160 mm	175 mm
5 1/8"	6 1/4"	7"

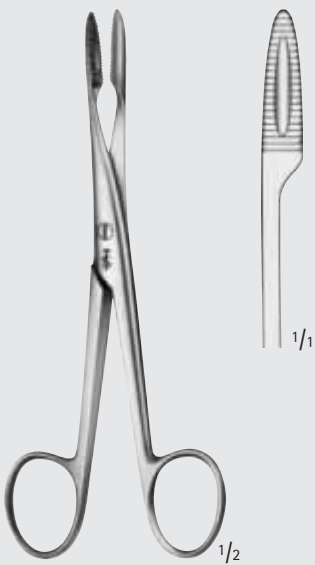

BF010R

ohne Sperre
without ratchet
145 mm, 5 3/4"

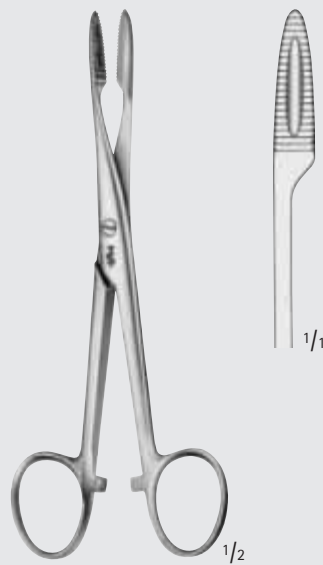

BF016R

mit Sperre
with ratchet
145 mm, 5 3/4"



BF021R

175 mm, 7"

Korn- und Tupferzangen – Sponge- and Dressing Forceps

Korn- und Tupferzangen
Sponge- and Dressing Forceps

BF

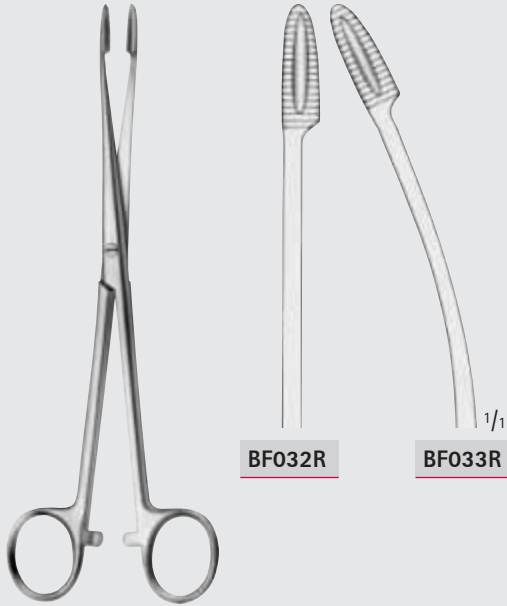

BF032R

BF033R

GROSS

BF032R-BF033R

mit Sperre
with ratchet
180 mm, 7"

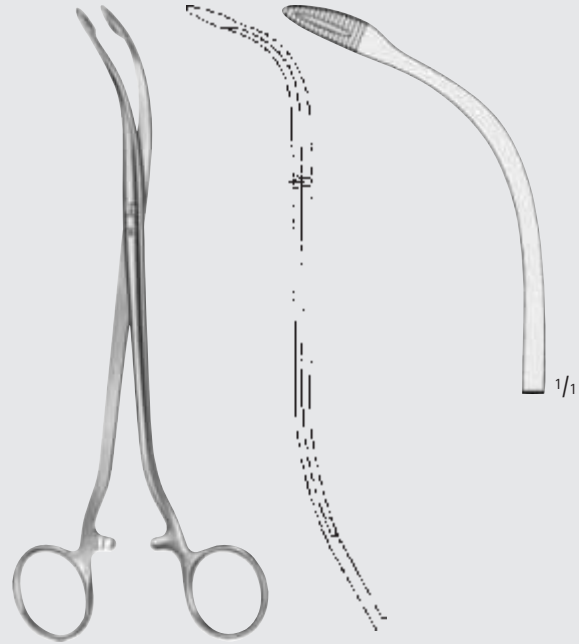

DUPLAY

OM485R

190 mm, 7 1/2"

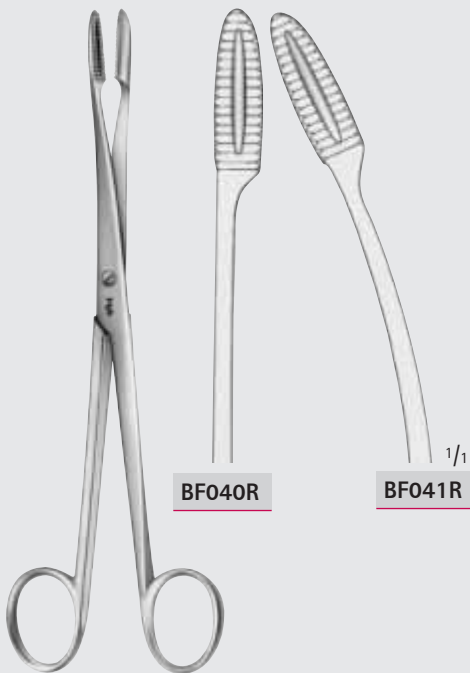

BF040R

BF041R

GROSS

BF040R-BF041R

ohne Sperre
without ratchet
200 mm, 8"

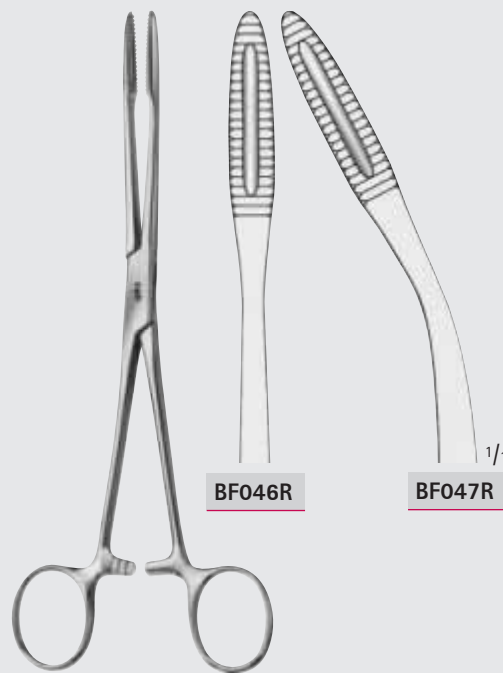

BF046R

BF047R

GROSS

BF046R-BF047R

200 mm, 8"

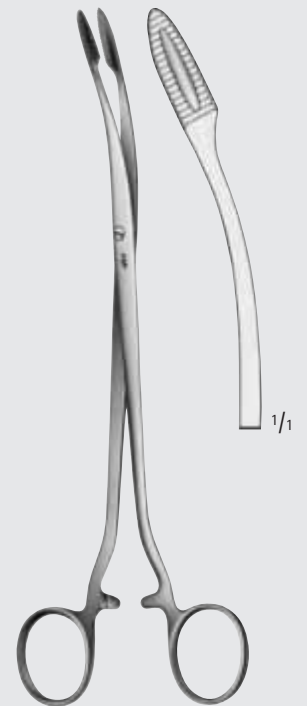

DUPLAY

BF027R

210 mm, 8 1/4"

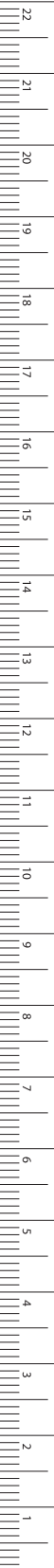

MILLIMETERS

Korn- und Tupferzangen – Sponge- and Dressing Forceps

Korn-, Tupfer- und Waschzangen
Sponge- and Dressing Forceps

BF



AESCULAP

BF060R-BF061R

220 mm, 8 3/4"

BF060R

BF061R



ULRICH-AESCULAP

BF062R-BF065R

BF062R

265 mm

10 1/2"

BF063R

265 mm

10 1/2"

BF065R

350 mm

14"

Korn- und Tupferzangen – Sponge- and Dressing Forceps

Korn- und Tupferzangen
Sponge- and Dressing Forceps

BF

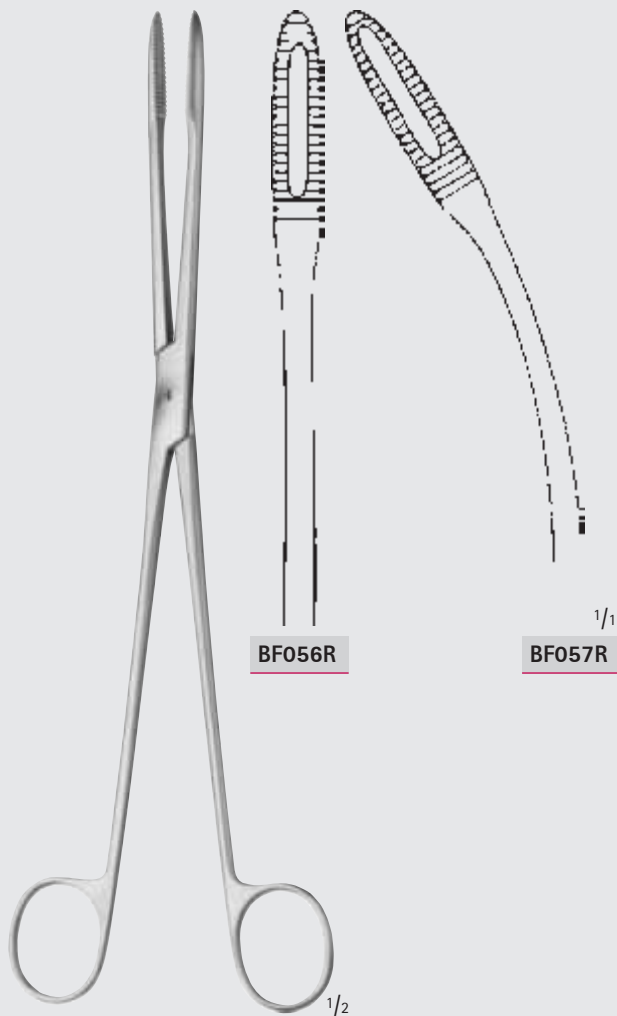

BF056R

BF057R

1/1

1/2

MAIER

BF056R-BF057R

ohne Sperre
without ratchet
265 mm, 10 1/2"

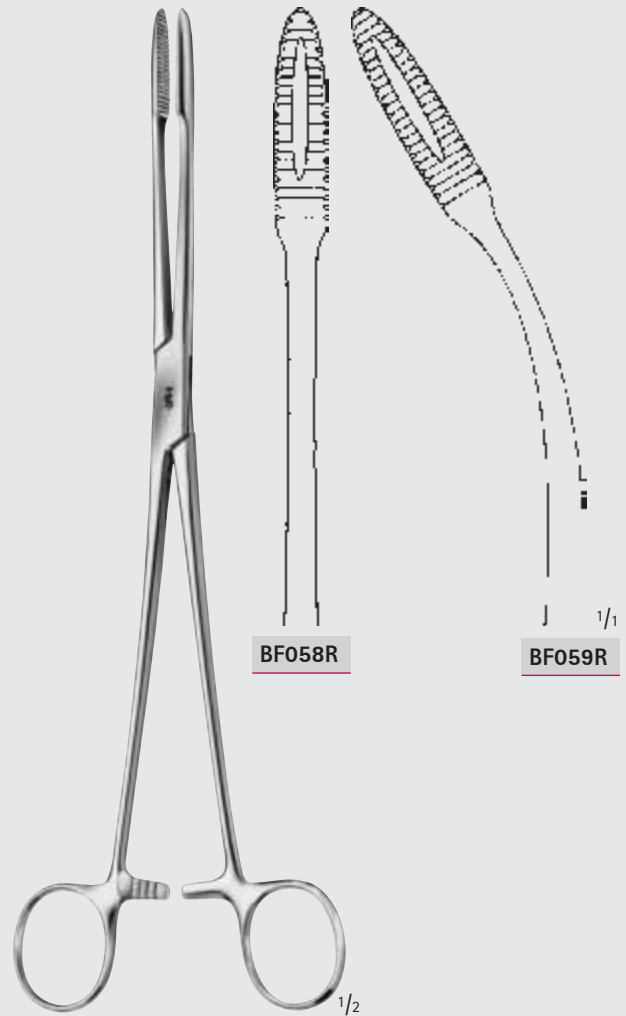

BF058R

BF059R

1/1

1/2

MAIER

BF058R-BF059R

mit Sperre
with ratchet
265 mm, 10 1/2"



MILLIMETERS

Korn- und Tupferzangen – Sponge- and Dressing Forceps

Korn- und Tupferzangen
Sponge- and Dressing Forceps

BF



SIMS-MAIER

BF076R-BF078R

BF076R
280 mm
11"

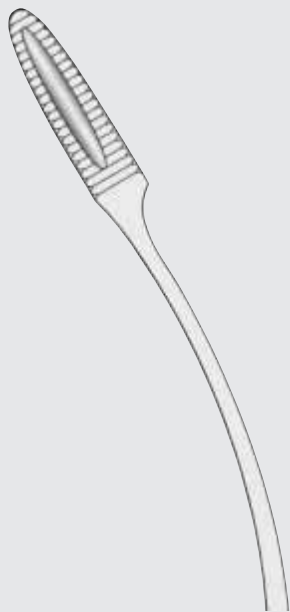

BF077R
280 mm
11"

BF078R
350 mm
14"



¹/₁

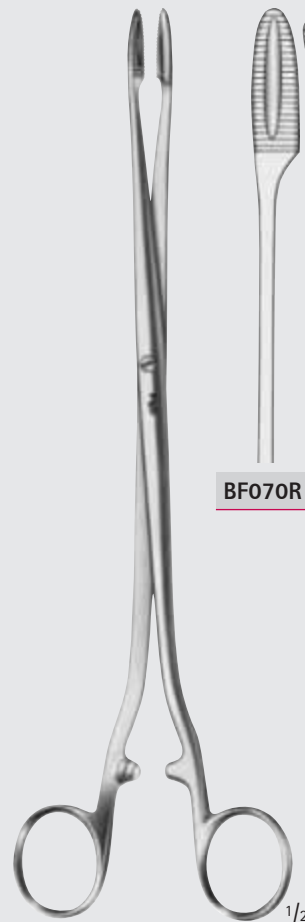

BF070R-BF071R

240 mm, 9 1/2"

BF070R



BF071R



¹/₁

¹/₂

Korn- und Tupferzangen – Sponge- and Dressing Forceps

Korn- und Tupferzangen
Sponge- and Dressing Forceps

BF



BF091R

COLLIN

BF091R

240 mm, 9 1/2"



BF092R

CHERON

BF092R

Griffe seitwärts abgewinkelt
Handles angled to side
240 mm, 9 1/2"

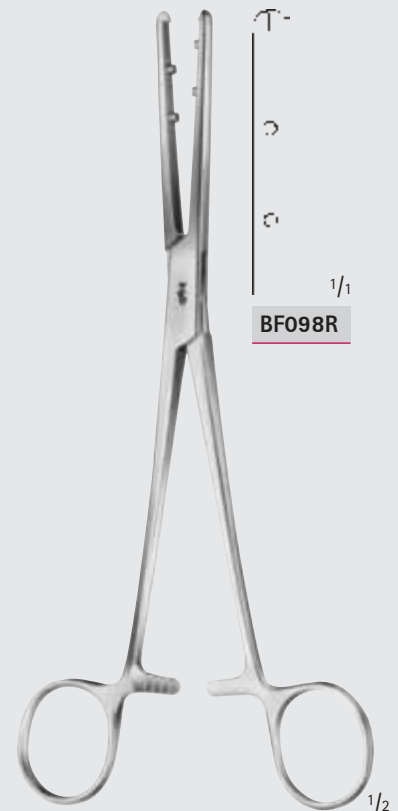

BF098R

EMMET

BF098R

210 mm, 8 1/4"



Korn- und Tupferzangen – Sponge- and Dressing Forceps

Tupfer-, Schwamm-, Organ- und Gewebefasszangen

Dressing-, Sponge Holding-, Organ- and Tissue Grasping Forceps

BF



BF112R

BF113R

FOERSTER-BALLEGER

BF112R-BF113R

180 mm, 7"

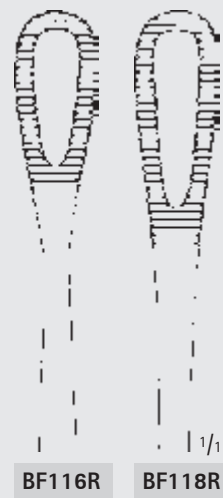

BF116R

BF118R

180 mm

250 mm

7"

10"

RAMPLEY

BF116R-BF118R



BF120R

glattes Maul
smooth jaws

BF121R

glattes Maul
smooth jaws

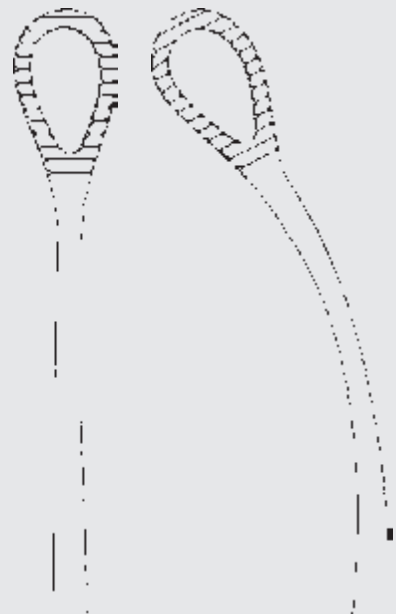

BF122R

BF123R

FOERSTER-BALLEGER

BF120R-BF123R

245 mm, 9 3/4"



DE BAKEY Zahnung

Toothing DE BAKEY

Korn- und Tupferzangen – Sponge- and Dressing Forceps

ARAUMATA®

Organ- und Gewebefasszangen
Organ- and Tissue Grasping Forceps

BF

2:3 Zahnreihen

2:3 Teeth rows

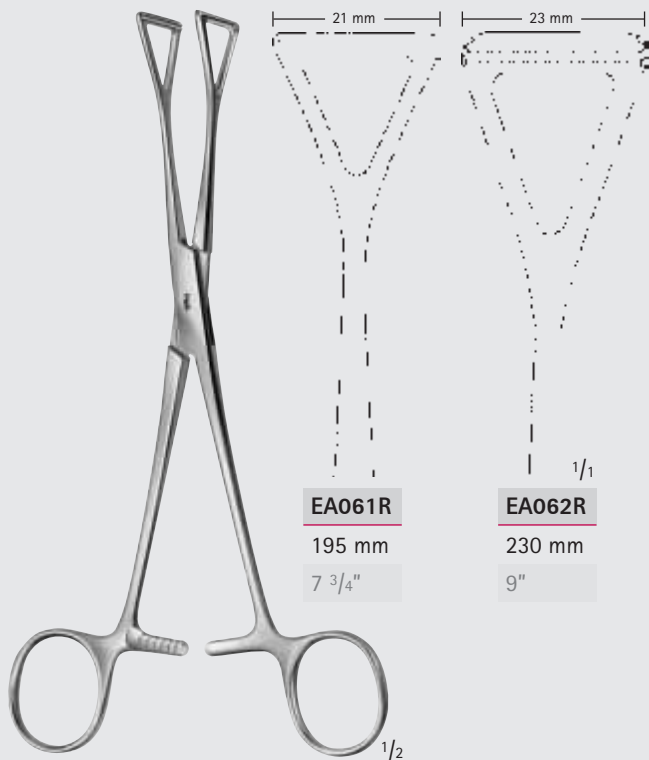

EA061R

195 mm
7 3/4"

EA062R

230 mm
9"

COLLIN

EA061R-EA062R

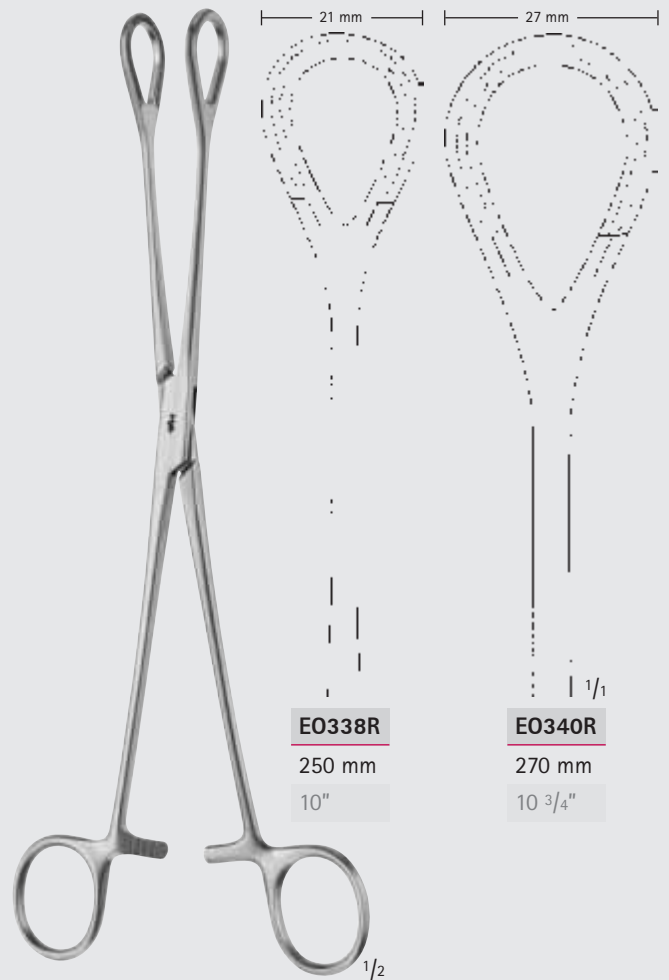

E0338R

250 mm
10"

E0340R

270 mm
10 3/4"

E0338R-E0340R



MILLIMETERS

Korn- und Tupferzangen – Sponge- and Dressing Forceps

Tupfer-, Schwamm-, Organ- und Gewebefasszangen

Dressing-, Sponge Holding-, Organ- and Tissue Grasping Forceps

BF



COLLIN

AN709R-BH908R



BH906R

160 mm

6 1/4"



BH908R

160 mm

6 1/4"



AN709R

170 mm

6 3/4"



HEYWOOD-SMITH

AN710R

200 mm, 8"



AN710R

1 1/1



HEYWOOD-SMITH MODIF.

AN711R

215 mm, 8 1/2"



AN711R

1 1/1



Korn- und Tupferzangen – Sponge- and Dressing Forceps

Tupfer-, Schwamm-, Organ- und Gewebefasszangen
Dressing-, Sponge Holding-, Organ- and Tissue Grasping Forceps

BF



E0310R

HEYWOOD-SMITH

E0310R

250 mm, 10"



E0315R

NOTO

E0315R

280 mm, 11"

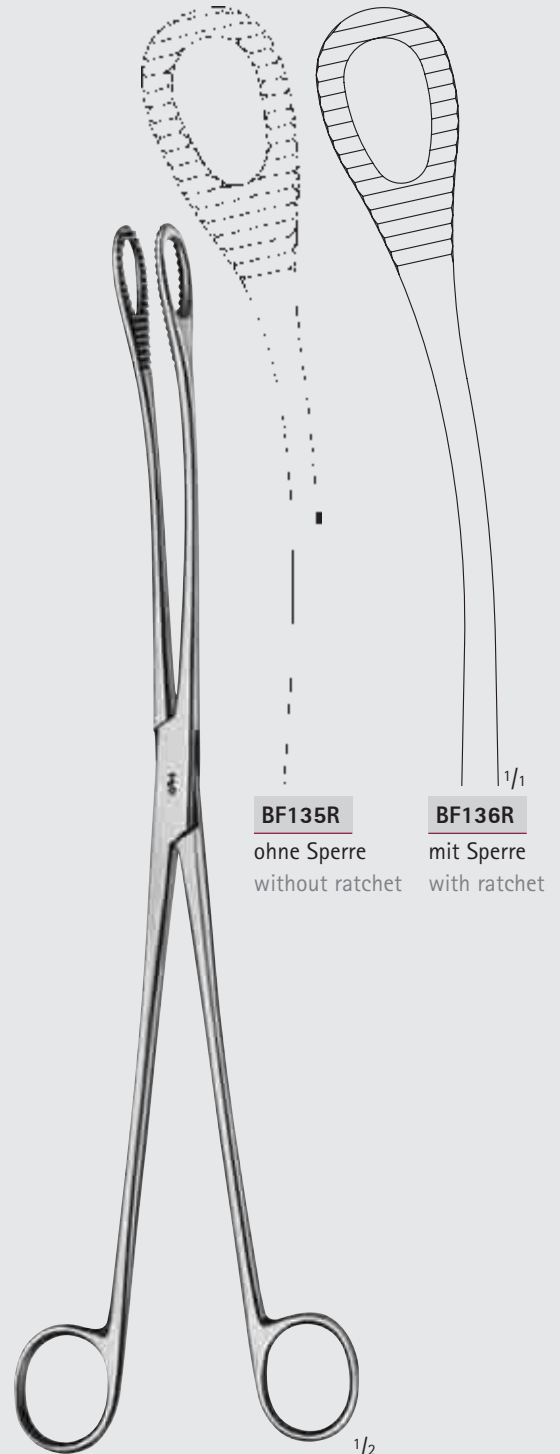

BF135R
ohne Sperre
without ratchet

BF136R
mit Sperre
with ratchet

KELLY

BF135R-BF136R

320 mm, 12 3/4"



MILLIMETERS

Korn- und Tupferzangen – Sponge- and Dressing Forceps

Sehnenfazzangen

Tendon Seizing Forceps

BF

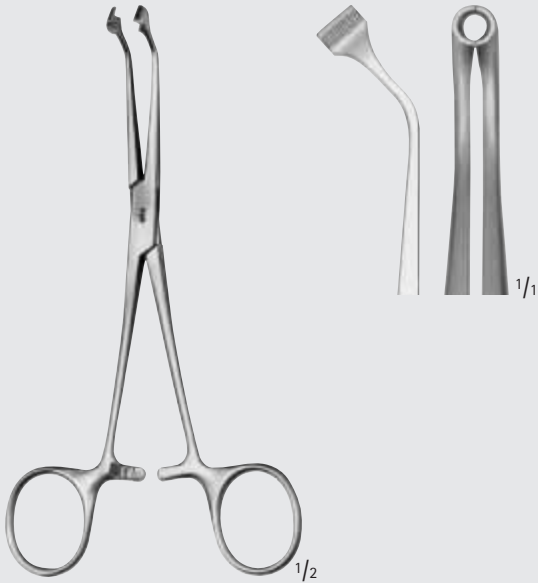

HERZ

BF303R

Sehnenfazzange

Tendon seizing forceps

155 mm, 6"



JACKSON

BF306R

Sehnenfazzange

4 x 5 Zähne

Tendon seizing forceps

4 x 5 teeth

150 mm, 6"



FO950R

Sehneneinflechtklamme

Tendon interlacing forceps

150 mm, 6"

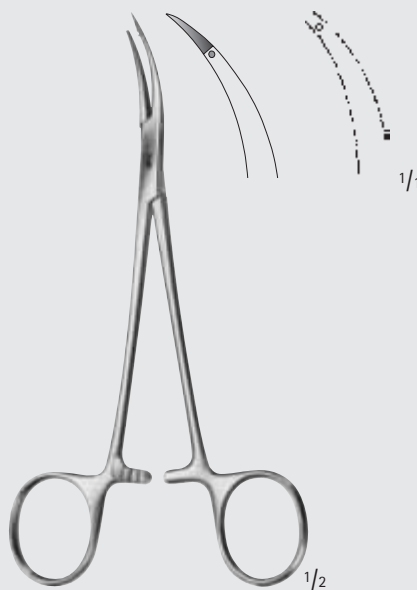

FO951R

Sehneneinflechtklamme

Tendon interlacing forceps

150 mm, 6"

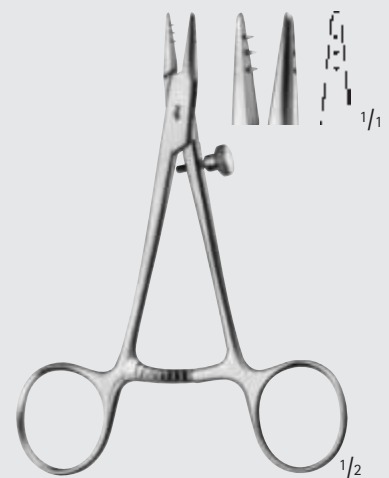

BF307R

Sehnenfazzange

Tendon seizing forceps

120 mm, 4 3/4"

Korn- und Tupferzangen – Sponge- and Dressing Forceps

Sehnenfasszangen Tendon Seizing Forceps

BF

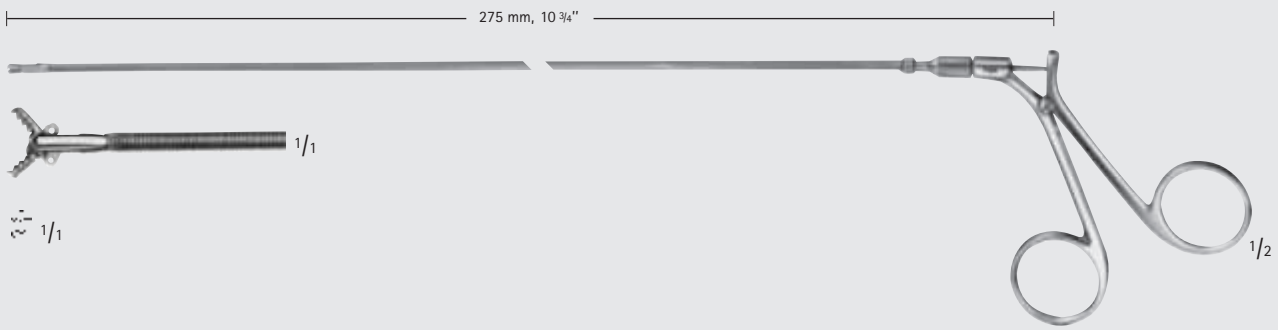

JÄGER

BF325R

Sehnen- und Kreuzband-
Durchziehzange
flexibler Schaft

Tendon- and cross ligament
passing forceps
flexible shaft



BF315R	BF316R	BF324R	BF326R
gebogen curved	gebogen curved	gerade straight	gerade straight
150 mm	185 mm	150 mm	185 mm
6"	7 1/4"	6"	7 1/4"

BRAND

BF315R-BF326R

Sehnenführungszangen
Tendon holding forceps



KLEINERT-KUTZ

BF320R

Sehnedurchziehzange
Tendon passing forceps
205 mm, 8"



MILLIMETERS

Korn- und Tupferzangen – Sponge- and Dressing Forceps

Arterien- und Gewebefassungen

Artery Traction- and Tissue Grasping Forceps

weitere Gewebefassungen siehe Rubrik EA
further Tissue grasping forceps see section EA



POIRIER

BF299R

125 mm, 5"

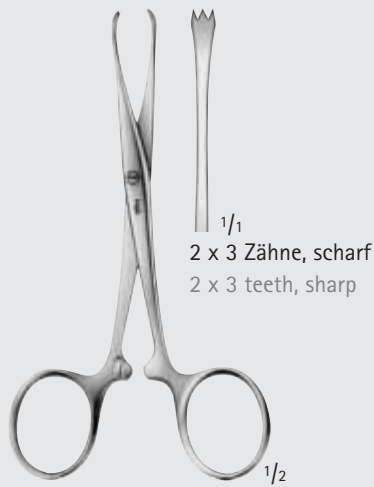

CHAPUT

BF300R

125 mm, 5"



TUFFIER

BF301R

125 mm, 5"

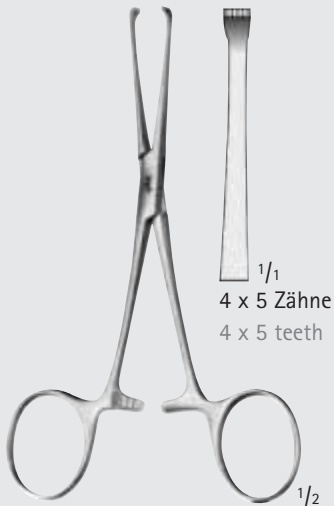

BABY-ALLIS

EA012R

130 mm, 5 1/8"

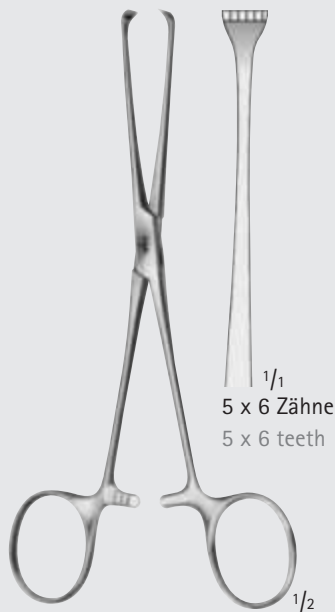

BOYS-ALLIS

EA010R

155 mm, 6"

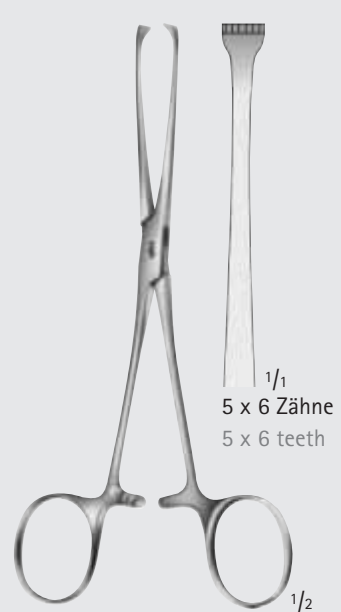

ALLIS

EA016R

155 mm, 6"

BF





Korn- und Tupferzangen – Sponge- and Dressing Forceps Organ- und Gewebefasszangen Organ- and Tissue Grasping Forceps

BF

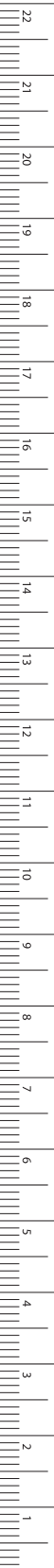

MILLIMETERS

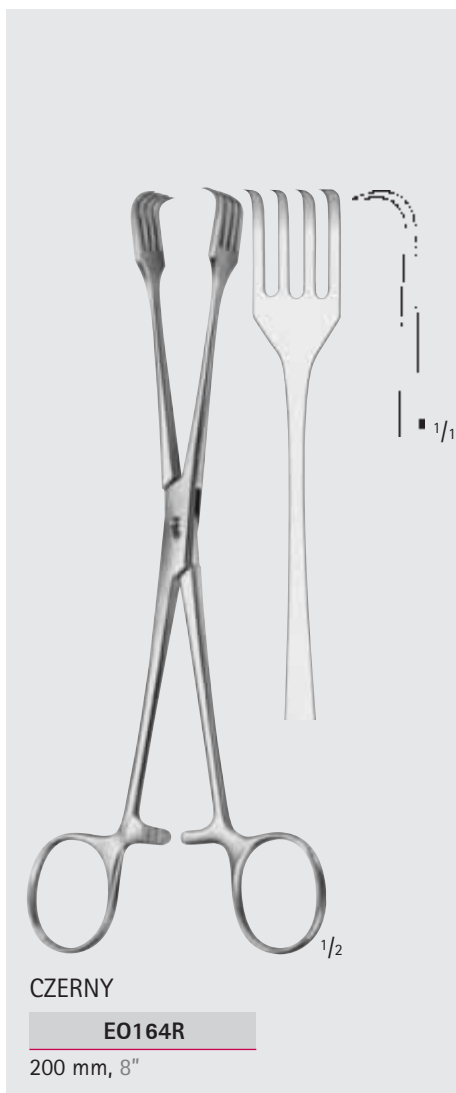
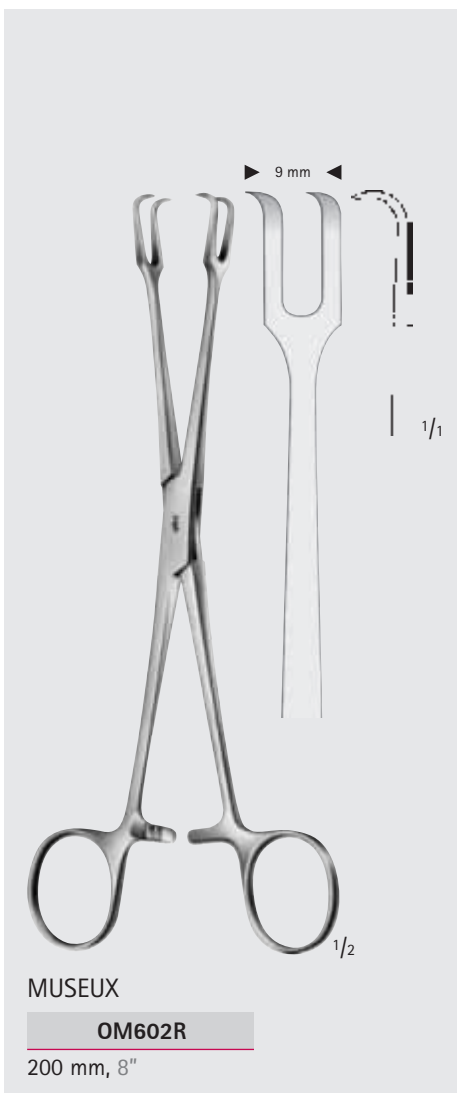

Korn- und Tupferzangen – Sponge- and Dressing Forceps

Organ- und Gewebefasszangen

Organ- and Tissue Grasping Forceps

BF

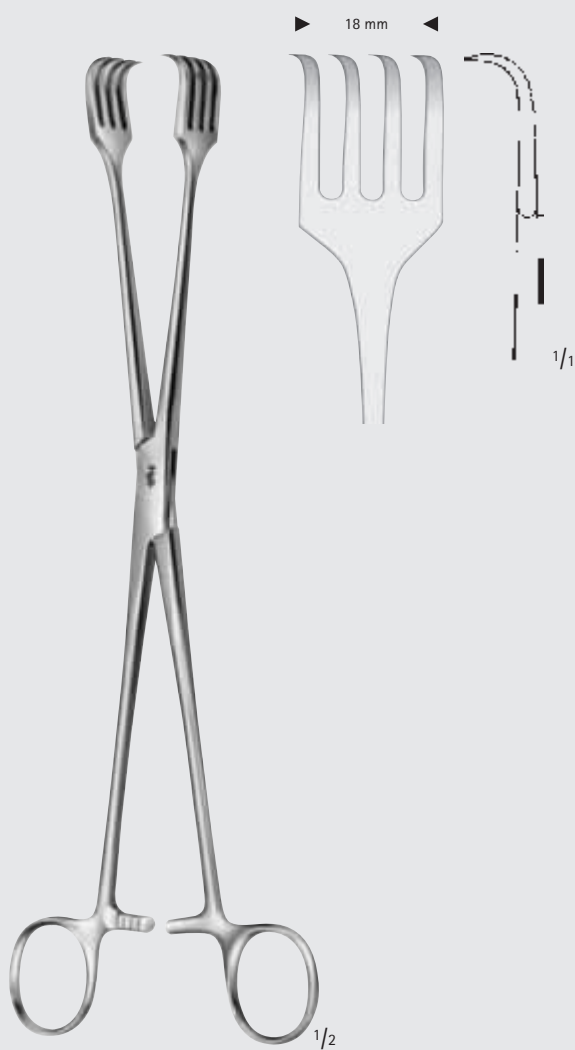

AESCULAP-PRATT

EO165R

260 mm, 10 1/4"



PRATT

EO166R

270 mm, 10 3/4"



Korn- und Tupferzangen – Sponge- and Dressing Forceps Organ- und Gewebefasszangen Organ- and Tissue Grasping Forceps

BF

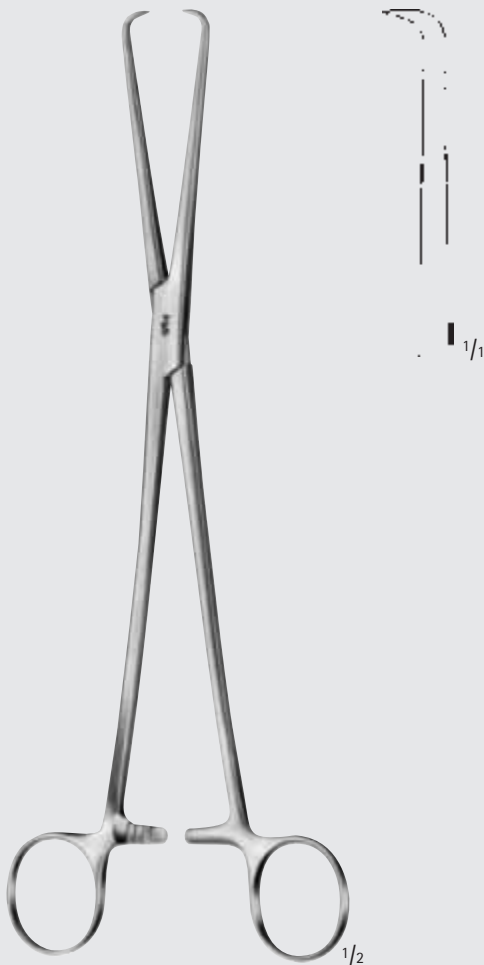

SCHRÖDER

EO110R

250 mm, 10"



WILSON

EO112R

240 mm, 9 1/2"



MILLIMETERS

Korn- und Tupferzangen – Sponge- and Dressing Forceps

Fremdkörperzangen

Foreign Body Forceps

BF



1/1

1/2

PITHA

EF921R

220 mm, 8 3/4"

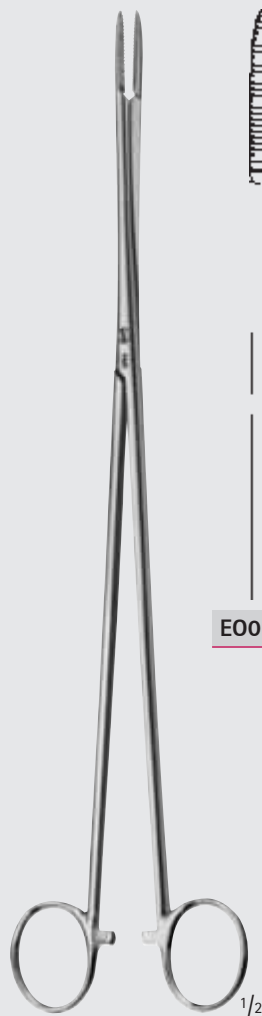

1/1

EO060R

EO061R

1/2

PELKMANN

EO060R-EO061R

260 mm, 10 1/4"



Korn- und Tupferzangen – Sponge- and Dressing Forceps

Tuchklemmen
Towel Clamps

BF

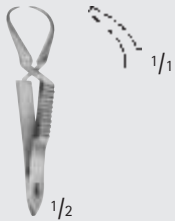

BF401R

55 mm, 2 1/8"

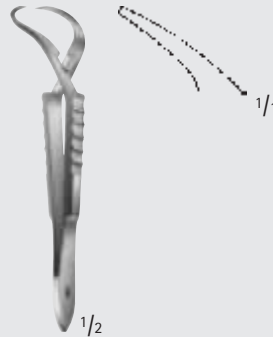

JONES

BF407R

85 mm, 3 3/8"



ENGL.MOD.

BF408R

85 mm, 3 3/8"

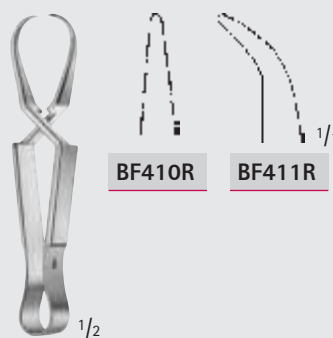

SCHAEDEL

BF410R-BF411R

85 mm, 3 3/8"



MILLIMETERS

Korn- und Tupferzangen – Sponge- and Dressing Forceps

Tuchklemmen

Towel Clamps

BF

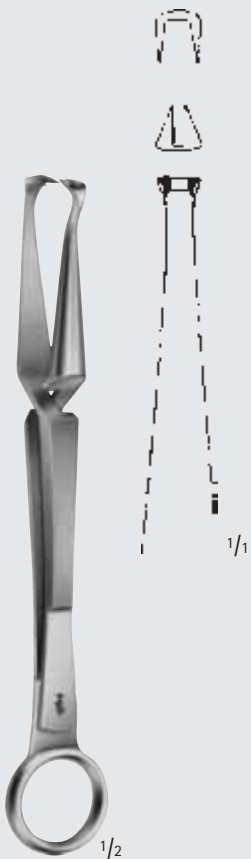

DOYEN

BF417R

180 mm, 7"

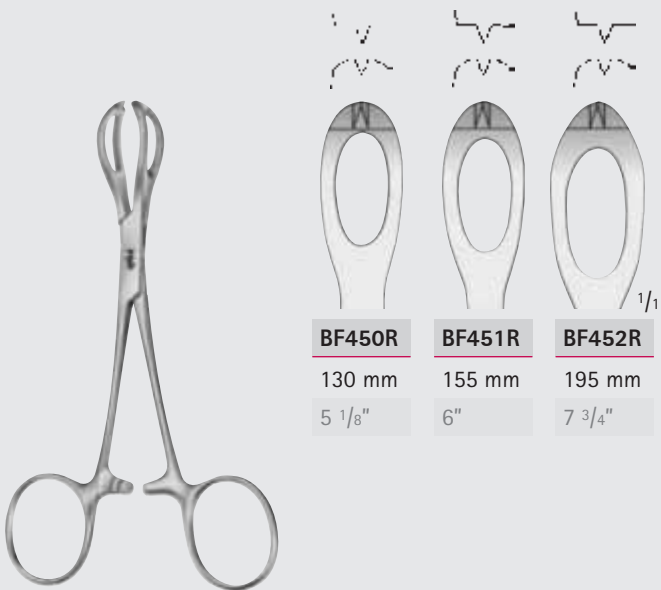

BF450R

130 mm

5 1/8"

BF451R

155 mm

6"

BF452R

195 mm

7 3/4"

LANE

BF450R-BF452R



Korn- und Tupferzangen – Sponge- and Dressing Forceps

Tuchklemmen
Towel Clamps

BF

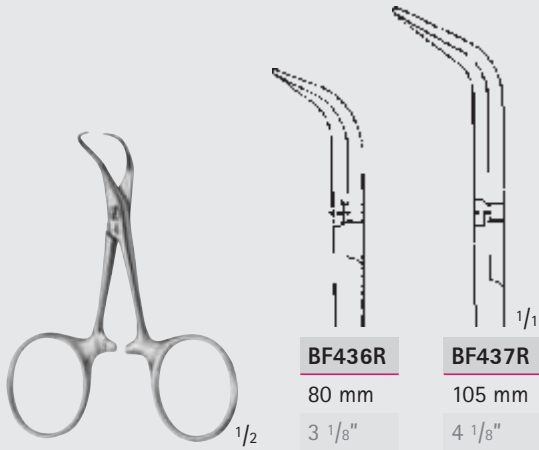

BF436R

80 mm

3 1/8"

BF437R

105 mm

4 1/8"

BACKHAUS

BF436R-BF437R

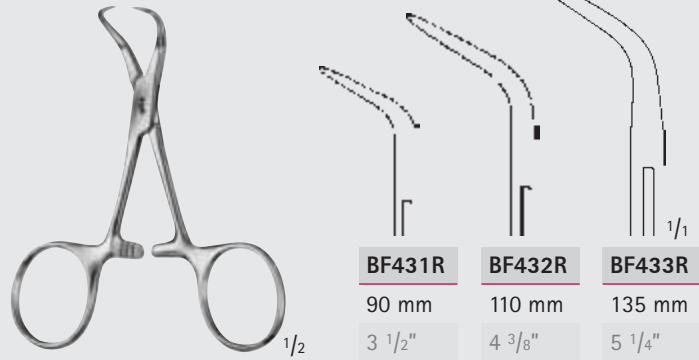

BF431R

90 mm

3 1/2"

BF432R

110 mm

4 3/8"

BF433R

135 mm

5 1/4"

BACKHAUS

BF431R-BF433R

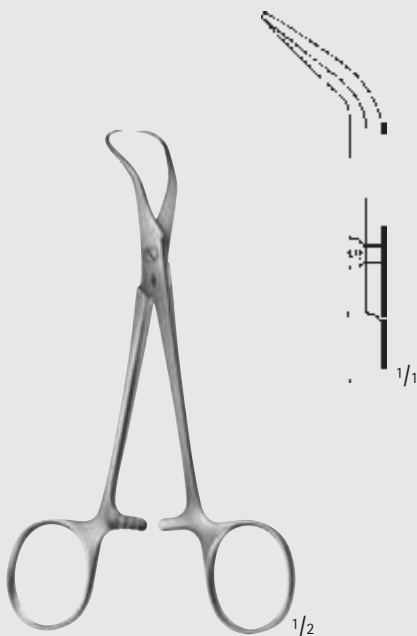

BACKHAUS-KOCHER

BF444R

135 mm, 5 1/4"

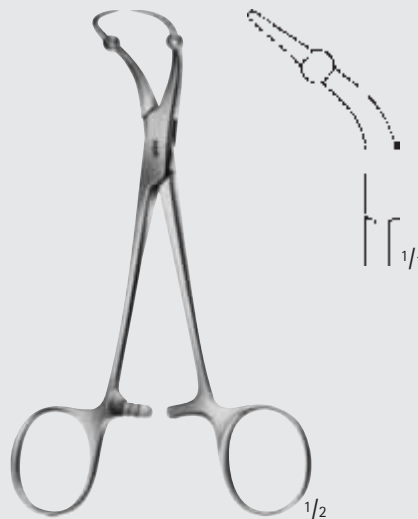

ROEDER

BF448R

135 mm, 5 1/4"

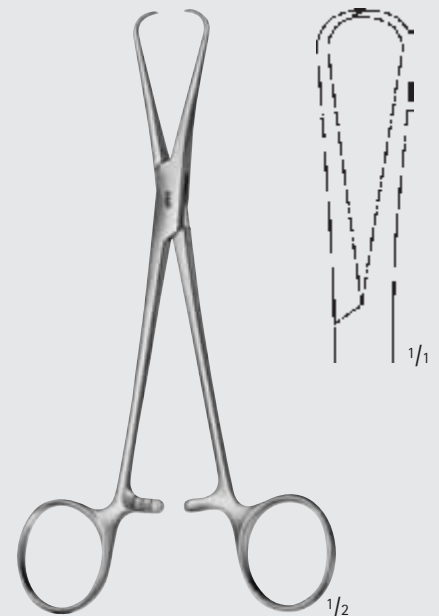

BERNHARD

BF426R

160 mm, 6 1/4"



MILLIMETERS

Korn- und Tupferzangen – Sponge- and Dressing Forceps

Tuchklemmen

Towel Clamps

BF



ROBIN

BF439R

mit Kabelhalterung bis 5 mm
Kabelstärke
with holders for cable up to 5 mm
135 mm, 5 1/4"

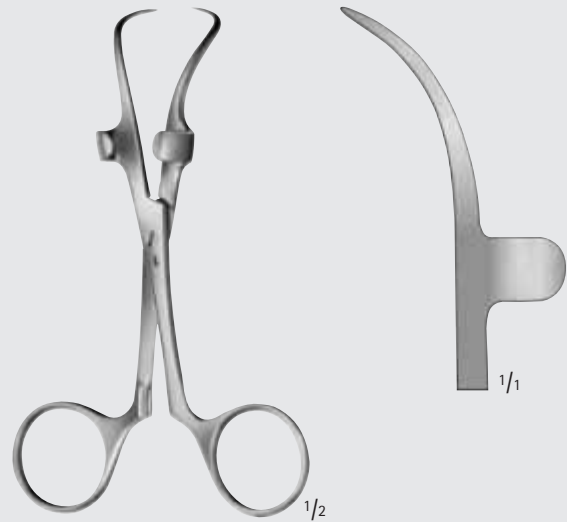

ROBIN

BF440R

mit Schlauchhalterung bis 13 mm
Schlauchstärke
with holders for tubing up to 13 mm
135 mm, 5 1/4"

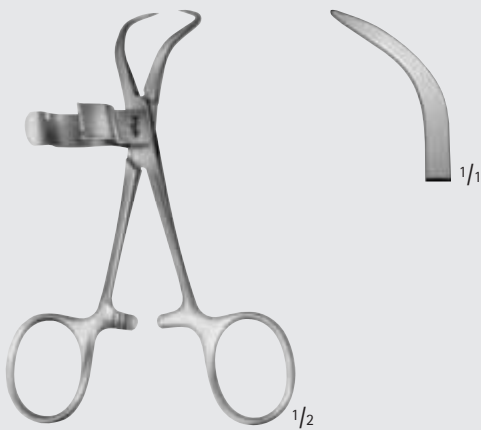

BF442R

mit Schlauchhalterung bis
15 mm Schlauchstärke
with holders for tubing up to 15 mm
110 mm, 4 3/8"

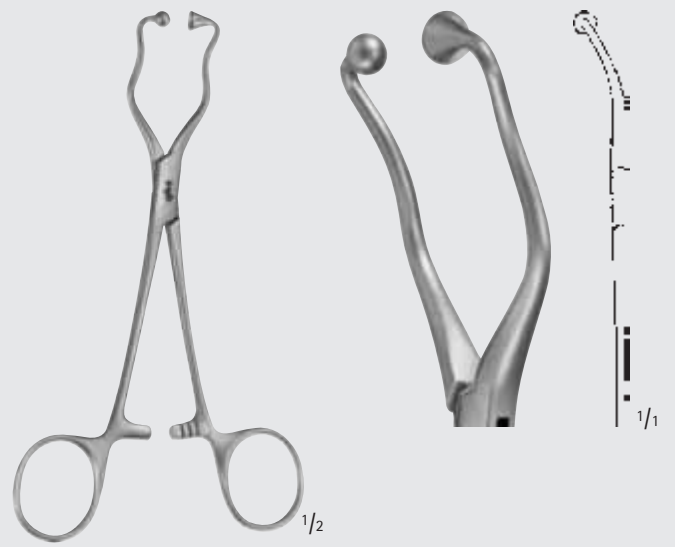

BF443R

Doppelschlauch-Fixierklemme
atraumatische Fassfläche
Tube fixation forceps with
atraumatic jaw parts
140 mm, 5 1/2"

Besonders geeignet für HLM-
Schläuche in der Herzchirurgie
Especially suitable for HLM
tubes for cardiovascular surgery



Korn- und Tupferzangen – Sponge- and Dressing Forceps

Tuchklemmen
Towel Clamps

BF

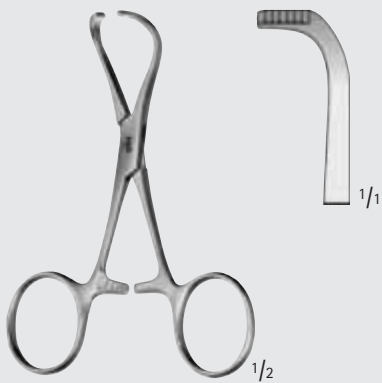

LORNA

BF461R

nicht perforierend
non-perforating
95 mm, 3 3/4"

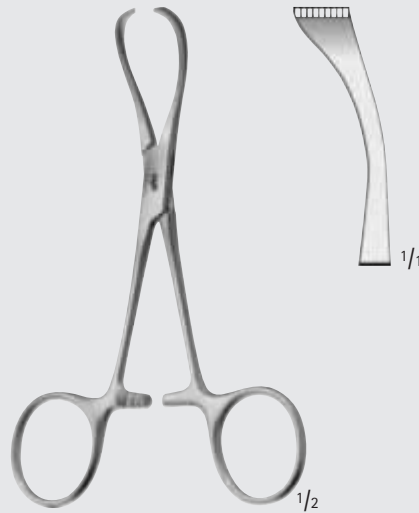

LORNA

BF463R

nicht perforierend
non-perforating
130 mm, 5 1/8"

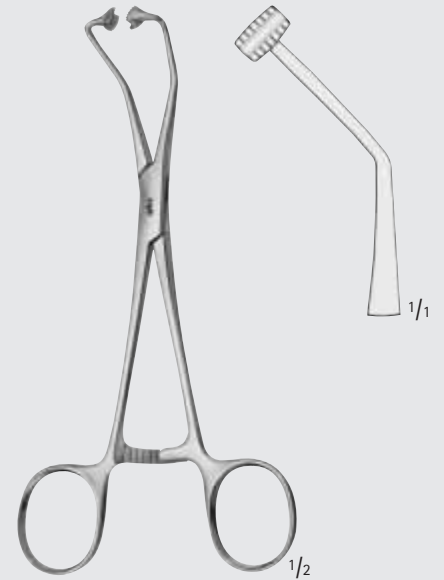

BF460R

für Papiertücher
for paper cloths
150 mm, 6"

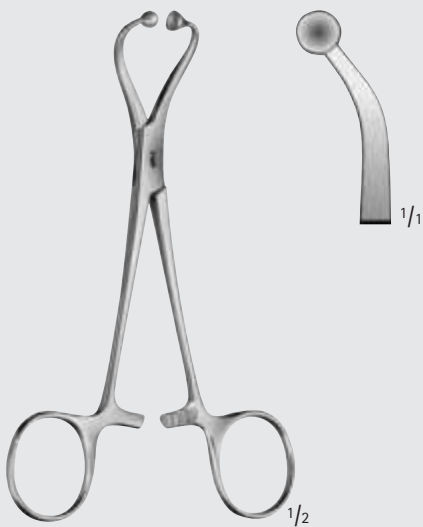

BF464R

für Papiertücher
for paper cloths
140 mm, 5 1/2"

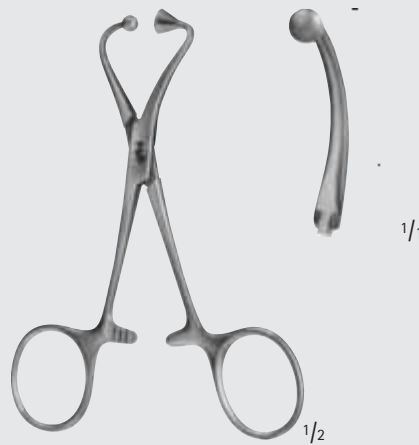

BF465R

für Papiertücher
for paper cloths
115 mm, 4 1/2"

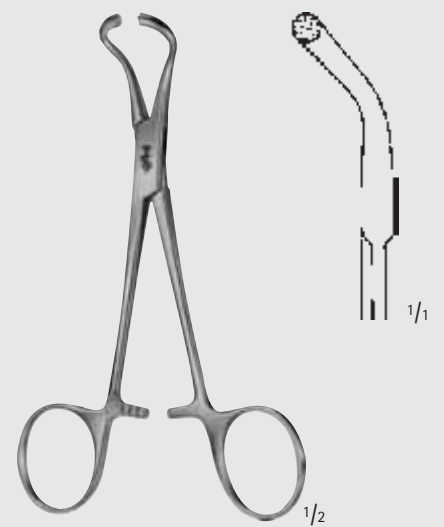

BF466R

für Papiertücher
for towel cloths
135 mm, 5 1/4"

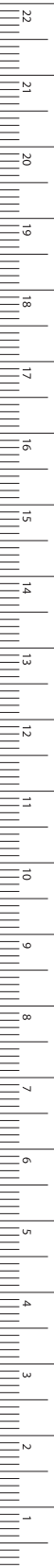

MILLIMETERS

Korn- und Tupferzangen – Sponge- and Dressing Forceps

Tuchklemmen

Towel Clamps

BF

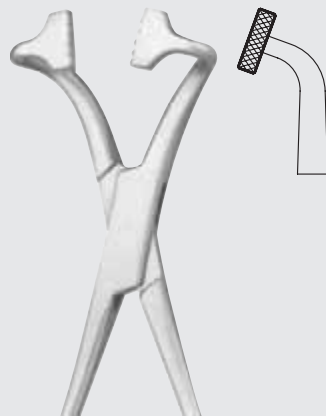

BF458R

100 mm

4"

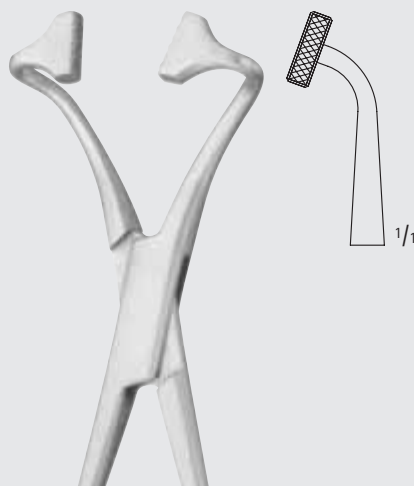

BF459R

135 mm

5 1/4"

BF458R-BF459R

nicht perforierend
non-perforating



Korn- und Tupferzangen – Sponge- and Dressing Forceps Sterilisierklammern für Ringgriff-Instrumente Safety Pins for Holding Ring Handle Instruments

BF



BUNT

BF491R

105 mm, 4 1/8"



MAYO

BF493R

140 mm, 5 1/2"

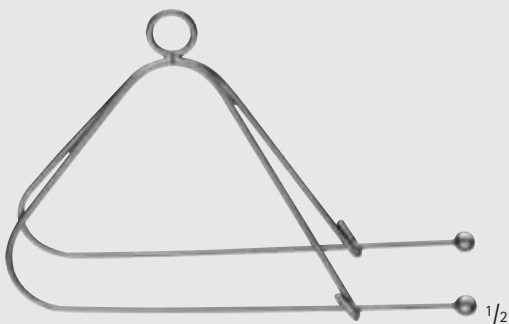

MAYO

BF494R

doppelt

double

125 mm, 5"

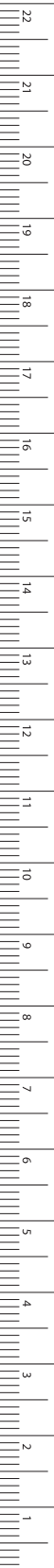

MILLIMETERS

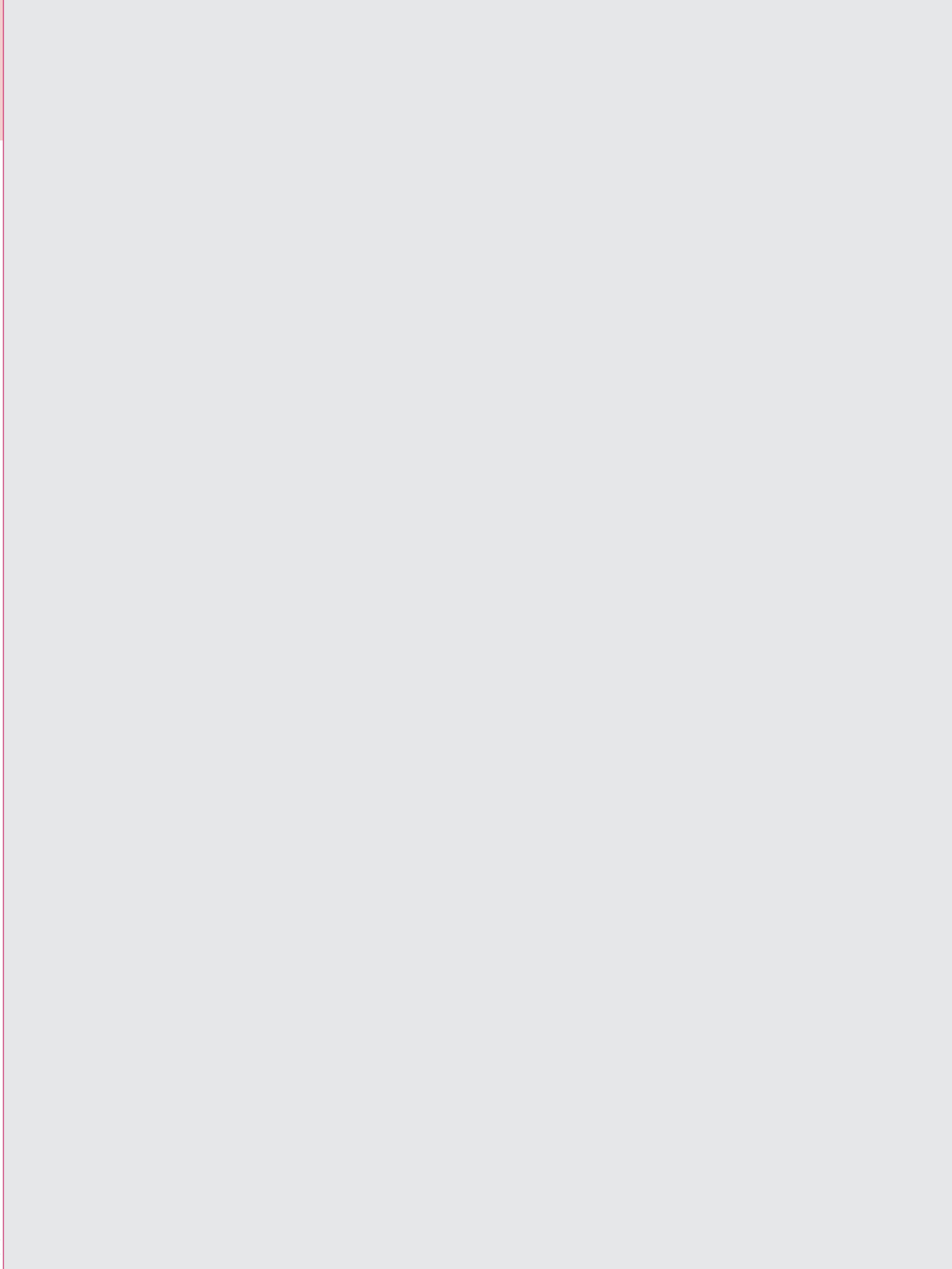

BH



Arterienklemmen, Bulldogklemmen,
Gefäßclips, Approximatoren
Haemostatic Forceps, Bulldog Clamps,
Vessel Clips, Approximators

Arterienklemmen – Hemostatic Forceps

Gefäßclips nach BIEMER, Gefäßclips nach MEHDORN, Minigröße
BIEMER Vessel Clips, MEHDORN Vessel Clips, Mini Size

für temporären Gebrauch

- Maulinnenflächen schräg gerieft, für schonendes, sicheres Festhalten der Gefäße.
- Der fest eingestellte Schließdruck gewährt risikofreie Anwendung.
- Schließkraft-Ermittlung: bei $\frac{1}{3}$ der Gesamtauflänge von vorn und einer Maulöffnung von 1 mm (siehe Zeichnung)

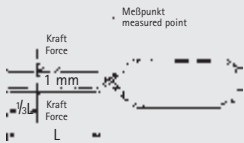

for temporary occlusion

- Blade gripping surface with oblique serrations for safe but careful gripping of vessels.
- No risk due to rigidly fixed pressure measure guarantees application without any risk.
- Closing force is measured at $\frac{1}{3}$ of the blades at 1 mm opening (see illustration).

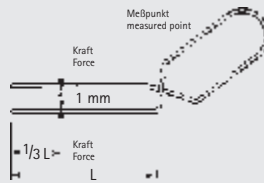

BIEMER

	Maul- öffnung Jaw opening	Maul- länge Jaw length	Schließkraft Closing force	Anlege- pinzette Applying forceps
FD560R	4 mm	6 mm	30 - 40 g (0,29 - 0,39 N)	FD568R oder / or FD569R
FD561R	5 mm	9 mm	30 - 40 g (0,29 - 0,39 N)	
FD562R	5 mm	9 mm	20 - 25 g (0,20 - 0,25 N)	

(gekennzeichnet durch gelb gefärbte Federenden)
für Gefäße mit \varnothing 0,5 - 2,0 mm.

(identified by yellow colored spring ends)
for vessels diam. 0.5 - 2.0 mm.

MEHDORN

	Maul- öffnung Jaw opening	Maul- länge Jaw length	Schließkraft Closing force	Anlege- pinzette Applying forceps
FD552R	4 mm	1,0 mm	10 - 15 g (0,10 - 0,15 N)	FD578R
FD554R	4 mm	1,4 mm	15 - 20 g (0,15 - 0,20 N)	
FD556R	6 mm	1,0 mm	10 - 15 g (0,10 - 0,15 N)	
FD558R	6 mm	1,4 mm	15 - 20 g (0,15 - 0,20 N)	

(gekennzeichnet durch gelb eingefärbte Federenden)
für Gefäße mit \varnothing 0,5 - 1,5 mm (extra-intracraniale Anastomosen).

(identified by yellow colored spring ends)
for vessels diam. 0.5 - 1.5 mm (extra-intercranial anastomosis).

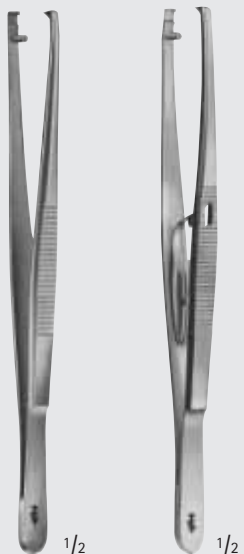

FD568R

ohne Schloss
without lock

FD569R

mit Schloss
with lock

BIEMER

FD568R-FD569R

Anlegepinzetten für Gefäßclips
nach BIEMER und Approximatoren
nach BIEMER-MÜLLER und MÜLLER

Applying forceps for BIEMER vessel
clips and BIEMER-MÜLLER and
MÜLLER approximators

140 mm, 5 1/2"

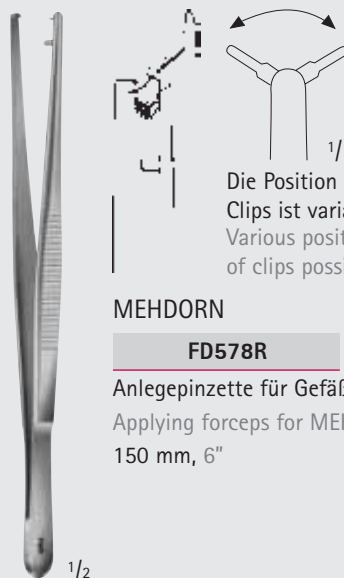

MEHDORN

FD578R

Anlegepinzette für Gefäßclips nach MEHDORN

Applying forceps for MEHDORN vessel clips
150 mm, 6"



Arterienklemmen – Hemostatic Forceps

Approximatoren, nach BIEMER-MÜLLER, BIEMER BIEMER-MÜLLER, BIEMER Approximators





für Mikro-Gefäßanastomosen im oberflächlichen Bereich

- Maulinnenflächen schräg gerieft, für schonendes, sicheres Festhalten der Gefäßenden.
- Der fest eingestellte Schließdruck garantiert risikofreie Anwendung.
- Der Abstand zwischen den Clips ist durch einfaches Verschieben variabel und wird durch Verkantung selbsttätig fixiert.
- Die leichte Konstruktion (geringes Gewicht, kleine Dimension) ermöglicht im angelegten Zustand einfaches, verzerrungsfreies Umdrehen, um auf der unteren Gefäßseite weiterzunähen.

for micro vessel anastomosis in the superficial range

- Blade gripping surface with oblique serrations for careful but safe holding of the vessel ends.
- No risk due to rigidly fixed pressure measure.
- Adjustable distance between the clips and automatic fixation by tilting.
- Even when applied, the lightweight construction allows easy, distortionless turning and makes suturing possible on the other side of the vessel.

BIEMER-MÜLLER

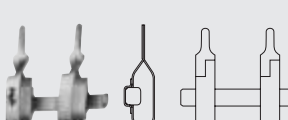
Mikro-Approximatoren Micro approximators	Maul- öffnung Jaw opening	Maul- länge Jaw length	Schließkraft Closing force	Anlege- pinzette Applying forceps
FD611R 	5 mm	9 mm	25 - 30 g (0,25 - 0,29 N)	FD568R oder / or FD569R
FD612R 	5 mm	9 mm	25 - 30 g (0,25 - 0,29 N)	
FD613R 	5 mm	9 mm	25 - 30 g (0,25 - 0,29 N)	
FD614R 	5 mm	9 mm	25 - 30 g (0,25 - 0,29 N)	
FD615R 	3 mm	4,5 mm	25 - 30 g (0,25 - 0,29 N)	

BIEMER

FD571R 	4 mm	6 mm	30 - 40 g (0,29 - 0,39 N)	FD572R
---	------	------	------------------------------	---------------

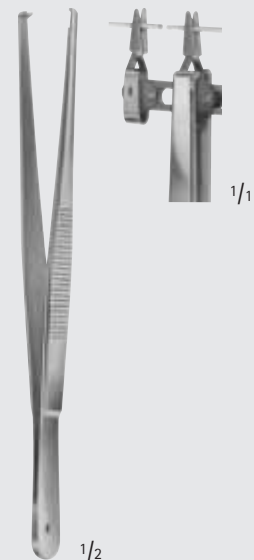

BIEMER

FD572R

Anlegepinzette für Gefäß-
Approximator nach BIEMER
Applying forceps for BIEMER
vessel approximator
145 mm, 5 3/4"



Arterienklemmen – Hemostatic Forceps

Approximator, Nerv-Approximator nach BIEMER

Approximator, BIEMER Approximator for Nerves

für Mikro-Gefäßanastomosen im tieferen Bereich,
außerdem für experimentelle Chirurgie

- Maulinnenflächen schräg gerieft, für schonendes, sicheres Festhalten der Gefäßenden.
- Der Schließdruck wird mit dem Schlüssel FD576R eingestellt.
- Der Abstand zwischen den Clips ist variabel und wird mit dem Schlüssel FD576R fixiert.

for micro vessel anastomosis in the deeper range,
also for experimental surgery

- Blade gripping surface with oblique serrations for careful but safe holding of the vessel ends.
- The pressure measure is adjusted with key FD576R.
- The distance between the clips is variable and fixed with key FD576R.

zur sicheren Adaption bei Nervanastomosen

- Das Durchstrecken des Nervenzentrum mit feinen Nadeln verhindert stärkere pathologische Veränderungen.
- Nadeln mit Schlüssel FD576R austauschbar.
- Abstand zwischen den Nadeln variabel und mit Schlüssel FD576R fixierbar.

for safe adaption of nerve anastomoses

- Piercing the nerve centre with fine needles prevents strong pathological changes.
- Needles can be exchanged with key FD576R.
- Distance between the needles is variable and can be fixed with key FD576R.

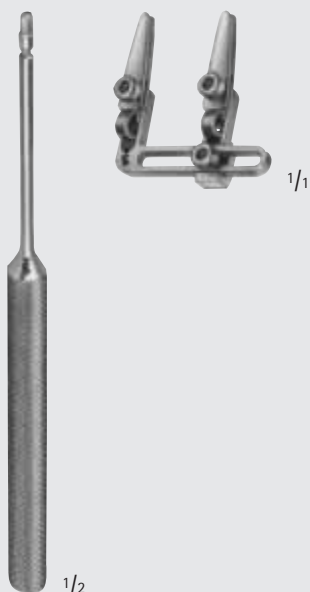

FD575R

Approximator komplett, mit
Schlüssel FD576R
Approximator complete,
with key FD576R

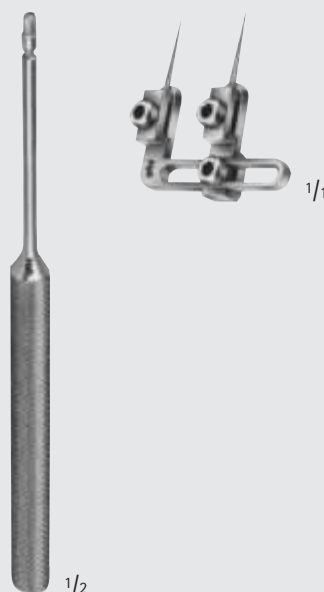

BIEMER

FD635R

Nerv-Approximator kom-
plett, mit Schlüssel FD576R

Approximator for nerves
complete, with key FD576R

FD636R

1 Paar Ersatznadeln
1 pair of spare needles



Arterienklemmen – Hemostatic Forceps

Gefäßclips
Vessel Clips

BH



Schließdruck Closing force					
50 g	FE010K	FE011K	FE012K	FE013K	FE014K
80 g	FE020K	FE021K	FE022K	FE023K	FE024K
	gerade straight	gebogen curved	Spitze gebogen curved tips	zur Seite abgewinkelt angled to side	kniegebogen knee-bent

MÜLLER

FE010K-FE024K

Temporäre Gefäßclips mit atraumatischem Maulprofil
Non-traumatic vessel clips, temporary



1/1
Maulprofil fein kariert
jaw profiles, finally
cross-serrated

MÜLLER

FE005K

Fadenklemme
Ligature Forceps

MILLIMETERS

Arterienklemmen – Hemostatic Forceps

Gefäßclips

Vascular Clips

DE BAKEY Zahnung

Toothing DE BAKEY

Gefäßclips nach MÜLLER

Merkmale:

- Atraumatisches Maulprofil
- Beidseitig angebrachte Griffplateaus zum sicheren Anlegen und Abnehmen des Clips.
- Exakt definierter Schließdruck für arterielle und venöse Gefäße.
- Gefäßclips eindeutig mit Schließdruck gekennzeichnet.
- Geschlossener Maulkasten zur sicheren Maulführung. Kein ungewolltes Verfangen des Fadens möglich.

MÜLLER Vascular Clips

Features:

- Atraumatic mouth profile
- Handle plateau mounted on both sides for secure application and removal of the clip.
- Exactly defined closing pressure for arterial and venous vessels.
- Vascular clips are clearly marked with closing pressure.
- Closed mouth box guarantees precise guidance of the working tips. No risk of threads getting tangled up in clip.

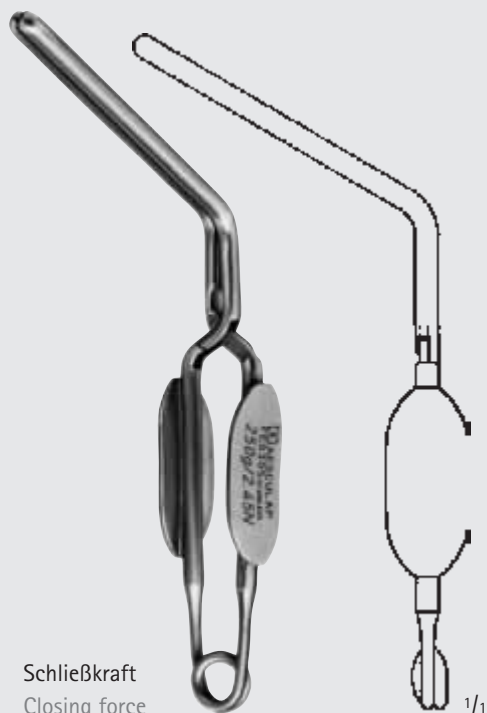

Schließkraft
Closing force

MÜLLER

250 g **FE030S**

350 g **FE040S**

gerade
straight

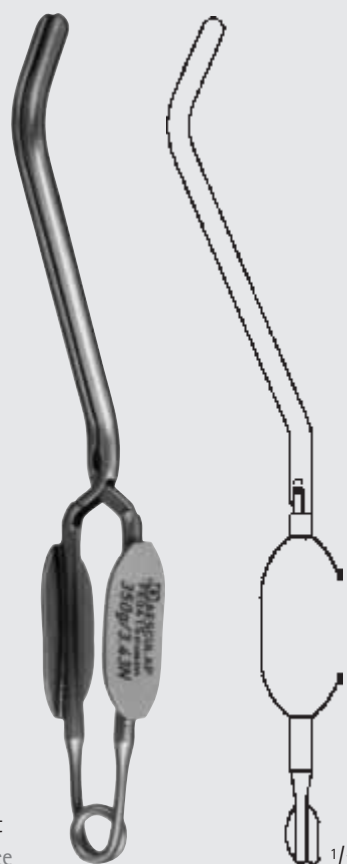

Schließkraft
Closing force

MÜLLER

250 g **FE031S**

350 g **FE041S**

gebogen
curved



DE BAKEY Zahnung

Toothing DE BAKEY

Arterienklemmen – Hemostatic Forceps

Gefäßclips

Vascular Clips

BH

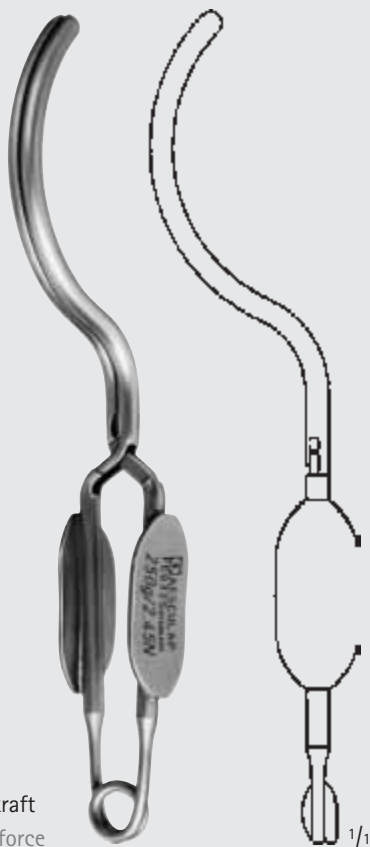

Schließkraft
Closing force

MÜLLER

250 g **FE032S**

350 g **FE042S**

Spitze gebogen
curved tips

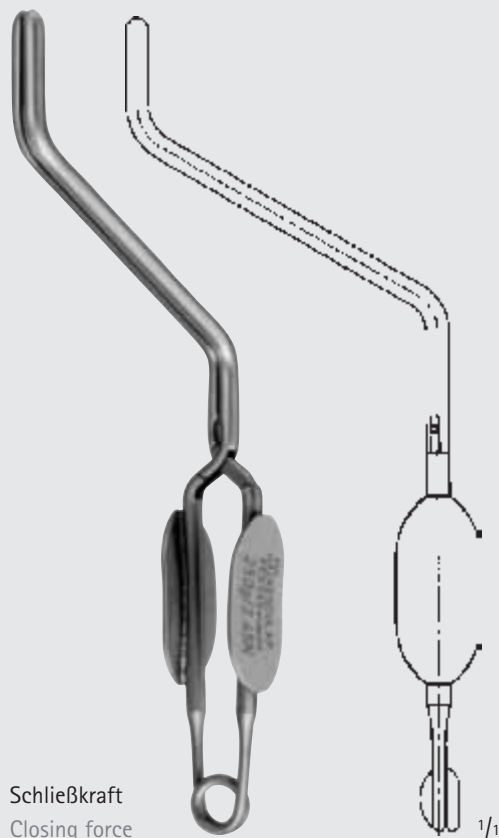

Schließkraft
Closing force

MÜLLER

250 g **FE034S**

350 g **FE044S**

kniegebogen
knee-bent

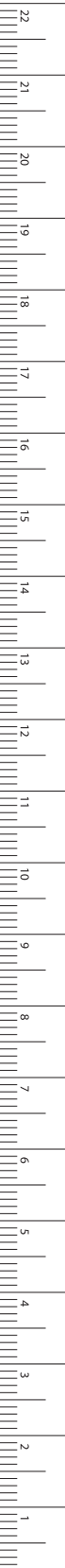

MILLIMETERS

Arterienklemmen – Hemostatic Forceps

Bulldogklemmen

Bulldog Clamps

BH



JOHNS-HOPKINS

BH018R

Zange zum Anlegen und Abnehmen der Bulldogklemmen BH011R - BH031R und FB420R - FB427R

Forceps for applying and removing bulldog clamps BH011R - BH031R and FB420R - FB427R

240 mm, 9 3/4"

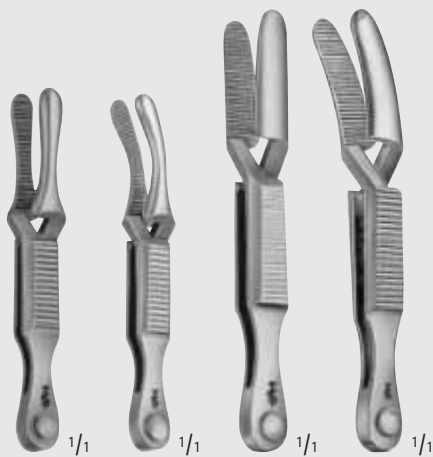

BH020R **BH021R** **BH026R** **BH027R**
BH022R **BH023R**

DIEFFENBACH

Gesamtlänge: Maullänge:
 Total length: Jaw length:

BH020R	38 mm, 1 1/2"	12 mm, 1/2"
BH022R	48 mm, 2"	16 mm, 5/8"
BH021R	38 mm, 1 1/2"	12 mm, 1/2"
BH023R	48 mm, 2"	16 mm, 5/8"
BH026R	58 mm, 2 1/8"	16 mm, 5/8"
BH027R	58 mm, 2 1/8"	16 mm, 5/8"



BH011R-BH017R

JOHNS-HOPKINS

Gesamtlänge Maullänge:
 Total length: Jaw length:

BH011R	38 mm, 1 1/2"	12 mm, 1/2"
BH012R	48 mm, 2"	17 mm, 5/8"
BH013R	56 mm, 2 1/8"	25 mm, 1"
BH014R	63 mm, 2 1/2"	30 mm, 1 3/16"
BH015R	70 mm, 2 3/4"	33 mm, 1 1/4"
BH016R	80 mm, 3 1/8"	42 mm, 1 3/4"
BH017R	91 mm, 3 1/2"	52 mm, 2"



Arterienklemmen – Hemostatic Forceps

Bulldogklemmen

Bulldog Clamps

BH



1/1

DE BAKEY-HESS

BH030R

Gesamtlänge: 34 mm
 Total length: 1 3/8"
 Maullänge: 20 mm
 Jaw length: 3/4"



FB328R

Gesamtlänge: 35 mm
 Total length: 1 3/8"
 Maullänge: 14 mm
 Jaw length: 1/2"



FB329R

Gesamtlänge: 35 mm
 Total length: 1 3/8"
 Maullänge: 14 mm
 Jaw length: 1/2"



FB330R

Gesamtlänge: 45 mm
 Total length: 1 3/4"
 Maullänge: 19 mm
 Jaw length: 3/4"



1/1

FB331R

Gesamtlänge: 45 mm
 Total length: 1 3/4"
 Maullänge: 19 mm
 Jaw length: 3/4"



1/1

DE BAKEY-HESS

BH031R

Gesamtlänge: 43 mm
 Total length: 1 7/10"
 Maullänge: 30 mm
 Jaw length: 1 3/16"



DIETHRICH

MB285R

Gesamtlänge: 55 mm
 Total length: 2 1/8"
 Maullänge: 13 mm
 Jaw length: 1/2"



DIETHRICH

BH032R

Gesamtlänge: 48 mm
 Total length: 1 7/8"
 Maullänge: 10 mm
 Jaw length: 3/8"



1/1

DIETHRICH

BH034R

Gesamtlänge: 48 mm
 Total length: 1 7/8"
 Maullänge: 13 mm
 Jaw length: 1/2"



MILLIMETERS

Arterienklemmen – Hemostatic Forceps

Bulldogklemmen
Bulldog Clamps

DE BAKEY Zahnung

AIRAUMATA®

Toothing DE BAKEY

Mini-Bulldogklemmen
Schließdruck 180 g
Mini-bulldog clamps
Closing force 180 g

gerade
straight



gewinkelt, 55°
angled, 55°

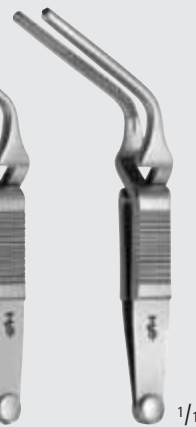
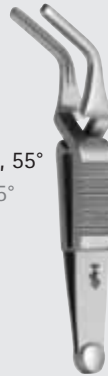

curved
gebogen



	FB362R	FB364R	FB366R	FB363R	FB365R	FB367R	FB369R
Gesamtlänge:	50 mm	55 mm	60 mm	50 mm	50 mm	55 mm	55 mm
Total length:	2"	2 1/8"	2 3/8"	2"	2"	2 1/8"	2 1/8"
Maullänge:	10 mm	14 mm	20 mm	10 mm	14 mm	20 mm	20 mm
Jaw length:	3/8"	1/2"	3/4"	3/8"	1/2"	3/4"	3/4"



	DE BAKEY	DE BAKEY	GLOVER	DE BAKEY	DE BAKEY	DE BAKEY
	FB352R	FB353R	FB431R	FB357R	FB358R	FB359R
Gesamtlänge:	50 mm	48 mm	52 mm	73 mm	99 mm	95 mm
Total length:	2"	2"	2"	2 3/4"	4"	3 1/2"
Maullänge:	27 mm	27 mm	35 mm	38 mm	63 mm	54 mm
Jaw length:	1 1/8"	1 1/8"	1 1/3"	1 1/2"	2 1/2"	2 1/8"

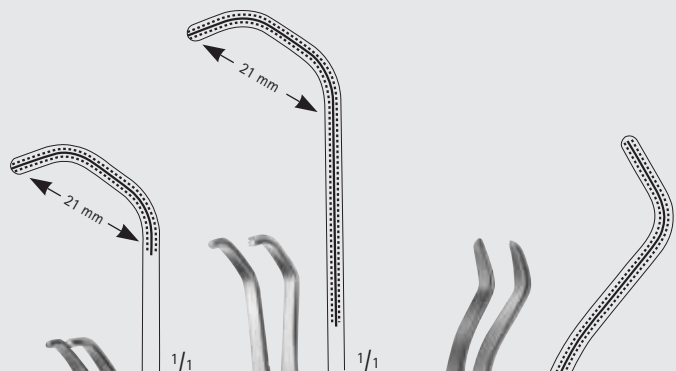

BH





DE BAKEY Zahnung

Arterienklemmen – Hemostatic Forceps

Bulldogklemmen

Bulldog Clamps

Toothing DE BAKEY

AIRAUMATA®

BH



DE BAKEY

FB420R

Gesamtlänge: 80 mm

Total length: 3 1/8"

Maullänge: 25 mm

Length of jaw: 1"

DE BAKEY

FB422R

90 mm

3 1/2"

35 mm

1 3/8"

DE BAKEY

FB424R

105 mm

4 1/8"

50 mm

2"

DE BAKEY

FB426R

124 mm

5"

68 mm

2 3/4"



DE BAKEY

FB421R

78 mm

3 1/8"

23 mm

1"

DE BAKEY

FB423R

86 mm

3 3/8"

31 mm

1 1/8"

DE BAKEY

FB425R

97 mm

3 3/4"

42 mm

1 3/4"

DE BAKEY

FB427R

114 mm

4 1/2"

58 mm

2 3/8"



GLOVER

FB432R

Gesamtlänge: 68 mm

Total length: 2 3/4"

Maullänge: 33 mm

Length of jaw: 1 3/8"

GLOVER

FB434R

96 mm

3 3/4"

50 mm

2"

GLOVER

FB436R

117 mm

4 3/4"

69 mm

2 3/4"



GLOVER

FB433R

65 mm

2 1/2"

33 mm

1 3/8"

GLOVER

FB435R

91 mm

3 1/2"

50 mm

2"

GLOVER

FB437R

110 mm

4 3/8"

69 mm

2 3/4"



MILLIMETERS

Arterienklemmen – Hemostatic Forceps

Feine Arterieklemmen

Delicate Hemostatic Forceps

BH

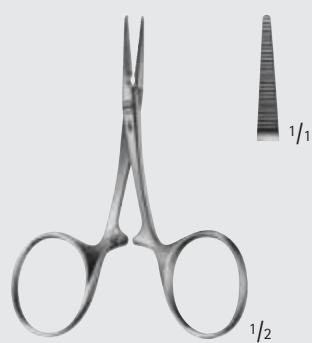

CARREL

BH100R

85 mm, 3 3/8"

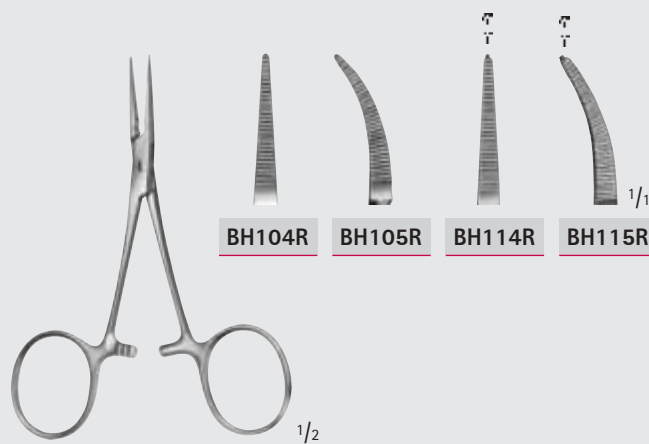

BABY-MOSQUITO
(HARTMANN)

BH104R-BH115R

100 mm, 4"

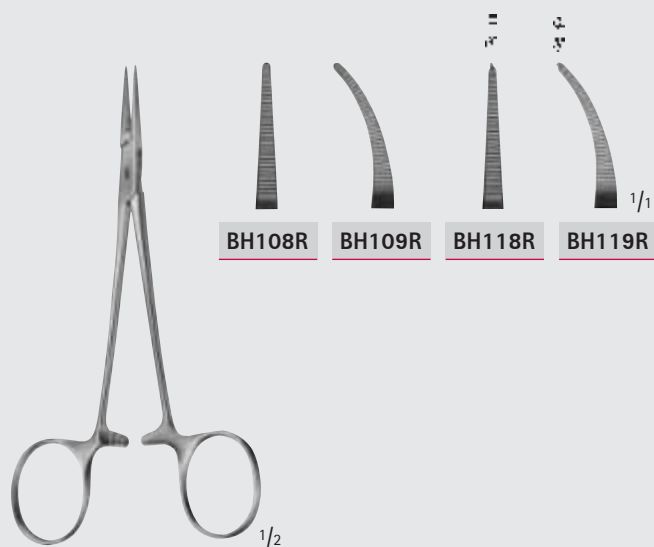

MICRO-HALSTED

BH108R-BH119R

125 mm, 5"

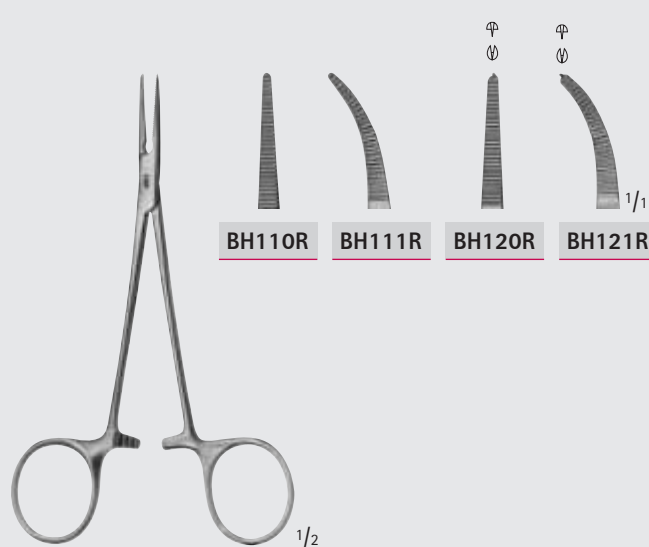

HALSTED-MOSQUITO

BH110R-BH121R

125 mm, 5"



Arterienklemmen – Hemostatic Forceps

Feine Arterienklemmen
Delicate Hemostatic Forceps

BH

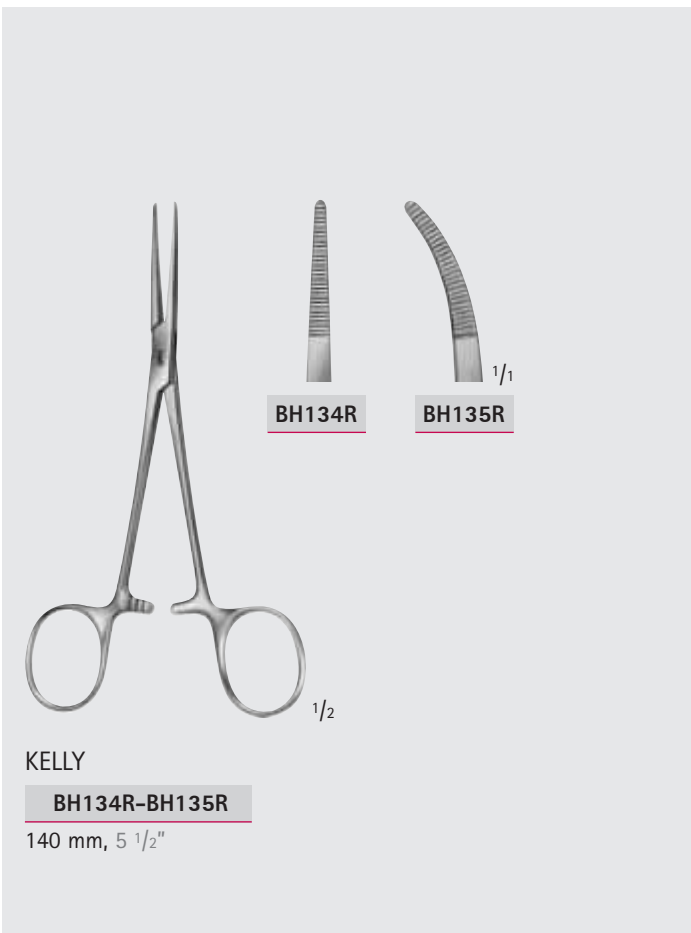
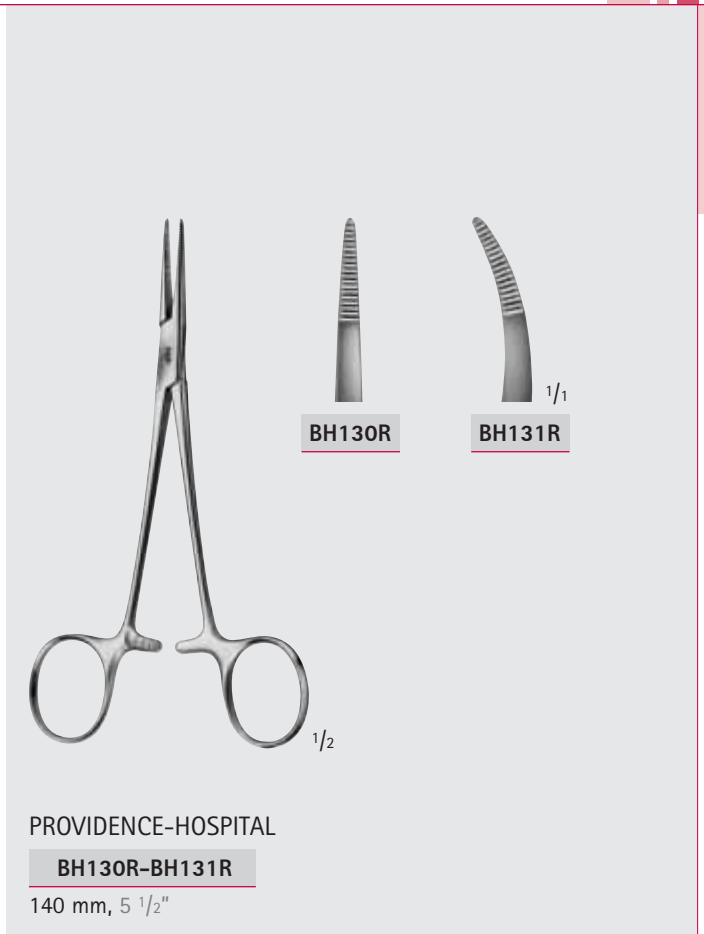
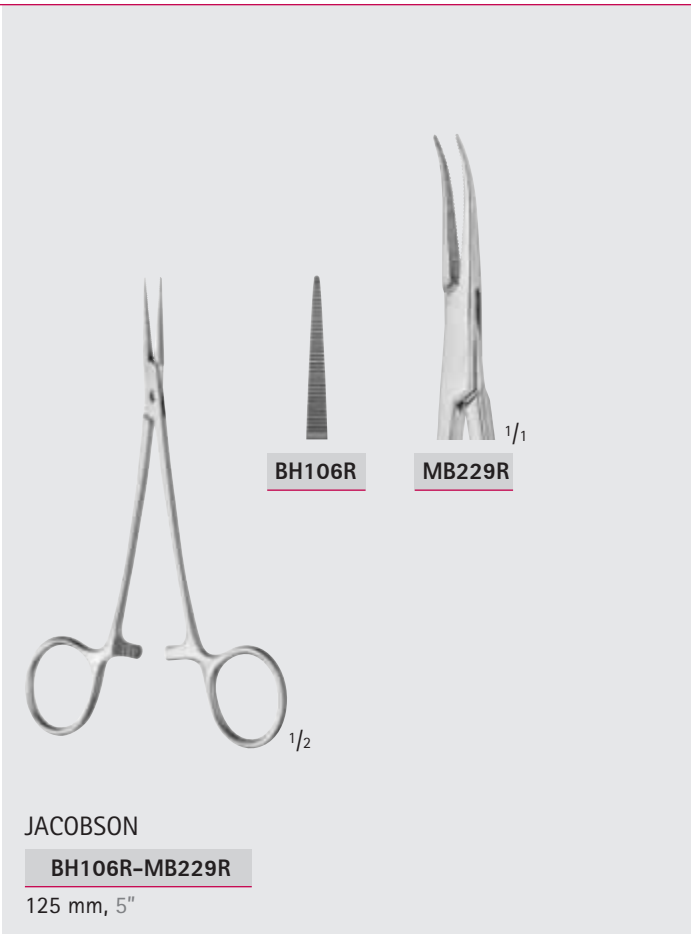

Arterienklemmen – Hemostatic Forceps

Feine Arterienklemmen

Delicate Hemostatic Forceps

BH

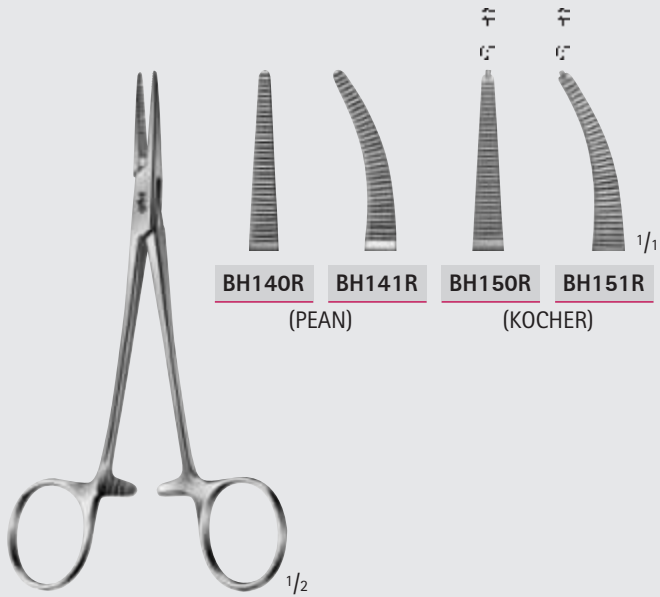

BH140R

BH141R

BH150R

BH151R

(PEAN)

(KOCHER)

BABY-CRILE

BH140R-BH151R

140 mm, 5 1/2"

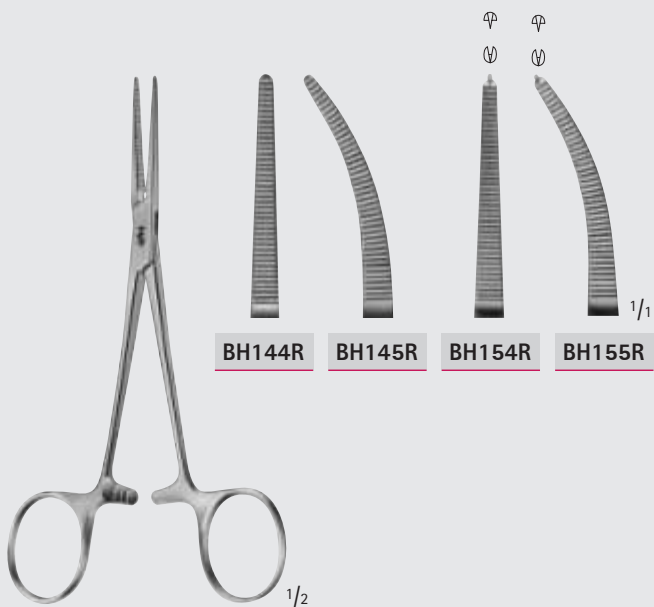

BH144R

BH145R

BH154R

BH155R

CRILE

BH144R-BH155R

140 mm, 5 1/2"



DUNHILL

BH123R

125 mm, 5"





Arterienklemmen – Hemostatic Forceps

Feine Arterienklemmen Delicate Hemostatic Forceps

BH



CAIRNS

BH124R-BH125R

150 mm, 6"

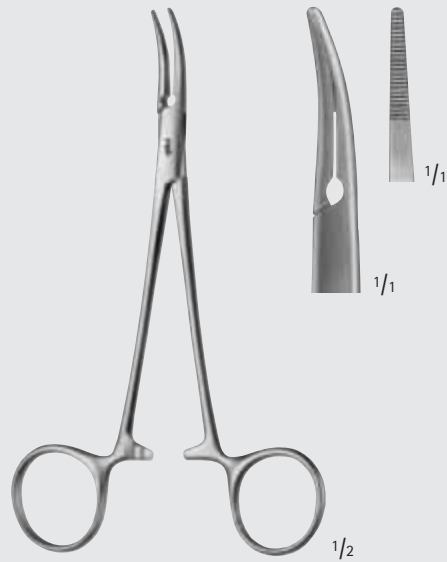

CAIRNS

BH126R

seitwärts gebogen
curved to side
145 mm, 5 3/4"

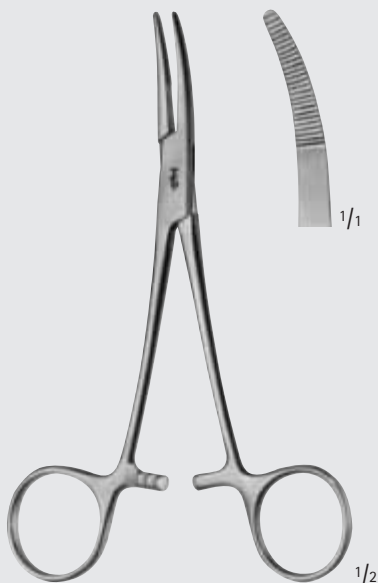

MOYNIHAN

BH127R

150 mm, 6"

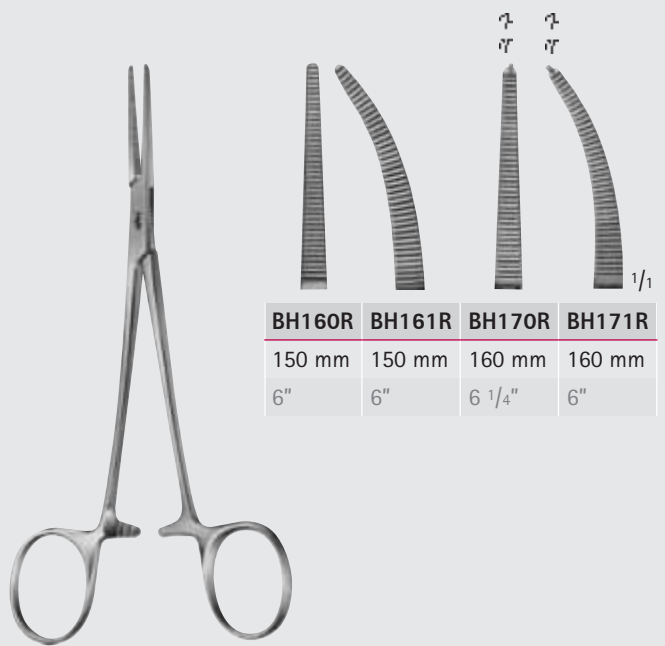

LERICHE

BH160R-BH171R

BH160R	BH161R	BH170R	BH171R
150 mm	150 mm	160 mm	160 mm
6"	6"	6 1/4"	6"



MILLIMETERS

Arterienklemmen – Hemostatic Forceps

Feine Arterienklemmen

Delicate Hemostatic Forceps

BH

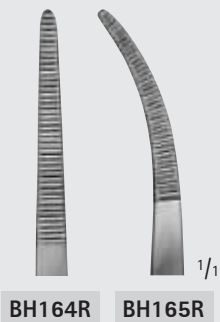

BH164R

BH165R

1/2

RANKIN

BH164R-BH165R

160 mm, 6 1/4"

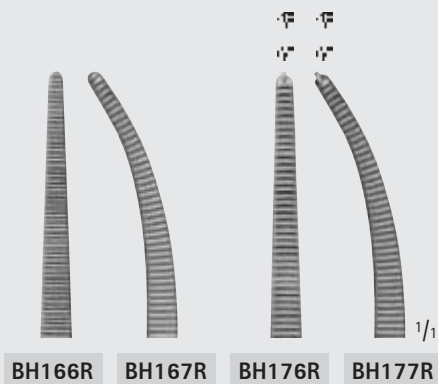

BH166R

BH167R

BH176R

BH177R

1/2

CRILE

BH166R-BH177R

160 mm, 6 1/4"

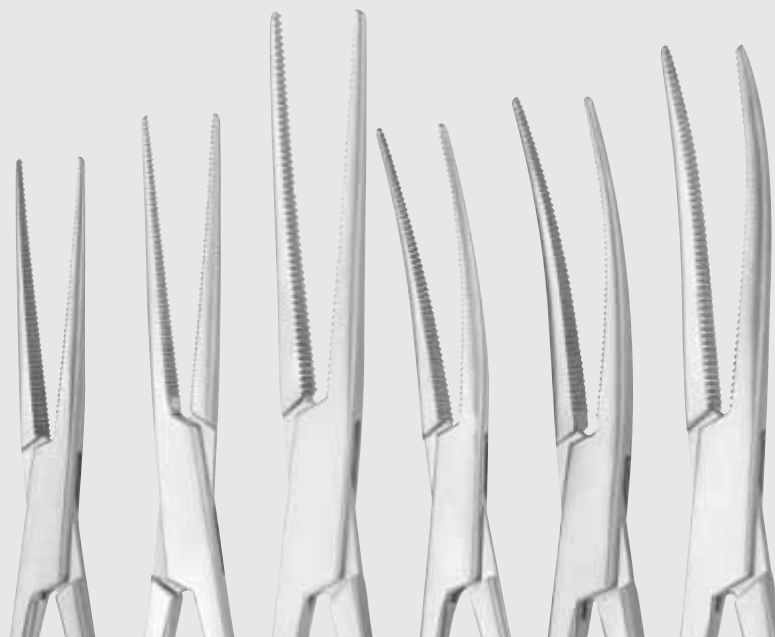

MD464

140 mm

5 1/2"

MD466R

165 mm

6 1/2"

MD468

185 mm

7 1/4"

MD465R

140 mm

5 1/2"

MD467R

165 mm

6 1/2"

MD469

185 mm

7 1/4"

COLLER

MD464-MD469



Arterienklemmen – Hemostatic Forceps
 Feine Arterienklemmen
 Delicate Hemostatic Forceps

BH

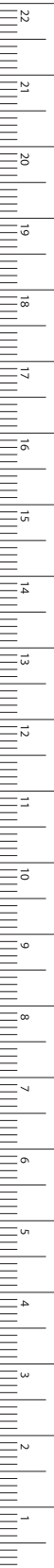

MILLIMETERS



BH168R

BH178R

1/2

DIXON-LOVELACE

BH168R-BH178R

160 mm, 6 1/4"



1/1

1/2

FUCHSIG

BH198R

195 mm, 7 3/4"



1/1

1/2

NISSEN

BH199R

185 mm, 7 1/4"



BH200R

BH201R

1/1

1/2

ADSON

BH200R-BH201R

185 mm, 7 1/4"

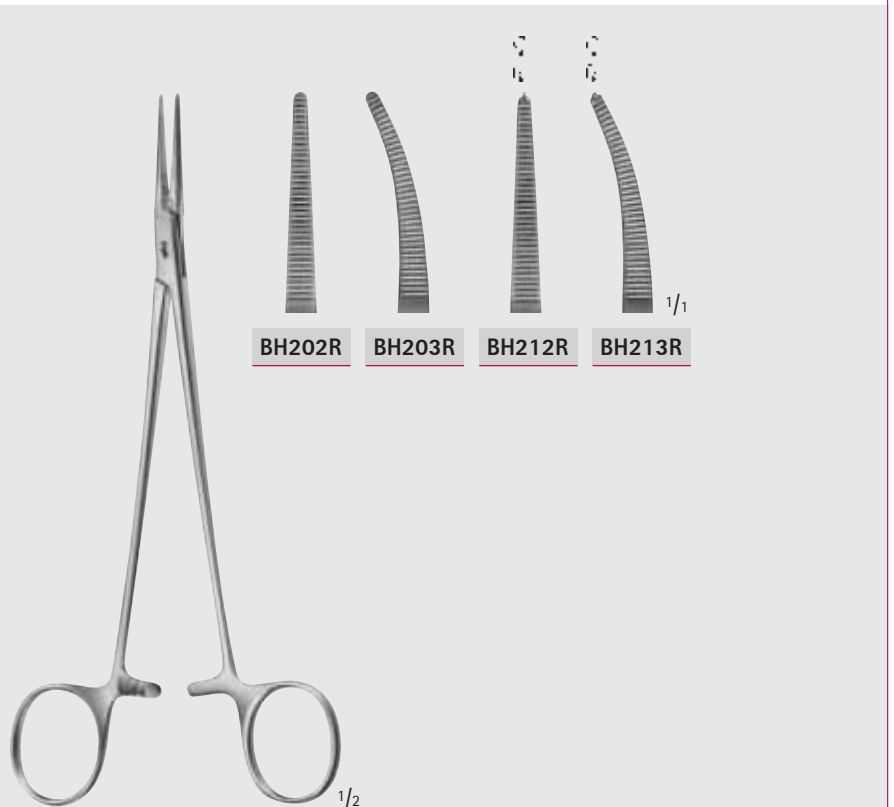

BH202R

BH203R

BH212R

BH213R

1/1

1/2

HALSTED

BH202R-BH213R

185 mm, 7 1/4"

Arterienklemmen – Hemostatic Forceps

Feine Arterienklemmen

Delicate Hemostatic Forceps

BH

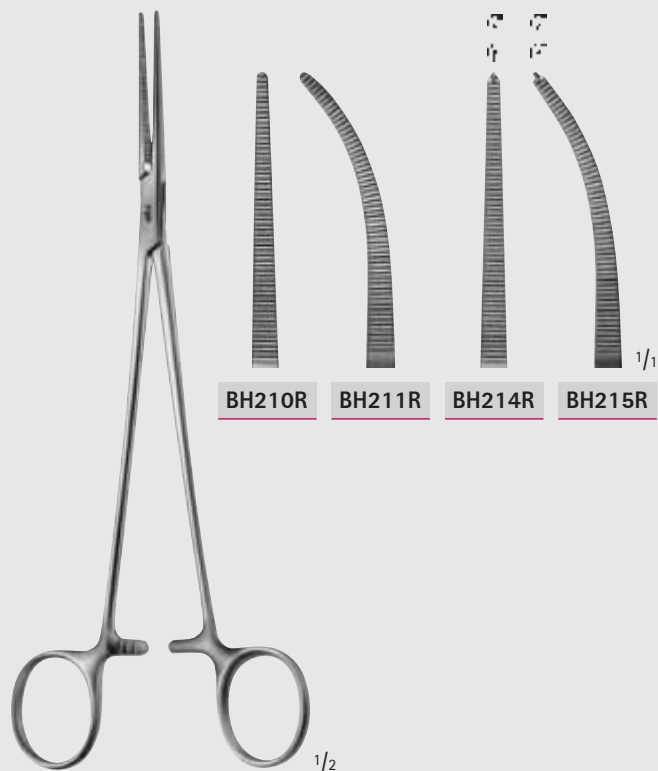

HALSTED-MOSQUITO

BH210R-BH215R

200 mm, 8"



JACOBSON

BH187R

190 mm, 7 1/2"



ADSON

BH205R

215 mm, 8 1/2"



FRASER-KELLY (CRILE)

BH183R

180 mm, 7"



Arterienklemmen – Hemostatic Forceps

Feine Arterienklemmen
Delicate Hemostatic Forceps

BH



DUNHILL

BH191R

190 mm, 7 1/2"

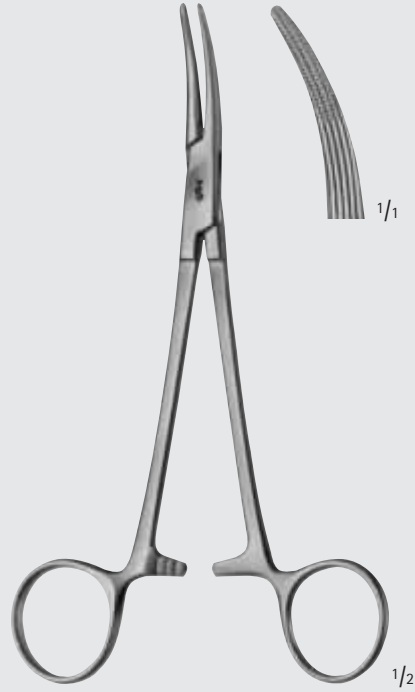

GREY-TURNER

BH193R

180 mm, 7"

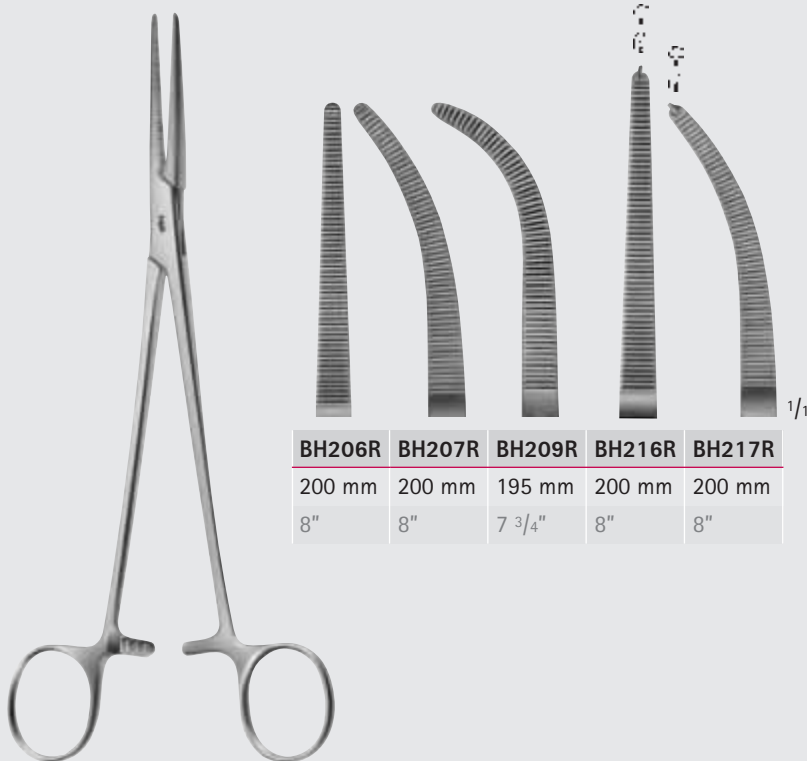

BH206R	BH207R	BH209R	BH216R	BH217R
200 mm	200 mm	195 mm	200 mm	200 mm
8"	8"	7 3/4"	8"	8"

HEISS

BH206R-BH217R

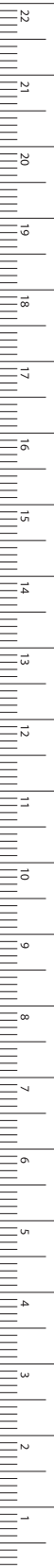

MILLIMETERS

Arterienklemmen – Hemostatic Forceps

Feine Arterienklemmen

Delicate Hemostatic Forceps

BH

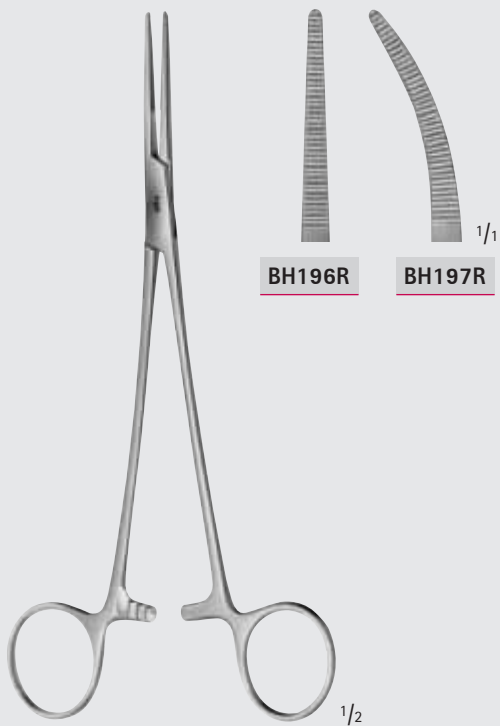
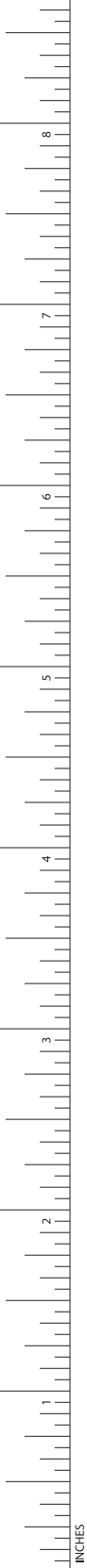

BH196R

BH197R

BIRKETT

BH196R-BH197R

185 mm, 7 1/4"

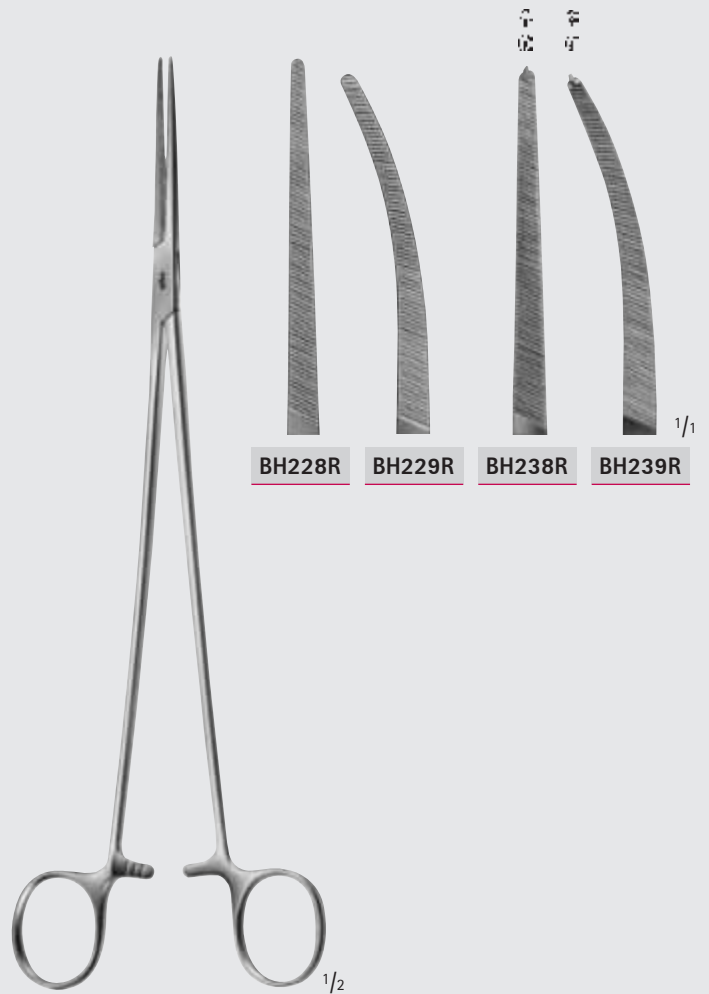

BH228R

BH229R

BH238R

BH239R

BENGOLEA

BH228R-BH239R

245 mm, 9 3/4"



Arterienklemmen – Hemostatic Forceps

Feine Arterienklemmen
Delicate Hemostatic Forceps

BH



SAROT

BH224R-BH234R

240 mm, 9 1/2"

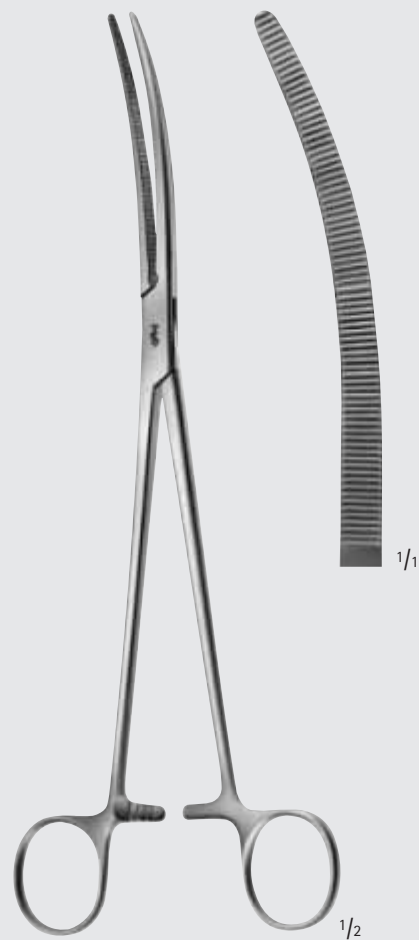

CRAFOORD

BH225R

245 mm, 9 3/4"

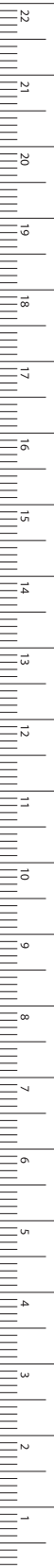

Arterienklemmen – Hemostatic Forceps

Feine Arterienklemmen

Delicate Hemostatic Forceps

BH

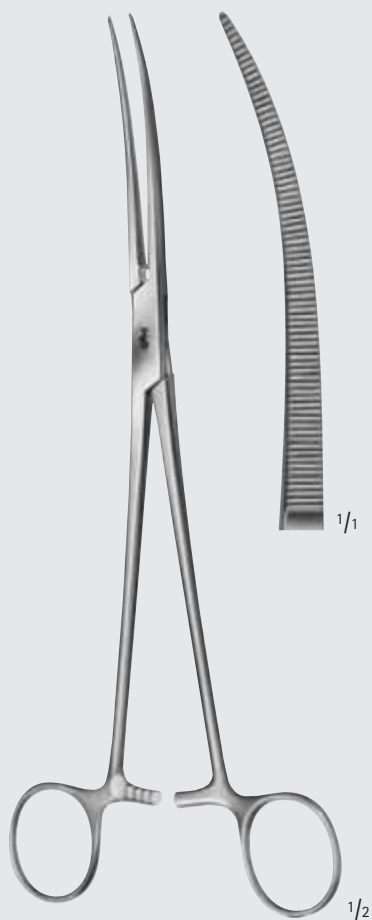

CRAFOORD, MOD.

BH227R

240 mm, 9 1/2"

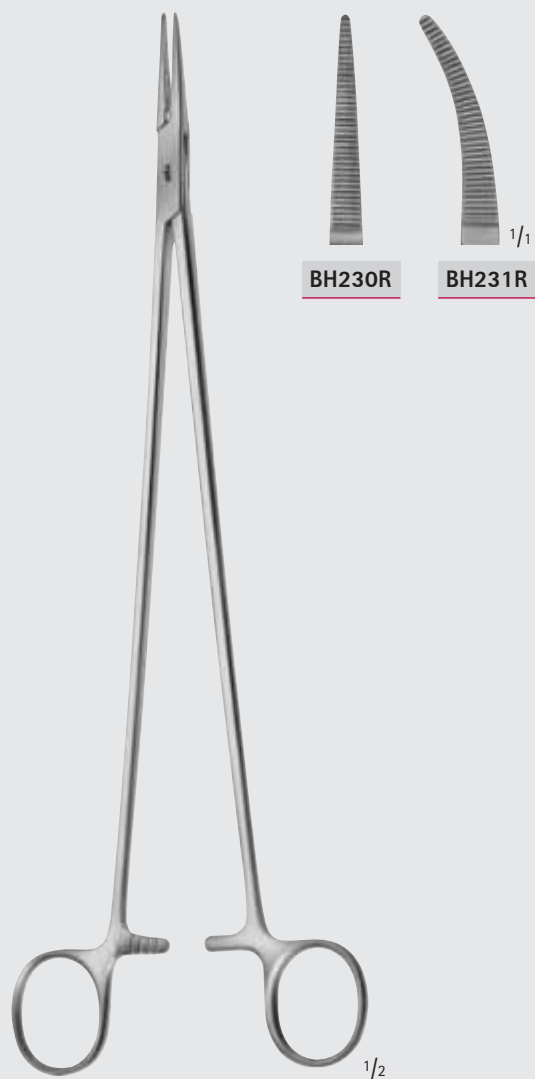

BRIDGE

BH230R-BH231R

275 mm, 10 3/4"



Arterienklemmen – Hemostatic Forceps

Arterienklemmen
Hemostatic Forceps

BH

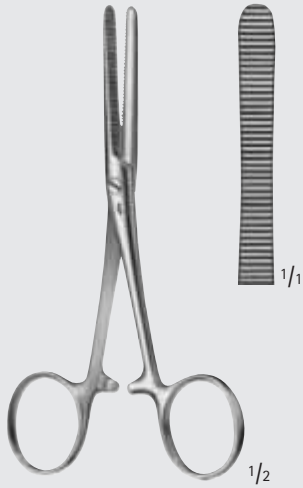
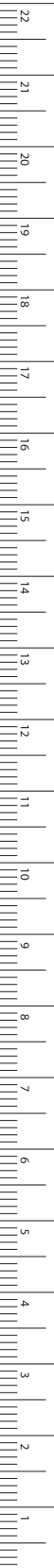

PEAN

BH410R

125 mm, 5"



KRÖNLEIN

BH300R

130 mm, 5 1/8"



BH302R	BH304R
125 mm	140 mm
5"	5 1/2"

PEAN

BH302R-BH304R

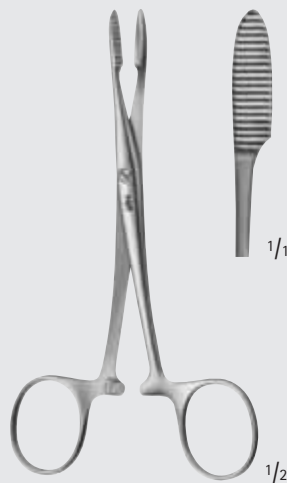

PEAN

BH312R

125 mm, 5"



BH316R	BH318R
165 mm	185 mm
6 1/2"	7 1/4"

PEAN

BH316R-BH318R

Arterienklemmen – Hemostatic Forceps

Arterienklemmen

Hemostatic Forceps

BH

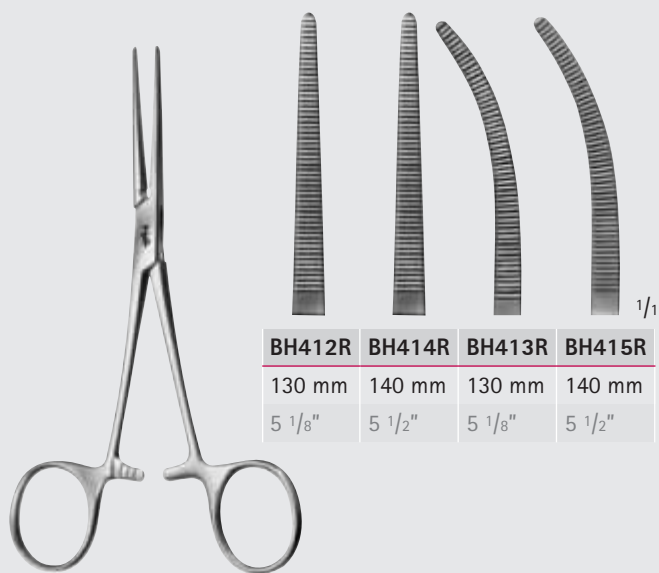

BH412R	BH414R	BH413R	BH415R
130 mm	140 mm	130 mm	140 mm
5 1/8"	5 1/2"	5 1/8"	5 1/2"

PEAN

BH412R-BH415R

grazile Form
slender type



BH422R	BH424R	BH425R
130 mm	140 mm	140 mm
5 1/8"	5 1/2"	5 1/2"

PEAN

BH422R-BH425R

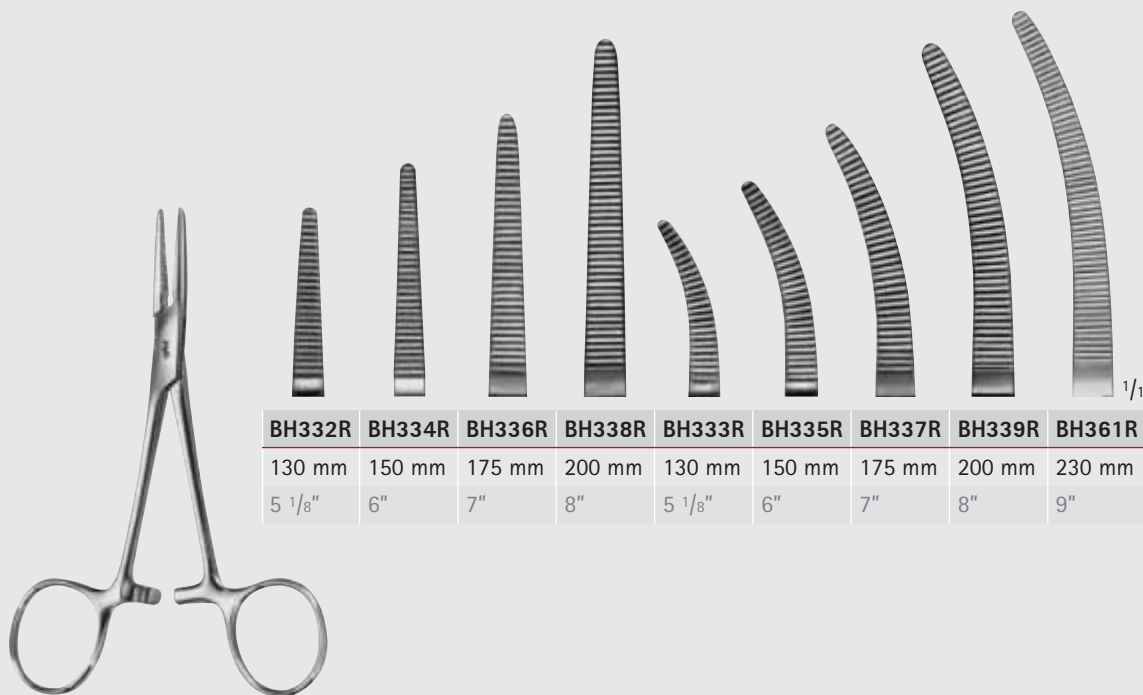

BH332R	BH334R	BH336R	BH338R	BH333R	BH335R	BH337R	BH339R	BH361R
130 mm	150 mm	175 mm	200 mm	130 mm	150 mm	175 mm	200 mm	230 mm
5 1/8"	6"	7"	8"	5 1/8"	6"	7"	8"	9"

SPENCER-WELLS

BH332R-BH361R



Arterienklemmen – Hemostatic Forceps

Arterienklemmen
Hemostatic Forceps

BH

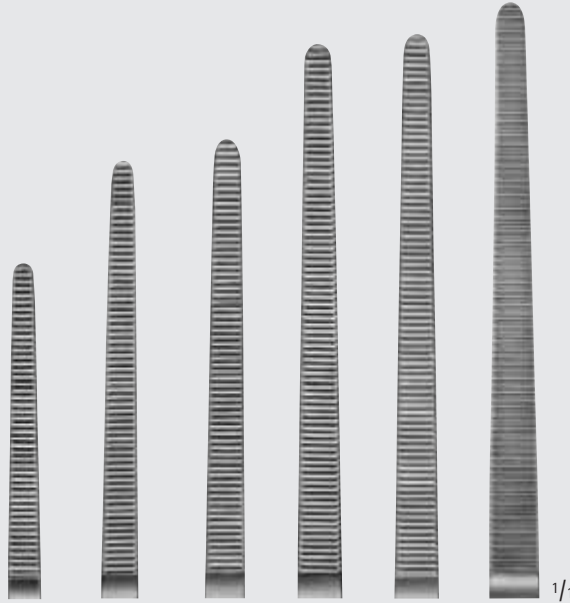

BH442R	BH444R	BH446R	BH448R	BH450R	BH456R
160 mm	185 mm	200 mm	225 mm	240 mm	350 mm
6 1/4"	7 1/4"	8"	9"	9 1/2"	14"

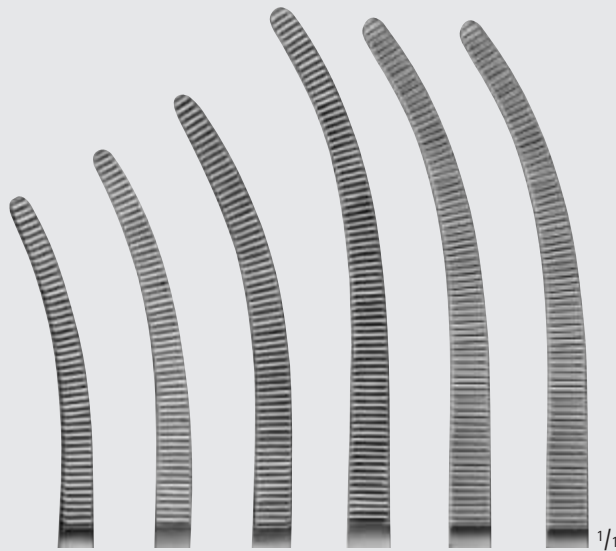

BH443R	BH445R	BH447R	BH449R	BH451R	BH457R
160 mm	185 mm	200 mm	225 mm	240 mm	350 mm
6 1/4"	7 1/4"	8"	9"	9 1/2"	14"



ROCHESTER-PEAN

BH442R-BH457R

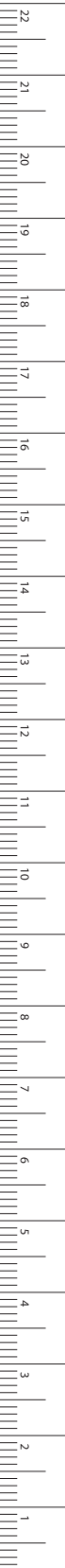

MILLIMETERS

Arterienklemmen – Hemostatic Forceps

Arterienklemmen

Hemostatic Forceps

BH

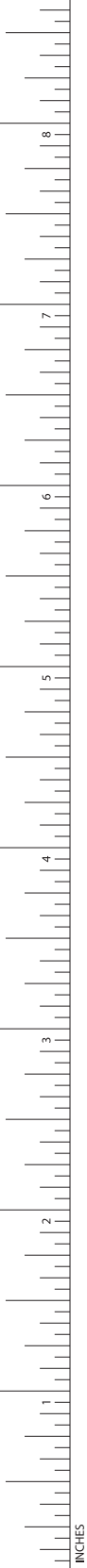

PEAN

BH470R-BH475R

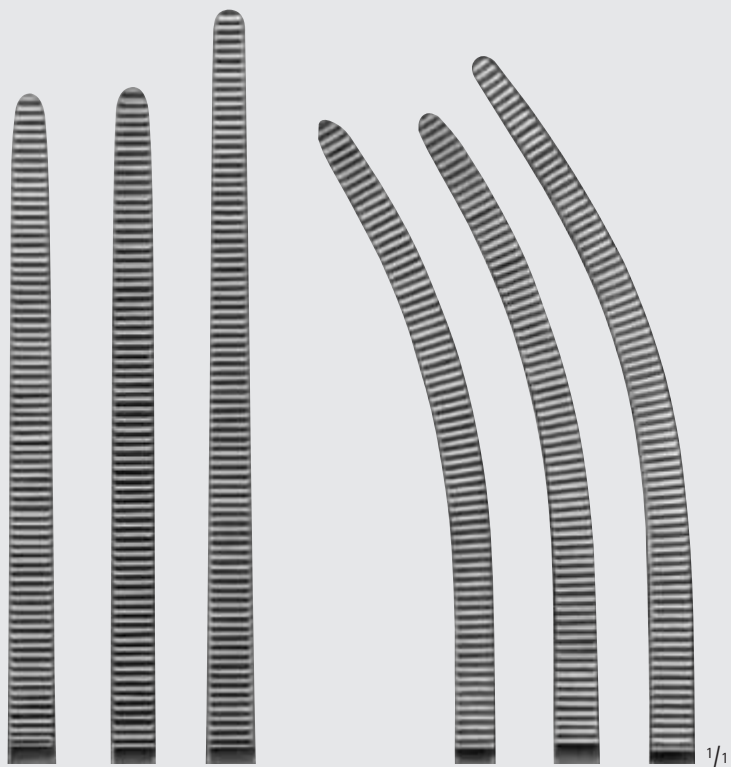

BH470R	BH472R	BH474R
240 mm	260 mm	280 mm
9 1/2"	10 1/4"	11"

BH471R	BH473R	BH475R
240 mm	260 mm	280 mm
9 1/2"	10 1/4"	11"



Arterienklemmen – Hemostatic Forceps

Arterienklemmen
Hemostatic Forceps

BH

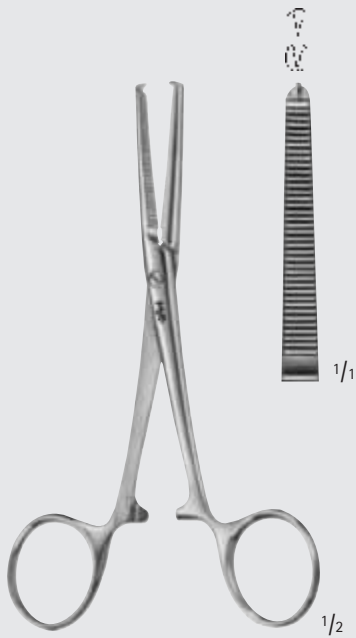

KOCHER

BH610R

kräftiges Modell
strong pattern
145 mm, 5 3/4"

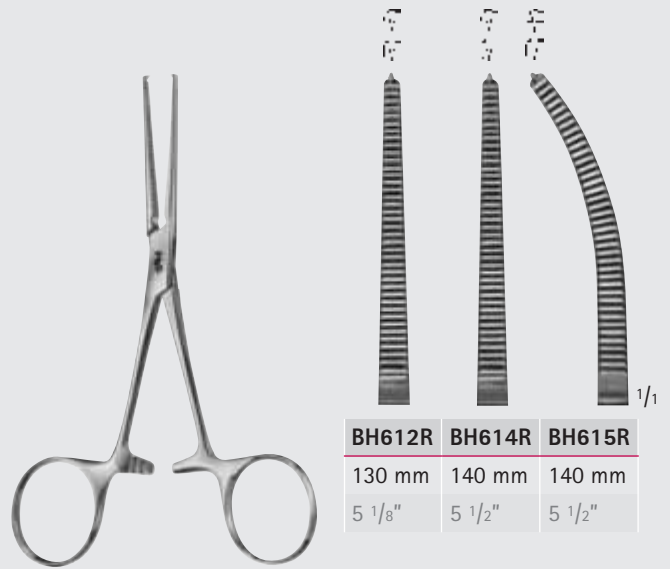

KOCHER

BH612R-BH615R

BH612R	BH614R	BH615R
130 mm	140 mm	140 mm
5 1/8"	5 1/2"	5 1/2"

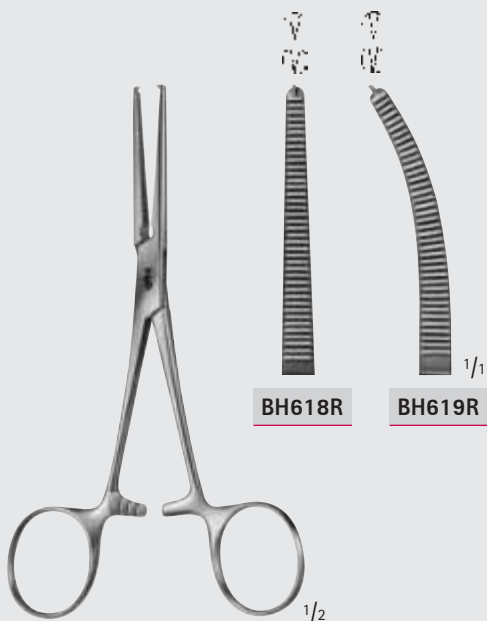

ROCHESTER-OCHSNER

BH618R-BH619R

140 mm, 5 1/2"



KOCHER

BH630R-BH631R

150 mm, 6"

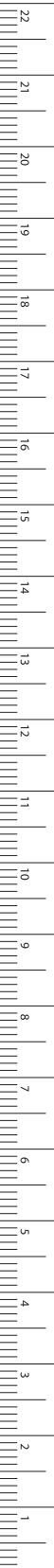

MILLIMETERS

Arterienklemmen – Hemostatic Forceps

Arterienklemmen

Hemostatic Forceps

BH

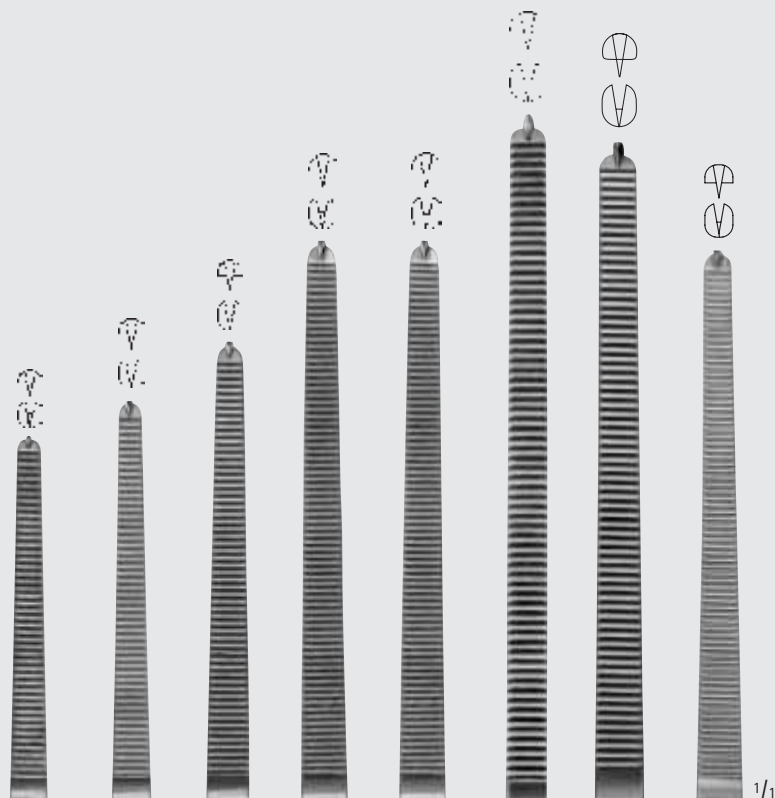

BH642R	BH644R	BH646R	BH648R	BH650R	BH652R	BH654R	BH658R
160 mm	185 mm	200 mm	225 mm	240 mm	260 mm	280 mm	350 mm
6 1/4"	7 1/4"	8"	9"	9 1/2"	10 1/4"	11"	14"



KOCHER-OCHSNER

BH642R-BH659R

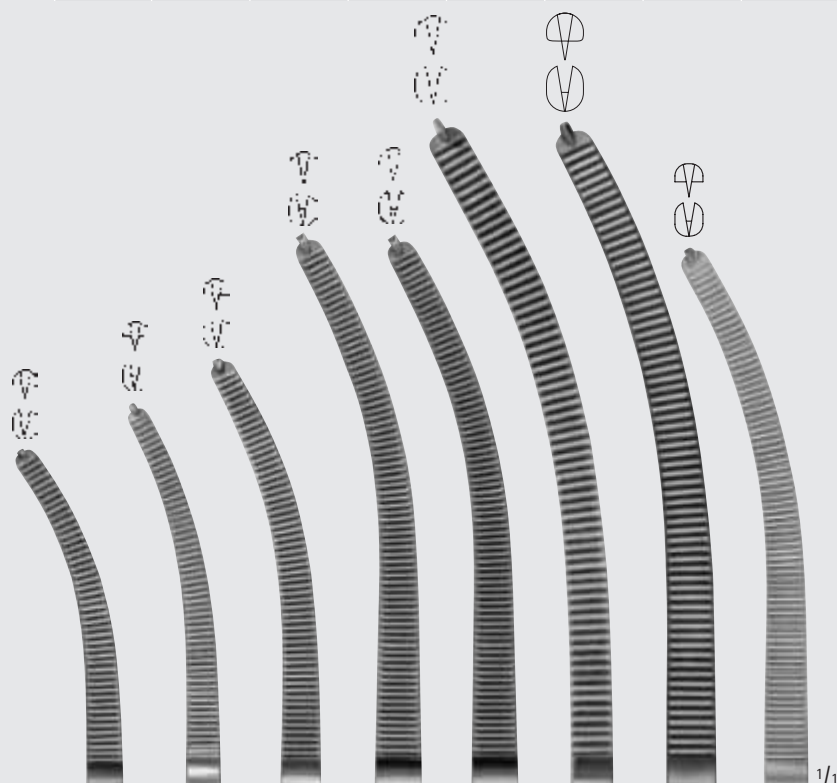

BH643R	BH645R	BH647R	BH649R	BH651R	BH653R	BH655R	BH659R
160 mm	185 mm	200 mm	225 mm	240 mm	260 mm	280 mm	350 mm
6 1/4"	7 1/4"	8"	9"	9 1/2"	10 1/4"	11"	14"



Arterienklemmen – Hemostatic Forceps

Arterienklemmen, Spezial-Modelle
Hemostatic Forceps, Special Patterns

BH

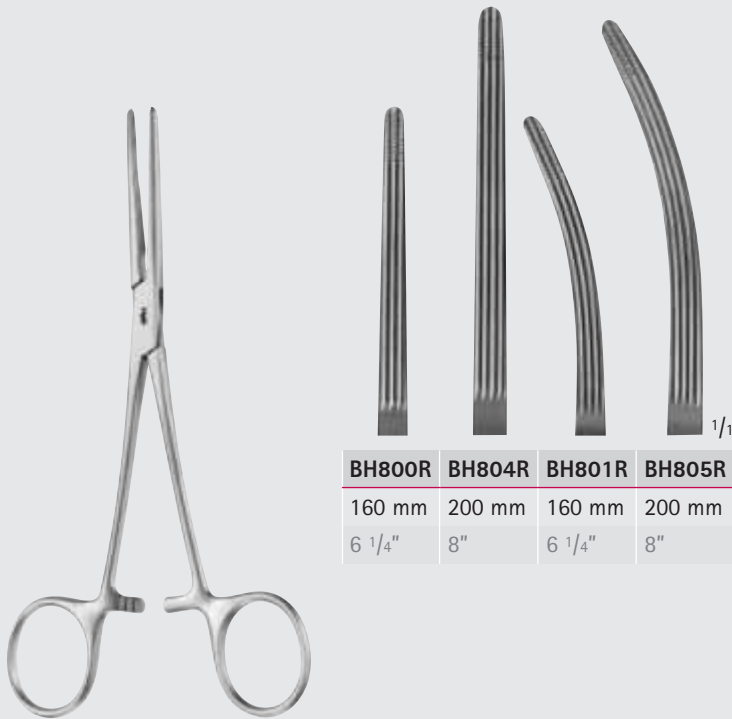
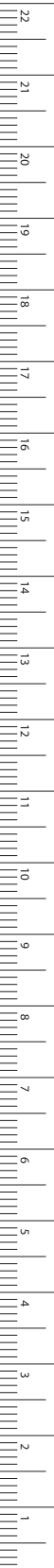

BH800R	BH804R	BH801R	BH805R
160 mm	200 mm	160 mm	200 mm
6 1/4"	8"	6 1/4"	8"

ROCHESTER-CARMALT

BH800R-BH805R

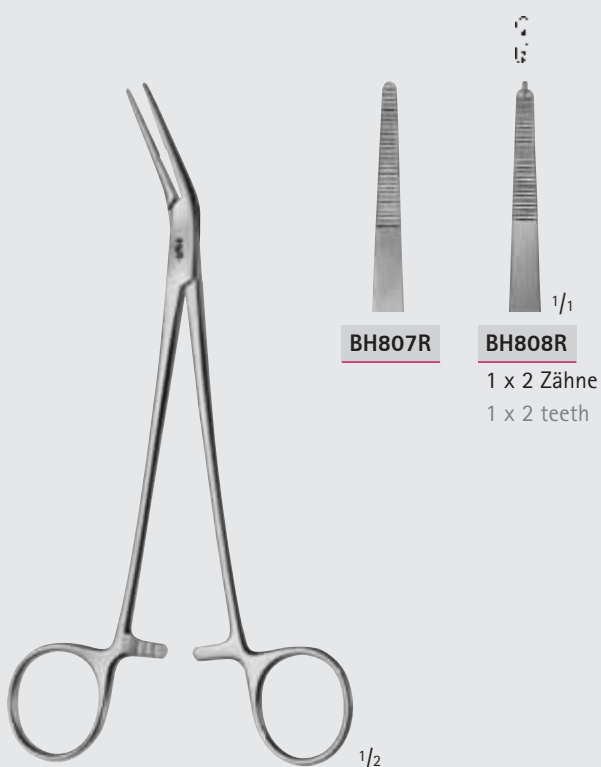

BH807R

BH808R

1 x 2 Zähne
1 x 2 teeth

FICKLING

BH807R-BH808R

180 mm, 7"

MILLIMETERS

Arterienklemmen – Hemostatic Forceps

Arterienklemmen, Spezial-Modelle

Hemostatic Forceps, Special Patterns

BH

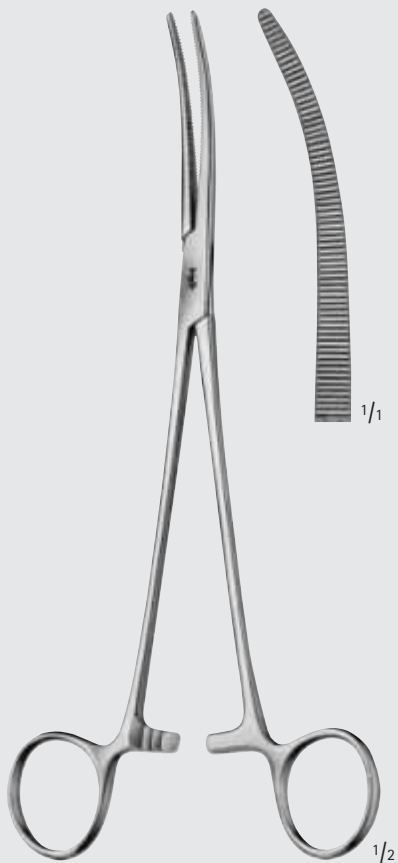

ROBERTS

BH814R

225 mm, 9"



ROBERTS

BH812R-BH813R

250 mm, 10"



SAROT

BH226R

250 mm, 9 3/4"



Arterienklemmen – Hemostatic Forceps

Arterienklemmen, Spezial-Modelle
Hemostatic Forceps, Special Patterns

BH

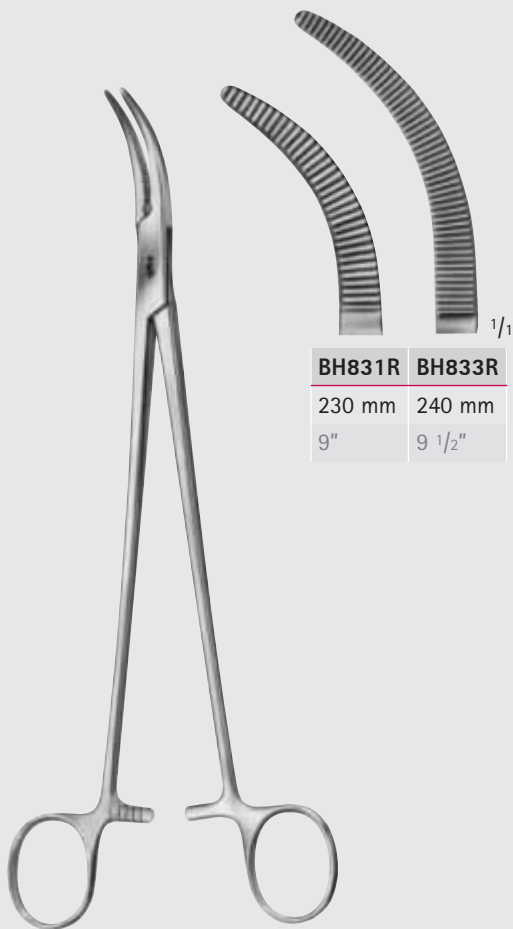

BH831R	BH833R
230 mm	240 mm
9"	9 1/2"

MOYNIHAN

BH831R-BH833R

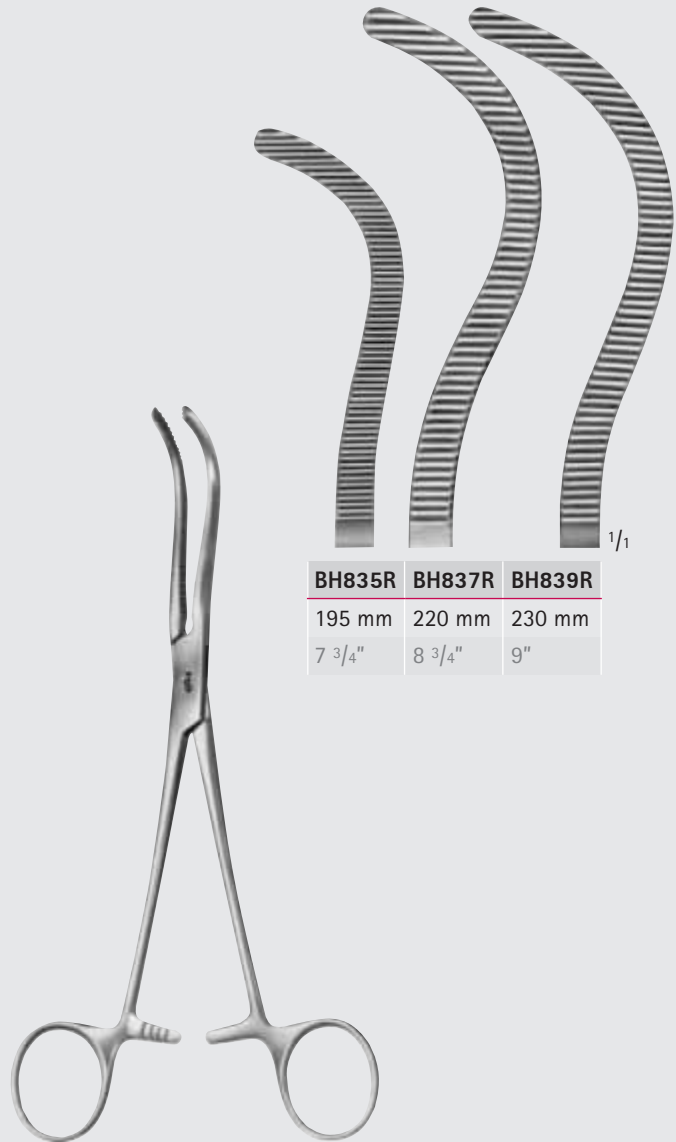

BH835R	BH837R	BH839R
195 mm	220 mm	230 mm
7 3/4"	8 3/4"	9"

PEAN

BH835R-BH839R

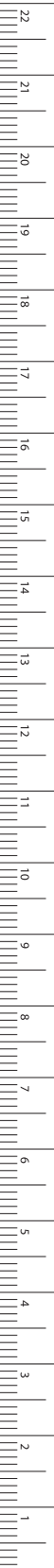

MILLIMETERS

Arterienklemmen – Hemostatic Forceps

Arterienklemmen, Tonsillenklemmen

Hemostatic Forceps, Tonsil Forceps

BH



BH957R **BH959R**

SCHNIDT

BH957R-BH959R

185 mm, 7 1/4"



BH961R **BH963R**

SCHNIDT

BH961R-BH963R

185 mm, 7 1/4"



BH951R **BH952R**

NEGUS

BH951R-BH952R

190 mm, 7 1/2"

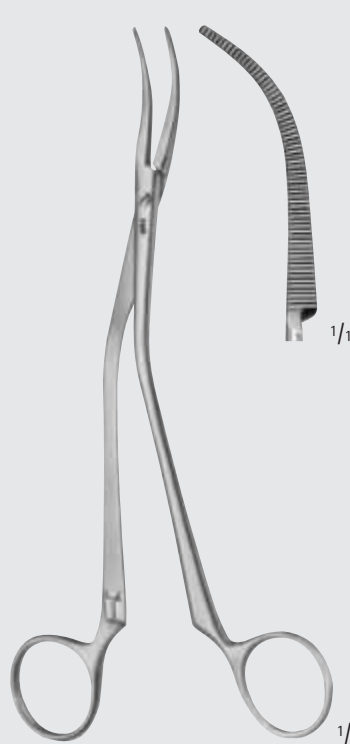

WILSON

BH965R

190 mm, 7 1/2"

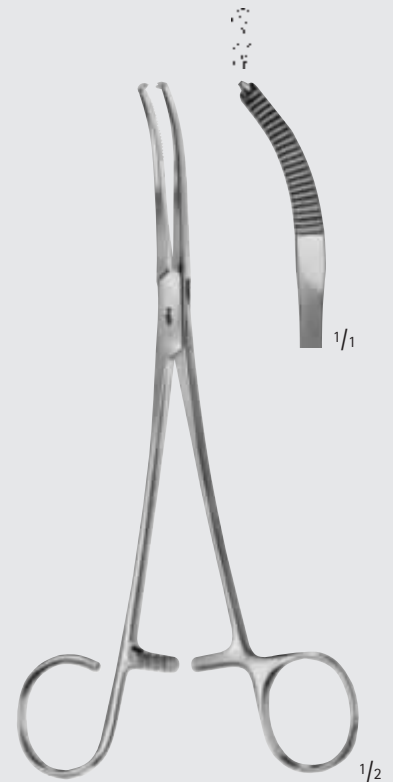

MIKULICZ

BH949R

185 mm, 7 1/4"



Arterienklemmen – Hemostatic Forceps

Arterienklemmen, Spezial-Modelle
Hemostatic Forceps, Special Patterns

BH

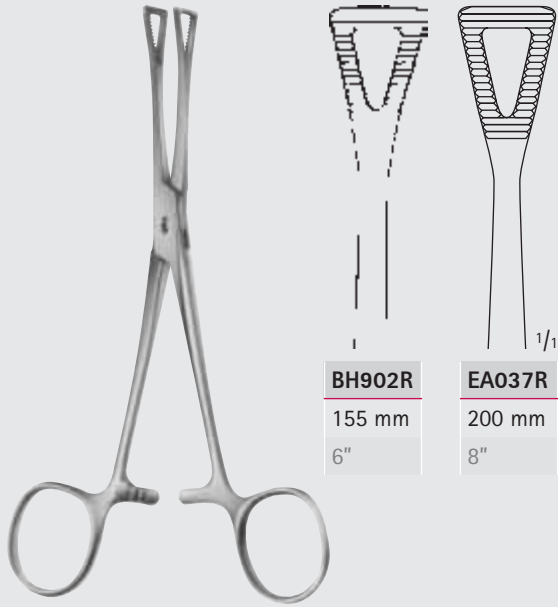
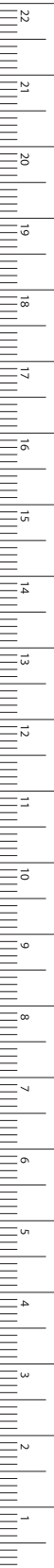

BH902R
155 mm
6"

EA037R
200 mm
8"

PENNINGTON

BH902R-EA037R

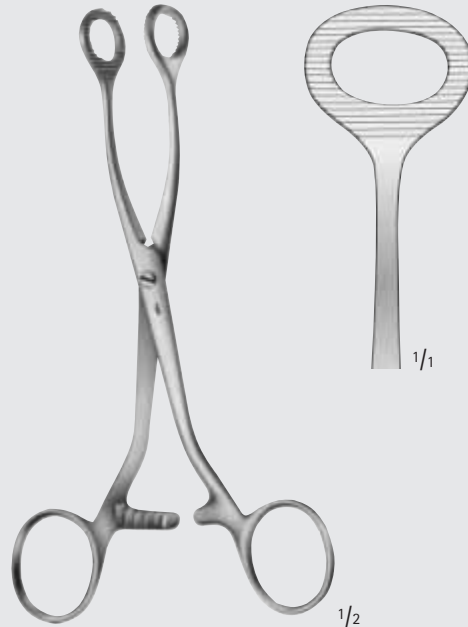

1/1

1/2

COLLIN

BH906R

160 mm, 6 1/4"

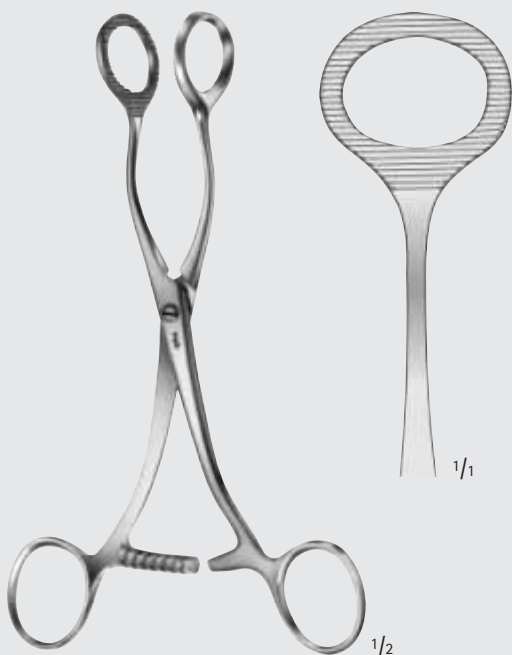

1/1

1/2

COLLIN

AN709R

170 mm, 6 3/4"

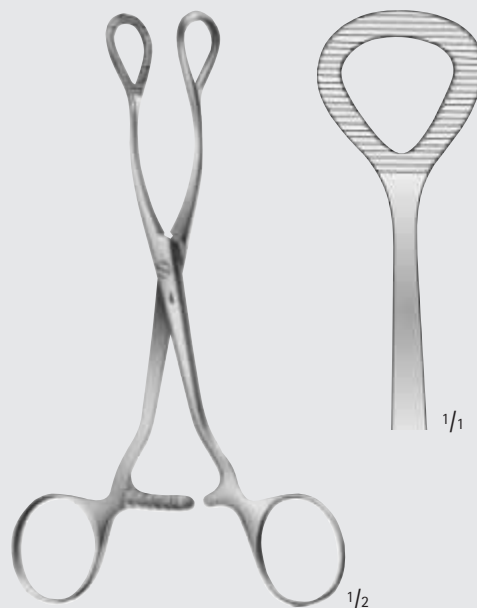

1/1

1/2

COLLIN

BH908R

160 mm, 6 1/4"



INCHES

BJ



Präparier- und Ligaturklemmen,
Hysterektomieklemmen

Dissecting- and Ligature Forceps,
Hysterectomy Clamps

Klemmen – Forceps
 Präparier- und Ligaturklemmen
 Dissecting- and Ligature Forceps

BJ



BJ002R

Ligaturklemme gerade
 Ligature forceps straight
 95 mm, 3 3/4"



MICRO-ADSON

BJ008R

140 mm, 5 1/2"



BABY-OVERHOLT

BJ009R

135 mm, 5 1/4"



BJ011R	BJ012R
140 mm	180 mm
5 1/2"	7"

BABY-MIXTER

BJ011R-BJ012R



Klemmen – Forceps

Präparier- und Ligaturklemmen
Dissecting- and Ligature Forceps

BJ

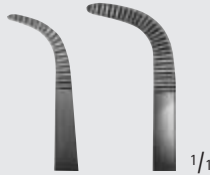
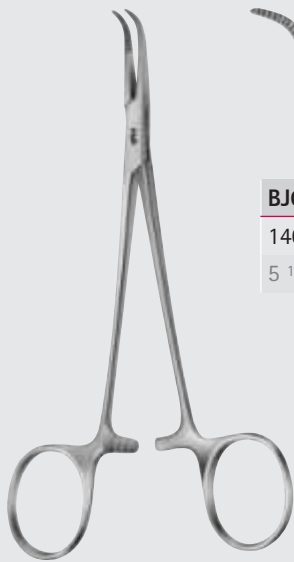

BJ013R	BJ014R
140 mm	180 mm
5 1/2"	7"

BABY-ADSON

BJ013R-BJ014R



MD569	MD570R
140 mm	180 mm
5 1/2"	7"

MD569-MD570R

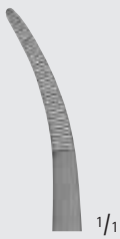
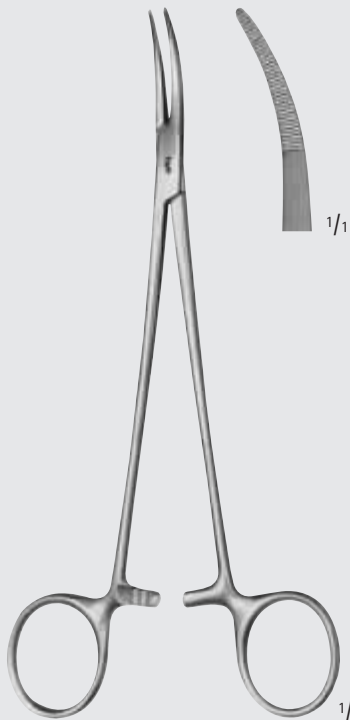

NISSEN

BH199R

185 mm, 7 1/4"

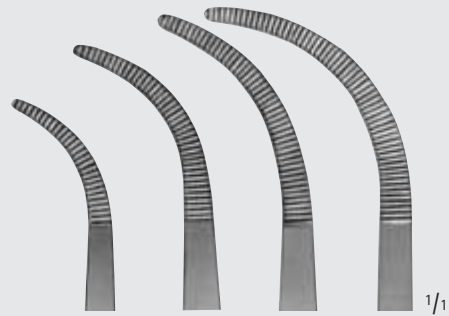
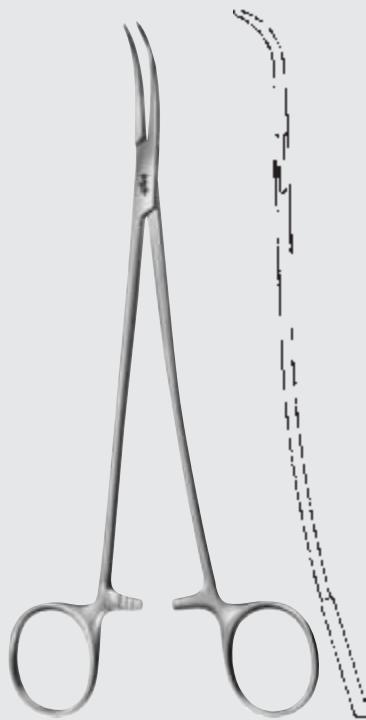

BJ015R	BJ016R	BJ017R	BJ018R
185 mm	210 mm	215 mm	220 mm
7 1/4"	8 1/4"	8 1/2"	8 3/4"

BJ015R-BJ018R

S-förmig gebogen, grazil
S-shaped, delicate

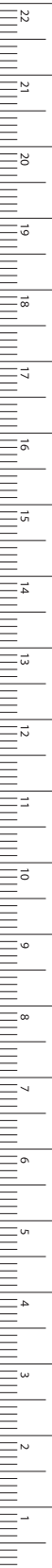

MILLIMETERS

Klemmen – Forceps

Präparier- und Ligaturklemmen

Dissecting- and Ligature Forceps

BJ

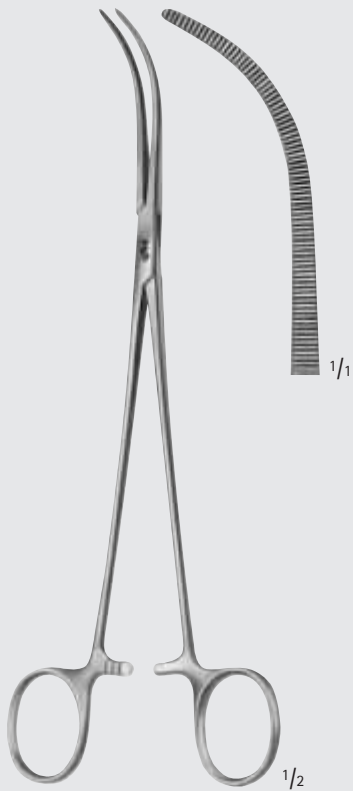

OVERHOLT-MIXTER

BJ019R

205 mm, 8"

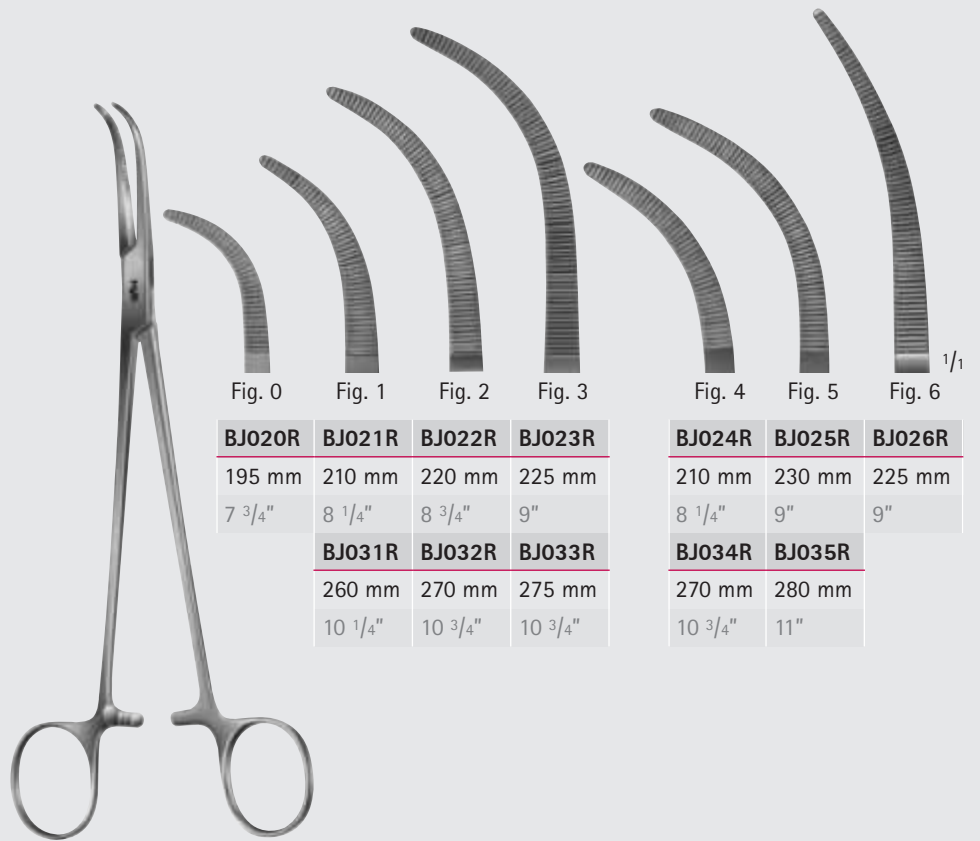

Fig. 0

Fig. 1

Fig. 2

Fig. 3

Fig. 4

Fig. 5

Fig. 6

BJ020R	BJ021R	BJ022R	BJ023R	BJ024R	BJ025R	BJ026R
195 mm	210 mm	220 mm	225 mm	210 mm	230 mm	225 mm
7 3/4"	8 1/4"	8 3/4"	9"	8 1/4"	9"	9"
BJ031R	BJ032R	BJ033R	BJ034R	BJ035R		
260 mm	270 mm	275 mm	270 mm	280 mm		
10 1/4"	10 3/4"	10 3/4"	10 3/4"	11"		

OVERHOLT-GEISSENDOERFER

BJ020R-BJ035R



Klemmen – Forceps
 Präparier- und Ligaturklemmen
 Dissecting- and Ligature Forceps

BJ

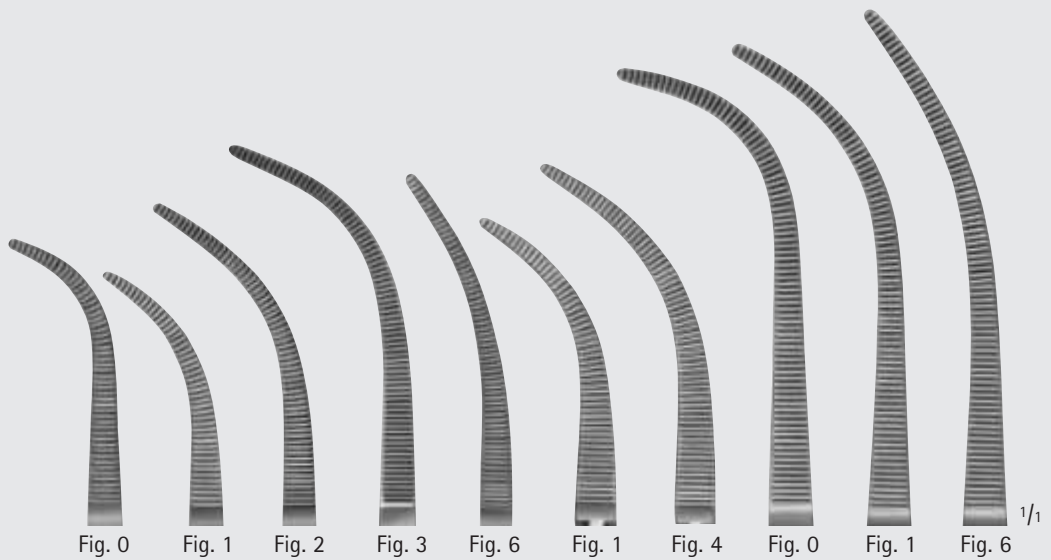
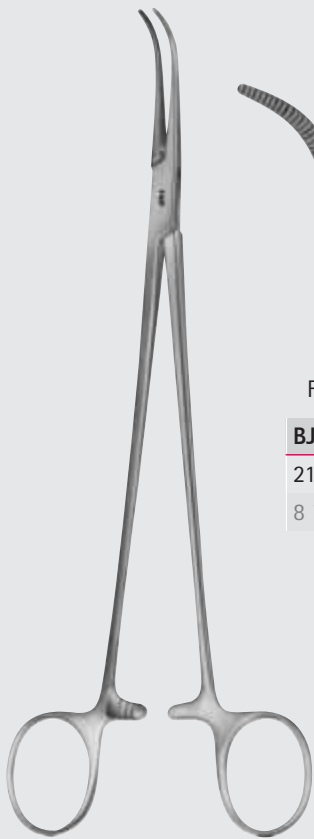
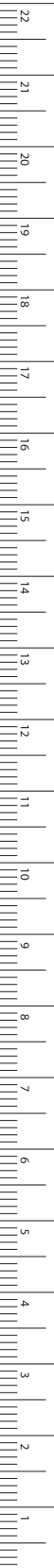

BJ080R	BJ081R	BJ082R	BJ083R	BJ086R	BJ111R	BJ114R	BJ090R	BJ091R	BJ096R
215 mm	210 mm	220 mm	225 mm	225 mm	270 mm	270 mm	295 mm	295 mm	300 mm
8 1/2"	8 1/4"	8 3/4"	9"	9"	10 3/4"	10 3/4"	11 3/4"	11 3/4"	12"

OVERHOLT

BJ080R-BJ114R

feine Ausführung
 delicate pattern

Klemmen – Forceps

Präparier- und Ligaturklemmen

Dissecting- and Ligature Forceps

BJ

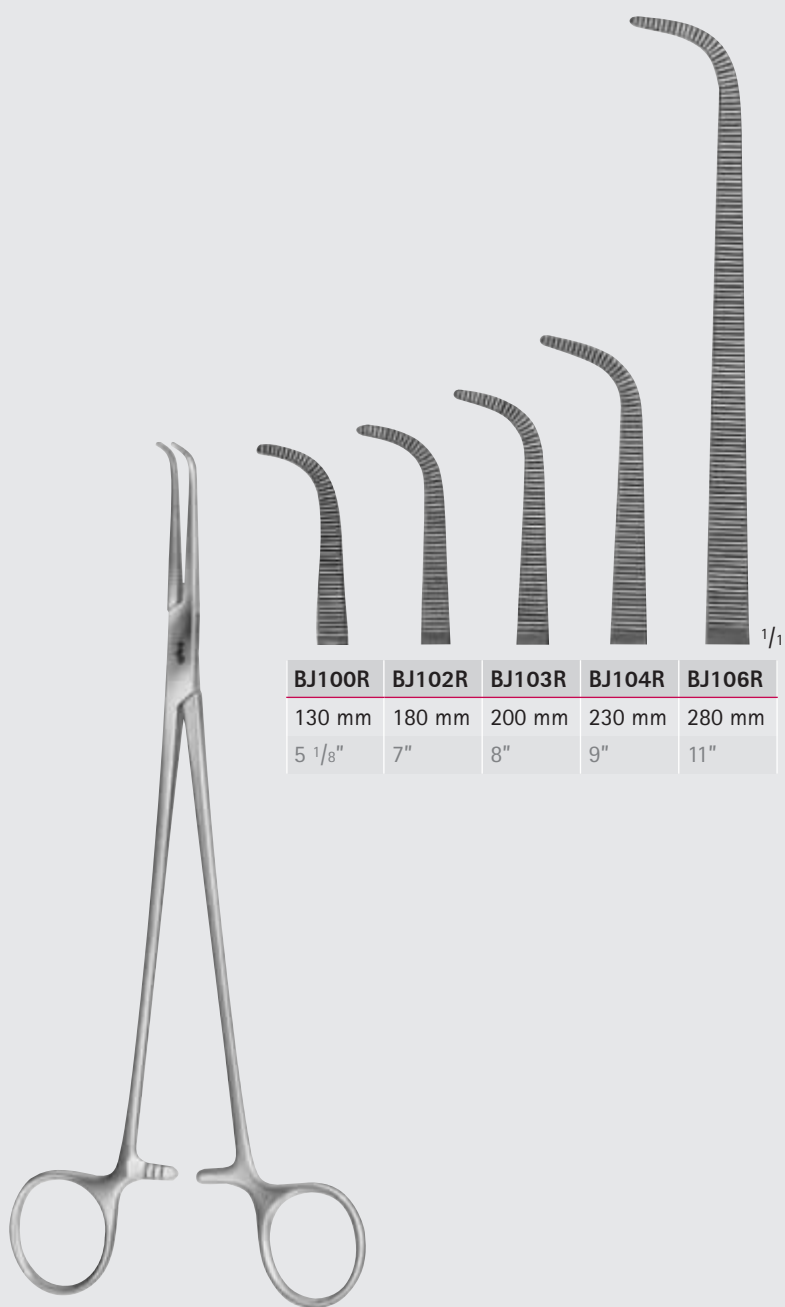

BJ100R	BJ102R	BJ103R	BJ104R	BJ106R
130 mm	180 mm	200 mm	230 mm	280 mm
5 1/8"	7"	8"	9"	11"

GEMINI

BJ100R-BJ106R



Klemmen – Forceps
Präparier- und Ligaturklemmen
Dissecting- and Ligature Forceps

BJ



MIXTER-O'SHAUGNESSY

BJ050R

190 mm, 7 1/2"



O'SHAUGNESSY

BJ067R

220 mm, 8 3/4"

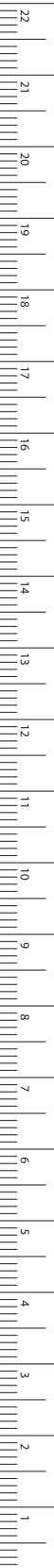

MILLIMETERS

Klemmen – Forceps
Präparier- und Ligaturklemmen
Dissecting- and Ligature Forceps

BJ



HEISS

BH209R

195 mm, 7 3/4"



WIKSTROEM

BJ051R

205 mm, 8"



Klemmen – Forceps
 Präparier- und Ligaturklemmen
 Dissecting- and Ligature Forceps

BJ

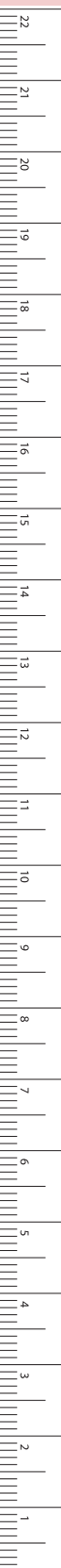

MILLIMETERS



BJ041R **BJ042R** **BJ043R** **BJ044R** **BJ045R**

RUMEL
BJ041R-BJ045R
 240 mm, 9 1/2"

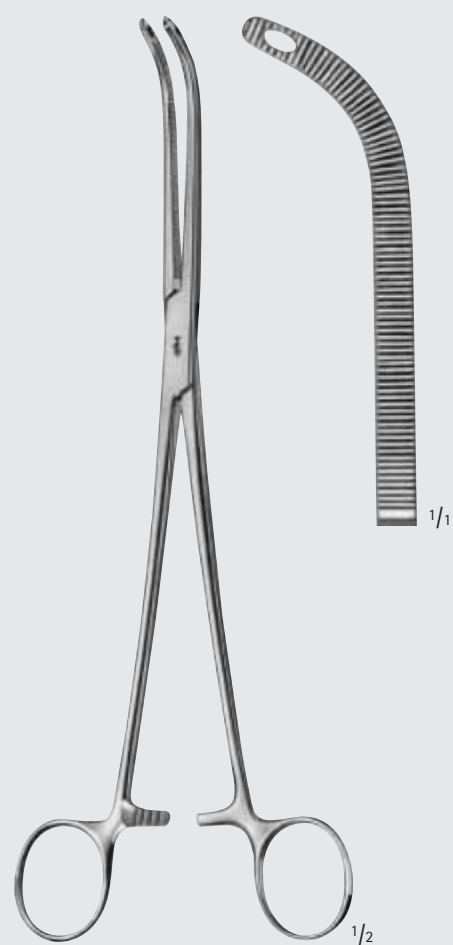

FINOCHIETTO
BJ052R
 245 mm, 9 3/4"

Klemmen – Forceps

Präparier- und Ligaturklemmen

Dissecting- and Ligature Forceps

BJ

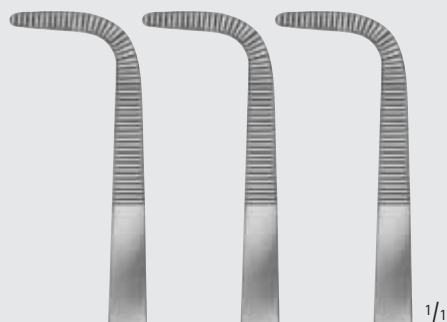

BJ057R

200 mm

8"

BJ058R

240 mm

9 1/2"

BJ059R

275 mm

10 3/4"

KANTROWITZ

BJ057R-BJ059R

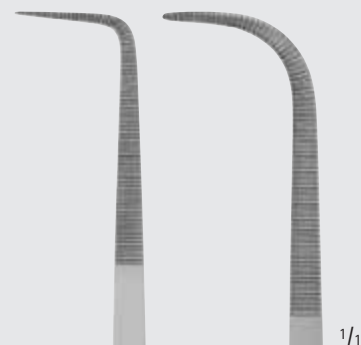

BJ029R

extra fein

extra delicate

BJ110R

fein

delicate

BARRE

BJ029R-BJ110R

280 mm, 11"

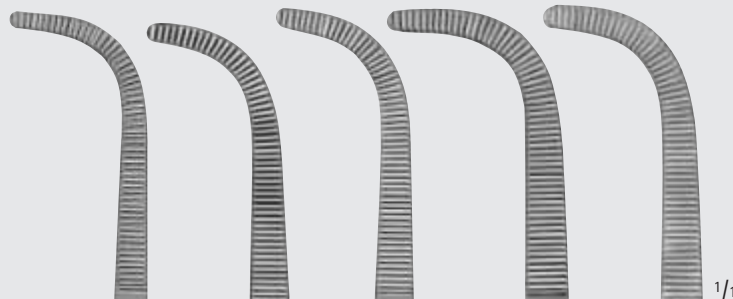

BJ120R

150 mm

6"

BJ121R

180 mm

7"

BJ122R

200 mm

8"

BJ123R

230 mm

9"

BJ124R

255 mm

10"

O'SHAUGHNESSY

BJ120R-BJ124R





Klemmen – Forceps
Präparier- und Ligaturklemmen
Dissecting- and Ligature Forceps

BJ

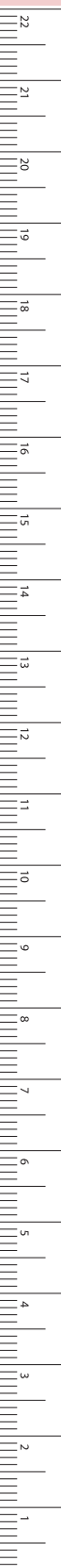

MILLIMETERS



MIXTER

BJ055R

230 mm, 9"



LAWRENCE

BJ070R

270 mm, 10 3/4"

Klemmen – Forceps

Präparier- und Ligaturklemmen

Dissecting- and Ligature Forceps

BJ

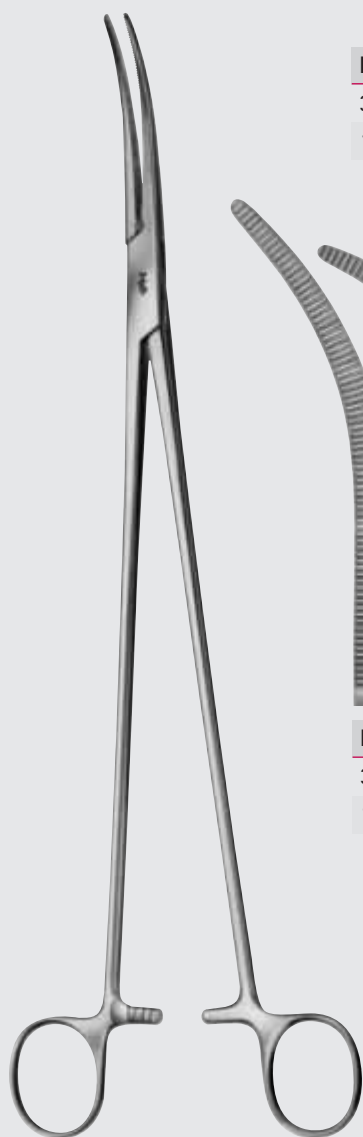

ZENKER

BJ047R-BJ132R



BJ047R

300 mm

12"

BJ048R

290 mm

11 1/2"

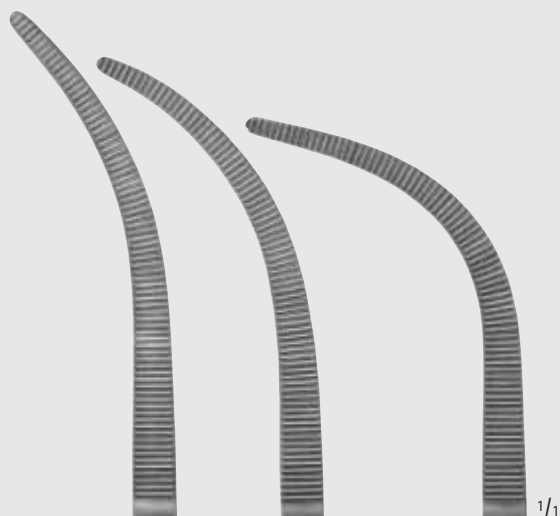

BJ130R

350 mm

14"

BJ131R

350 mm

14"

BJ132R

350 mm

14"

1/1



KIEBACK

BJ075R-BJ076R

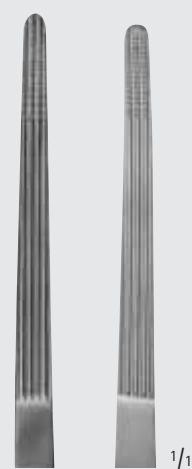

BJ075R

235 mm

9 1/4"

BJ076R

350 mm

14"

1/1

Ureter-Tunnelier-Klemme, aufgebogen
Ureteral tunnel clamp curved on flat



Klemmen – Forceps
 Präparier- und Ligaturklemmen
 Dissecting- and Ligature Forceps

BJ

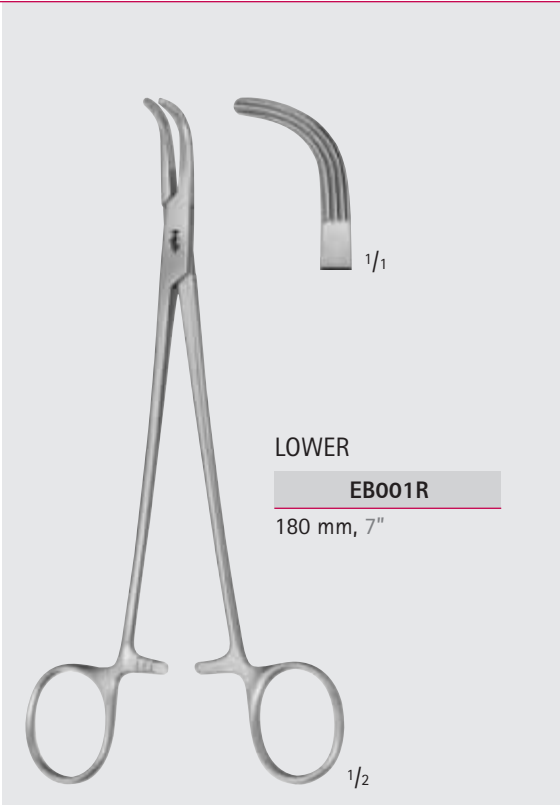

LOWER
EB001R
 180 mm, 7"

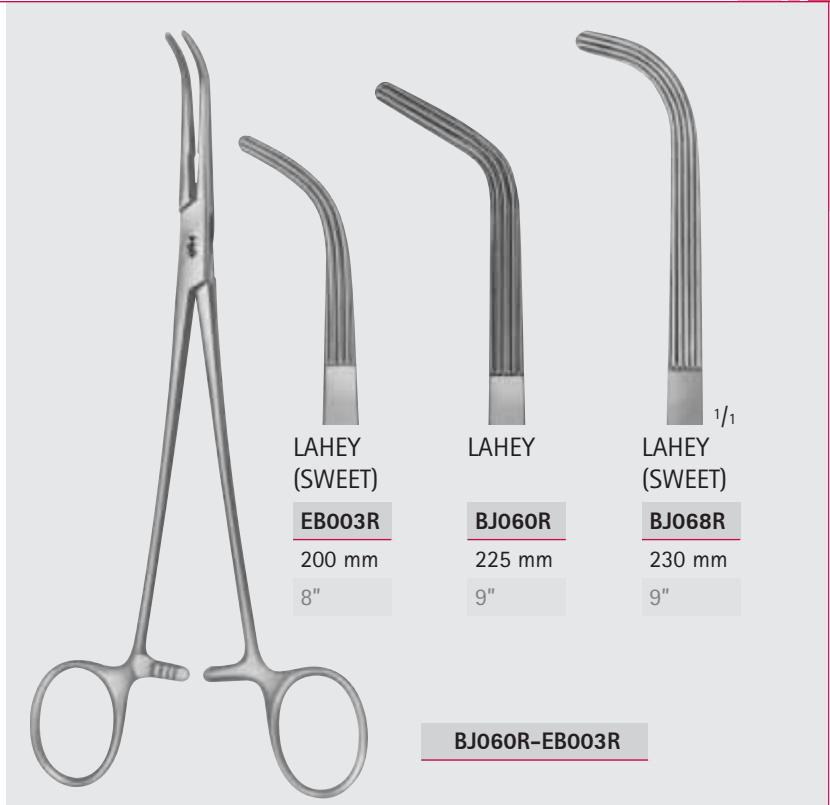

LAHEY (SWEET)
EB003R
 200 mm
 8"

LAHEY
BJ060R
 225 mm
 9"

LAHEY (SWEET)
BJ068R
 230 mm
 9"

BJ060R-EB003R



MIXTER
BJ061R-BJ073R

BJ061R
 220 mm
 8 3/4"

BJ062R
 250 mm
 10"

BJ073R
 290 mm
 11 1/2"



MILLIMETERS

Klemmen – Forceps
 Präparier- und Ligaturklemmen
 Dissecting- and Ligature Forceps

BJ



DESJARDINS
EBO08R
 210 mm, 8 1/4"

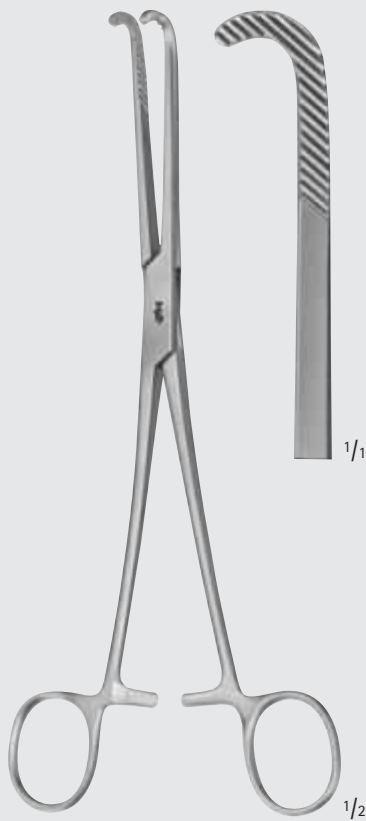

NISSEN
EBO09R
 215 mm, 8 1/2"

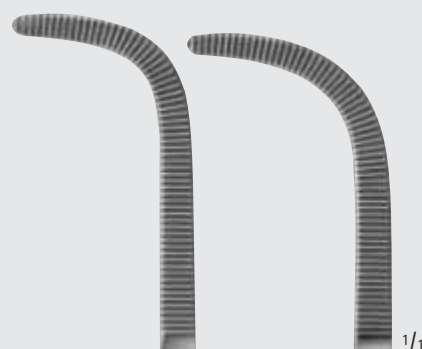

EB011R **EB012R**



GRAY
EB011R-EB012R
 220 mm, 8 3/4"



Klemmen – Forceps
 Peritoneumklemmen
 Peritoneum Forceps

BJ



MILLIMETERS



BABY-MIKULICZ

BJ300R

140 mm, 5 1/2"



MIKULICZ

BJ304R

185 mm, 7 1/4"

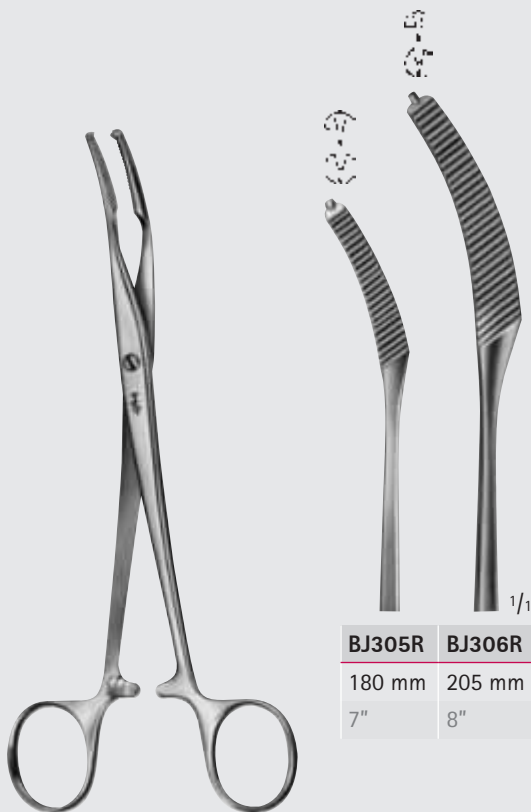

MIKULICZ

BJ305R-BJ306R

BJ305R	BJ306R
180 mm	205 mm
7"	8"



MIKULICZ

BJ308R

205 mm, 8"

Klemmen – Forceps

Peritoneumklemmen

Peritoneum Forceps

BJ

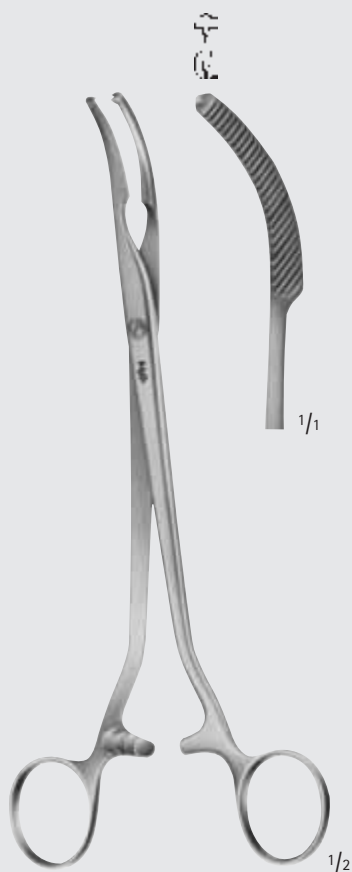

MIKULICZ

BJ309R

205 mm, 8"



MIKULICZ

BJ310R

200 mm, 8"



MIKULICZ

BJ312R

245 mm, 9 3/4"



Klemmen – Forceps
Peritoneumklemmen
Peritoneum Forceps

BJ

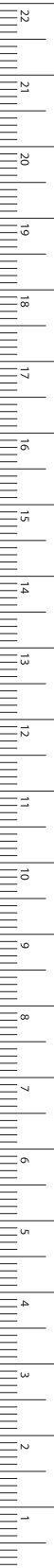

MILLIMETERS

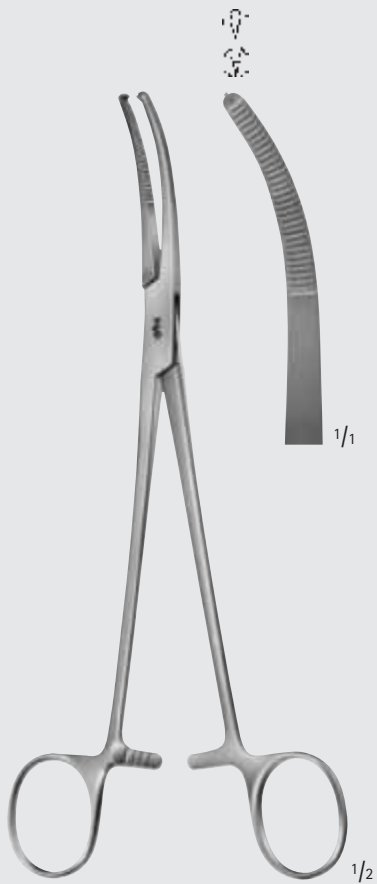

MIKULICZ

BJ313R

205 mm, 8"



MIKULICZ

BJ314R

205 mm, 8"

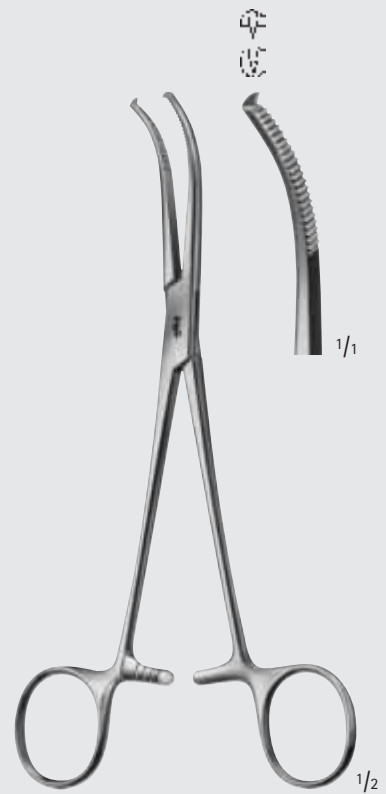

MIKULICZ

BJ315R

185 mm, 7 1/4"

Klemmen – Forceps
 Hysterektomieklemmen
 Hysterectomy Forceps

BJ

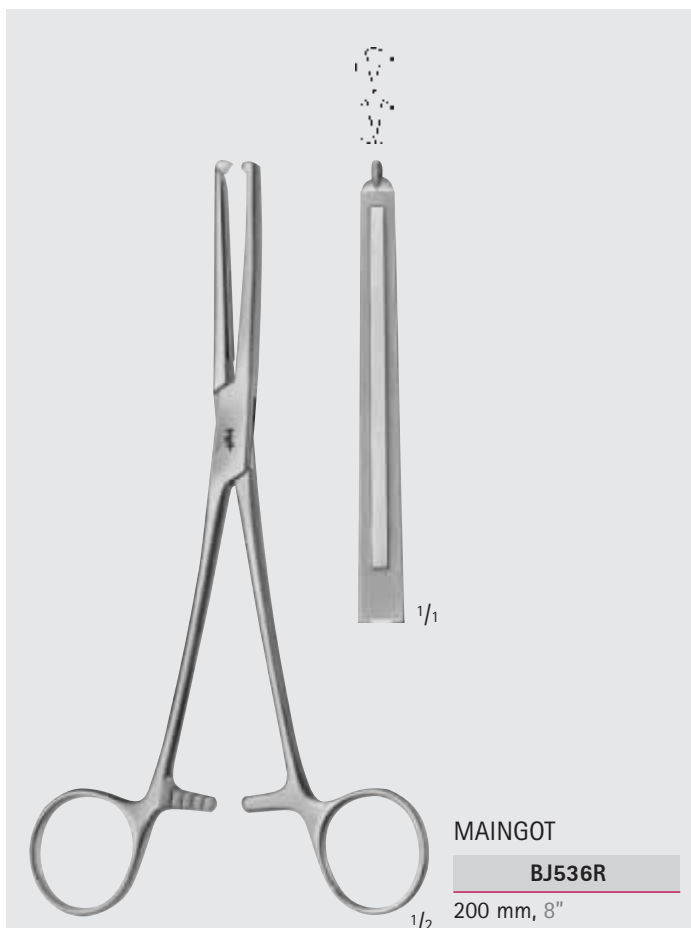
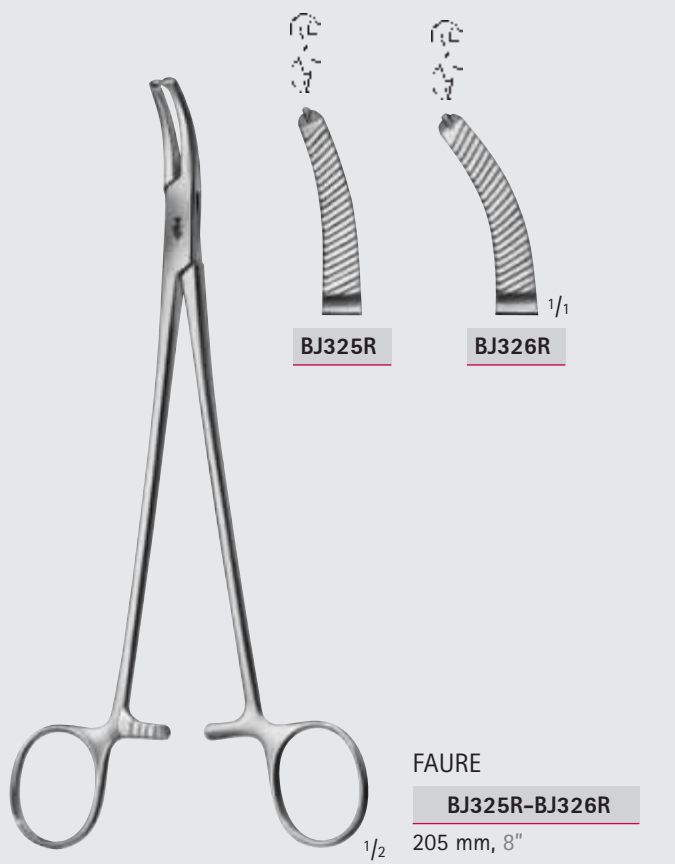



Klemmen – Forceps

Peritoneum- und Hysterektomieklemmen
Peritoneum and Hysterectomy Forceps

BJ



HEANEY MODIF.

BJ520R-BJ529R



HEANEY

BJ522R

195 mm, 7 3/4"



HEANEY-REZEK

BJ524R

210 mm, 8 1/4"

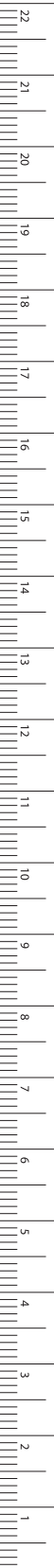

MILLIMETERS

Klemmen – Forceps
 Hysterektomieklemmen
 Hysterectomy Forceps

BJ



HEANEY-BALLENTINE

MD591-MD592

215 mm, 8 1/2"

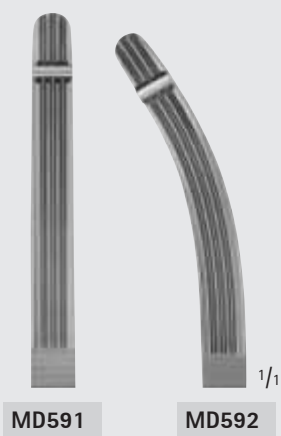

MD591

MD592

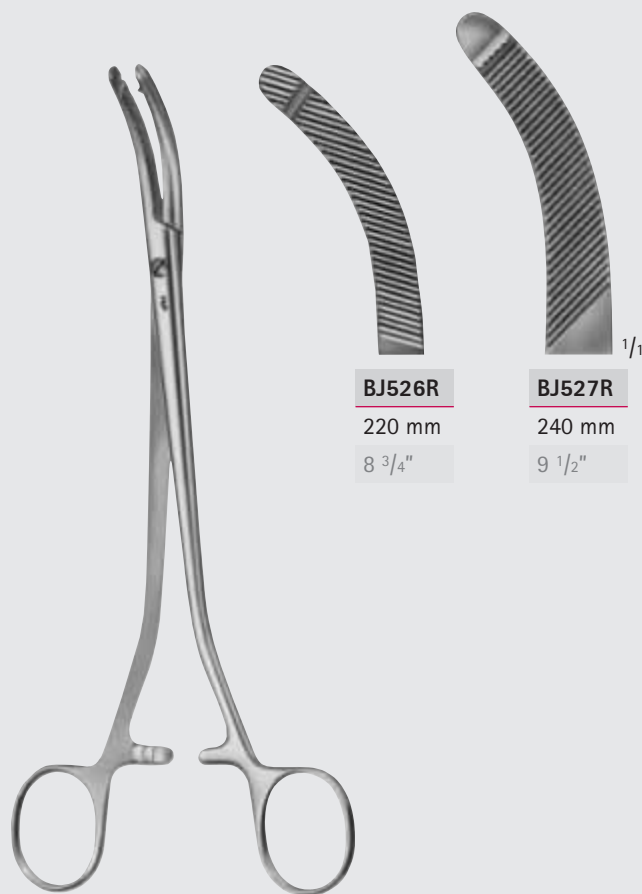

WIENER MODELL

BJ526R-BJ527R

BJ526R

220 mm

8 3/4"

BJ527R

240 mm

9 1/2"



Klemmen – Forceps
Hysterektomie- und Arterienklemmen
Hysterectomy- and Hemostatic Forceps

BJ



WERTHEIM

BJ506R

235 mm, 9 1/4"



WERTHEIM

BJ507R

235 mm, 9 1/4"

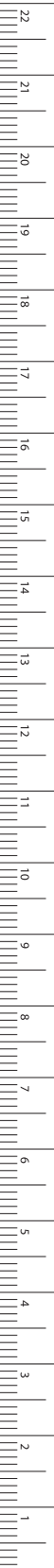

MILLIMETERS

Klemmen – Forceps

Hysterektomie- und Arterienklemmen

Hysterectomy- and Hemostatic Forceps

BJ

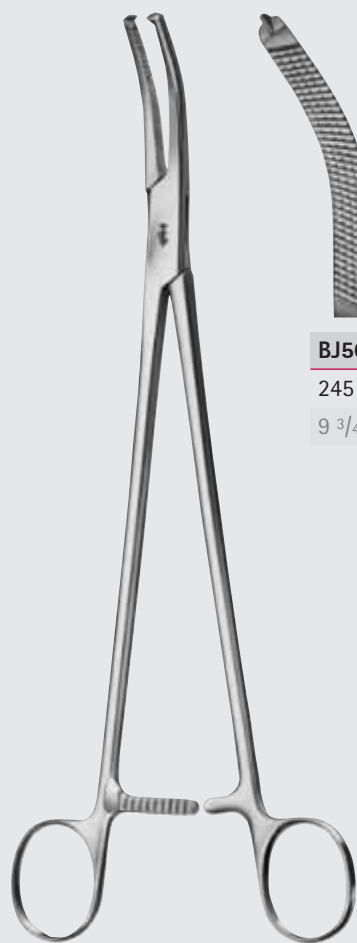

WERTHEIM

BJ509R-BJ515R



BJ509R

245 mm

9 3/4"

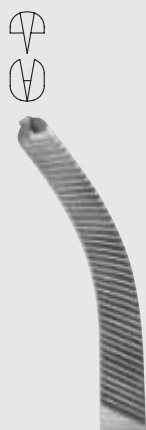

BJ515R

350 mm

14"



SEGOND-LANDAU

BJ540R

240 mm, 9 1/2"



1/1

1/2



Klemmen – Forceps
 Hysterektomie- und Arterienklemmen
 Hysterectomy- and Hemostatic Forceps

BJ

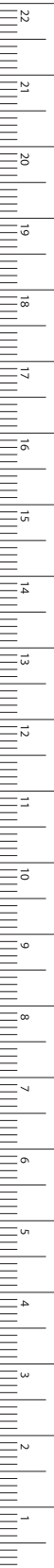

MILLIMETERS



SEGOND

BJ541R

240 mm, 9 1/2"

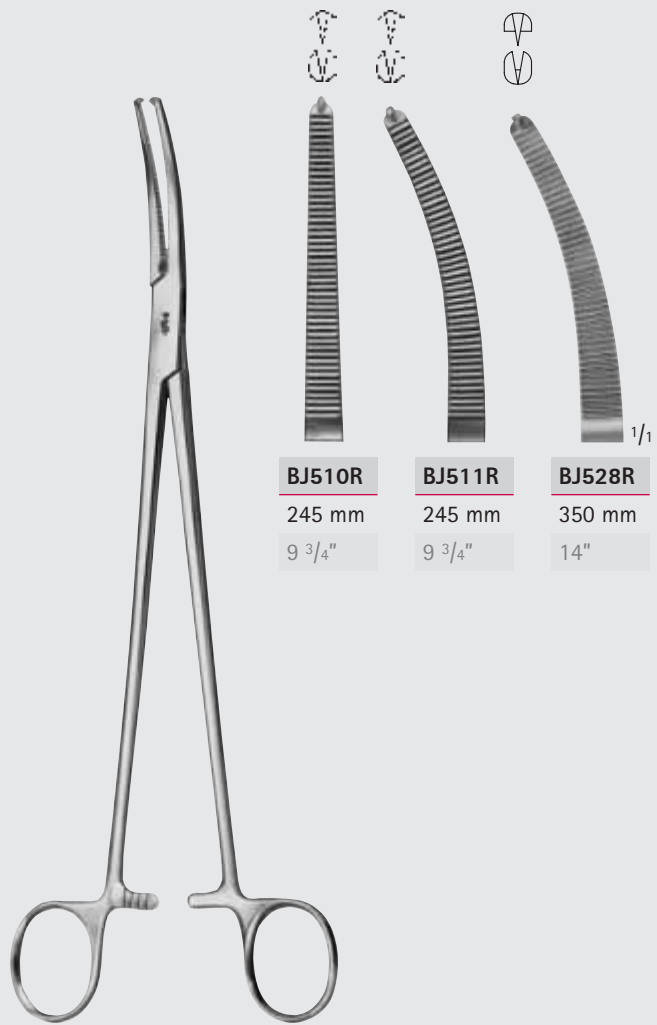

HOLZBACH

BJ510R-BJ528R

BJ510R

245 mm

9 3/4"

BJ511R

245 mm

9 3/4"

BJ528R

350 mm

14"

Klemmen – Forceps

Hysterektomie- und Arterienklemmen

Hysterectomy- and Hemostatic Forceps

BJ

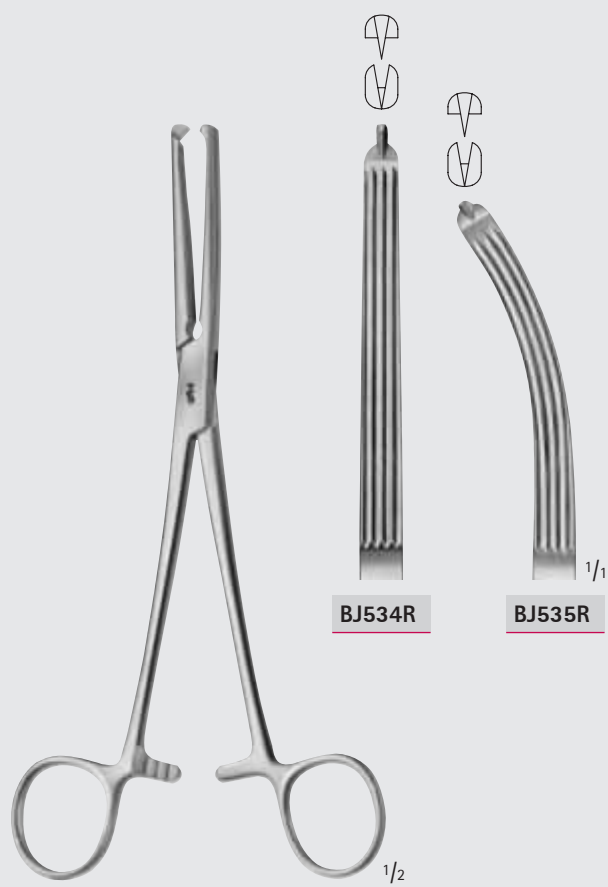

GWILLIAM

BJ534R-BJ535R

200 mm, 8"

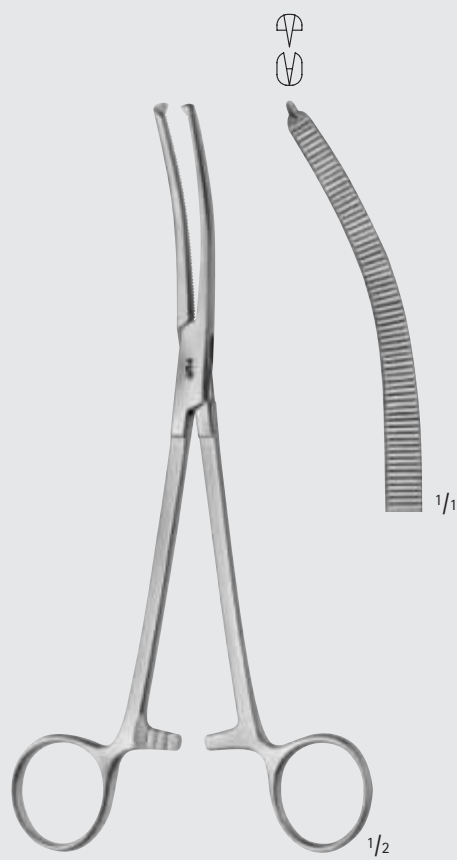

BERKELEY-BONNEY

BJ537R

200 mm, 8"



DE BAKEY Zahnung

Toothing DE BAKEY

ARAUMATA[®]

Klemmen – Forceps
Hysterektomie- und Vaginalklemmen
Hysterectomy Forceps and Vaginal Clamps

BJ



HEANEY

BJ530R-BJ532R



BJ530R
225 mm
9"



BJ531R
220 mm
8 3/4"



BJ532R
215 mm
8 1/2"

MILLIMETERS

Klemmen – Forceps
 Hysterektomie- und Vaginalklemmen
 Hysterectomy Forceps and Vaginal Clamps

DE BAKEY Zahnung

TRAUMATA®

Toothing DE BAKEY

BJ



WERTHEIM

BJ550R-BJ553R



BJ550R
 250 mm
 10"



BJ551R
 245 mm
 9 3/4"



BJ552R
 240 mm
 9 1/2"

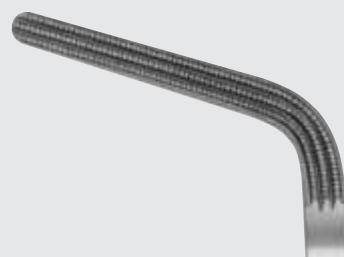

BJ553R
 220 mm
 8 3/4"

1/1



DE BAKEY Zahnung

Toothings DE BAKEY

ARAUMATA[®]

Klemmen – Forceps
Hysterektomie- und Vaginalklemmen
Hysterectomy Forceps and Vaginal Clamps

BJ

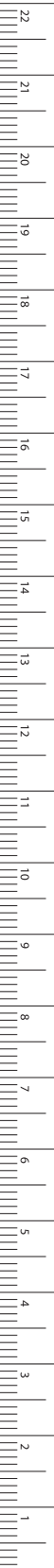

MILLIMETERS

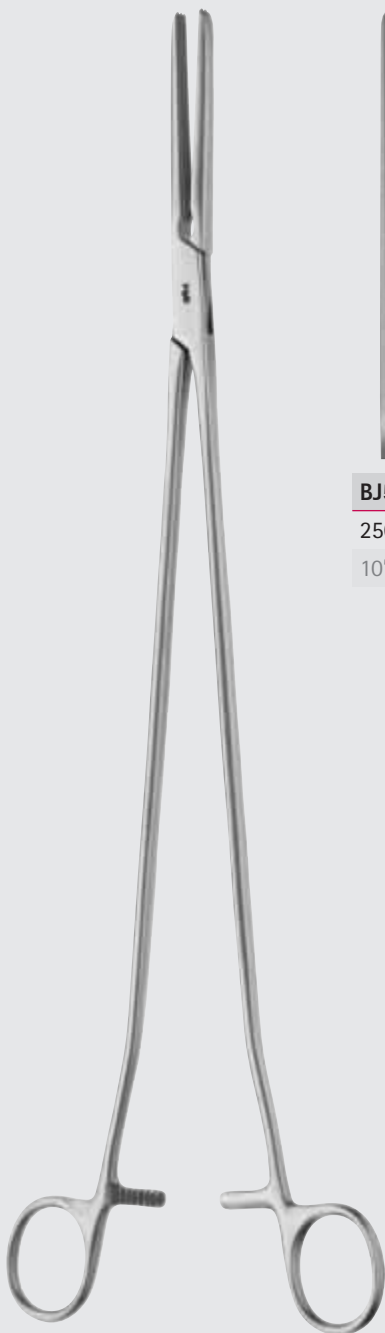

BJ582R

250 mm

10"



BJ584R

350 mm

14"



BJ583R

250 mm

10"



BJ585R

350 mm

14"

¹/₁

WERTHEIM

BJ582R-BJ585R

Klemmen – Forceps

Hysterektomie- und Vaginalklemmen

Hysterectomy Forceps and Vaginal Clamps

BJ



WERTHEIM

BJ574R

255 mm, 10"



WERTHEIM

BJ576R

260 mm, 10 1/4"



Klemmen – Forceps
 Hysterektomie- und Vaginalklemmen
 Hysterectomy Forceps and Vaginal Clamps

BJ

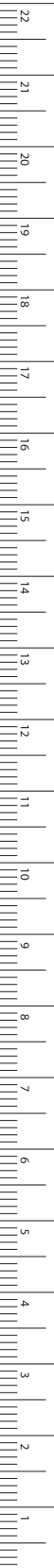

MILLIMETERS



BJ560R	BJ562R
250 mm	350 mm
10"	14"

BURKE
BJ560R-BJ562R
 Parametriumklemme, kurzes Maul
 Parametrium clamp, short jaw part



BJ561R	BJ563R
250 mm	350 mm
10"	14"

BURKE
BJ561R-BJ563R
 Parametriumklemme, langes Maul
 Parametrium clamp, long jaw part

Klemmen – Forceps

Klemmzangen

Clamps and Compression Forceps

DE BAKEY Zahnung

AIRAUMATA®

Toothings DE BAKEY

BJ



FB956R	FB957R	FB958R
255 mm	265 mm	275 mm
10"	10 1/2"	10 3/4"

DICK

FB956R-FB958R

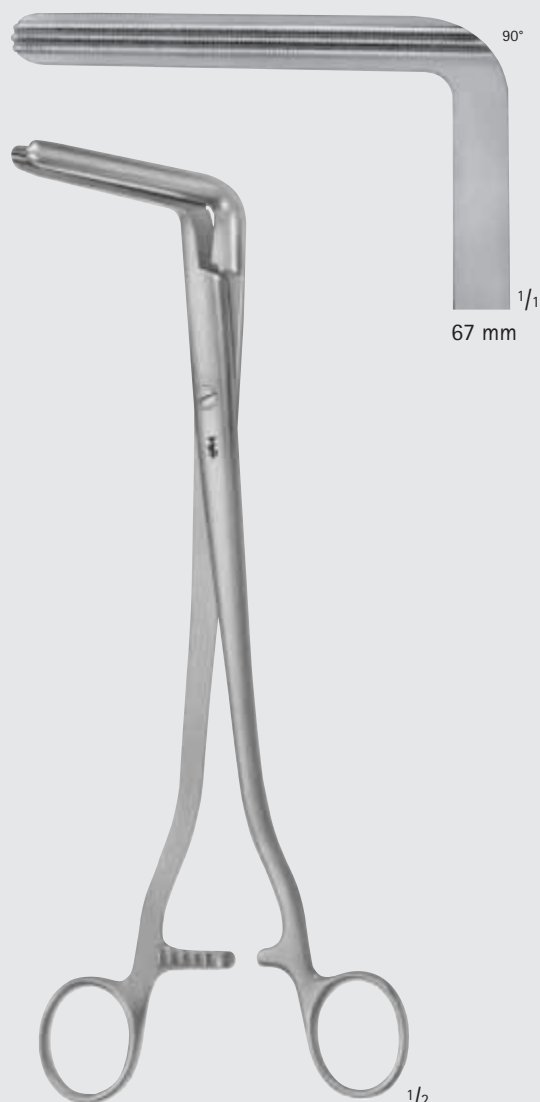

WERTHEIM

BJ581R

250 mm, 10"



Klemmen – Forceps
 Klemmzangen
 Clamps and Compression Forceps

BJ

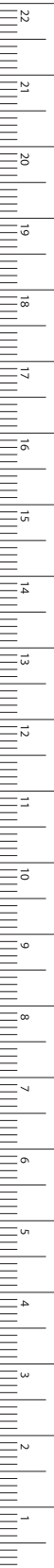

MILLIMETERS



WERTHEIM-CULLEN

BJ579R

215 mm, 8 1/2"



FB954R
60 mm

FB955R
80 mm

FB954R-FB955R

230 mm, 9"



INCHES



BL



Nähnadeln, Nadeldosen
Surgical Needles, Needle Cases

Nähnadeln, Nähnosen – Surgical Needles, Needle Cases

Chirurgische Nähnadeln

Surgical Needles

BL

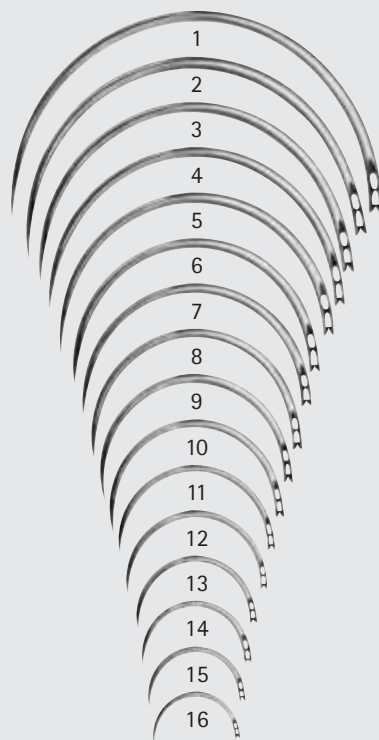
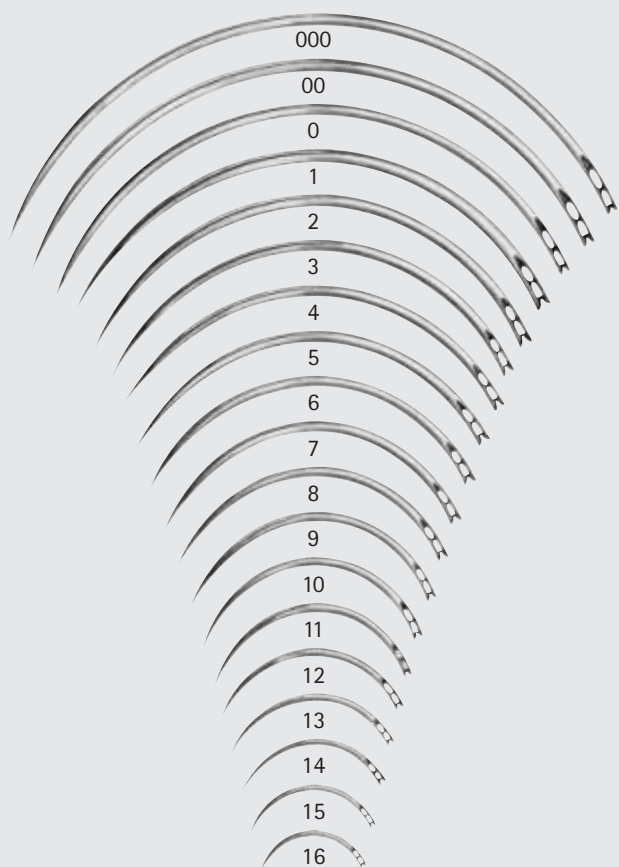



Fig.	● 	Ø x Länge Diam. x length	▲ 	Ø x Länge Diam. x length
000	BL058N	1,60 x 102 mm	BL098N	1,60 x 102 mm
00	BL059N	1,60 x 94 mm	BL099N	1,60 x 94 mm
0	BL060N	1,60 x 85 mm	BL100N	1,60 x 85 mm
1	BL061N	1,40 x 80 mm	BL101N	1,40 x 80 mm
2	BL062N	1,40 x 73 mm	BL102N	1,40 x 73 mm
3	BL063N	1,30 x 68 mm	BL103N	1,30 x 68 mm
4	BL064N	1,30 x 63 mm	BL104N	1,30 x 63 mm
5	BL065N	1,20 x 58 mm	BL105N	1,20 x 58 mm
6	BL066N	1,10 x 54 mm	BL106N	1,10 x 54 mm
7	BL067N	1,10 x 50 mm	BL107N	1,10 x 50 mm
8	BL068N	1,00 x 46 mm	BL108N	1,00 x 46 mm
9	BL069N	1,00 x 42 mm	BL109N	1,00 x 42 mm
10	BL070N	0,90 x 38 mm	BL110N	0,90 x 38 mm
11	BL071N	0,80 x 34 mm	BL111N	0,80 x 34 mm
12	BL072N	0,70 x 30 mm	BL112N	0,70 x 30 mm
13	BL073N	0,70 x 27 mm	BL113N	0,70 x 27 mm
14	BL074N	0,70 x 23 mm	BL114N	0,70 x 23 mm
15	BL075N	0,60 x 20 mm	BL115N	0,60 x 20 mm
16	BL076N	0,60 x 18 mm	BL116N	0,60 x 18 mm

● 	Ø x Länge Diam. x length	▲ 	Ø x Länge Diam. x length
BL161N	1,40 x 80 mm	BL201N	1,40 x 80 mm
BL162N	1,40 x 73 mm	BL202N	1,40 x 73 mm
BL163N	1,30 x 68 mm	BL203N	1,30 x 68 mm
BL164N	1,30 x 63 mm	BL204N	1,30 x 63 mm
BL165N	1,20 x 58 mm	BL205N	1,20 x 58 mm
BL166N	1,10 x 54 mm	BL206N	1,10 x 54 mm
BL167N	1,10 x 50 mm	BL207N	1,10 x 50 mm
BL168N	1,00 x 46 mm	BL208N	1,00 x 46 mm
BL169N	1,00 x 42 mm	BL209N	1,00 x 42 mm
BL170N	0,90 x 38 mm	BL210N	0,90 x 38 mm
BL171N	0,80 x 34 mm	BL211N	0,80 x 34 mm
BL172N	0,70 x 30 mm	BL212N	0,70 x 30 mm
BL173N	0,70 x 27 mm	BL213N	0,70 x 27 mm
BL174N	0,70 x 23 mm	BL214N	0,70 x 23 mm
BL175N	0,60 x 20 mm	BL215N	0,60 x 20 mm
BL176N	0,60 x 18 mm	BL216N	0,60 x 18 mm



Nähnadeln, Nähnosen – Surgical Needles, Needle Cases

Chirurgische Nähnadeln Surgical Needles

Nähnadeln

Bestelleinheit: **PAK** = Packung à 12 Stück

Suture needles

Sales unit: Package of 12 pieces

BL

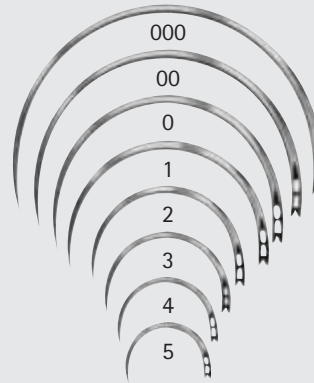
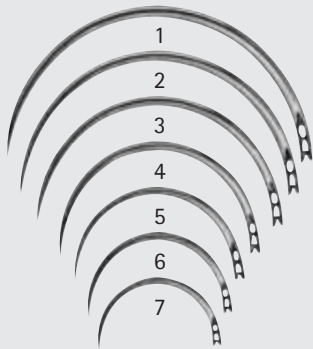

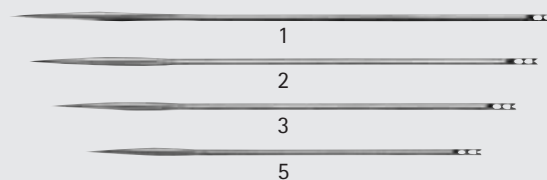

Fig.		Ø x Länge Diam. x length		Ø x Länge Diam. x length
000				
00				
0				
1	BL231N	1,60 x 65 mm	BL251N	1,60 x 65 mm
2	BL232N	1,60 x 60 mm	BL252N	1,60 x 60 mm
3	BL233N	1,40 x 52 mm	BL253N	1,40 x 52 mm
4	BL234N	1,40 x 45 mm	BL254N	1,40 x 45 mm
5	BL235N	1,30 x 37 mm	BL255N	1,30 x 37 mm
6	BL236N	1,10 x 32 mm	BL256N	1,10 x 32 mm
7	BL237N	1,00 x 26 mm	BL257N	1,00 x 26 mm

Fig.		Ø x Länge Diam. x length
BL318N		1,10 x 72 mm
BL319N		1,10 x 63 mm
BL320N		1,00 x 54 mm
BL321N		1,00 x 45 mm
BL322N		0,90 x 36 mm
BL323N		0,80 x 29 mm
BL324N		0,70 x 23 mm
BL325N		0,60 x 20 mm

Fig.		Ø x Länge Diam. x length
1	BL301N	0,80 x 75 mm
2	BL302N	0,80 x 70 mm
3	BL303N	0,80 x 65 mm
5	BL305N	0,70 x 55 mm

KEITH



MILLIMETERS

Nähnadeln, Nähösen – Surgical Needles, Needle Cases

Chirurgische Nadeln und Nähmaterial

Surgical Needles and Suture Material

Nähnadeln

Bestelleinheit: **PAK** = Packung à 12 Stück

Suture needles

Sales unit: Package of 12 pieces

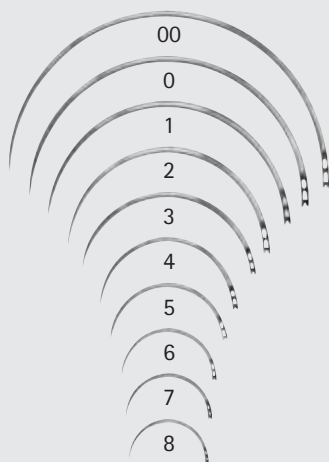

Darmnadeln

Intestinal needles

Fig.		Ø x Länge Diam. x length
00	BL539N	0,70 x 68 mm
0	BL540N	0,70 x 60 mm
1	BL541N	0,70 x 52 mm
2	BL542N	0,70 x 42 mm
3	BL543N	0,60 x 36 mm
4	BL544N	0,60 x 30 mm
5	BL545N	0,60 x 24 mm
6	BL546N	0,60 x 22 mm
7	BL547N	0,60 x 20 mm
8	BL548N	0,60 x 18 mm



Augennadeln

Eye needles

	Ø x Länge Diam. x length
BL601N	0,60 x 30 mm
BL602N	0,60 x 24 mm
BL603N	0,60 x 20 mm
BL604N	0,60 x 15 mm
BL605N	0,60 x 12 mm



Augennadeln

Eye needles

	Durchmesser x Länge
BL611N	0,60 x 30 mm
BL612N	0,60 x 24 mm
BL613N	0,60 x 19 mm
BL614N	0,60 x 15 mm
BL615N	0,60 x 12 mm

BL





Nähnadeln, Nähdosens – Surgical Needles, Needle Cases

Nadeldosen
Needle Cases

BL



BL907R

70 x 53 x 9 mm



BL941R

150 x 90 x 10 mm



BL910R 50 x 25 x 5 mm

BL911R 50 x 30 x 6 mm

BL915R 75 x 25 x 5 mm



BL943R

205 x 120 x 12 mm



BL930R Nadeldose mit Innendose Needle case with interior box 65 x 16 mm

BL932R Nadeldose mit Innendose Needle case with interior box 95 x 16 mm

BL929R Außendose von BL930R allein Exterior box of BL930R only 65 x 16 mm

BL931R Innendose von BL930R allein Interior box of BL930R only 62 x 17 mm

BL933R Innendose von BL932R allein Interior box of BL932R only 90 x 17 mm



MILLIMETERS



INCHES

BM



**Nadelhalter, Naht-Instrumente,
Unterbindungsnadeln und Hohlsonden**
Needle Holders, Suture Instruments,
Ligature Needles, Guiding Probes

Nadelhalter – Needle Holders

Mikro-Nadelhalter mit Flachgriff

Micro Needle Holders with Flat Handles

BM



BM563R



BM564R

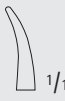

1/2

CASTROVIEJO

BM563R-BM564R

mit Sperre
with catch

145 mm, 5 3/4"



FD076R



FD079R



1/2

FD076R-FD079R

ohne Sperre
without catch

160 mm, 6 1/4"

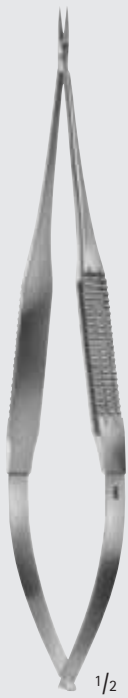

FD080R



FD081R



1/2

FD080R-FD081R

ohne Sperre
without catch

185 mm, 7 1/4"



FD045R



FD046R



ohne Sperre
without catch

mit Sperre
with catch

1/2

JACOBSON

FD045R-FD046R

185 mm, 7 1/4"



1/1

1/2

FD048R

mit Sperre
with catch

200 mm, 8"





Nadelhalter – Needle Holders

Mikro-Nadelhalter mit Rundgriffen

Micro Needle Holders with Round Handles

BM

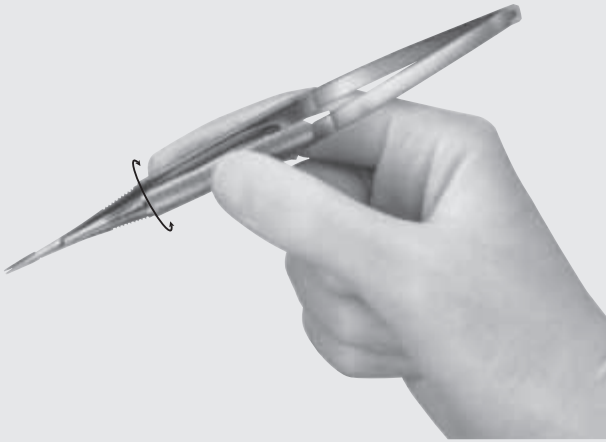

... mit Rundgriffen

- Rundgriffe erlauben Drehbewegungen zwischen den Fingern.
- Optimale Balance, individuell je nach Instrument, durch volle oder gehöhlte Griffpartien.

... with round handles

- Round handles allow turning manipulations between the fingers.
- Optimum balance individually for each instrument due to solid or hollowed-out handles.

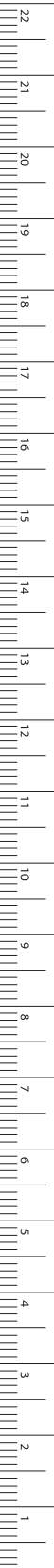

MILLIMETERS



BARRAQUER

BM560R-BM562R

ohne Sperre
without catch

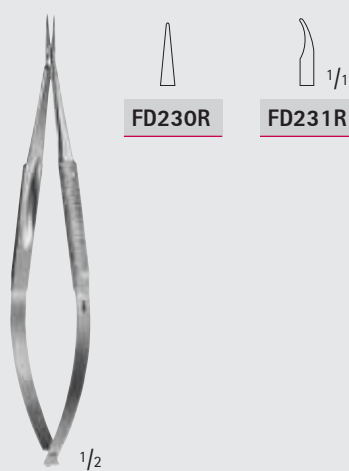

BARRAQUER

FD230R-FD231R

ohne Sperre
without catch
120 mm, 4 3/4"

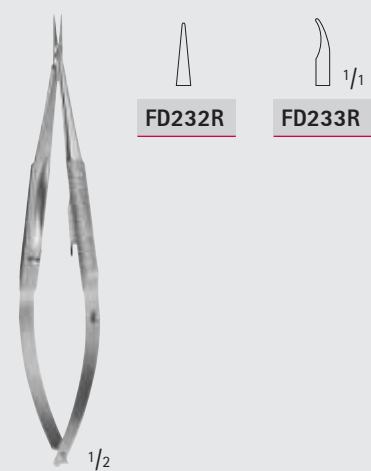

BARRAQUER

FD232R-FD233R

mit Sperre
with catch
120 mm, 4 3/4"

Nadelhalter – Needle Holders

Mikro-Nadelhalter mit Rundgriffen

Micro Needle Holders with Round Handles

BM



FD240R

FD241R

1/2

REILL

FD240R-FD241R

ohne Sperre

without catch

150 mm, 6"



FD242R

FD243R

1/2

FD242R-FD243R

mit Sperre

with catch

150 mm, 6"



FD244R

FD245R

1/2

FD244R-FD245R

ohne Sperre

without catch

185 mm, 7 1/4"



FD246R

FD247R

1/2

FD246R-FD247R

mit Sperre

with catch

185 mm, 7 1/4"



Nadelhalter – Needle Holders

Mikro-Nadelhalter mit leichtem Kunststoffgriffprofil
Micro Needle Holders with Lightweight Plastic Handles



Das MÜLLER Mikro-Instrumentarium

Ein hochwertiges Set für die periphere Mikrochirurgie. Zahlreiche praxisbewährte Details führen zu mehr Effektivität und Sicherheit.

■ Unverkrampte Haltung = mehr Feingefühl

Das leichte Kunststoffprofil vergrößert die Griffoberfläche, gewährleistet dadurch eine unverkrampte Handhaltung und verleiht mehr Feingefühl.

■ Leichteres Drehen = erweiterter Arbeitsbereich

Der runde Griffquerschnitt ermöglicht leichtes, gleichmäßiges Drehen des Instrumentes. Verwendungs- bzw. Arbeitsbereich wird dadurch erweitert.

■ Sicherer Halt

Das griffige Noppenprofil gewährleistet einen durchweg sicheren Halt bei sämtlichen Bewegungsabläufen.

■ Optimales Handling

Eine Entwicklung nach ergonomischen Gesichtspunkten, verbunden mit dem geringen Gewicht der neuen Kunststoffgriffe schaffen die Voraussetzung zu ermüdungsfreiem Arbeiten und optimalem Handling.

The MÜLLER Micro instrument system

A top quality set for peripheral microsurgery. Numerous details tried and tested in practice mean increased efficiency and safety.

■ Natural holding position = increased sensitivity

The light plastic profile increases the grip surface, thus guaranteeing a natural hand position without cramping and providing enhanced sensitivity.

■ Easier rotation = extended working area

The round grip cross section permits easy and uniform rotation of the instrument. This extends the application and working areas.

■ Safe grip

The easy grip studded profile guarantees a secure hold for all movements.

■ Optimum handling

Development in accordance with ergonomic criteria and the low weight of the new plastic grips provide fatiguefree working and optimum handling.



MÜLLER

FM021R

145 mm, 5 3/4"



MÜLLER

FM061R

180 mm, 7"

Nadelhalter – Needle Holders
 DUROGRIP® Mikro-Nadelhalter
 DUROGRIP® Micro Needle Holders



BM

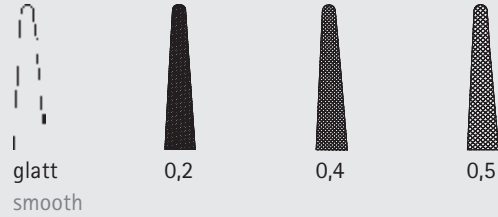
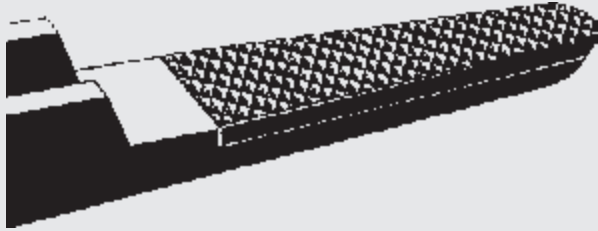

AESCULAP-Nadelhalter sind durch die Struktur der Hartmetall-Maulteile auf das jeweilige, indikationsbezogene Nahtmaterial abgestimmt. Eine glatte Maulfläche sowie 3 verschiedene Haftprofile garantieren den sicheren „Griff“ der jeweiligen Nadel.

AESCULAP needle holders have jaws with carbide inserts and according to the use required the resp. structure can be chosen. A smooth jaw surface as well as 3 different serrations guarantee a sure „grip“ of the resp. needle.

Wir empfehlen Hartmetall-Maulteile mit glatter Fläche für Nahtmaterial mit Teilung 0,2 mm für Nahtmaterial 0,4 mm 0,5 mm

9/0 – 11/0
 6/0 – 10/0
 4/0 – 6/0
 bis 3/0

We recommend carbide inserts with smooth jaw surface for suture material with 0.2 mm pitch of serration for suture material 0.4 mm 0.5 mm

9/0 – 11/0
 6/0 – 10/0
 4/0 – 6/0
 up to 3/0



DUROGRIP®-Nadelhalter mit Hartmetall-Plättchen
Kennzeichnung:
Vergoldete Ringe, Branchenenden und Sperren
 DUROGRIP® Needle Holders with carbide inserts
Identification:
 gold-plated rings, handle ends and ratchets

 1/1
 mit glattem Maul
 with smooth jaw



CASTROVIEJO
BM001R
 145 mm, 5 3/4"

 1/1
 0,2



CASTROVIEJO
BM002R
 145 mm, 5 3/4"

 1/1
 0,4



BM003R
 170 mm, 6 3/4"



Nadelhalter – Needle Holders
 DUROGRIP Mikro-Nadelhalter
 DUROGRIP Micro Needle Holders

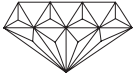

BM

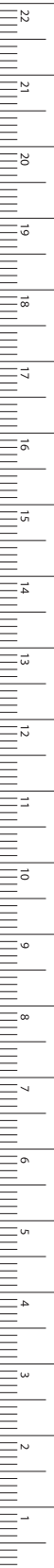

MILLIMETERS



CASTROVIEJO

BM004R

180 mm, 7"



CASTROVIEJO

BM005R

215 mm, 8 1/2"



FM388R

mit Sperre
with catch
180 mm, 7"



FM390R

mit Sperre
with catch
200 mm, 8"

DIADUST



Nadelhalter – Needle Holders

DIADUST Mikro-Nadelhalter mit Rundgriff

DIADUST Micro Needle Holders with Round Handle

DIADUST



Die Diamantstaubbeschichtung sorgt für eine noch härtere und verschleißfestere Maulinnenfläche. Darüber hinaus garantiert die Struktur der DIADUST-Beschichtung ein zuverlässiges Fassen von feinen Nadeln und Nahtmaterialien sowie von Weichgewebe.

The diamond dust coating ensures an even harder and more wear resistant surface on the inside of the jaws. Moreover, the structure of the DIADUST coating guarantees a reliable grip for fine needles and sutures, as well as for tissue.

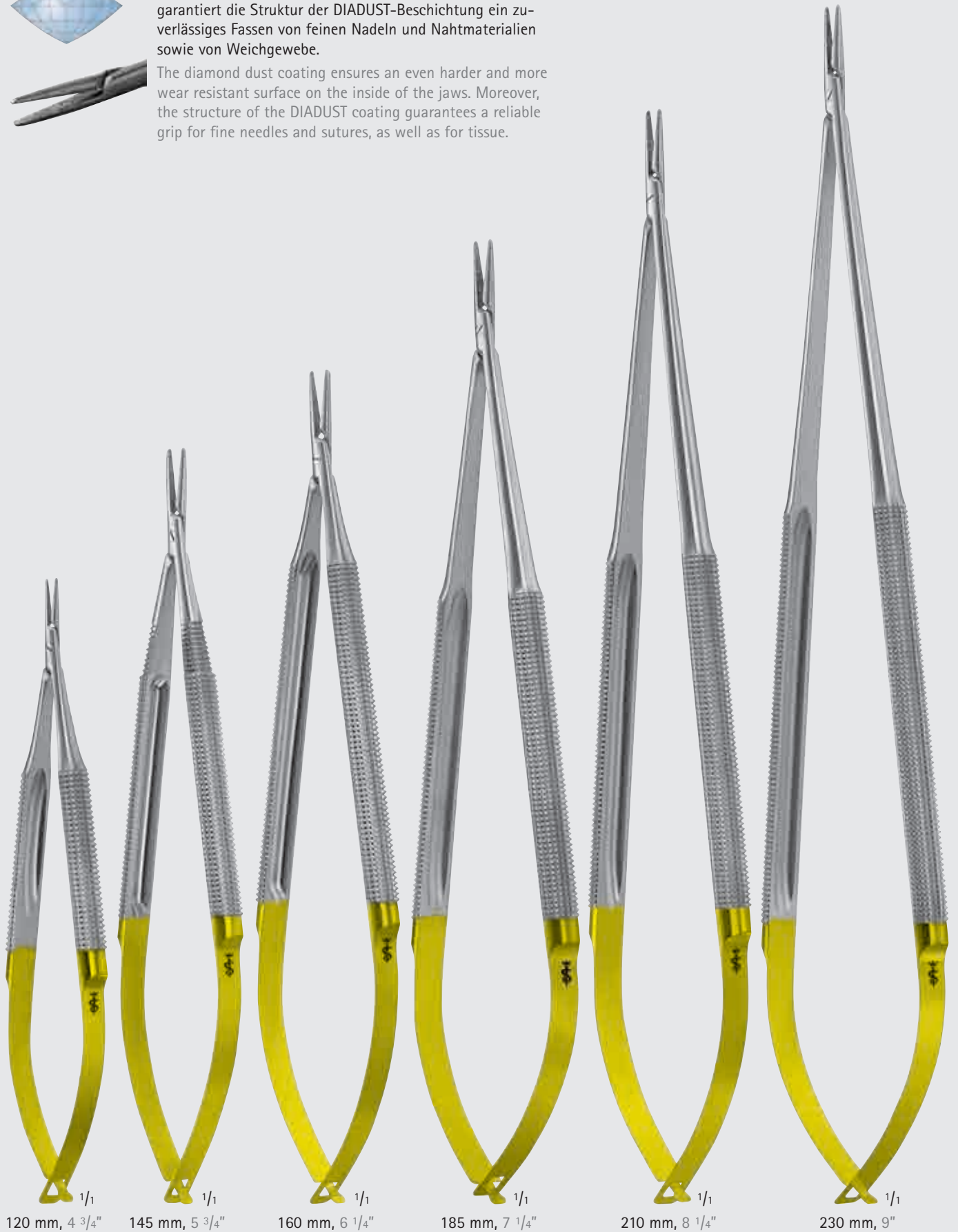

BM



DIADUST



Nadelhalter – Needle Holders

DIADUST Mikro-Nadelhalter mit Rundgriff
DIADUST Micro Needle Holders with Round Handle

BM

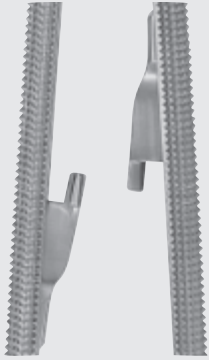

mit Sperre
with ratchet



Nahtmaterialgröße
Suture size

Länge (mm) Length (in.)	7/0 und kleiner 7/0 and smaller	5/0 und kleiner 5/0 and smaller	4/0 und kleiner 4/0 and smaller	4/0 und kleiner 4/0 and smaller
120 mm 4 3/4"	FM520R			
145 mm 5 3/4"		FM522R		
160 mm 6 1/4"	FM521R	FM523R		
185 mm 7 1/4"	FM563R	FM564R	FM218R	
210 mm 8 1/4"	FM565R	FM566R	FM228R	FM221R
230 mm 9"	FM567R	FM568R	FM230R	FM223R

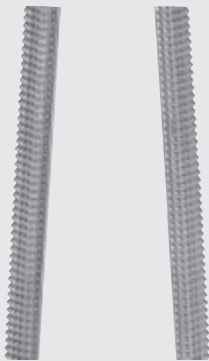

ohne Sperre
without
ratchet



Nahtmaterialgröße
Suture size

Länge (mm) Length (in.)	7/0 und kleiner 7/0 and smaller	5/0 und kleiner 5/0 and smaller
120 mm 4 3/4"	FM524R	
145 mm 5 3/4"		FM528R
160 mm 6 1/4"	FM525R	FM529R
185 mm 7 1/4"	FM526R	FM530R
210 mm 8 1/4"	FM527R	FM531R
230 mm 9"	FM532R	FM533R

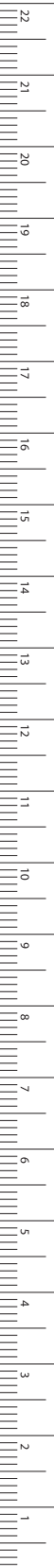

MILLIMETERS

Nadelhalter – Needle Holders

DIADUST Mikro-Nadelhalter mit Rundgriff

DIADUST Micro Needle Holders with Round Handle

DIADUST



Die Diamantstaubbeschichtung sorgt für eine noch härtere und verschleißfestere Maulinnenfläche. Darüber hinaus garantiert die Struktur der DIADUST-Beschichtung ein zuverlässiges Fassen von feinen Nadeln und Nahtmaterialien sowie von Weichgewebe.

The diamond dust coating ensures an even harder and more wear resistant surface on the inside of the jaws. Moreover, the structure of the DIADUST coating guarantees a reliable grip for fine needles and sutures, as well as for tissue.



190 mm, 7 1/2"

230 mm, 9"

250 mm, 10"

BM





DIADUST



Nadelhalter – Needle Holders DIADUST Mikro-Nadelhalter mit Rundgriff DIADUST Micro Needle Holders with Round Handle

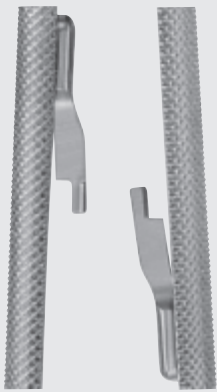

mit Sperre,
kräftige
Ausführung
with ratchet,
heavy style

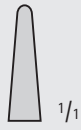

Nahtmaterialgröße
Suture size

Länge (mm)
Length (in.)

190 mm
7 1/2" **FM538R**

230 mm
9" **FM539R**

250 mm
10" **FM534R**

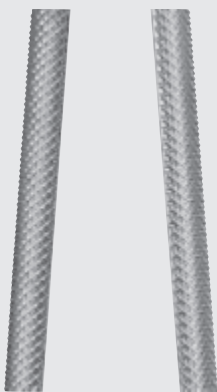

ohne Sperre,
kräftige
Ausführung
without
ratchet,
heavy style



Nahtmaterialgröße
Suture size

Länge (mm)
Length (in.)

190 mm
7 1/2" **FM535R**

230 mm
9" **FM536R**

250 mm
10" **FM537R**

BM

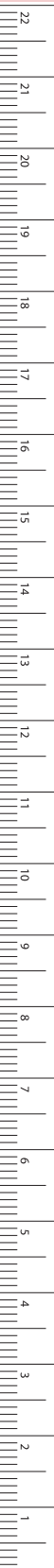

MILLIMETERS

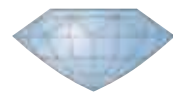

Nadelhalter – Needle Holders

DIADUST Mikro-Nadelhalter mit Flachgriff

DIADUST Micro Needle Holders with Flat Handles

DIADUST



Die Diamantstaubbeschichtung sorgt für eine noch härtere und verschleißfestere Maulinnenfläche. Darüber hinaus garantiert die Struktur der DIADUST-Beschichtung ein zuverlässiges Fassen von feinen Nadeln und Nahtmaterialien sowie von Weichgewebe.

The diamond dust coating ensures an even harder and more wear resistant surface on the inside of the jaws. Moreover, the structure of the DIADUST coating guarantees a reliable grip for fine needles and sutures, as well as for tissue.



145 mm, 5 ³/₄"

170 mm, 6 ³/₄"

185 mm, 7 ¹/₄"

210 mm, 8 ¹/₄"

230 mm, 9"



DIADUST



Nadelhalter – Needle Holders DIADUST Mikro-Nadelhalter mit Flachgriff DIADUST Micro Needle Holders with Flat Handles

BM

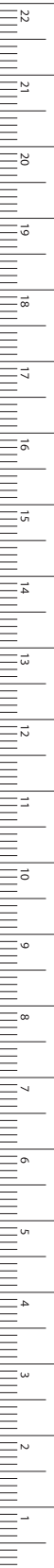

MILLIMETERS

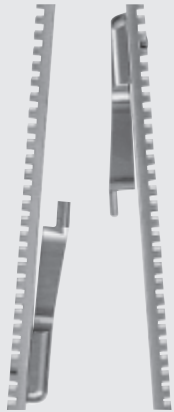

mit Sperre
with ratchet



Nahtmaterialgröße
Suture size

Länge (mm) Length (in.)	7/0 und kleiner 7/0 and smaller	5/0 und kleiner 5/0 and smaller
145 mm 5 3/4"		FM541R
170 mm 6 3/4"	FM540R	
185 mm 7 1/4"		FM542R
210 mm 8 1/4"		FM543R
230 mm 9"		FM544R

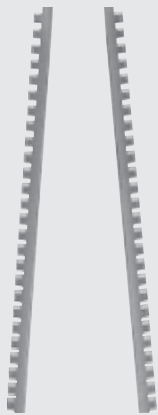

ohne Sperre
without
ratchet



Nahtmaterialgröße
Suture size

Länge (mm) Length (in.)	7/0 und kleiner 7/0 and smaller	5/0 und kleiner 5/0 and smaller
145 mm 5 3/4"		FM546R
170 mm 6 3/4"	FM545R	
185 mm 7 1/4"		FM547R
210 mm 8 1/4"		FM548R
230 mm 9"		FM549R

DIADUST

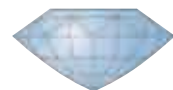

Nadelhalter – Needle Holders

DIADUST Mikro-Nadelhalter mit Flachgriff

DIADUST Micro Needle Holder with Flat Knurled Handle

DIADUST



Die Diamantstaubbeschichtung sorgt für eine noch härtere und verschleißfestere Maulinnenfläche. Darüber hinaus garantiert die Struktur der DIADUST-Beschichtung ein zuverlässiges Fassen von feinen Nadeln und Nahtmaterialien sowie von Weichgewebe.

The diamond dust coating ensures an even harder and more wear resistant surface on the inside of the jaws. Moreover, the structure of the DIADUST coating guarantees a reliable grip for fine needles and sutures, as well as for tissue.



185 mm, 7 $\frac{1}{4}$ "

210 mm, 8 $\frac{1}{4}$ "

230 mm, 9"

BM





DIADUST



Nadelhalter – Needle Holders

DIADUST Mikro-Nadelhalter mit Flachgriff
DIADUST Micro Needle Holders with Flat Knurled Handle

BM



mit Sperre
with ratchet



Nahtmaterialgröße
Suture size

Länge (mm) Length (in.)	5/0 und kleiner 5/0 and smaller
185 mm 7 1/4"	FM550R
210 mm 8 1/4"	FM551R
230 mm 9"	FM552R



ohne Sperre
without
ratchet



Nahtmaterialgröße
Suture size

Länge (mm) Length (in.)	5/0 und kleiner 5/0 and smaller
185 mm 7 1/4"	FM553R
210 mm 8 1/4"	FM554R
230 mm 9"	FM555R

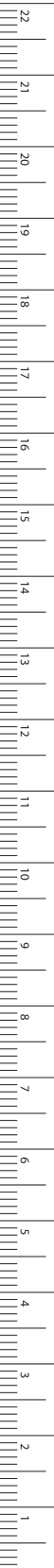

MILLIMETERS

DIADUST

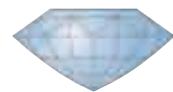

Nadelhalter – Needle Holders

DIADUST Mikro-Nadelhalter

DIADUST Micro Needle Holders

DIADUST



Die Diamantstaubbeschichtung sorgt für eine noch härtere und verschleißfestere Maulinnenfläche. Darüber hinaus garantiert die Struktur der DIADUST-Beschichtung ein zuverlässiges Fassen von feinen Nadeln und Nahtmaterialien sowie von Weichgewebe.

The diamond dust coating ensures an even harder and more wear resistant surface on the inside of the jaws. Moreover, the structure of the DIADUST coating guarantees a reliable grip for fine needles and sutures, as well as for tissue.



GLASSER

FM560R

Nahtmaterialgröße: 5/0 und kleiner
Suture size: 5/0 and smaller
125 mm, 5"



GLASSER

FM561R

Nahtmaterialgröße: 5/0 und kleiner
Suture size: 5/0 and smaller
180 mm, 7"

BM





DIADUST



Nadelhalter – Needle Holders

DIADUST Mikro-Nadelhalter
DIADUST Micro Needle Holders

BM

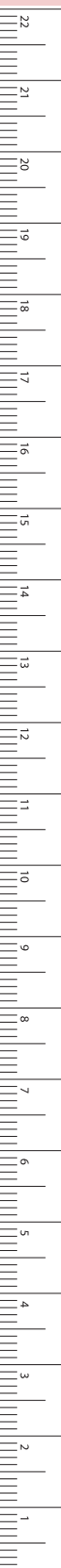

MILLIMETERS



1/2

FD258R-FD259R
180 mm, 7"



1/2

FM236R
mit Sperre
Nahtmaterialgröße: 5/0 und kleiner
with ratchet
Suture size: 5/0 and smaller
210 mm, 8 1/4"



1/2

FM276R
ohne Sperre
Nahtmaterialgröße: 5/0 und kleiner
without ratchet
Suture size: 5/0 and smaller
210 mm, 8 1/4"

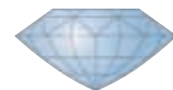

Nadelhalter – Needle Holders

DIADUST Mikro-Nadelhalter

DIADUST Micro Needle Holders

DIADUST



Die Diamantstaubbeschichtung sorgt für eine noch härtere und verschleißfestere Maulinnenfläche. Darüber hinaus garantiert die Struktur der DIADUST-Beschichtung ein zuverlässiges Fassen von feinen Nadeln und Nahtmaterialien sowie von Weichgewebe.

The diamond dust coating ensures an even harder and more wear resistant surface on the inside of the jaws. Moreover, the structure of the DIADUST coating guarantees a reliable grip for fine needles and sutures, as well as for tissue.



BM301R	BM325R	BM302R	BM327R	BM328R
140 mm	160 mm	180 mm	220 mm	250 mm
5 1/2"	6 1/4"	7"	8 3/4"	10"



RYDER

BM301R-BM328R

Nahtmaterialgröße: 5/0 und kleiner

Suture Size: 5/0 and smaller



Nadelhalter – Needle Holders
Nadelhalter
Needle Holders

BM

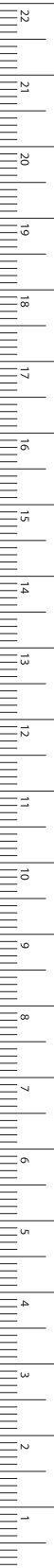

CONVERSE

BM200R

130 mm, 5 1/8"



WEBSTER

BM202R

125 mm, 5"



HALSEY

BM201R-BM205R

130 mm, 5 1/8"



DERF

BM204R

125 mm, 5"



DOYEN

BM210R

125 mm, 5"



BAUMGARTNER

BM215R

145 mm, 5 3/4"

MILLIMETERS

Nadelhalter – Needle Holders

Nadelhalter
Needle Holders

BM



CRILE-WOOD

BM218R

150 mm, 6"

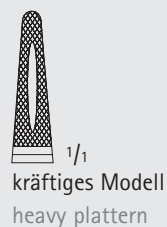
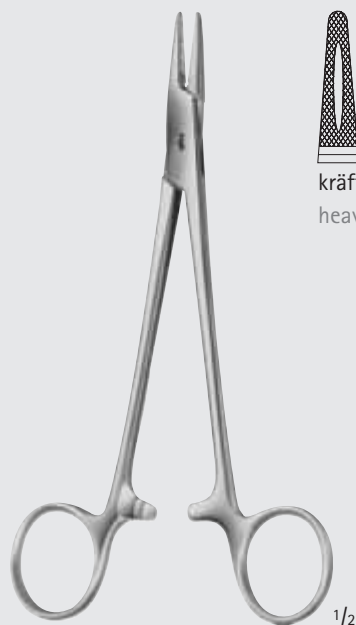

CRILE-WOOD

BM220R

160 mm, 6 1/4"

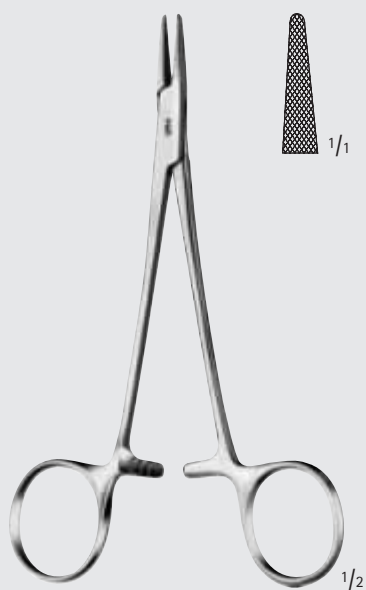

CRILE-MURRAY

BM219R

150 mm, 6"



KILNER

BM211R

135 mm, 6"



Nadelhalter – Needle Holders

Nadelhalter Needle Holders

BM



1/1
feines Maul
delicate jaw

LAWRANCE

BM221R

150 mm, 6"



1/1
für Frontal-, Gaumennaht
etc. geeignet
designed for frontal and
palate suture

ADSON

BM224R

180 mm, 7"

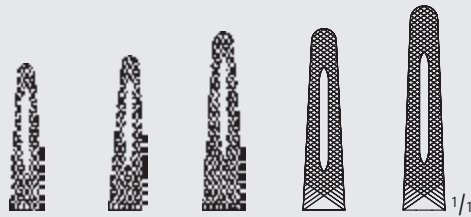

BM235R	BM236R	BM237R	BM238R	BM240R
150 mm	185 mm	200 mm	235 mm	265 mm
6"	7 1/4"	8"	9 1/4"	10 1/2"

MAYO-HEGAR

BM235R-BM240R

mittelfeine Modelle
medium fine patterns

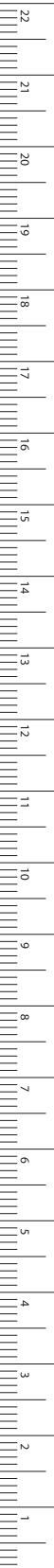

MILLIMETERS

Nadelhalter – Needle Holders

Nadelhalter
Needle Holders

BM

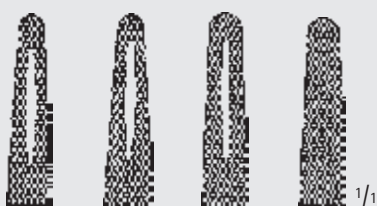

BM245R	BM247R	BM249R	BM255R
150 mm	175 mm	205 mm	205 mm
6"	7"	8"	8"

HEGAR

BM245R-BM255R

kräftige Modelle
heavy patterns



BM241R	BM242R
165 mm	190 mm
6 1/2"	7 1/2"

MAYO-HEGAR

BM241R-BM242R



HEANEY

BM259R

200 mm, 8"



JAMESON

BM270R

230 mm, 9"



Nadelhalter – Needle Holders
Nadelhalter
Needle Holders

BM



WANGENSTEEN

BM272R

275 mm, 10 ³/₄"



MASSON

BM275R

265 mm, 10 ¹/₂"

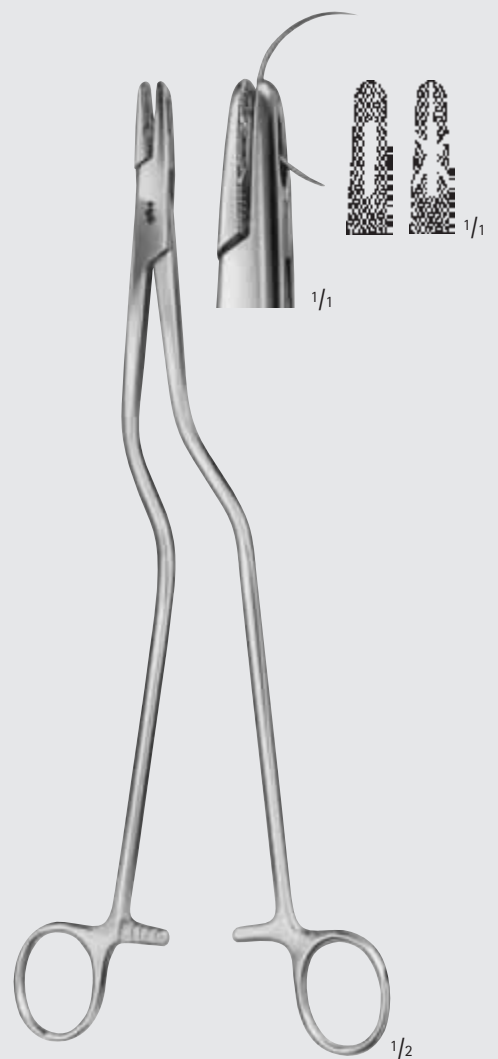

MASSON-LUETHY

BM280R

255 mm, 10"

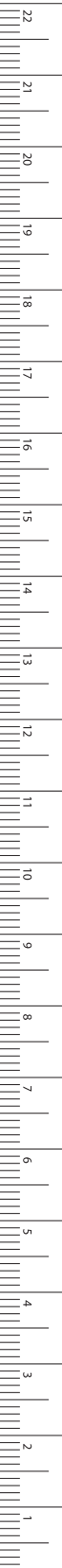

MILLIMETERS

Nadelhalter – Needle Holders

Nadelhalter mit Schere

Needle Holders with Scissors

BM



BM290R	BM291R
140 mm	185 mm
5 1/2"	7 1/4"

HEGAR-OLSEN

BM290R-BM291R

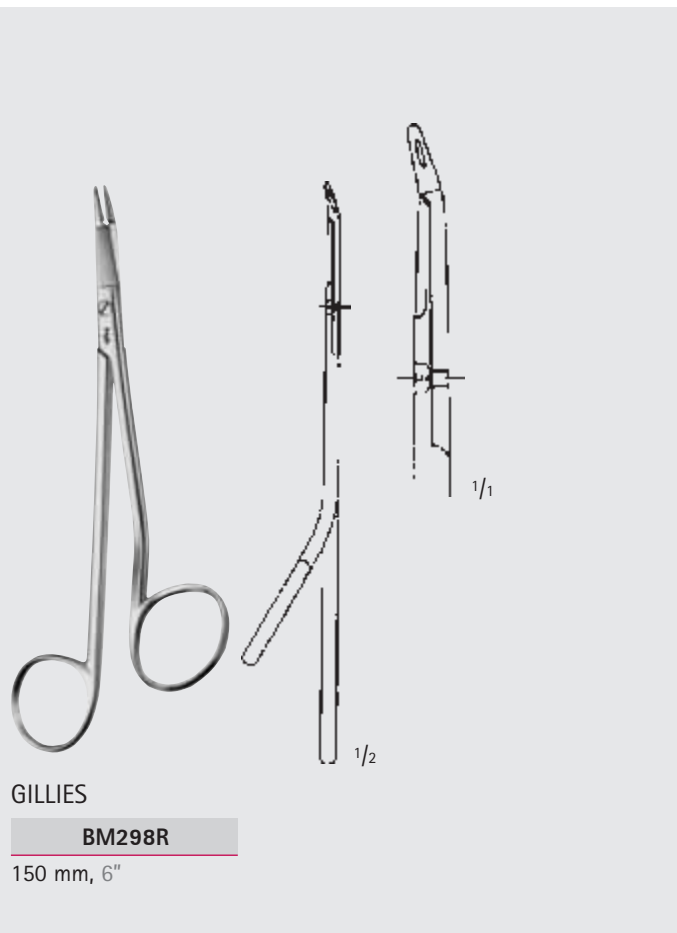

GILLIES

BM298R

150 mm, 6"



GILLIES

BM299R

160 mm, 6 1/4"



Nadelhalter – Needle Holders

Nadelhalter Needle Holders

BM

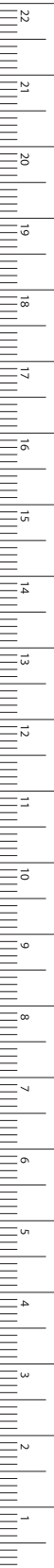

MILLIMETERS



CRILE

BM503R

150 mm, 6"



TÖNNIS

BM510R

elastisches Modell für Dura- oder Darmnaht
elastic pattern for dura- or intestinal suture
180 mm, 7"



BM360R	BM361R	BM362R
140 mm	170 mm	200 mm
5 1/2"	6 3/4"	8"

MATHIEU

BM360R-BM362R



BM406R	BM407R
175 mm	200 mm
7"	8"

MATHIEU-STILLE

BM406R-BM407R

sehr kräftige Modelle
very heavy patterns

Nadelhalter – Needle Holders

DUROGRIP® Nadelhalter

DUROGRIP® Needle Holders

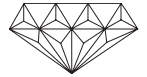

BM

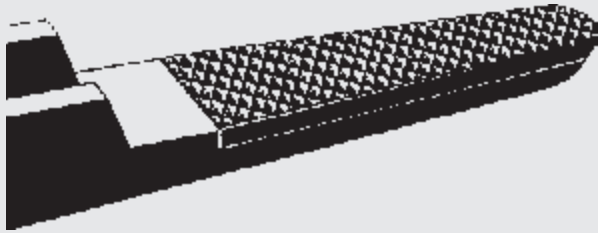

glatt
smooth



0,2



0,4



0,5

AESULAP-Nadelhalter sind durch die Struktur der Hartmetall-Maulteile auf das jeweilige, indikationsbezogene Nahtmaterial abgestimmt. Eine glatte Maulfläche sowie 3 verschiedene Haftprofile garantieren den sicheren „Griff“ der jeweiligen Nadel.

AESULAP needle holders have jaws with carbide inserts and according to the use required the resp. structure can be chosen. A smooth jaw surface as well as 3 different serrations guarantee a sure „grip“ of the resp. needle.

Wir empfehlen Hartmetall-Maulteile mit glatter Fläche für Nahtmaterial mit Teilung 0,2 mm für Nahtmaterial 0,4 mm 0,5 mm

9/0 – 11/0
6/0 – 10/0
4/0 – 6/0
bis 3/0

We recommend carbide inserts with smooth jaw surface for suture material with 0.2 mm pitch of serration for suture material 0.4 mm 0.5 mm

9/0 – 11/0
6/0 – 10/0
4/0 – 6/0
up to 3/0



DUROGRIP®-Nadelhalter mit Hartmetall-Plättchen

Kennzeichnung:

Vergoldete Ringe, Branchenenden und Sperren

DUROGRIP® Needle Holders with carbide inserts

Identification:

gold-plated rings, handle ends and ratchets



Nadelhalter – Needle Holders
DUROGRIP® Nadelhalter
DUROGRIP® Needle Holders

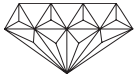

BM

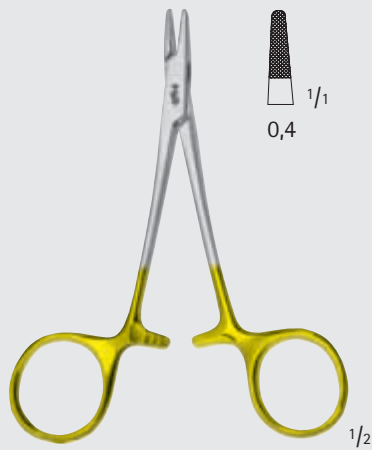
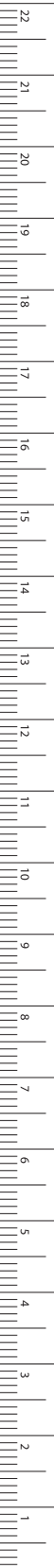

DERF

BM008R

115 mm, 4 1/2"



HALSEY

BM010R

120 mm, 4 3/4"

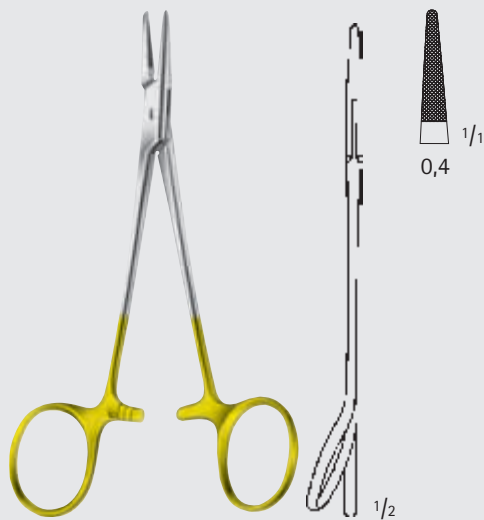

MASING

BM009R

ein Ring abgewinkelt
 one ring angled
 130 mm, 5 1/8"

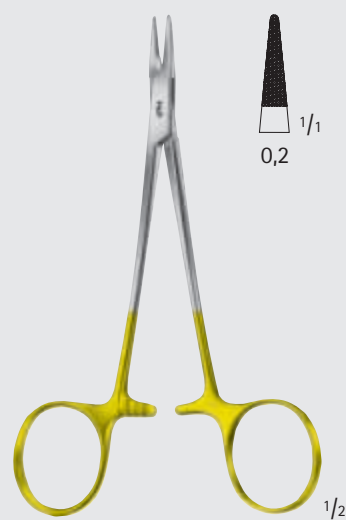

CONVERSE

BM011R

130 mm, 5 1/8"

MILLIMETERS

Nadelhalter – Needle Holders

DUROGRIP® Nadelhalter

DUROGRIP® Needle Holders

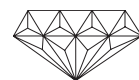

BM

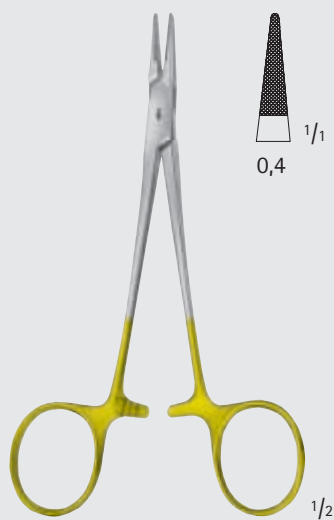

HALSEY

BM012R

130 mm, 5 1/8"



WEBSTER

BM014R-BM024R

125 mm, 5"

BM014R

mit glattem Maul

with smooth jaws

BM024R



KILNER

BM018R

135 mm, 5 1/4"



BAUMGARTNER

BM015R

145 mm, 5 3/4"



Nadelhalter – Needle Holders
DUROGRIP® Nadelhalter
DUROGRIP® Needle Holders

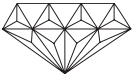

BM

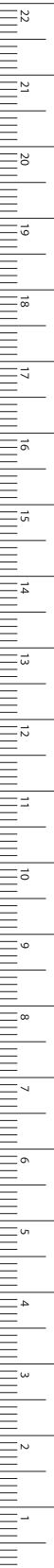

BABY-CRILE-WOOD
BM013R
 150 mm, 6"

BM016R	BM017R	BM019R	BM030R	BM021R
145 mm	185 mm	200 mm	270 mm	305 mm
5 3/4"	7 1/4"	8"	10 3/8"	12 1/2"

CRILE-WOOD
BM016R-BM030R

BM020R	BM023R
175 mm	260 mm
7"	10 1/4"

SAROT
BM020R-BM023R

HEGAR-MAYO-SEELEY
BM022R
 200 mm, 8"

Nadelhalter – Needle Holders

DUROGRIP® Nadelhalter

DUROGRIP® Needle Holders

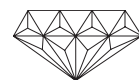

BM



HEGAR-MAYO

BM065R-BM070R

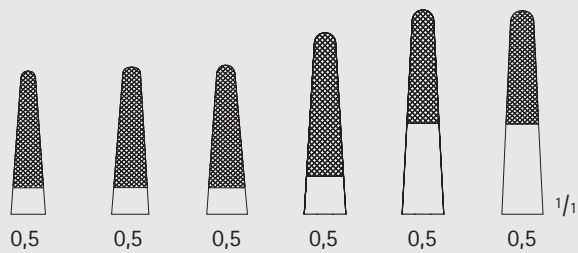

BM065R	BM066R	BM067R	BM068R	BM070R	BM069R
150 mm	185 mm	205 mm	235 mm	265 mm	300 mm
6"	7 1/4"	8"	9 1/4"	10 1/2"	12"

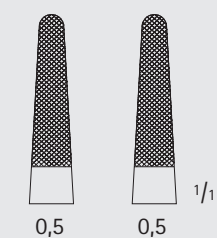

BM077R	BM078R
205 mm	245 mm
8"	9 3/4"

HEGAR

BM077R-BM078R

kräftige Modelle
heavy patterns

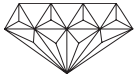

Nadelhalter – Needle Holders
 DUROGRIP® Nadelhalter mit Schere
 DUROGRIP® Needle Holders with Scissors

BM

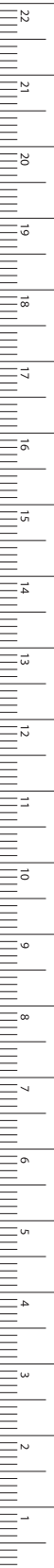

MILLIMETERS



BM127R

125 mm, 5"

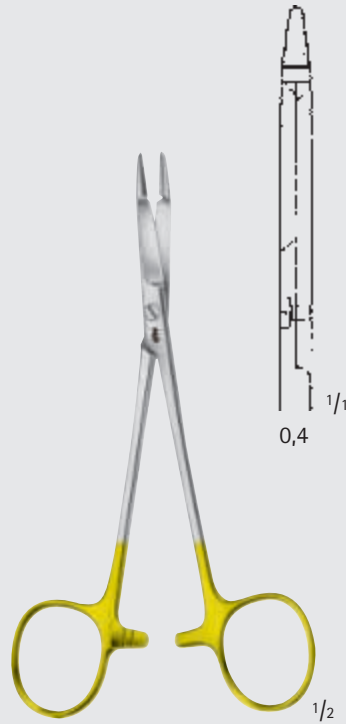

HEGAR-OLSEN MODIF. LANGE

BM128R

145 mm, 5 3/4"

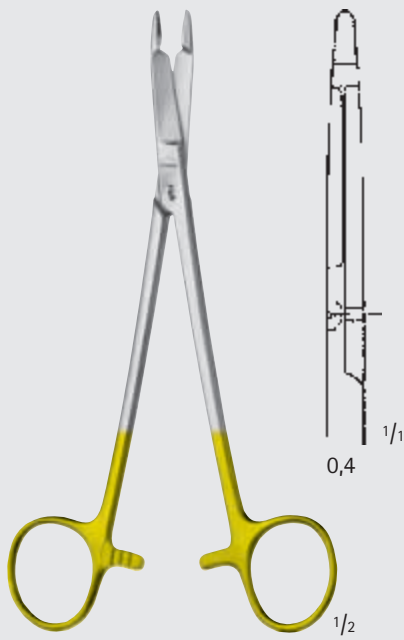

HEGAR-OLSEN

BM124R

1 Blatt fein gezahnt
1 blade fine serrated
165 mm, 6 1/2"

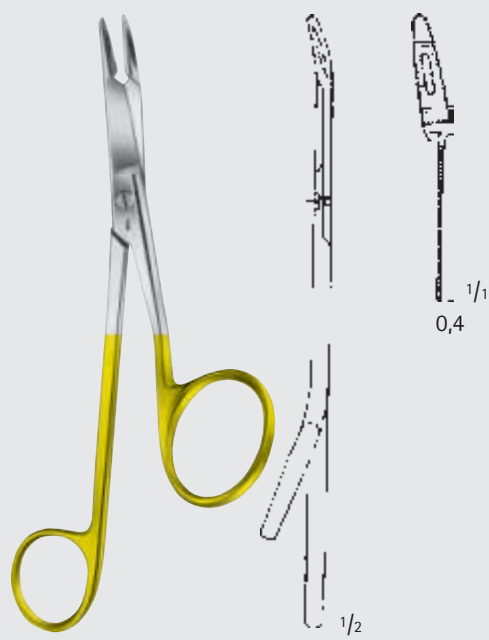

GILLIES

BM129R

160 mm, 6 1/4"

Nadelhalter – Needle Holders

DUROGRIP® Nadelhalter, Drahtspannzangen, Ligaturzangen

DUROGRIP® Needle Holders, Wire Twisters, Ligature Forceps

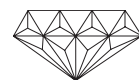

BM



BM110R

150 mm, 6"



BM111R

150 mm, 6"



BAUMGARTNER

BM112R

200 mm, 8"

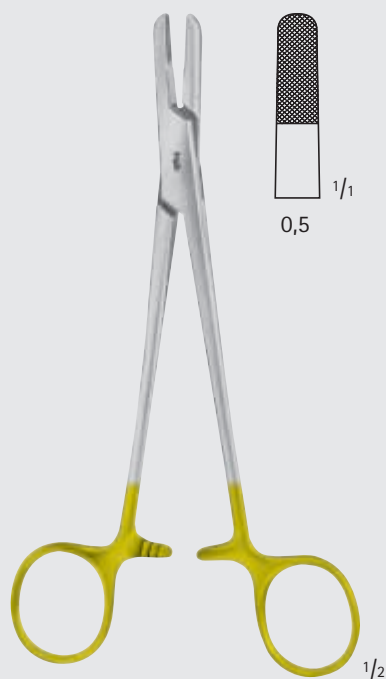

BM113R

175 mm, 7"



BERRY

MD456R

185 mm, 7 1/4"

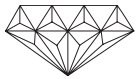

»grazil«

Nadelhalter – Needle Holders

DUROGRIP® Nadelhalter
DUROGRIP® Needle Holders

BM

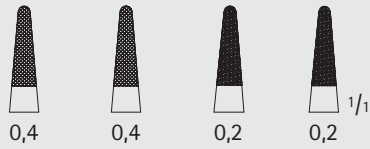

BM033R	BM034R	BM063R	BM064R
165 mm	210 mm	165 mm	210 mm
6 1/2"	8 1/4"	6 1/2"	8 1/4"

DE BAKLEY

BM033R-BM064R

sehr fein
very delicate

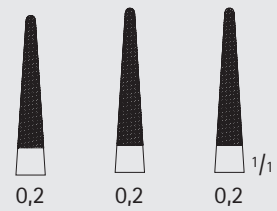

BM025R	BM026R	BM027R
180 mm	200 mm	230 mm
7"	8"	9"

BM025R-BM027R

sehr fein
very delicate

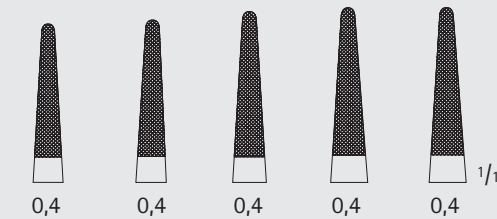

BM032R	BM035R	BM036R	BM037R	BM038R
150 mm	180 mm	230 mm	250 mm	305 mm
6"	7"	9"	10"	12"

DE BAKLEY

BM032R-BM038R

1/2



MILLIMETERS

Nadelhalter – Needle Holders

DUROGRIP® Nadelhalter

DUROGRIP® Needle Holders

»grazil«

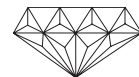

BM



DE BAKEY

BM040R

schlankes Modell
slender pattern

305 mm, 12"



DE BAKEY

BM051R-BM052R

Ringe griffgünstig abgesetzt
und gebogen
one extended handle and curved
rings ensure optimum grip

BM051R	BM052R
195 mm	245 mm
7 3/4"	9 3/4"



Nadelhalter – Needle Holders
DUROGRIP® Nadelhalter
DUROGRIP® Needle Holders

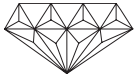

BM100R	BM101R	BM102R
200 mm	240 mm	300 mm
8"	9 1/2"	12"

WERTHEIM
BM100R-BM102R

BM095R	BM096R
210 mm	230 mm
8 1/4"	9"

STRATTE
BM095R-BM096R

BM081R	BM084R
200 mm	260 mm
8"	10 1/4"

HEANEY
BM081R-BM084R

BM082R
 S-förmig gebogen
 S-shaped
 215 mm, 8 1/2"

BM

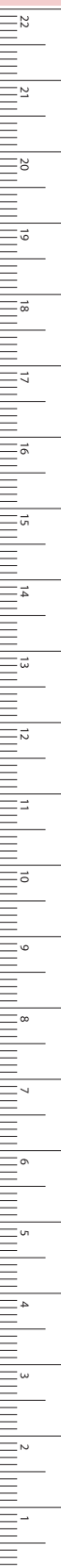

MILLIMETERS

Nadelhalter – Needle Holders

DUROGRIP® Nadelhalter

DUROGRIP® Needle Holders

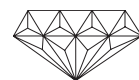

BM





Nadelhalter – Needle Holders
DUROGRIP® Nadelhalter
DUROGRIP® Needle Holders

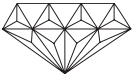

BM

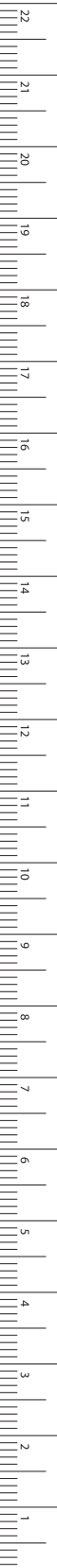

MILLIMETERS



NAUNTUN-MORGAN

BM088R

260 mm, 10 1/2"



MÜLLER

BM089R

für tiefe Rektumchirurgie
for deep rectum surgery
360 mm, 14"

Nadelhalter – Needle Holders

DUROGRIP® Nadelhalter

DUROGRIP® Needle Holders

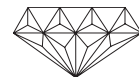

BM



MASSON

BM090R

265 mm, 10 1/2"



FINOCHIETTO

BM092R

265 mm, 10 1/2"



Nadelhalter – Needle Holders

DUROGRIP® Nadelhalter

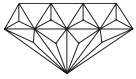

DUROGRIP® Needle Holders



Diese Spezialmodelle mit extra schmalen Mäulern eignen sich für atraumatische Nadeln und für feine Gefäßnadeln.

These special patterns with extremely fine jaws are suitable for holding non-traumatic needles and fine vein needles.

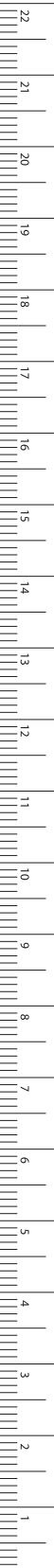
BM





BM074R	BM075R	BM076R
150 mm	180 mm	230 mm
6"	7"	9"

RYDER

BM074R-BM076R

mit glattem Maul
with smooth jaws





1/1
0,4

1/2

BM184R

200 mm, 8"

Nadelhalter – Needle Holders

DUROGRIP® Nadelhalter

DUROGRIP® Needle Holders

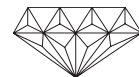

Diese Spezialmodelle mit extra schmalen Mäulern eignen sich für atraumatische Nadeln und für feine Gefäßnadeln.

These special patterns with extremely fine jaws are suitable for holding non-traumatic needles and fine vein needles.

»grazil«

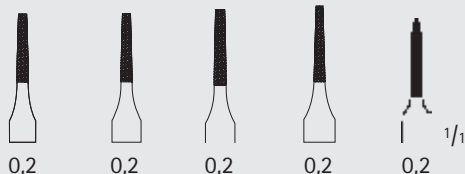

BM054R	BM055R	BM056R	BM057R	BM058R
135 mm	155 mm	175 mm	210 mm	230 mm
5 1/4"	6"	7"	8 1/4"	9"

RYDER

BM054R-BM058R

sehr fein

very delicate

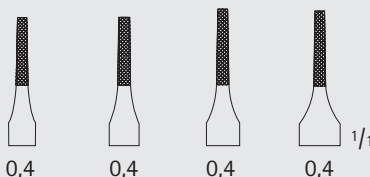

BM044R	BM045R	BM046R	BM047R
135 mm	175 mm	195 mm	265 mm
5 1/4"	7"	7 3/4"	10 1/2"

RYDER

BM044R-BM047R

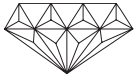

Nadelhalter – Needle Holders

DUROGRIP® Nadelhalter, ergonomische Griff-Form

DUROGRIP® Nadelhalter, Ergonomic Handle

Diese Instrumente bieten dem Chirurgen ein Maximum an ergonomischem Komfort. Das optimierte Design der Instrumente ermöglicht ein ermüdungsfreies Arbeiten insbesondere bei schwierigen Naht- und Anastomostechiken.

These instruments provide the surgeon with a maximum of ergonomic comfort. The optimized design of the Instruments offers a fatigue-free working especially with regard to difficult suture and anastomosis techniques.

BM

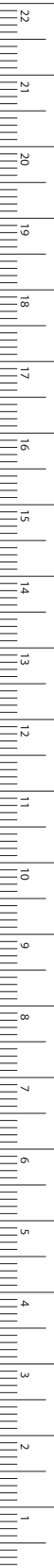

MILLIMETERS

HELLBERG-KUPKA
BM320R
mit Anreichsperre
with locking ratchet
210 mm, 8 1/4"

REIN-KUPKA
BM310R
ohne Sperre
without ratchet
190 mm, 7 1/2"

REIN-KUPKA
BM311R
mit Sperre
with ratchet
190 mm, 7 1/2"

Nadelhalter – Needle Holders

DUROGRIP® Nadelhalter

DUROGRIP® Needle Holders

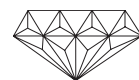

BM

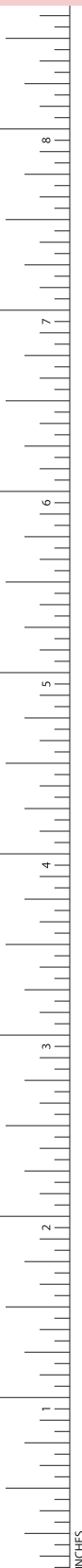

1/2

TÖNNIS

BM186R

elastisches Modell

elastic pattern

180 mm, 7"



1/2

TÖNNIS MODIF.

BM183R

elastisches Modell

elastic pattern

180 mm, 7"

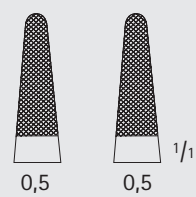

BM191R	BM193R
180 mm	200 mm
7"	8"

LANGENBECK

BM191R-BM193R



1/2

»grazil«

LANGENBECK

BM196R

200 mm, 8"



Nadelhalter – Needle Holders
 DUROGRIP® Nadelhalter
 DUROGRIP® Needle Holders

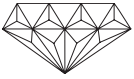

BM

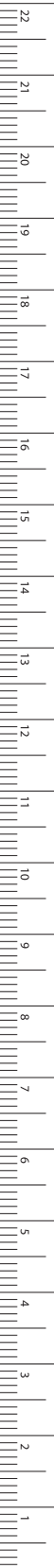

MILLIMETERS



ZWEIFEL

BM170R

200 mm, 8"



ZWEIFEL

BM172R

200 mm, 8"



AESCULAP

BM178R

200 mm, 8"

Nadelhalter – Needle Holders

DUROGRIP® Nadelhalter

DUROGRIP® Needle Holders

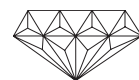

BM



»grazil«



LICHTENBERG

BM132R

elastisches Modell
elastic pattern

195 mm, 7 3/4"



BM165R

mit langem Hals
with long neck
205 mm, 8"



HÖSEL

BM168R

mit langem Hals
with long neck
260 mm, 10"



Nadelhalter – Needle Holders
 DUROGRIP® Nadelhalter
 DUROGRIP® Needle Holders

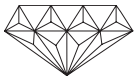

»grazil«

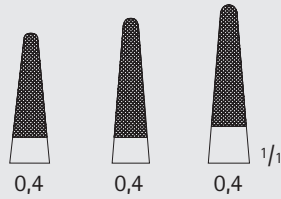

BM148R	BM150R	BM153R
140 mm	170 mm	200 mm
5 1/2"	6 3/4"	8"

MATHIEU

BM148R-BM153R

feine Modelle
 delicate patterns

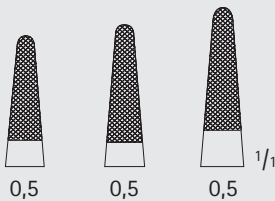

BM149R	BM151R	BM154R
140 mm	170 mm	200 mm
5 1/2"	6 3/4"	8"

MATHIEU

BM149R-BM154R

Standard-Modelle
 Standard patterns

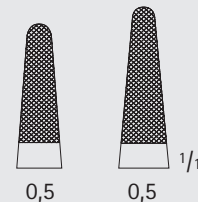

BM156R	BM158R
200 mm	245 mm
8"	9 3/4"

MATHIEU

BM156R-BM158R

kräftige Modelle
 heavy patterns

BM

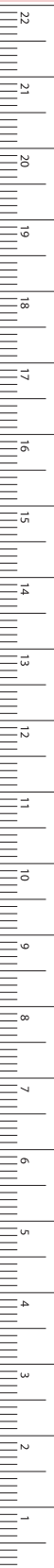

MILLIMETERS

Nadelhalter – Needle Holders

Bumerang-Nadelhalter

Boomerang Needle Holders

BM



BM627R



BM628R



BM629R

BM627R–BM629R

Ersatz-Nadeln

Spare needles



1/2

YOUNG-HRYNTSCHAK

BM620R

Bumerang-Nadelhalter
mit 1 Nadel BM627R
Boomerang Needle Holder
with 1 needle BM627R
240 mm, 9 1/2"



1/2

MILLIN

EF168R

Fadenhaltezange
Ligature holding forceps
285 mm, 9 3/4"



Nadelhalter – Needle Holders
Naht-Instrumente – Reverdin-Nadeln
Suture Instruments – Reverdin Needles

BM



BM711R

BM712R

BM713R

BM714R

REVERDIN

BM711R-BM714R

195 mm, 7 3/4"

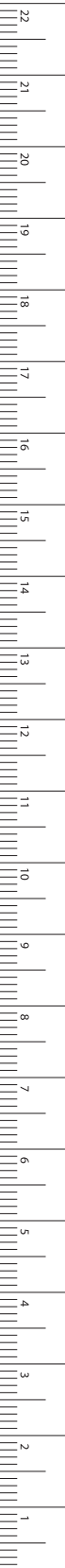

MILLIMETERS

Nadelhalter – Needle Holders
Naht-Instrumente - Reverdin-Nadeln
Suture Instruments - Reverdin Needles

BM

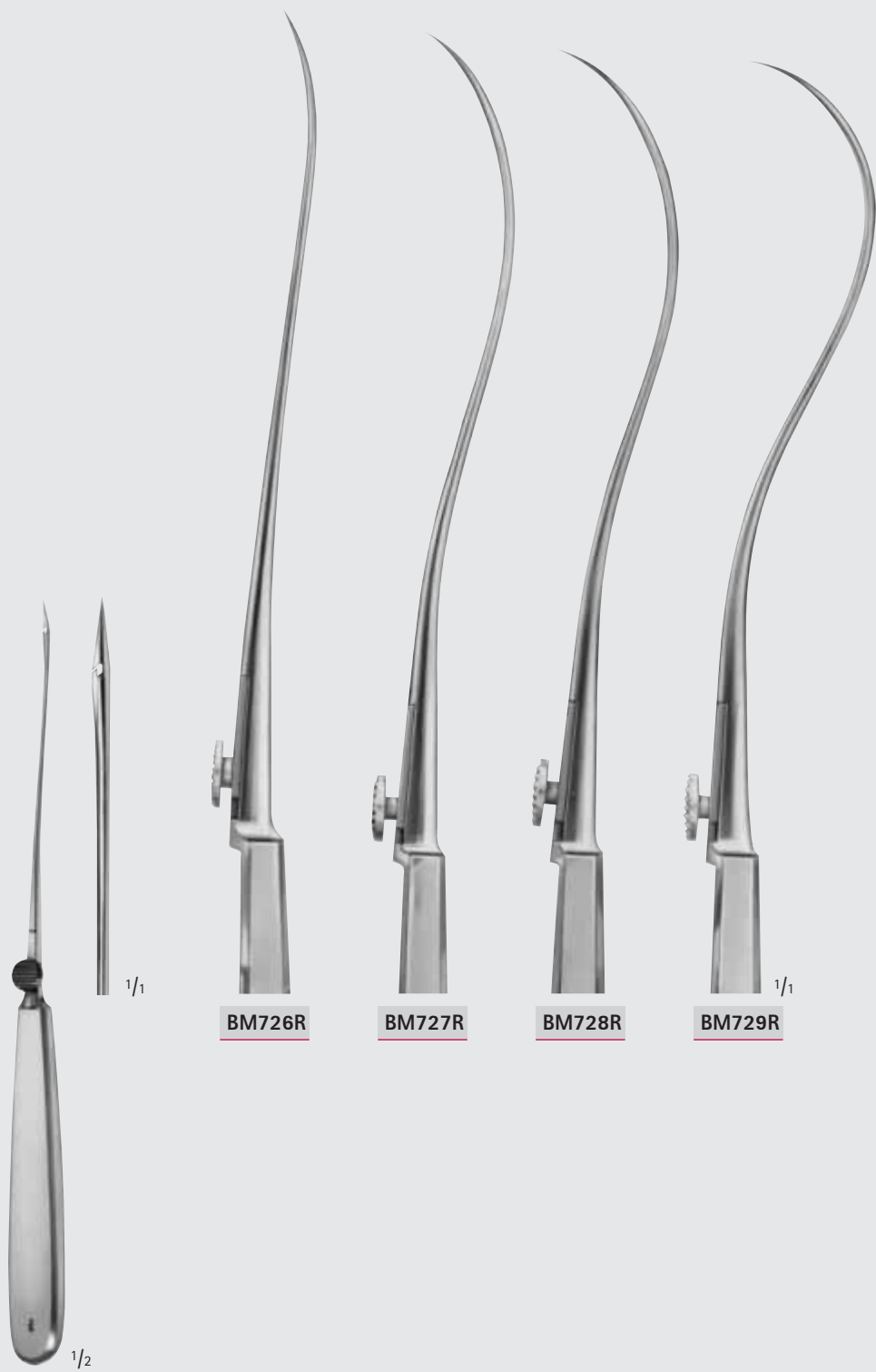

BM726R

BM727R

BM728R

BM729R

1/1

1/2

REVERDIN

BM726R-BM729R

220 mm, 8 3/4"



Nadelhalter – Needle Holders
 Naht-Instrumente - Unterbindungsnadeln
 Suture Instruments - Ligature Needles

BM

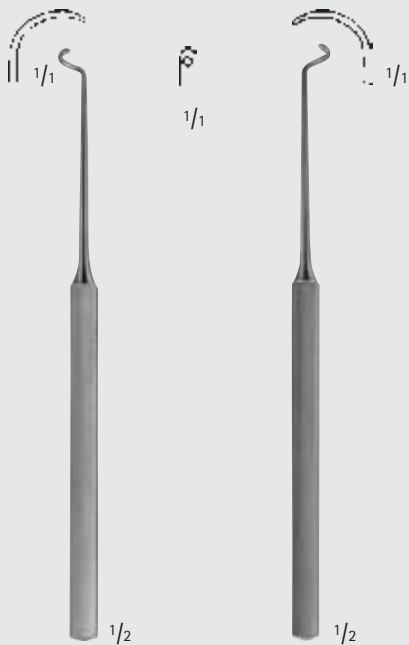
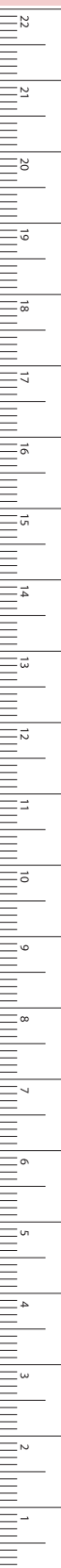

KRONECKER

BM801R

für rechte Hand
stumpf
for right hand
blunt
155 mm, 6"



KRONECKER

BM802R

für linke Hand
stumpf
for left hand
blunt
155 mm, 6"



DESCHAMPS

BM812R

für rechte Hand
steile Biegung
stumpf
for right hand
steep turn
blunt
225 mm, 9"



DESCHAMPS

BM813R

für linke Hand
steile Biegung
stumpf
for left hand
steep turn
blunt
225 mm, 9"



DESCHAMPS

BM814R

für rechte Hand
steile Biegung
stumpf
for right hand
steep turn
blunt
225 mm, 9"

MILLIMETERS

Nadelhalter – Needle Holders
 Naht-Instrumente - Unterbindungsnadeln
 Suture Instruments - Ligature Needles

BM



DESCHAMPS
BM806R
 für rechte Hand
 stumpf
 for right hand
 blunt
 215 mm, 8 1/2"



DESCHAMPS
BM807R
 für linke Hand
 stumpf
 for left hand
 blunt
 215 mm, 8 1/2"



DESCHAMPS
BM808R
 für rechte Hand
 stumpf
 for right hand
 blunt
 210 mm, 8 1/4"



DESCHAMPS
BM809R
 für linke Hand
 stumpf
 for left hand
 blunt
 210 mm, 8 1/4"



Nadelhalter – Needle Holders
 Naht-Instrumente - Unterbindungsnadeln
 Suture Instruments - Ligature Needles

BM

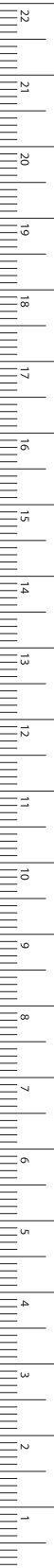

MILLIMETERS

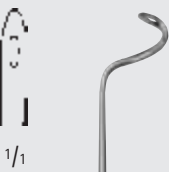
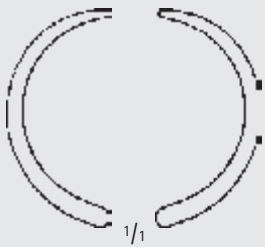

DESCHAMPS
BM810R
 für rechte Hand
 stumpf
 for right hand
 blunt
 215 mm, 8 1/2"

DESCHAMPS
BM811R
 für linke Hand
 stumpf
 for left hand
 blunt
 215 mm, 8 1/2"

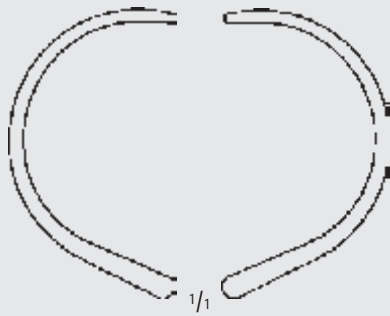

DESCHAMPS
BM822R
 für rechte Hand
 stumpf
 for right hand
 blunt
 240 mm, 9 1/2"

DESCHAMPS
BM823R
 für linke Hand
 stumpf
 for left hand
 blunt
 240 mm, 9 1/2"

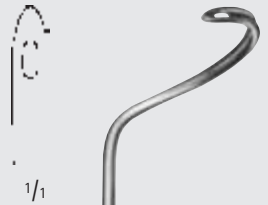
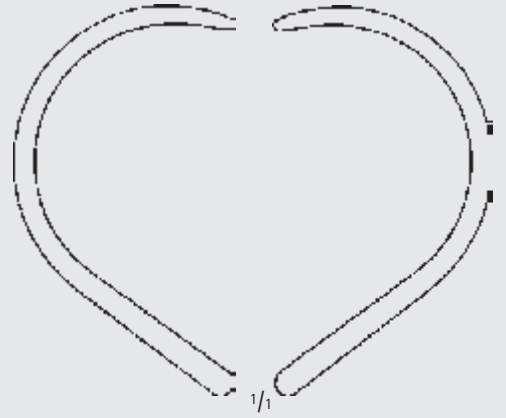

DESCHAMPS
BM824R
 für rechte Hand
 stumpf
 for right hand
 blunt
 280 mm, 11"

DESCHAMPS
BM825R
 für linke Hand
 stumpf
 for left hand
 blunt
 280 mm, 11"

Nadelhalter – Needle Holders
 Naht-Instrumente - Unterbindungsnadeln
 Suture Instruments - Ligature Needles

BM



HURD
BM770R
 für rechte Hand
 scharf
 for right hand
 sharp
 210 mm, 8 1/4"

HURD
BM771R
 für linke Hand
 scharf
 for left hand
 sharp
 210 mm, 8 1/4"



DESCHAMPS
BM780R
 für rechte Hand
 scharf
 for right hand
 sharp
 210 mm, 8 1/4"

DESCHAMPS
BM781R
 für linke Hand
 scharf
 for left hand
 sharp
 210 mm, 8 1/4"



Nadelhalter – Needle Holders
 Naht-Instrumente - Unterbindungsnadeln
 Suture Instruments - Ligature Needles

BM

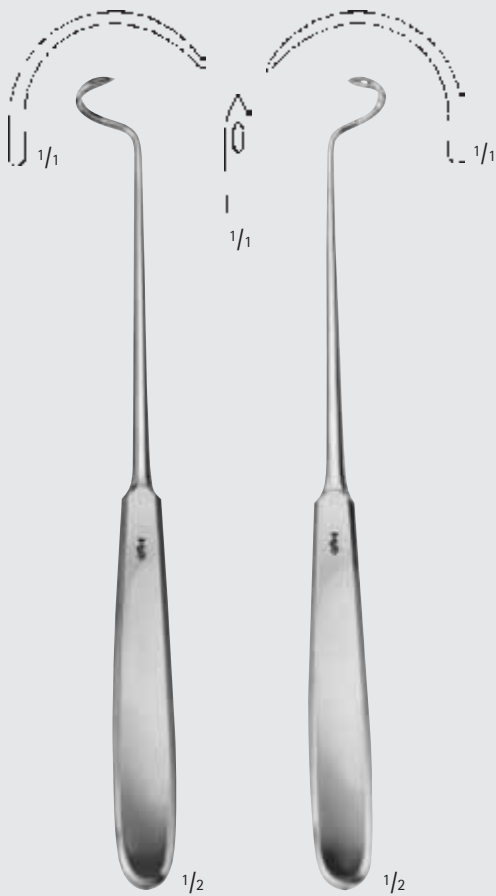

DESCHAMPS

BM748R

für rechte Hand
 scharf
 for right hand
 sharp
 215 mm, 8 1/2"

DESCHAMPS

BM749R

für linke Hand
 scharf
 for left hand
 sharp
 215 mm, 8 1/2"



JONESCO

BM755R

Hohlnadel
 Needle for wire suture
 185 mm, 7 1/4"



CLAUS VAN EICKEN

BM774R

250 mm, 10"

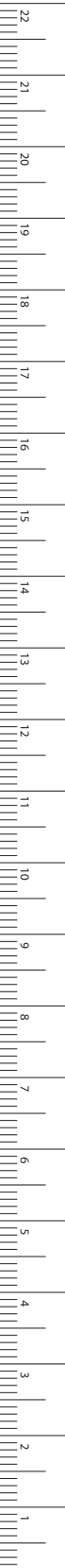

MILLIMETERS

Nadelhalter – Needle Holders

Unterbindungsnadeln

Ligature Needles

BM

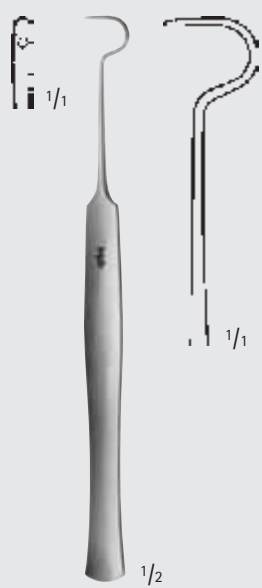

BM853R

150 mm, 6"



SYME

BM855R

170 mm, 6 3/4"

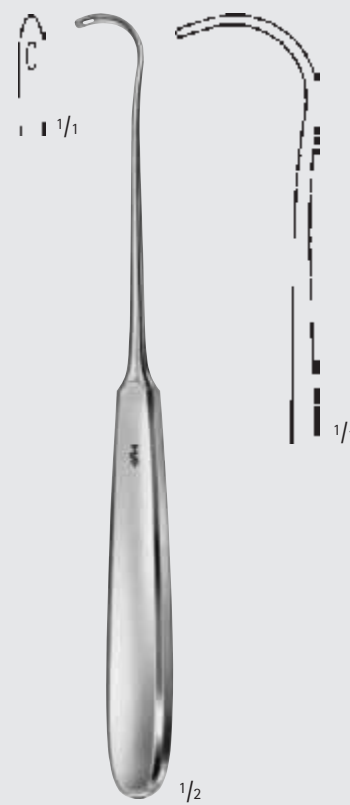

COOPER

BM856R

205 mm, 8"



Nadelhalter – Needle Holders
Unterbindungsnadeln
Ligature Needles

BM

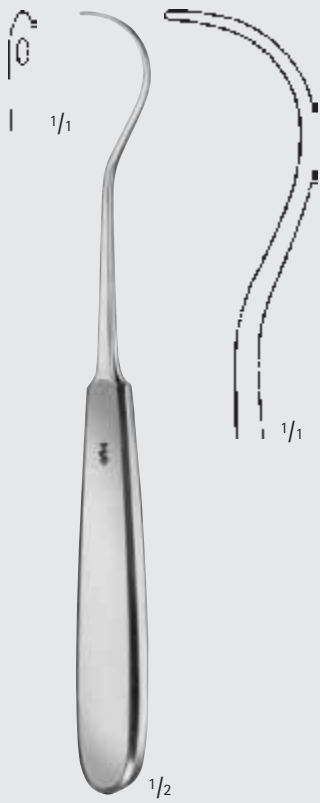

KOCHER

BM858R

205 mm, 8"

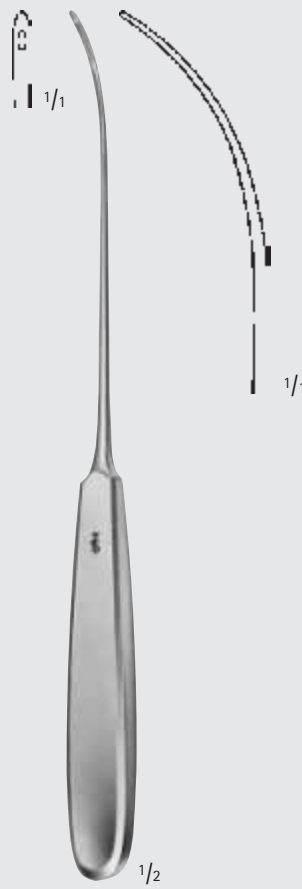

BM861R

biegsam
malleable
230 mm, 9"

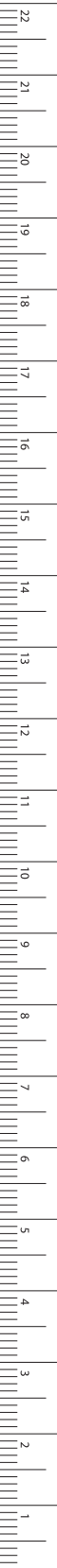

MILLIMETERS

Nadelhalter – Needle Holders

Unterbindungs-nadeln, Führungs-Hohlsonden nach BRUNNER

BRUNNER Ligature Needles, Guiding Probes

BM

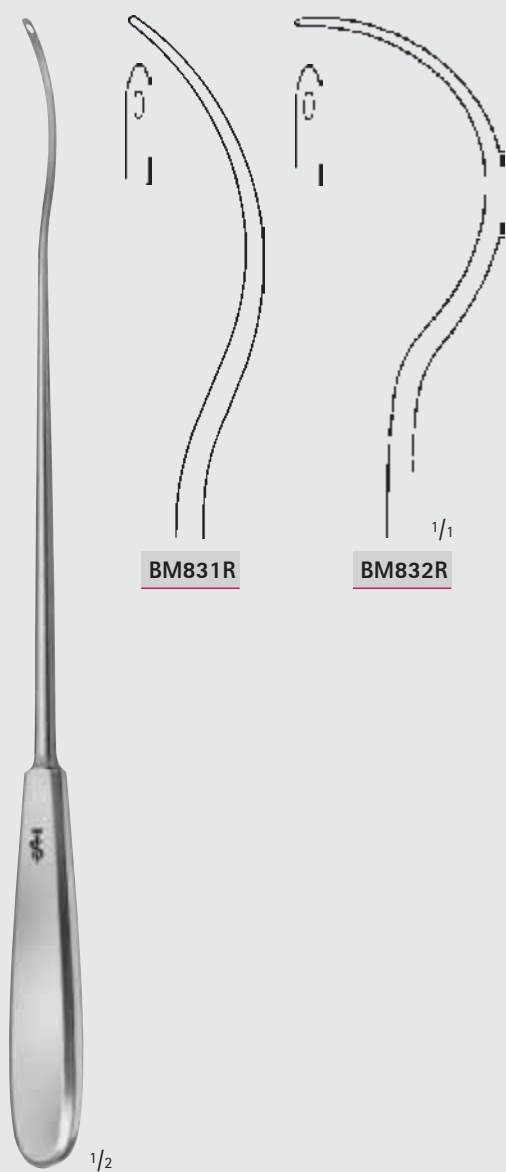

BM831R

BM832R

BRUNNER

BM831R-BM832R

Unterbindungs-nadeln

Ligature needles

300 mm, 12"

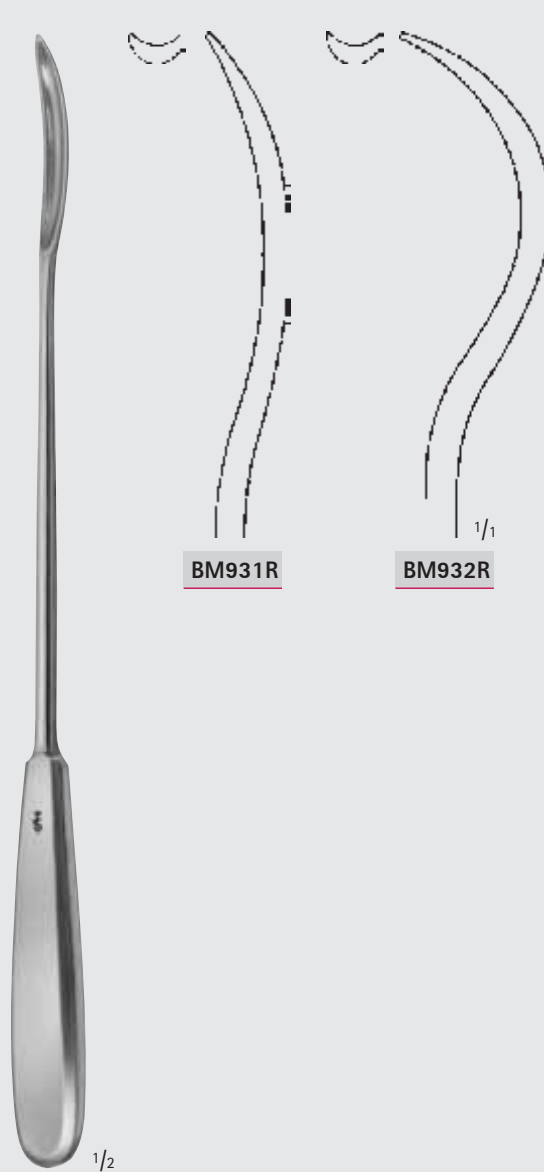

BM931R

BM932R

BRUNNER

BM931R-BM932R

Führungs-Hohlsonden

Guiding probes

300 mm, 12"



Nadelhalter – Needle Holders
 Führungs-Hohlsonden
 Guiding Probes

BM

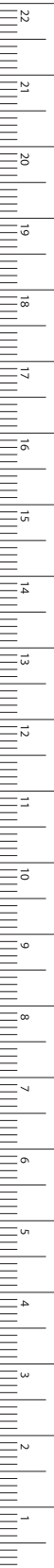

3 mm

1/2 1/1

BM900R
 200 mm, 8"

5 mm

1/2 1/1

KÖNIG
BM901R
 195 mm, 7 3/4"

7 mm

1/2 1/1

KÖNIG
BM902R
 200 mm, 8"

8 mm

1/2 1/1

SCHMIEDEN
BM905R
 185 mm, 7 1/4"

11 mm

1/2 1/1

KOCHER
BM911R
 150 mm, 6"

12 mm

1/2 1/1

KOCHER
BM913R
 170 mm, 6 3/4"

5 mm

1/2 1/1

PAYR
BM920R
 195 mm, 7 3/4"

5 mm

1/2 1/1

PAYR
BM922R
 225 mm, 9"

MILLIMETERS

Nadelhalter – Needle Holders

Führungs-Hohlsonden

Guiding Probes

Aus Kunststoff, zur Koagulation sterilisierbar im Autoklav bis 143 °C (3 bar)

Of plastic material, can be sterilized in an autoclave up to 143 °C (3 bar)

BM

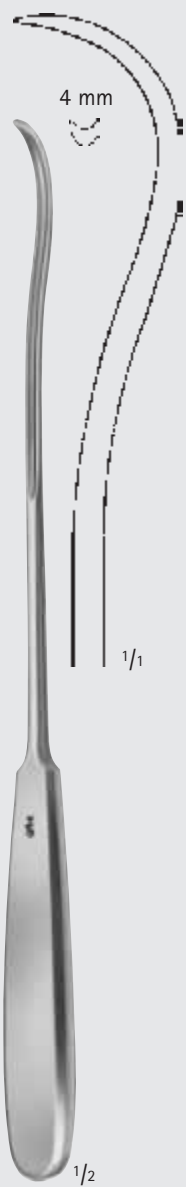

BM924R

280 mm, 11"

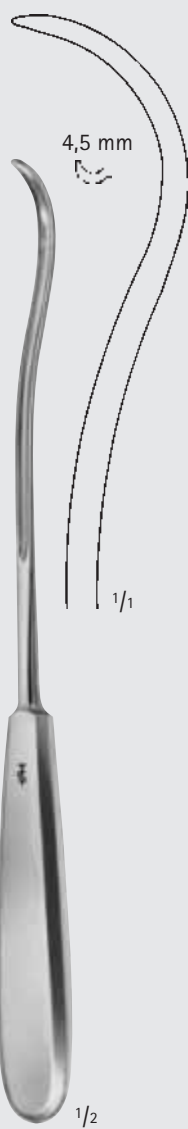

KIRSCHNER

BM925R

255 mm, 10"



BM938

240 mm, 9 1/2"

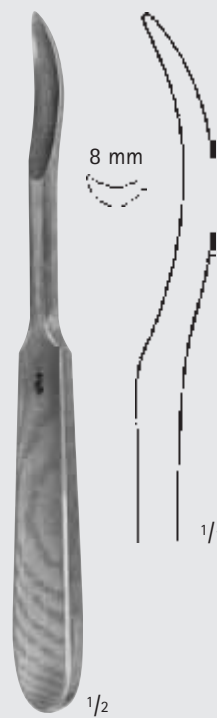

BM940

185 mm, 7 1/4"



BM941

265 mm, 10 1/2"



Nadelhalter – Needle Holders

Instrumente zur Naht
Suture Instruments

BM

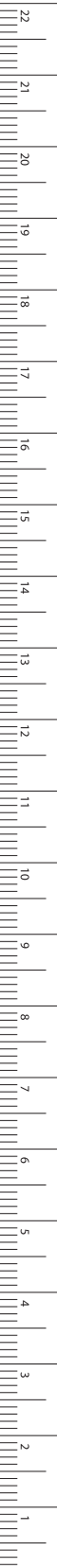

MILLIMETERS



BM950R

Fadengabel
Knot tier and Ligature adjuster
230 mm, 9"



CASPAR

FF309

Fadengabel
Knot tier and Ligature adjuster
230 mm, 9"

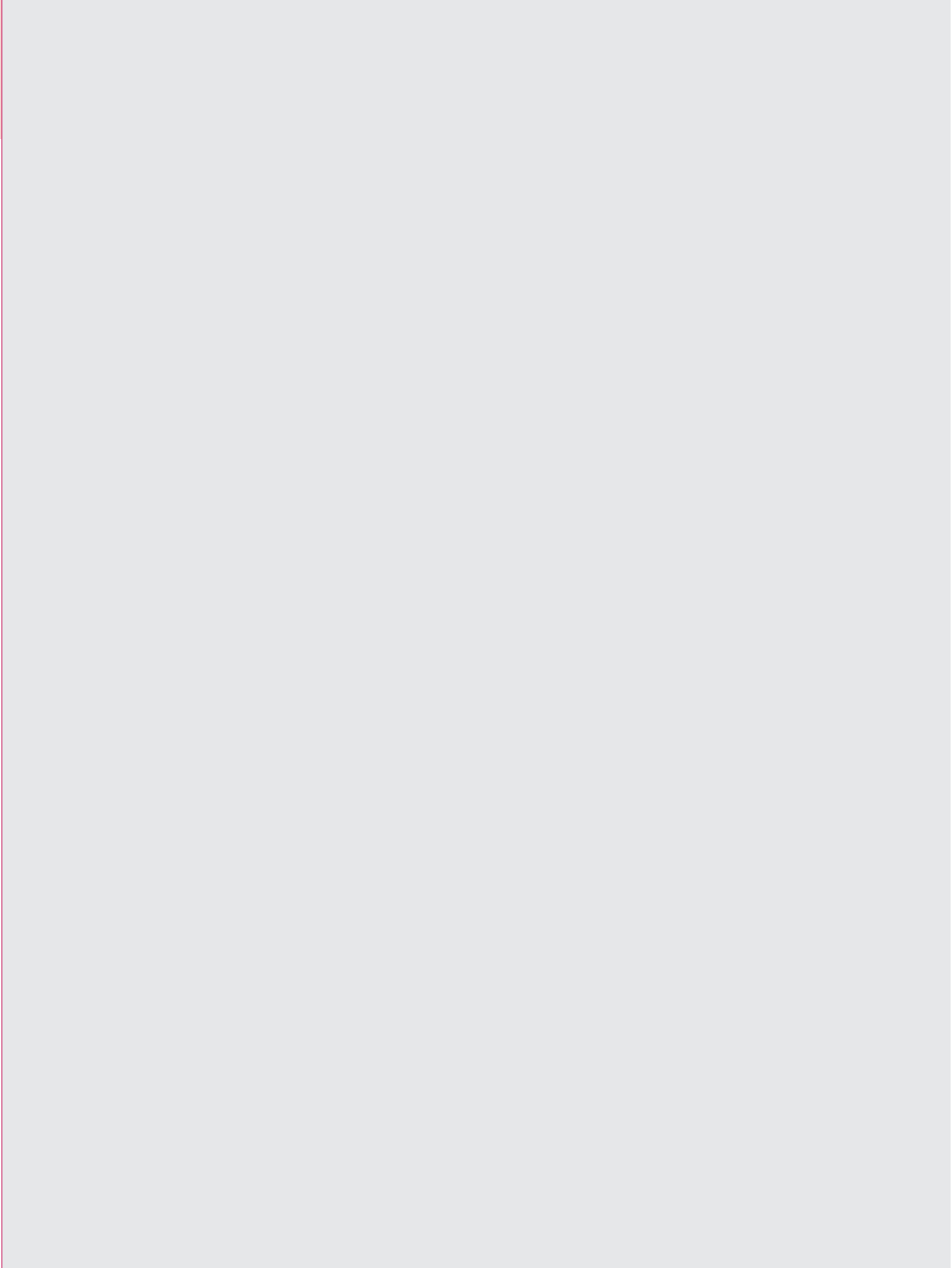



BN



Sonden, Watteträger, Wundklammern

Probes, Cotton Applicators, Suture Clips

Sonden – Probes

Sonden
Probes

BN

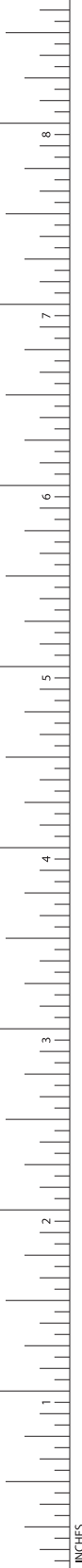

BN003R 130 mm, 5 1/8"
BN004R 145 mm, 5 3/4"
BN006R 160 mm, 6 1/4"
Hohlsonden
Directors

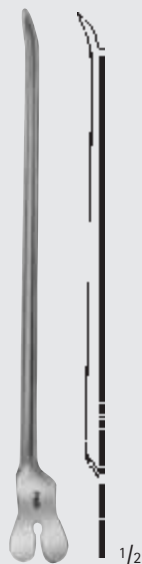

DOYEN
BN010R
Hohlsonde
Director
145 mm, 5 3/4"



NELATON
BN012R
Hohlsonde
Director
160 mm, 6 1/4"



Knopf-Ø 3,3 mm
Diam. of tip 3.3 mm
BN015R
Hohlsonde mit Knopf
Director with tip
140 mm, 5 1/2"

Knopf-Ø 3,5 mm
Diam. of tip 3.5 mm

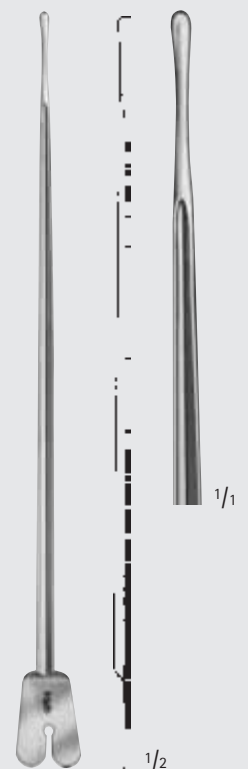

BRODIE
BN020R
Hohlsonde mit Knopf
Director with tip
200 mm, 8"



Sonden – Probes
Sonden
Probes

BN

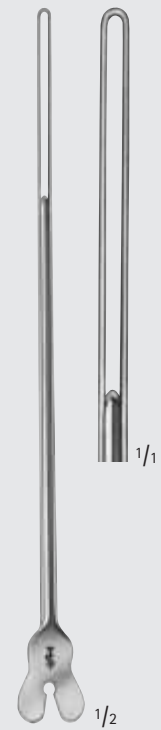
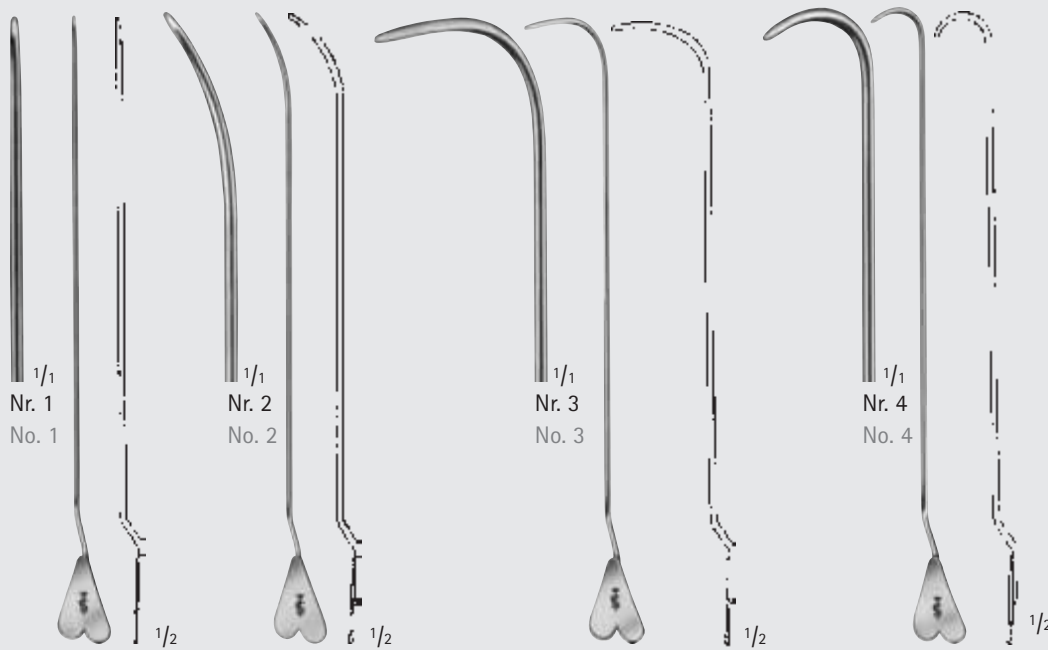

LOCKHART-MUMMERY

BN021R	Nr. 1 gerade	No. 1 straight
BN022R	Nr. 2 45° gebogen	No. 2 45° curved
BN023R	Nr. 3 90° gebogen	No. 3 90° curved
BN024R	Nr. 4 retrograd gebogen	No. 4 retrograde curved

Fistelsonden
Fistula probes
165 mm, 6 1/2"

BN026R
Ösenrinnensonde,
biegsam
Director with wire loop,
malleable
190 mm, 7 1/2"

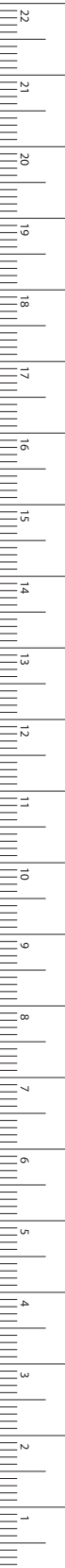

MILLIMETERS

Sonden – Probes

Sonden

Probes

BN



Knopf-Ø
Diam.
of tip

BN034R	145 mm, 5 3/4"	2,5 mm
BN036R	160 mm, 6 1/4"	2,5 mm
BN040R	200 mm, 8"	3,0 mm

BN034R-BN040R

Öhrsonden

Probes with eye



1/2

MB603R

125 mm, 5"

Knopf-Ø 1,5 mm
Diam. of tip 1.5 mm



1/2

BN054R

Myrtenblattsonde

Myrtle leaf probe

145 mm, 5 3/4"

Knopf-Ø 2,0 mm
Diam. of tip 2.0 mm

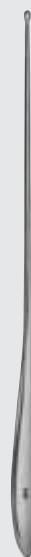

BN063R 130 mm, 5 1/8"

BN064R 145 mm, 5 3/4"

BN066R 160 mm, 6 1/4"

BN068R 180 mm, 7"

BN070R 200 mm, 8"

Myrtenblattsonden

Myrtle leaf probes



Sonden – Probes
Sonden
Probes

BN

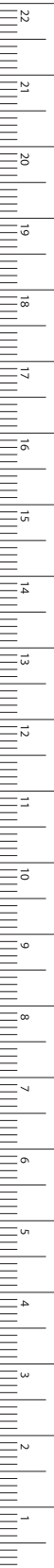

MILLIMETERS



Knopf-Ø Diam. of tip			Länge Length
1,0 mm	1,5 mm	2,0 mm	
	BN113R		130 mm, 5 1/8"
BN104R	BN114R	BN134R	145 mm, 5 3/4"
	BN116R	BN136R	160 mm, 6 1/4"
	BN118R	BN138R	180 mm, 7"
	BN120R	BN140R	200 mm, 8"
	BN125R		250 mm, 10"
		BN150R	300 mm, 12"

BN104R-BN150R

Knopfsonden
Probes

Knopf-Ø 1,2 mm
Diam. of tip 1.2 mm



1/2

BN110

Sinus-Knopfsonde
Sinus probe
150 mm, 6"

Knopf-Ø 3,0 mm
Diam. of tip 3.0 mm

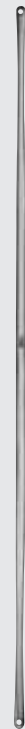

1/2

BN090R

Doppelknopfsonde,
biegsam, mit Loch
Double ended probe,
malleable, with hole
190 mm, 7 1/2"

Sonden – Probes

Sonden
Probes

BN



Knopf-Ø 3,5 mm
Diam. of tip 3.5 mm



BN095 250 mm, 10"

BN096 300 mm, 12"

Doppelknopfsonden,
Zinn, biegsam
Double ended probes,
tin, malleable

Knopf-Ø 4,0 mm
Diam. of tip 4.0 mm



1/2

BN099

Doppelknopfsonde,
Zinn, biegsam
Double ended probe,
tin, malleable
400 mm, 16"

Knopf-Ø 2,0 mm
Diam. of tip 2.0 mm



1/2

BN101R

Knopfsonde
Probe
300 mm, 12"



Sonden – Probes
Sonden
Probes

BN

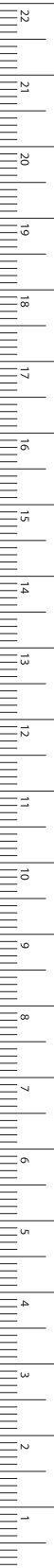

MILLIMETERS

Ø 0,8 mm
Diam. 0.8 mm



STACKE

BN160

Silber
silver
100 mm, 4"



CAWTHORNE

BN161

flaches Ende
Silber
flattened end
silver
140 mm, 5 1/2"

Ø 1,5 mm
Diam. 1.5 mm



KILLIAN

BN172R

165 mm, 6 1/2"

Ø 1,4 mm
Diam. 1.4 mm



BN170R

160 mm, 6 1/4"

Ø 1,0 mm
Diam. 1.0 mm



SEIFFERT

OM488

Silber
silver
195 mm, 7 3/4"



BOWMAN

OB510-OB514

Neusilber
German silver
130 mm, 5 1/8"

Ø
Diam.

OB510	0,7 + 0,8 mm	Fig. 00/0
OB511	0,9 + 1,1 mm	Fig. 1/2
OB512	1,3 + 1,4 mm	Fig. 3/4
OB513	1,5 + 1,6 mm	Fig. 5/6
OB514	1,8 + 1,9 mm	Fig. 7/8

Sonden – Probes
 Spatel – Watteträger
 Spatulas – Cotton Applicators

BN



1/2

BN184R

Spatel
 Spatula
 145 mm, 5 3/4"



16 mm

1/2

OM202R

Spatel
 Spatula
 145 mm, 5 3/4"

Ø 0,7 mm
 Diam. 0.7 mm



1/1

1/2

MODELL PICCOLO

OF261R

rund gerieft
 round serrated end
 110 mm, 4 1/2"

Ø 0,7 mm
 Diam. 0.7 mm

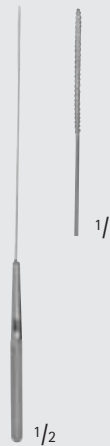

1/1

1/2

MODELL PICCOLO

OF262R

dreikant gerieft
 triangular serrated end
 110 mm, 4 1/2"

Ø 1,2 mm
 Diam. 1.2 mm

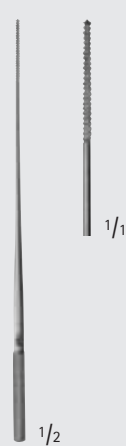

1/1

1/2

FARRELL

OF257R

rund gerieft
 round serrated end
 110 mm, 4 1/2"

Ø 1,4 mm
 Diam. 1.4 mm



1/1

1/2

LATHBURY-FARRELL

OF259R

dreikant gerieft
 triangular serrated end
 110 mm, 4 1/2"



Sonden – Probes
Watteträger
Cotton Applicators

BN

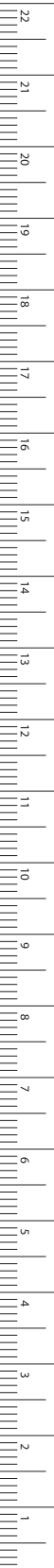

MILLIMETERS

Ø 0,9 mm
Diam. 0.9 mm

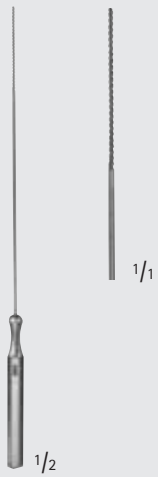

BUCK

BN400R

spiralförmig gerieft
rough, spiral end
120 mm, 4 3/4"

Ø 0,9 mm
Diam. 0.9 mm

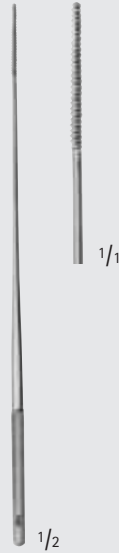

LATHBURY-FARRELL

BN467R

dreikant gerieft
triangular serrated end
140 mm, 5 1/2"



KINGS'S COLLEGE HOSPITAL

BN403

spiralförmig gerieft
rough, spiral end
90 mm, 3 3/8"



KINGS'S COLLEGE HOSPITAL

BN404

spiralförmig gerieft
rough, spiral end
135 mm, 5 1/8"

Ø 1,0 mm
Diam. 1.0 mm



BN440R

spiralförmig gerieft
rough, spiral end
140 mm, 5 1/2"

Ø 1,2 mm
Diam. 1.2 mm



BN445R

spiralförmig gerieft
rough, spiral end
140 mm, 5 1/2"

Sonden – Probes
 Watteträger
 Cotton Applicators

BN



Ø 1,2 mm
 Diam. 1.2 mm



FARRELL

BN460R

rund gerieft
 round serrated end
 140 mm, 5 1/2"

Ø 1,4 mm
 Diam. 1.4 mm

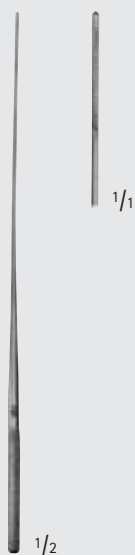

LATHBURY-FARRELL

BN465R

dreikant gerieft
 triangular serrated end
 140 mm, 5 1/2"

Ø 1,2 mm
 Diam. 1.2 mm

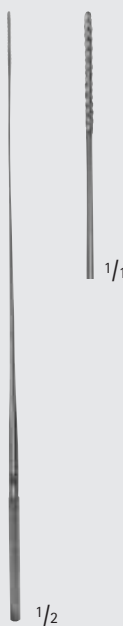

FARRELL

BN461R

spiralförmig gerieft
 rough, spiral end
 160 mm, 6 1/4"

Ø 1,2 mm
 Diam. 1.2 mm



LATHBURY-FARRELL

BN466R

dreikant gerieft
 triangular serrated end
 160 mm, 6 1/4"

Ø 1,4 mm
 Diam. 1.4 mm

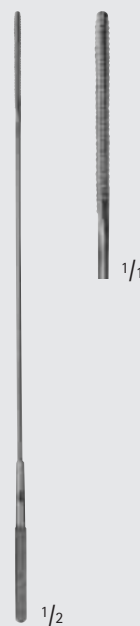

LATHBURY-FARRELL

BN468R

dreikant gerieft
 triangular serrated end
 160 mm, 6 1/4"



Sonden – Probes
Watteträger
Cotton Applicators

BN

Ø 1,5 mm
Diam. 1.5 mm

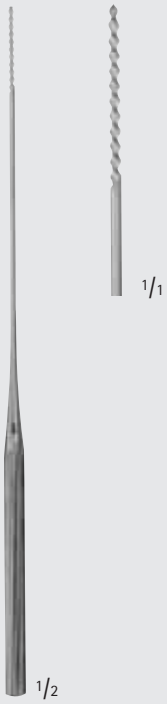

BN452R

spiralförmig gerieft
rough, spiral end
180 mm, 7"

Ø 1,8 mm
Diam. 1.8 mm



BN457R

spiralförmig gerieft
rough, spiral end
180 mm, 7"

Ø 2,3 mm
Diam. 2.3 mm

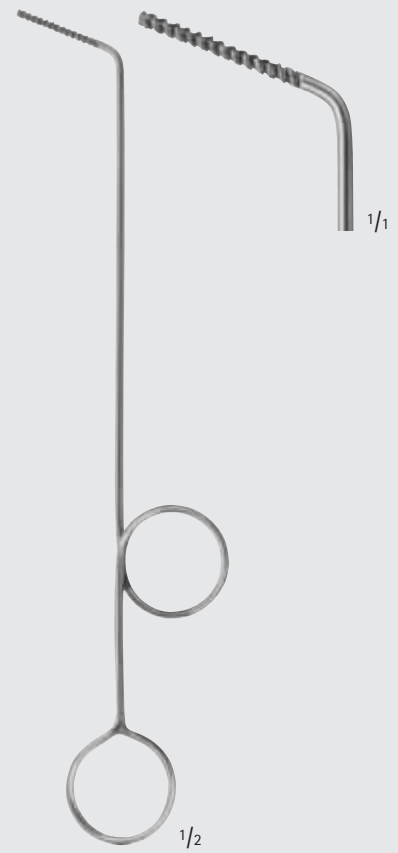

HARTMANN

OM487R

spiralförmig gerieft
rough, spiral end
220 mm, 8 1/2"

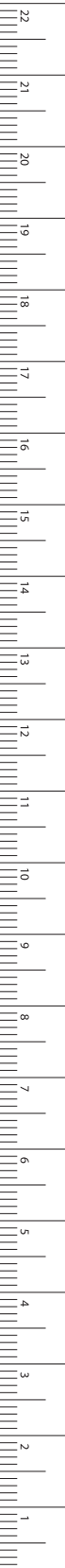

MILLIMETERS

Sonden – Probes

Wundklammern – Klammeranlegepinzetten – Klammeranlege- und Entfernungszangen
Suture Clips – Clip Applying Forceps – Clip Applying- and Removing Forceps

BN

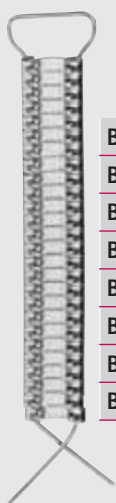

Größe mm
Sizes mm

BN507R	7,5 x 1,75
BN511R	11,0 x 2,0
BN512R	12,0 x 2,5
BN515R	14,0 x 3,0
BN516R	16,0 x 3,0
BN518R	18,0 x 3,0
BN520R	20,0 x 3,0
BN522R	22,0 x 3,0



1/1



1/1

MICHEL

BN507R-BN522R

Wundklammern aus nichtrostendem Stahl
Bestelleinheit: **PAK** = 1 Packung à 100 Stück
Suture clips, stainless steel
Sales unit: **PAK** = 1 Package of 100 pieces



1/2

MICHEL

BN730R

Klammeranlegepinzette
Clip applying forceps
125 mm, 5"



1/2

HEGENBARTH

BN731R

Klammeranlegepinzette
Clip applying forceps
120 mm, 4 3/4"



1/2

MICHEL

BN750R

Klammeranlege und
-Abnehmzange
Clip applying and
removing forceps
125 mm, 5"



1/2

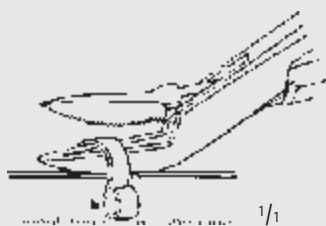

1/1

MICHEL MODIF.

BN754R

Klammeranlege und -Abnehmzange
Clip applying and removing forceps
130 mm, 5 1/8"



1/2

HEATH

BN757R

Klammerabnehmzange
Clip removing forceps
135 mm, 5 1/4"



1/2

COLLIN

BN758R

Klammerabnehmzange
Clip removing forceps
135 mm, 5 1/4"



Sonden – Probes
 REDON-Führungsnadeln
 REDON-Guide Needles

BN



Charr.

- 8 **BN902R**
- 10 **BN903R**
- 12 **BN904R**
- 14 **BN905R**
- 16 **BN906R**
- 18 **BN907R**

mit Gewindeanschluss
 Messerspitze,
 schwach gebogen
 with thread
 knife tip, slightly curved
 190 mm, 7 1/2"

- BN912R**
- BN913R**
- BN914R**
- BN915R**
- BN916R**
- BN917R**

mit Gewindeanschluss
 Messerspitze,
 stark gebogen
 with thread
 knife tip, strongly curved
 190 mm, 7 1/2"

- BN922R**
- BN923R**
- BN924R**
- BN925R**
- BN926R**

mit Gewindeanschluss
 Lanzettenspitze,
 schwach gebogen
 with thread
 lancet tip, slightly curved
 190 mm, 7 1/2"

- BN942R**
- BN943R**
- BN944R**
- BN945R**
- BN946R**
- BN947R**

mit Gewindeanschluss
 Dreikantspitze,
 schwach gebogen
 with thread
 trocar tip, slightly curved
 190 mm, 7 1/2"

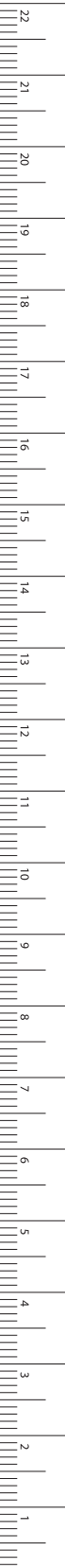

MILLIMETERS



INCHES



BT



Wundhaken

Wound Retractors

Wundhaken – Wound Retractors

Nerv- und Gefäßhäkchen

Nerve- and Vessel Hooks

BT

Maßangaben für Blattgrößen der Wundhaken

1. Zahl = Tiefe Beispiel: 25 x 38 mm

2. Zahl = Breite

Dimensions for blade size of retractors

1st number = depth Example: 25 x 38 mm

2nd number = width

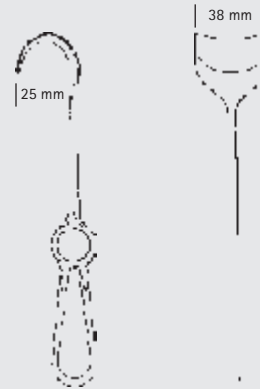

OF282R OF283R OF284R OF285R 1/1

WAGENER

OF282R-OF285R

150 mm, 6"

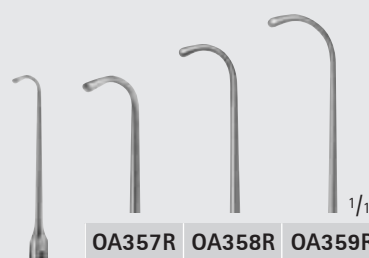

OA357R OA358R OA359R 1/1

GRAEFE

OA357R-OA359R

140 mm, 5 1/2"



1/1

ST. BARTS

OF288R

Ohrhäkchen, stumpf

Hook, blunt

180 mm, 7"



Wundhaken – Wound Retractors

Nerv- und Gefäßhäkchen
Nerve- and Vessel Hooks

BT

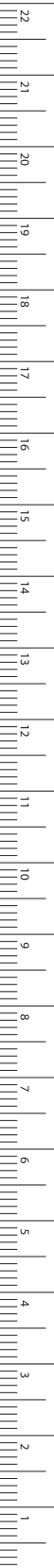

MILLIMETERS



BROM

BT075R

Venenhäkchen
Vein hook
170 mm, 6 3/4"



CRILE

BT080R

200 mm, 8"



CUSHING

BT082R–BT083R

190 mm, 7 1/2"

Wundhaken – Wound Retractors

Nerv- und Gefäßhäkchen

Nerve- and Vessel Hooks

Maßangaben für Blattgrößen der Wundhaken

1. Zahl = Tiefe Beispiel: 25 x 38 mm

2. Zahl = Breite

Dimensions for blade size of retractors

1st number = depth Example: 25 x 38 mm

2nd number = width

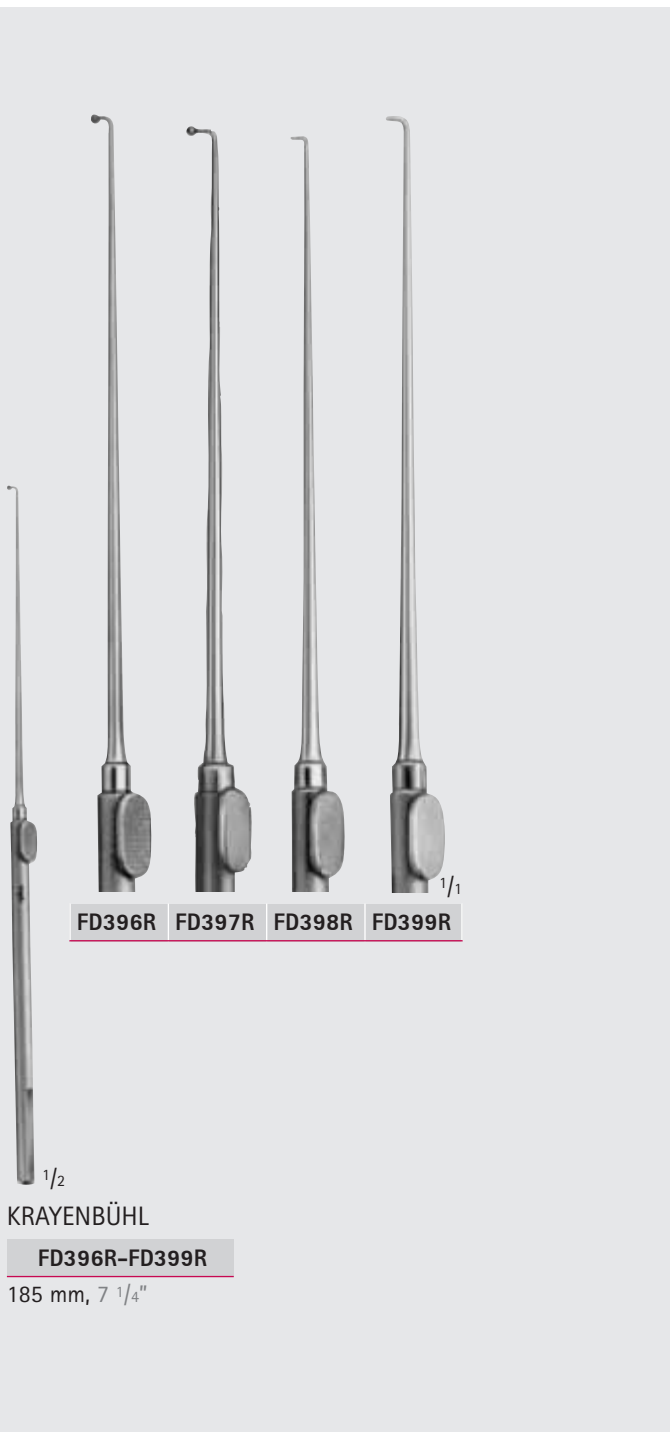
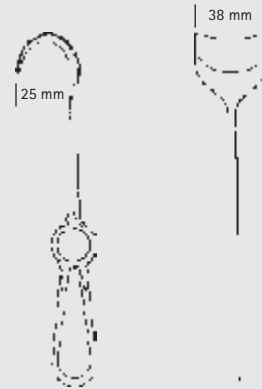

BT





Wundhaken – Wound Retractors

Nerv- und Gefäßhäkchen
Nerve- and Vessel Hooks

BT

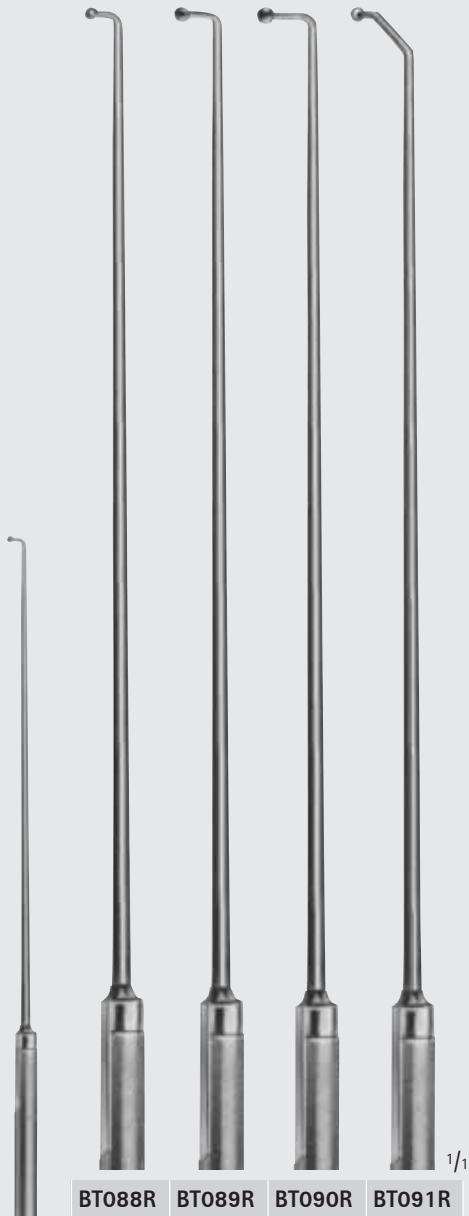

BT088R BT089R BT090R BT091R

CASPAR

BT088R-BT091R

Explorationshäkchen,
geknöpft
Exploration hooks,
probe-ended
245 mm, 9 3/4"

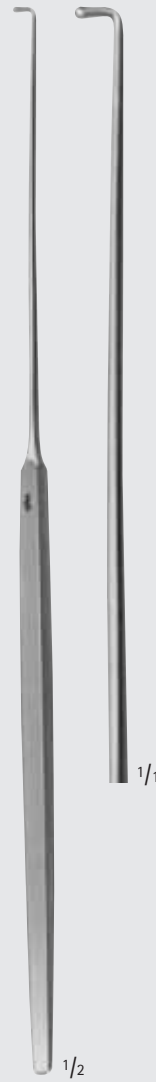

CUSHING

BT084R

280 mm, 11"

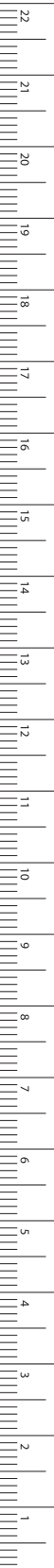

MILLIMETERS

Wundhaken – Wound Retractors

Feine Wundhäkchen (Dura- und Hauthäkchen)

Fine Wound Retractors (Dura- and Skin Retractors)

Maßangaben für Blattgrößen der Wundhaken

1. Zahl = Tiefe Beispiel: 25 x 38 mm

2. Zahl = Breite

Dimensions for blade size of retractors

1st number = depth Example: 25 x 38 mm

2nd number = width

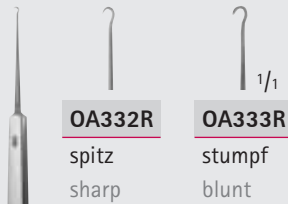
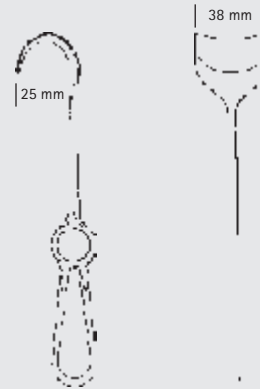

OA332R

spitz
sharp

OA333R

stumpf
blunt

GRAEFE

OA332R-OA333R

125 mm, 5"

1/2

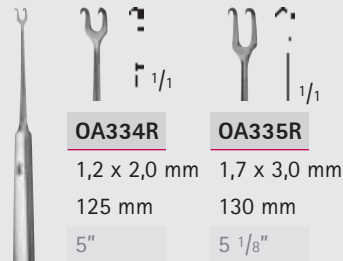

OA334R

1,2 x 2,0 mm

125 mm

5"

OA335R

1,7 x 3,0 mm

130 mm

5 1/8"

GUTHRIE

OA334R-OA335R

spitz
sharp

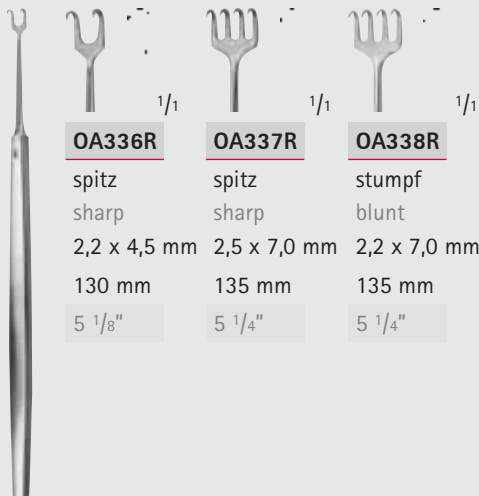

OA336R

spitz
sharp

2,2 x 4,5 mm

130 mm

5 1/8"

OA337R

spitz
sharp

2,5 x 7,0 mm

135 mm

5 1/4"

OA338R

stumpf
blunt

2,2 x 7,0 mm

135 mm

5 1/4"

ROLLET

OA336R-OA338R



CAIRNS

FF313R

Durahäkchen
Dura retractor
130 mm, 5 1/8"



FRAZIER

FF321R

Durahäkchen
Dura retractor
130 mm, 5 1/8"



TÖNNIS

FF322R

Durahäkchen
Dura retractor
150 mm, 6"



Wundhaken – Wound Retractors

Feine Wundhäkchen (Dura- und Hauthäkchen)
Fine Wound Retractors (Dura- and Skin Retractors)

BT



1/2

KILNER

OL610R

160 mm, 6 1/4"



1/2

MC INDOE

OL615R-OL616R

150 mm, 6"



1/2

FREER

OL621R

150 mm, 6"



1/2

MÜLLER

OL626R

150 mm, 6"



1/2

MÜLLER

OL627R

150 mm, 6"



1/2

COTTLE

OL617R

160 mm, 6 1/4"



1/2

COTTLE

OL619R

160 mm, 6 1/4"

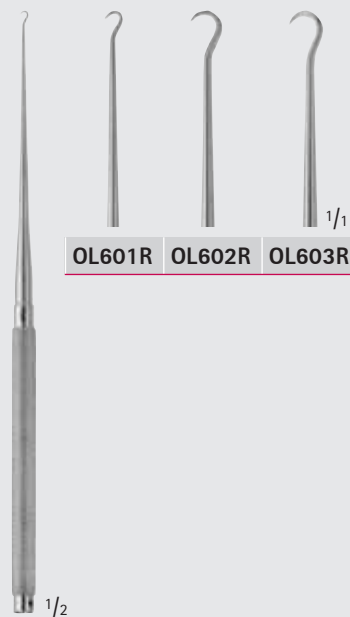

1/2

KLEINERT-KUTZ

OL601R-OL603R

160 mm, 6 3/8"

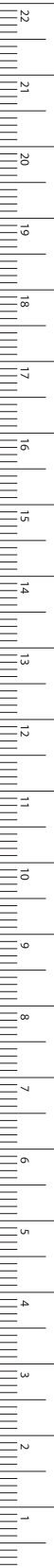

MILLIMETERS

Wundhaken – Wound Retractors

Feine Wundhäkchen (Dura- und Hauthäkchen)

Fine Wound Retractors (Dura- and Skin Retractors)

Maßangaben für Blattgrößen der Wundhaken

1. Zahl = Tiefe Beispiel: 25 x 38 mm

2. Zahl = Breite

Dimensions for blade size of retractors

1st number = depth Example: 25 x 38 mm

2nd number = width

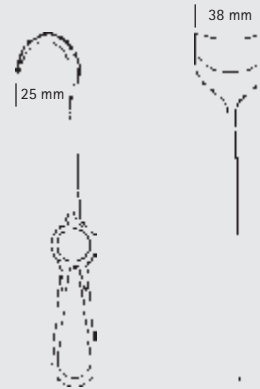

BT



JÄGER

OA351R

135 mm, 5 1/4"

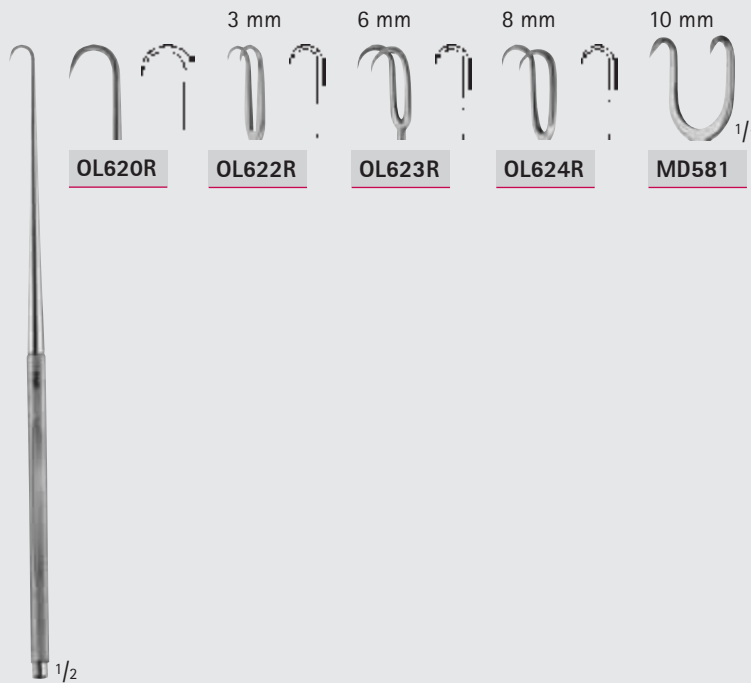

JOSEPH

OL620R-MD581R

165 mm, 6 1/2"



GILLIES

OL611R-OL612R

180 mm, 7"

Wundhaken – Wound Retractors

Feine Wundhäkchen (Dura- und Hauthäkchen)
Fine Wound Retractors (Dura- and Skin Retractors)

BT

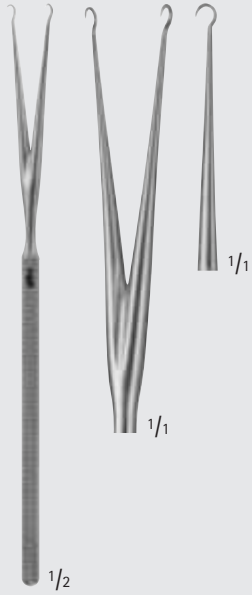

BARSKY

OL614R

155 mm, 6"



DURAHÄKCHEN

FD375R

Dura retractor
185 mm, 7 1/4"



FISCH

FD376R

Dura retractor
185 mm, 7 1/4"



KILNER

OL206R

spitz
sharp
80 mm, 3 1/4"

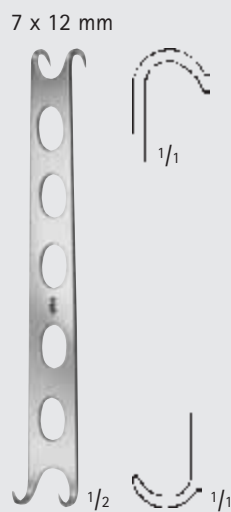

CONVERSE

OL207R

stumpf
blunt
120 mm, 4 3/4"

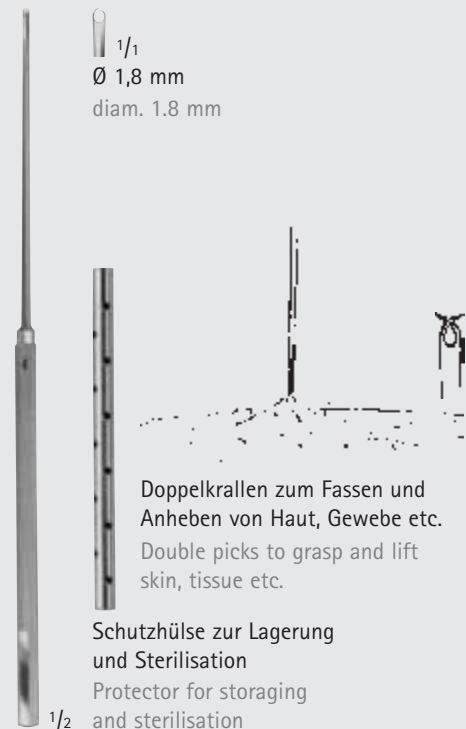

GEWEBEKRALLE

FD392R

Tissue pick
185 mm, 7 1/4"

Doppelkrallen zum Fassen und Anheben von Haut, Gewebe etc.
Double picks to grasp and lift skin, tissue etc.

Schutzhülse zur Lagerung und Sterilisation
Protector for storing and sterilisation



MILLIMETERS

Wundhaken – Wound Retractors

Wund- und Trachealhäkchen

Wound- and Trachea Retractors

BT

Maßangaben für Blattgrößen der Wundhaken

1. Zahl = Tiefe Beispiel: 25 x 38 mm

2. Zahl = Breite

Dimensions for blade size of retractors

1st number = depth Example: 25 x 38 mm

2nd number = width

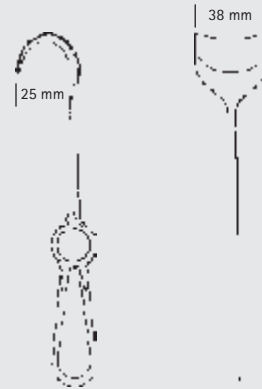

BERGMANN

BT100R

140 mm, 5 1/2"



BOSE

FA025R

165 mm, 6 1/2"



BOSE

FA026R

165 mm, 6 1/2"

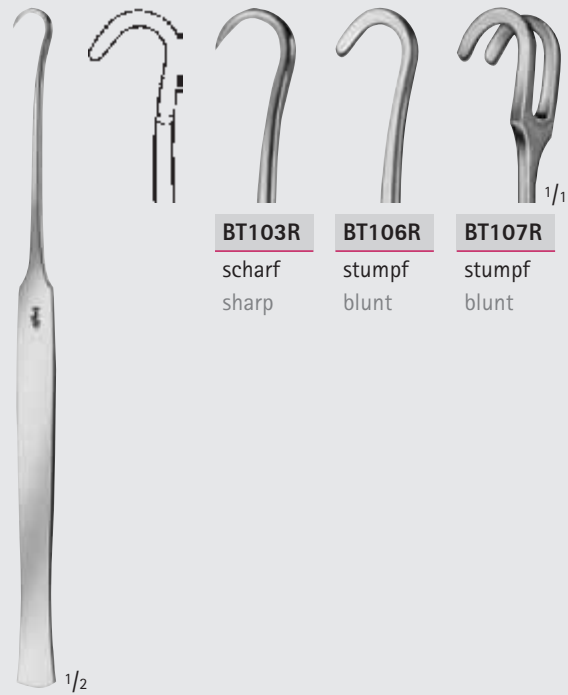

BT103R

scharf
sharp

BT106R

stumpf
blunt

BT107R

stumpf
blunt

BT103R-BT107R

180 mm, 7"



Wundhaken – Wound Retractors

Wund- und Trachealhäkchen
Wound- and Trachea Retractors

BT

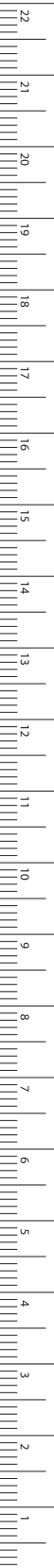

MILLIMETERS



BT132R-BT134R
flexibler Schaft, scharf
flexible shaft, sharp
155 mm, 6"



BT136R-BT138R
flexibler Schaft, stumpf
flexible shaft, blunt
155 mm, 6"



BT111R-BT114R
enge Biegung, scharf
small curve, sharp
165 mm, 6 1/2"

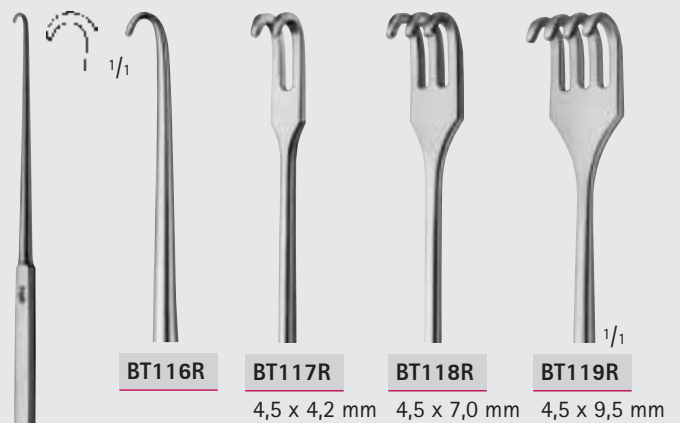

BT116R-BT119R
enge Biegung, stumpf
small curve, blunt
165 mm, 6 1/2"

Wundhaken – Wound Retractors

Wund- und Trachealhäkchen

Wound- and Trachea Retractors

Maßangaben für Blattgrößen der Wundhaken

1. Zahl = Tiefe Beispiel: 25 x 38 mm

2. Zahl = Breite

Dimensions for blade size of retractors

1st number = depth Example: 25 x 38 mm

2nd number = width

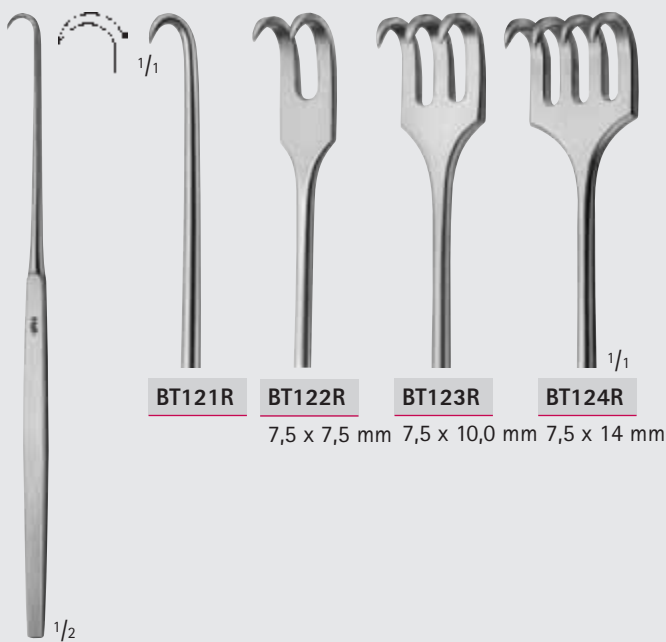
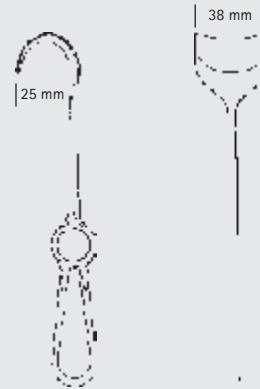

BT121R

BT122R

BT123R

BT124R

7,5 x 7,5 mm 7,5 x 10,0 mm 7,5 x 14 mm

BT121R–BT124R

weite Biegung, scharf
large curve, sharp

165 mm, 6 1/2"

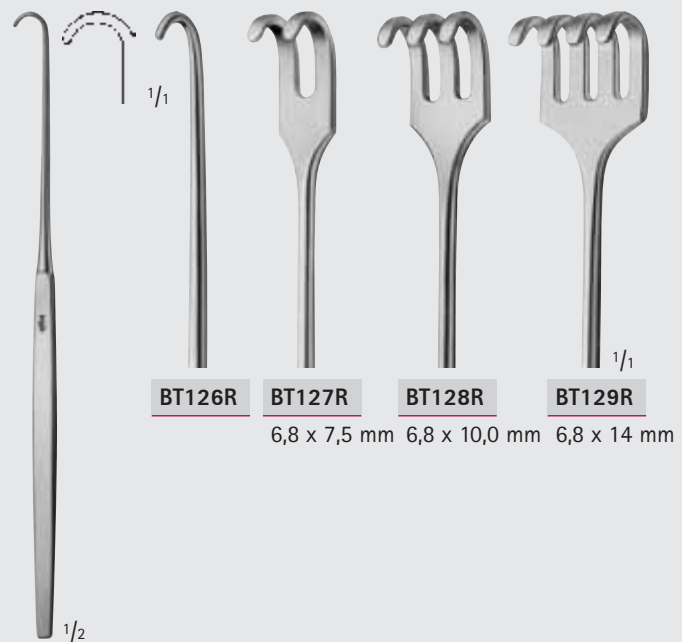

BT126R

BT127R

BT128R

BT129R

6,8 x 7,5 mm 6,8 x 10,0 mm 6,8 x 14 mm

BT126R–BT129R

weite Biegung, stumpf
large curve, blunt

165 mm, 6 1/2"



Wundhaken – Wound Retractors

Wundhaken mit Treangle-Griff
Retractors with Treangle Handle

BT

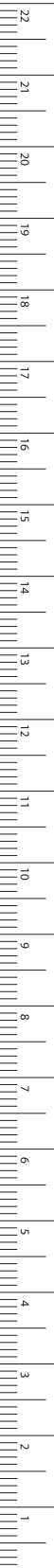

MILLIMETERS

BT901R
scharf
sharp
135 mm, 5 1/4"

BT902R
scharf
sharp
155 mm, 6"

BT904R
scharf
sharp
155 mm, 6"

BT906R
8,0 x 12,5 mm

BT908R
10,2 x 21,5 mm

BT906R-BT908R
Gabelhaken, retrograd gebogen
Forked hooks, retrograded curved
155 mm, 6"

BT911R

BT912R
5,0 x 4,0 mm

BT913R
5,5 x 7,2 mm

BT911R-BT913R
enge Biegung, scharf
small curve, sharp
155 mm, 6"

BT916R

BT917R
5,5 x 4,0 mm

BT918R
5,5 x 7,2 mm

BT916R-BT918R
enge Biegung, stumpf
small curve, blunt
155 mm, 6"

BT921R

BT922R
8,0 x 8,0 mm

BT923R
7,0 x 11,0 mm

BT921R-BT923R
weite Biegung, scharf
large curve, sharp
155 mm, 6"

BT926R

BT927R
7,0 x 8,0 mm

BT928R
7,0 x 11,0 mm

BT926R-BT928R
weite Biegung, stumpf
large curve, blunt
155 mm, 6"

Wundhaken – Wound Retractors

Wundhaken mit Treangle Griff

Retractors with Treangle Handle

Maßangaben für Blattgrößen der Wundhaken

1. Zahl = Tiefe Beispiel: 25 x 38 mm

2. Zahl = Breite

Dimensions for blade size of retractors

1st number = depth Example: 25 x 38 mm

2nd number = width

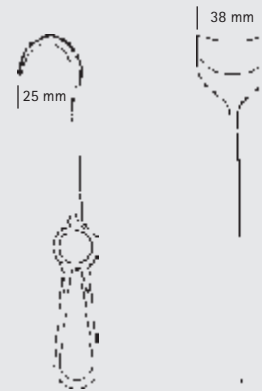

MANNERFELT MODIF.

BT933R

flexibler Schaft,
enge Biegung, scharf
flexible shaft,
small curve, sharp
155 mm, 6"



MANNERFELT MODIF.

BT940R

hohlgekehlt
hollow grooved
155 mm, 6"

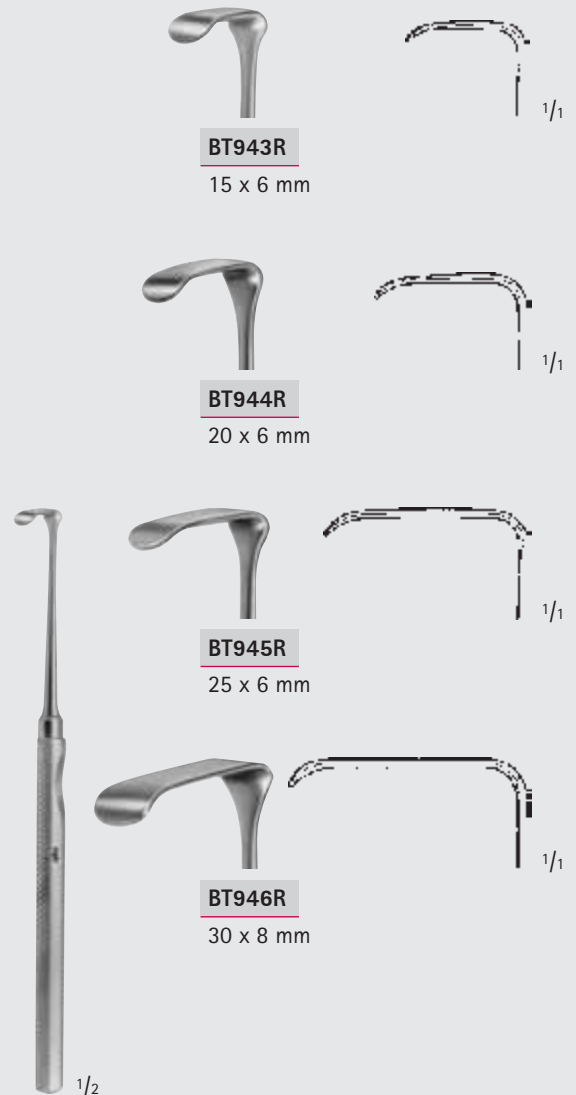

LANGENBECK-MANNERFELT MODIF.

BT943R-BT946R

155 mm, 6"



Wundhaken – Wound Retractors

Wundhaken mit Treangle-Griff
Retractors with Treangle Handle

BT

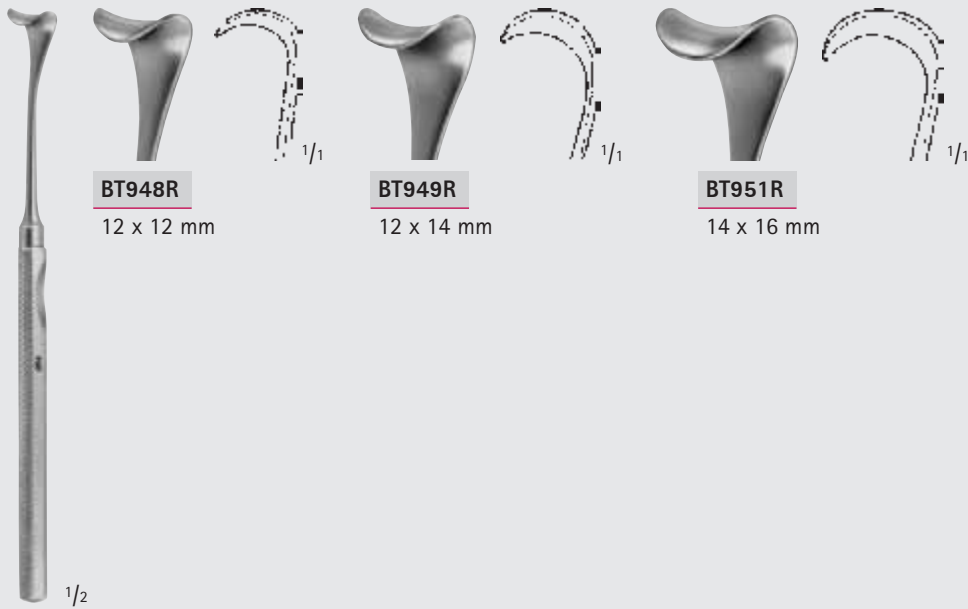

BT948R

12 x 12 mm

BT949R

12 x 14 mm

BT951R

14 x 16 mm

MANNERFELT MODIF.

BT948R-BT951R

Sattelhaken
Saddle hooks
155 mm, 6"



12 x 12 mm

MANNERFELT MODIF.

BT958R

Sattelhaken, gefenstert
Saddle hook, fenestrated
155 mm, 6"



MANNERFELT MODIF.

BT964R

Sehnen-Doppelhaken
Tendon double hook
160 mm, 6 1/4"



MANNERFELT MODIF.

BT966R

Doppelspatel
Spatula, double-ended
160 mm, 6 1/4"

MILLIMETERS

Wundhaken – Wound Retractors

Wundhaken

Retractors

Maßangaben für Blattgrößen der Wundhaken

1. Zahl = Tiefe Beispiel: 25 x 38 mm

2. Zahl = Breite

Dimensions for blade size of retractors

1st number = depth Example: 25 x 38 mm

2nd number = width

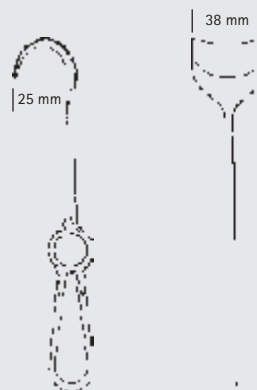

BT



FOMON

OL202R

145 mm, 5 3/4"

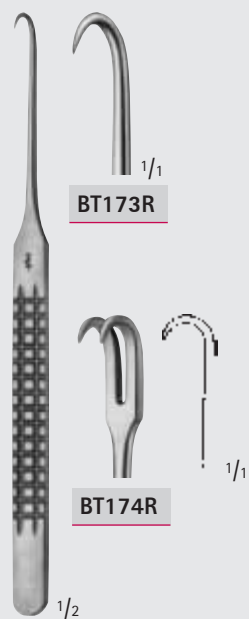

BT173R

BT174R

BT173R-BT174R

160 mm, 6 1/4"



BT177R

BT178R

LANGENBECK-GREEN

BT177R-BT178R

160 mm, 6 1/4"

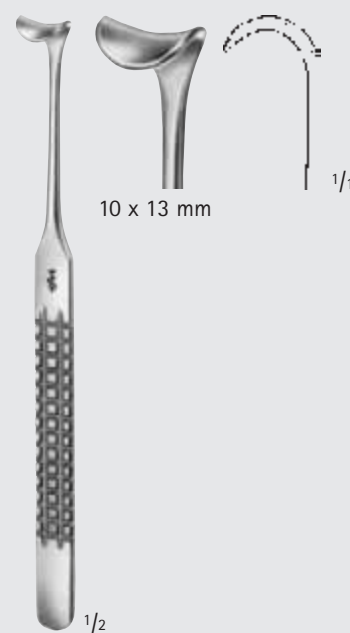

10 x 13 mm

BT179R

160 mm, 6 1/4"



Wundhaken – Wound Retractors
Wundhaken
Retractors

BT

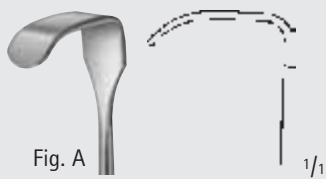
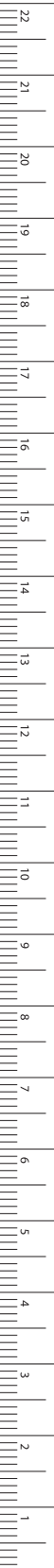

Fig. A

BT193R

18 x 7 mm



Fig. B

BT194R

16 x 5 mm

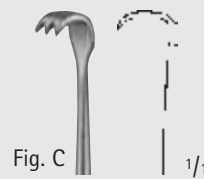

Fig. C

BT195R

7 x 4 mm



Fig. D

BT196R

5 x 10 mm



Fig. E

BT197R

11 x 4 mm

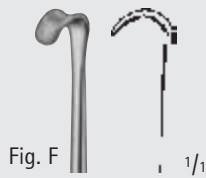

Fig. F

BT198R

6 x 4 mm



1/2

MEYERDING

BT193R-BT198R

Fig. A - Fig. F
180 mm, 7"

MILLIMETERS

Wundhaken – Wound Retractors

Wundhaken

Retractors

Maßangaben für Blattgrößen der Wundhaken

1. Zahl = Tiefe Beispiel: 25 x 38 mm

2. Zahl = Breite

Dimensions for blade size of retractors

1st number = depth Example: 25 x 38 mm

2nd number = width

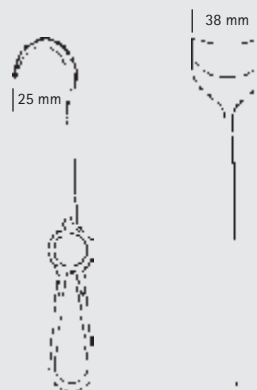

EMMET

BT161R

Fistelhaken

Fistula hook

220 mm, 8 3/4"



SIMON

BT166R

Fistelhaken

Fistula hook



SIMON

BT167R

Fistelhaken

Fistula hook

220 mm, 8 3/4"



LANGE

OL201R

Fistelhaken

Fistula hook

235 mm, 9"



Wundhaken – Wound Retractors

Wundhaken
Wound Retractors

BT

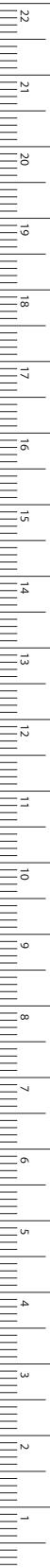

MILLIMETERS

11 x 8 mm

1/2

PAUL

OA340R

Sehnenscheidenhaken
Tendon hook
120 mm, 4 3/4"

12 x 6 mm

1/1

BT170R

12 x 11 mm

1/1

BT171R

1/2

BT170R-BT171R

Sehnenscheidenhaken
Tendon hooks
175 mm, 7"

15 x 11 mm

1/1

1/2

KLAPP

BT172R

Sehnenscheidenhaken
Tendon hook
175 mm, 7"

15 x 6 mm
stumpf
blunt

1/1

BT180R

15 x 6 mm
gezahnt
toothed

1/1

BT181R

1/2

STRANDELL-STILLE

BT180R-BT181R

Sehnenscheidenhaken
Tendon hooks
180 mm, 7"

6 x 12 mm

1/1

1/2

MASING

OL211R

140 mm, 5 1/2"

10 x 12 mm

1/1

1/2

COTTLE

OL212R

140 mm, 5 1/2"

9 x 9 mm

OA310R

9 x 12 mm

OA311R

11 x 14 mm

1/1

OA312R

12 x 16 mm

OA313R

13 x 18 mm

1/1

OA314R

1/2

DESMARRES

OA310R-OA314R

140 mm, 5 1/2"

Wundhaken – Wound Retractors

Wund- und Venenhaken

Wound- and Vein Retractors

Maßangaben für Blattgrößen der Wundhaken

1. Zahl = Tiefe Beispiel: 25 x 38 mm

2. Zahl = Breite

Dimensions for blade size of retractors

1st number = depth Example: 25 x 38 mm

2nd number = width

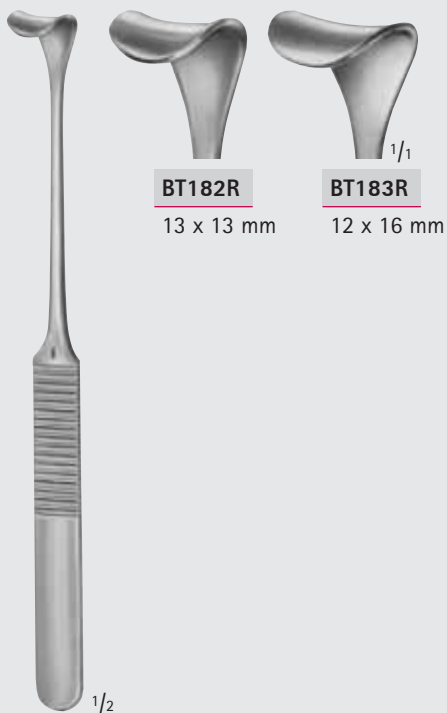
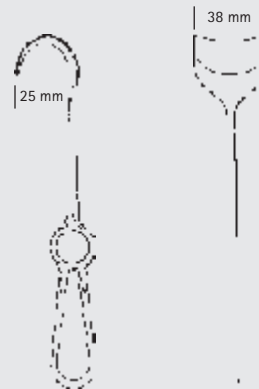

KÖNIG

BT182R-BT183R

180 mm, 7"



CUSHING-KOCHER

BT190R

175 mm, 7"

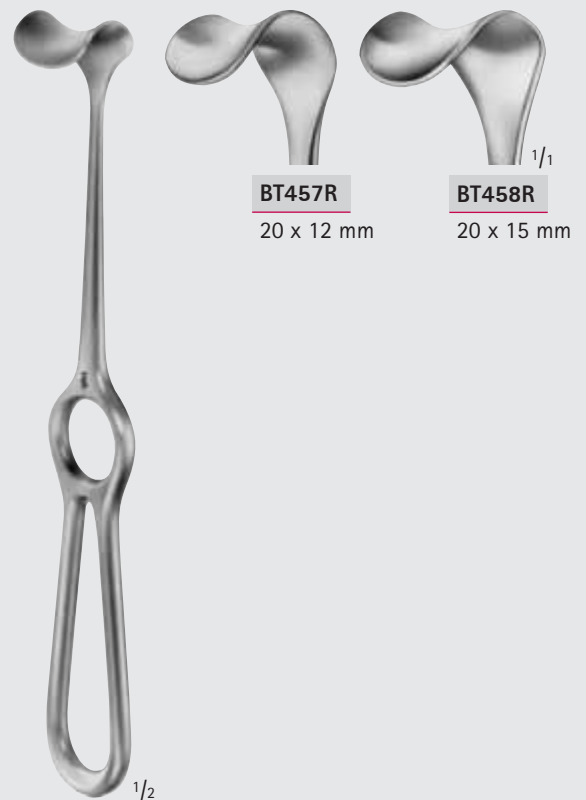

KOCHER

BT457R-BT458R

205 mm, 8"



Wundhaken – Wound Retractors
 Wund- und Venenhaken
 Wound- and Vein Retractors

BT

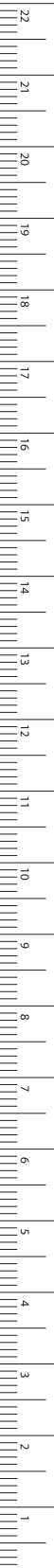

MILLIMETERS



$\frac{1}{1}$
13 x 6 mm

$\frac{1}{2}$
SCHOENBORN

BT192R

200 mm, 8"

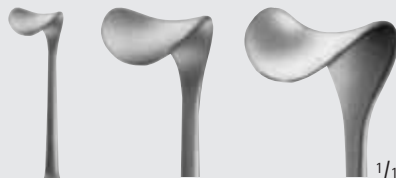

BT184R

10 x 13 mm

$\frac{1}{1}$
BT185R

14 x 18 mm

$\frac{1}{2}$
CUSHING

BT184R-BT185R

205 mm, 8"

20 x 15 mm

20 x 19 mm
 $\frac{1}{2}$

BT187R

205 mm, 8"

Wundhaken – Wound Retractors

Wund- und Venenhaken

Wound- and Vein Retractors

Maßangaben für Blattgrößen der Wundhaken

1. Zahl = Tiefe Beispiel: 25 x 38 mm

2. Zahl = Breite

Dimensions for blade size of retractors

1st number = depth Example: 25 x 38 mm

2nd number = width

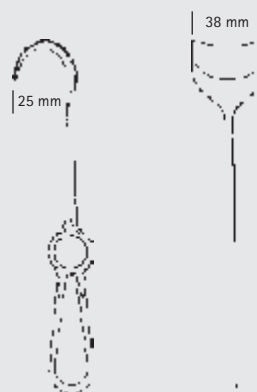

CUSHING

BT200R–BT202R

250 mm, 10"



BT206R

Präparationshäkchen
Small dissecting hook
235 mm, 9 1/4"



HESS

FF707R–FF709R

Nervwurzelhaken
Nerve root retractors
175 mm, 7"

BT





Wundhaken – Wound Retractors
Wundhaken
Retractors

BT

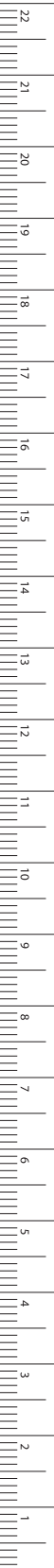

MILLIMETERS

5 x 10 mm



13 x 5 mm



KILNER

BT005R

155 mm, 6"

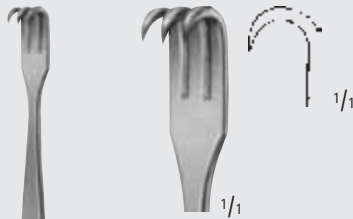

BT006R

8 x 7 mm



BT007R

8 x 7 mm

22 x 7 mm

BABY-SENN-MILLER

BT006R-BT007R

155 mm, 6"

8 x 7 mm



18 x 5,5 mm

SENN-MILLER

BT008R

165 mm, 6 1/2"

Wundhaken – Wound Retractors

Wundhaken

Retractors

Maßangaben für Blattgrößen der Wundhaken

1. Zahl = Tiefe Beispiel: 25 x 38 mm

2. Zahl = Breite

Dimensions for blade size of retractors

1st number = depth Example: 25 x 38 mm

2nd number = width

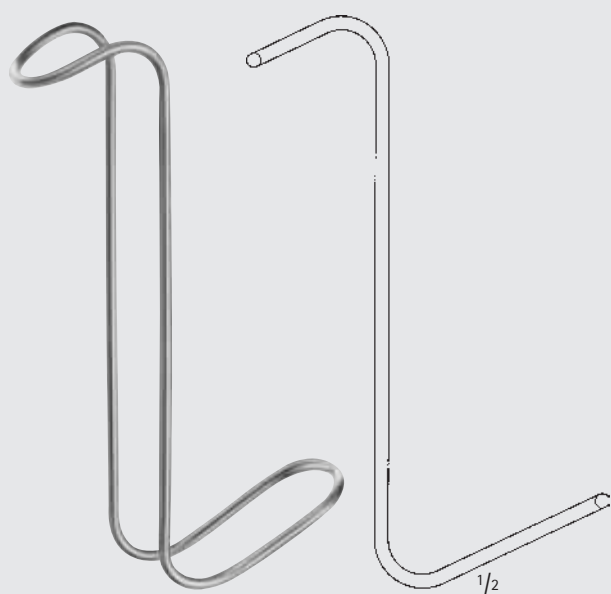
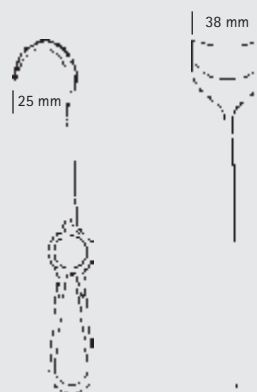

COLLIN-HARTMANN

BT001R

150 mm, 6"

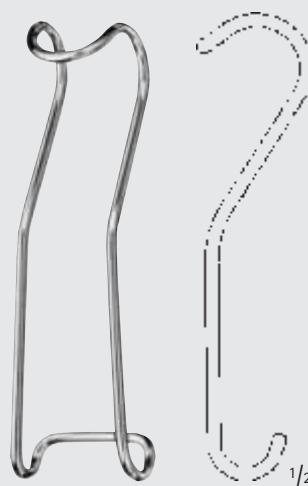

STERNBERG

OM251R	OM252R	OM253R
120 mm	130 mm	135 mm
4 1/4"	5"	5 1/4"

BT





Wundhaken – Wound Retractors

Wundhaken
Retractors

BT

10 x 8 mm

12 x 11 mm

LUER

BT010R

110 mm, 4 3/8"

10 x 12 mm

11 x 15 mm

ROSE

BT011R

130 mm, 5 1/8"

17 x 16 mm

18 x 22 mm

BABY-ROUX

BT019R

135 mm, 5 1/4"

22 x 15 mm
18 x 15 mm

18 x 15 mm
22 x 15 mm

PARKER

BT025R

135 mm, 5 1/4"

5 x 3 mm

14 x 6,3 mm

RAGNELL

BT004R

150 mm, 6"

11 x 4 mm

19 x 6 mm

CRILE

BT012R

110 mm, 4 3/8"

25 x 10 mm
22 x 10 mm

28 x 12 mm
32 x 12 mm

FARABEUW

BT020R

125 mm, 5"

23 x 16 mm
20 x 16 mm

24 x 16 mm
28 x 16 mm

FARABEUW

BT021R

150 mm, 6"



MILLIMETERS

Wundhaken – Wound Retractors

Wundhaken
Retractors

Maßangaben für Blattgrößen der Wundhaken

1. Zahl = Tiefe Beispiel: 25 x 38 mm

2. Zahl = Breite

Dimensions for blade size of retractors

1st number = depth Example: 25 x 38 mm

2nd number = width

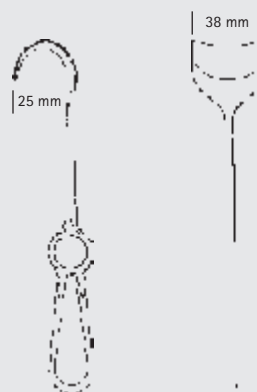

36 x 44 mm
30 x 24 mm



36 x 44 mm
30 x 24 mm

PARKER

BT026R

180 mm, 7"

21 x 14 mm
17 x 14 mm



28 x 16 mm
32 x 16 mm

COLLIN

BT022R

150 mm, 6"

BT





Wundhaken – Wound Retractors

Wundhaken
Retractors

BT

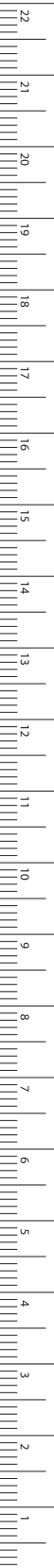

MILLIMETERS



ROUX

BT030R-BT033R

Satz komplett
bestehend aus:

Set complete,
consisting of:

BT031R

BT032R

BT033R

165 mm, 6 1/2"

19 x 22 mm



23 x 30 mm

BT031R

25 x 26 mm

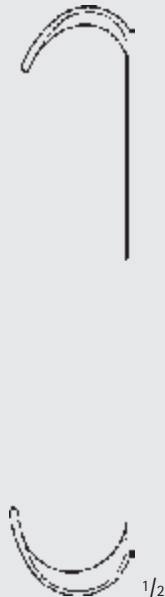

28 x 38 mm

BT032R

28 x 29 mm

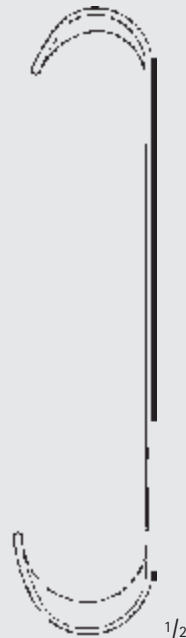

33 x 45 mm

BT033R

Wundhaken – Wound Retractors

Wundhaken
Retractors

Maßangaben für Blattgrößen der Wundhaken

1. Zahl = Tiefe Beispiel: 25 x 38 mm

2. Zahl = Breite

Dimensions for blade size of retractors

1st number = depth Example: 25 x 38 mm

2nd number = width

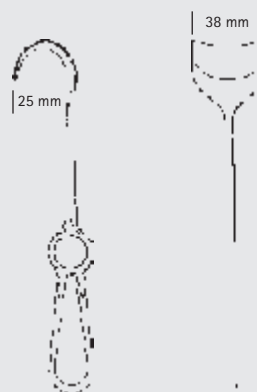

28 x 24 mm



43 x 24 mm

ROUX

BT028R

170 mm, 6 3/4"

28 x 28 mm



46 x 28 mm

ROUX

BT029R

190 mm, 7 1/2"

BT





Wundhaken – Wound Retractors
Wundhaken
Retractors

BT

30 x 19 mm

33 x 25 mm

KILNER

OL219R

150 mm, 6"

35 x 29 mm

40 x 35 mm

KILNER

OL220R

150 mm, 6"

20 x 22 mm

25 x 29 mm

ROUX

BT034R

150 mm, 6"

25 x 26 mm

30 x 38 mm

ROUX

BT035R

160 mm, 6 1/4"

28 x 29 mm

33 x 44 mm

ROUX

BT036R

170 mm, 6 3/4"



Wundhaken – Wound Retractors

Wundhaken
Retractors

Maßangaben für Blattgrößen der Wundhaken

1. Zahl = Tiefe Beispiel: 25 x 38 mm

2. Zahl = Breite

Dimensions for blade size of retractors

1st number = depth Example: 25 x 38 mm

2nd number = width

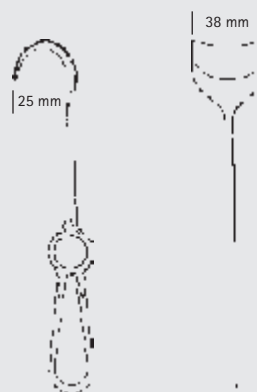

30 x 13 mm

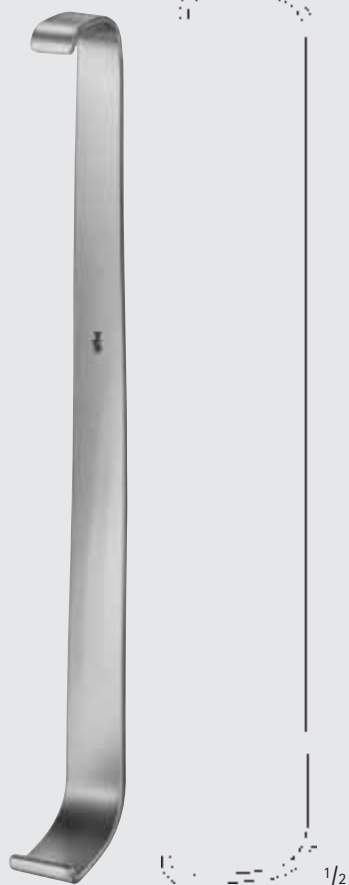

35 x 19 mm

LANE

BT037R

230 mm, 9"

30 x 25 mm

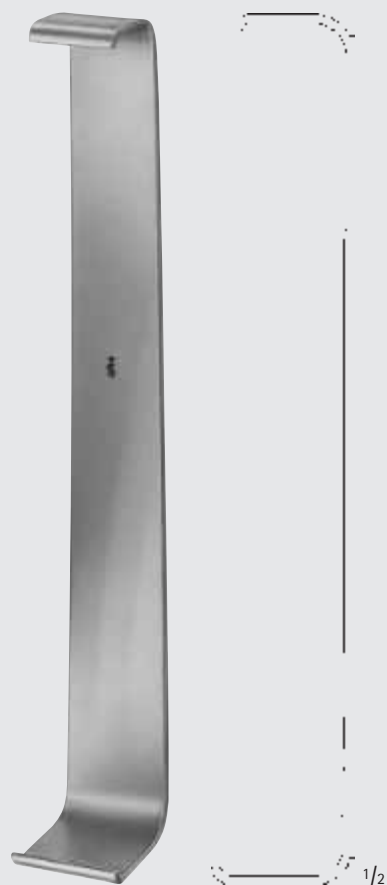

35 x 32 mm

LANE

BT038R

230 mm, 9"

38 x 22 mm

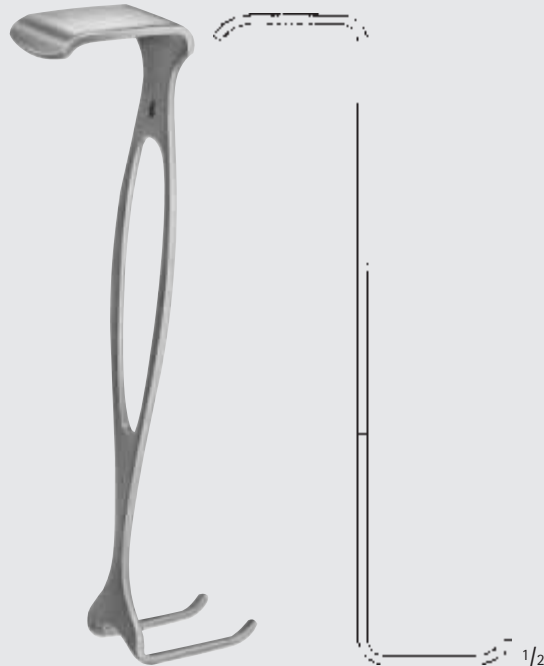

38 x 22 mm

CZERNY

BT042R

175 mm, 7"





Wundhaken – Wound Retractors
Wundhaken
Retractors

BT

30 x 18 mm

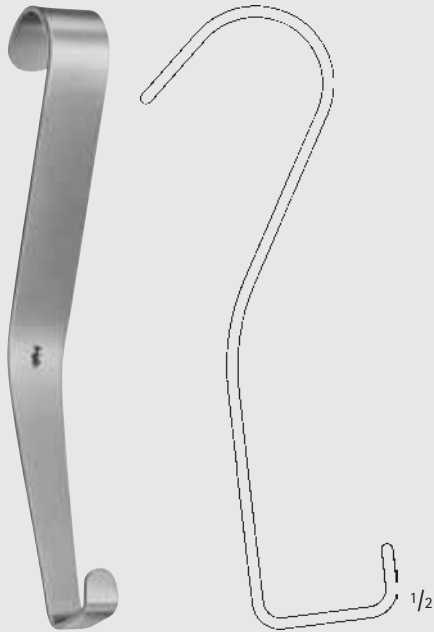

25 x 10 mm

HAJEK

OL221R

165 mm, 6 1/2"

47 x 13 mm
41 x 13 mm



37 x 25 mm
45 x 25 mm

MATHIEU

BT040R

200 mm, 8"

38 x 22 mm

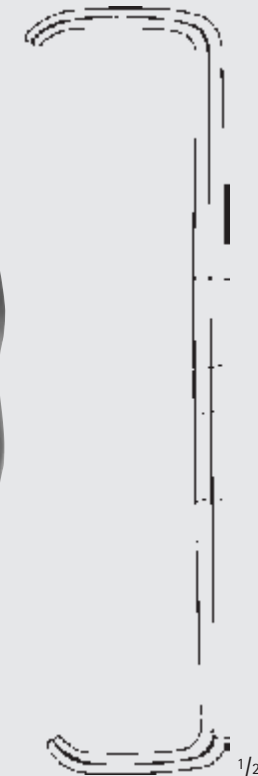

38 x 22 mm

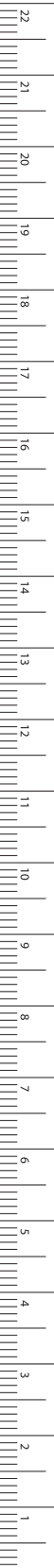

Wundhaken – Wound Retractors

Wundhaken
Retractors

Maßangaben für Blattgrößen der Wundhaken

1. Zahl = Tiefe Beispiel: 25 x 38 mm

2. Zahl = Breite

Dimensions for blade size of retractors

1st number = depth Example: 25 x 38 mm

2nd number = width

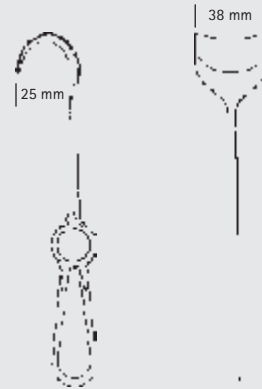

26 x 15 mm
22 x 15 mm

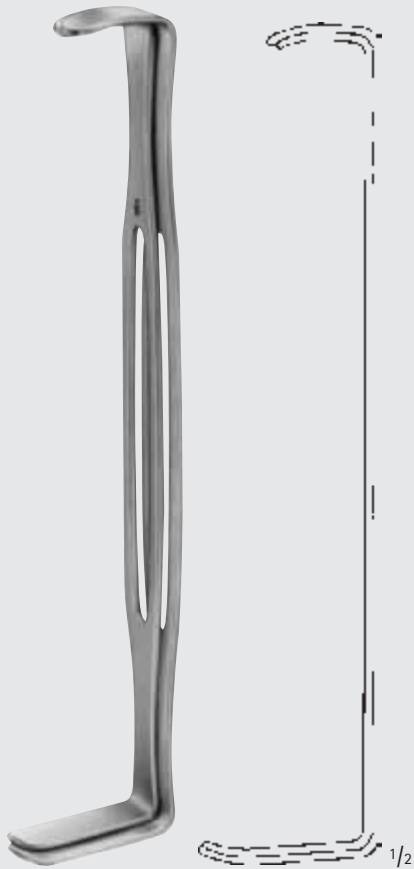

39 x 15 mm
43 x 15 mm

US-ARMY

BT041R

220 mm, 8 3/4"



GOELET

MD497

190 mm, 7 1/2"



CANNY-RYALL

Blattbreite
Blade width

BT047R	190 mm, 7 1/2"	16 mm
BT048R	190 mm, 7 1/2"	20 mm
BT049R	200 mm, 8"	25 mm

BT





Wundhaken – Wound Retractors

Knochen- und Wundhaken
Bone Retractors and Retractors

BT



KOCHER
BT234R
scharf
sharp
205 mm, 8"



KOCHER
BT238R
scharf
sharp
220 mm, 8 3/4"



KOCHER
BT239R
stumpf
blunt
220 mm, 8 3/4"



VOLKMANN
BT240R
scharf
sharp
220 mm, 8 3/4"



VOLKMANN
BT241R
stumpf
blunt
220 mm, 8 3/4"



BT232R
scharf
sharp
245 mm, 9 3/4"

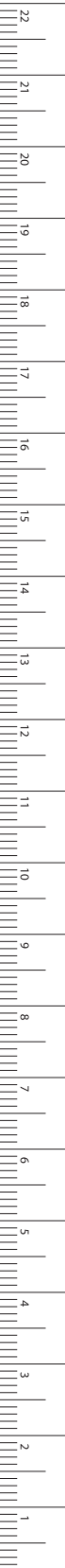

MILLIMETERS

Wundhaken – Wound Retractors

Knochen- und Wundhaken

Bone Retractors and Retractors

Maßangaben für Blattgrößen der Wundhaken

1. Zahl = Tiefe Beispiel: 25 x 38 mm

2. Zahl = Breite

Dimensions for blade size of retractors

1st number = depth Example: 25 x 38 mm

2nd number = width

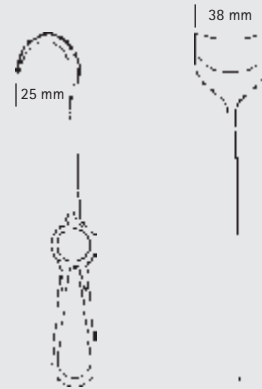

VOLKMANN

BT221R

scharf

sharp

220 mm, 8 3/4"

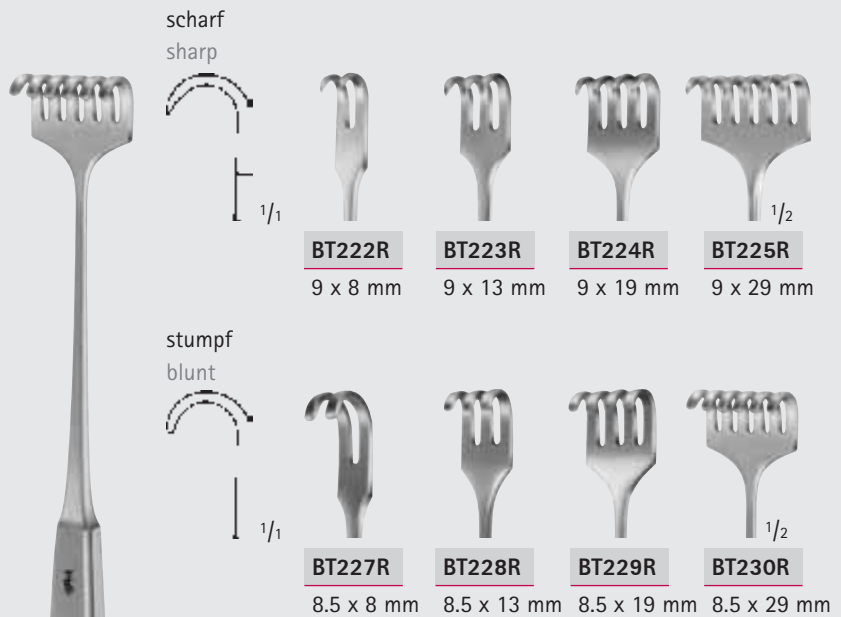

VOLKMANN

BT222R-BT230R

225 mm, 9"

BT





Wundhaken – Wound Retractors

Wundhaken
Retractors

BT

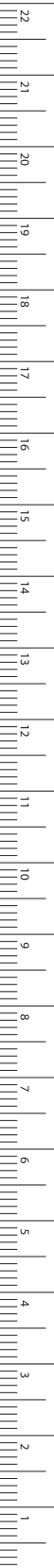

scharf
sharp

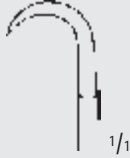

BT242R
9 x 8 mm



BT243R
9 x 13 mm



BT244R
9 x 19 mm



BT246R
9 x 29 mm



BT248R
9 x 40 mm

stumpf
blunt

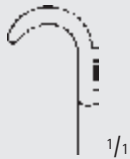

BT252R
8 x 8 mm



BT253R
8 x 13 mm



BT254R
8 x 19 mm



BT256R
8 x 29 mm



BT258R
8 x 40 mm

halbscharf
semi-sharp



BT257R
8.5 x 8 mm



BT259R
8.5 x 13 mm



BT260R
8.5 x 19 mm



BT261R
8.5 x 29 mm



BT265R
8,5 x 40 mm



VOLKMANN

BT242R-BT265R

220 mm, 8 3/4"

Wundhaken – Wound Retractors

Wundhaken

Retractors

Maßangaben für Blattgrößen der Wundhaken

1. Zahl = Tiefe Beispiel: 25 x 38 mm

2. Zahl = Breite

Dimensions for blade size of retractors

1st number = depth Example: 25 x 38 mm

2nd number = width

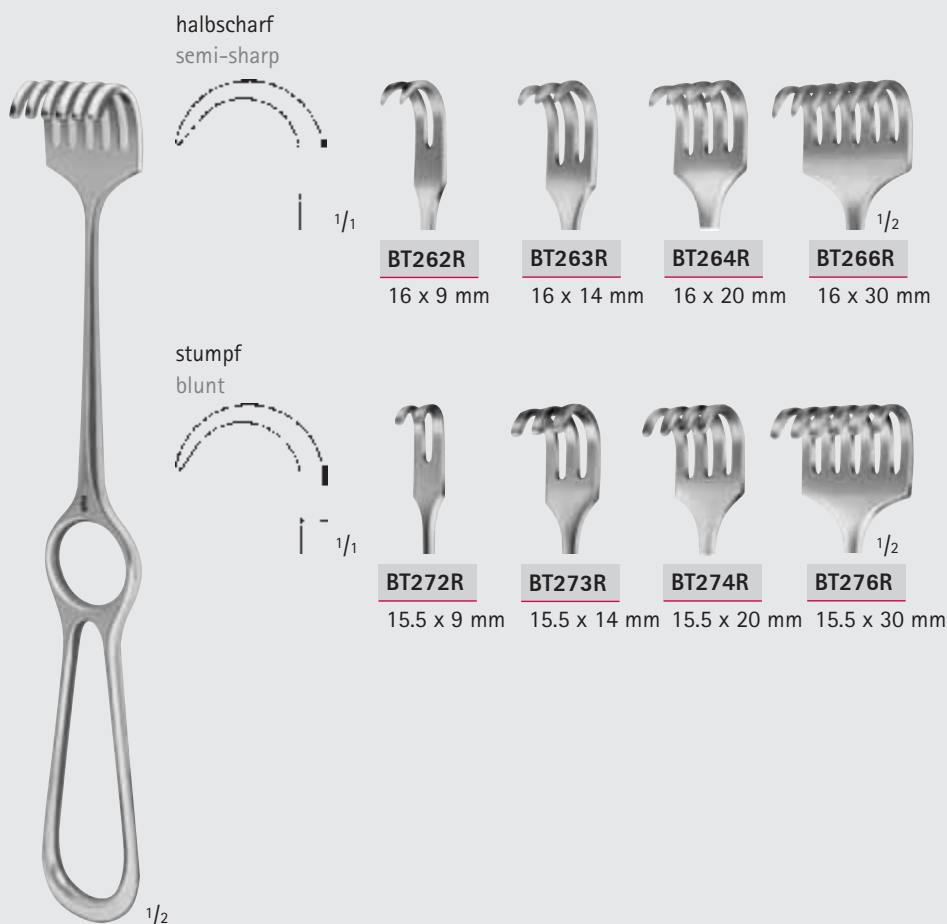
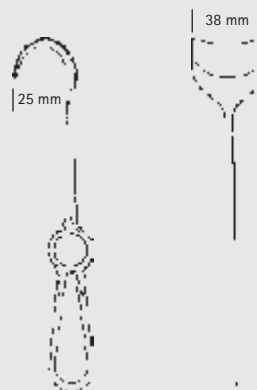

KOCHER

BT262R-BT276R

220 mm, 8 3/4"

BT





Wundhaken – Wound Retractors

Wundhaken
Retractors

BT

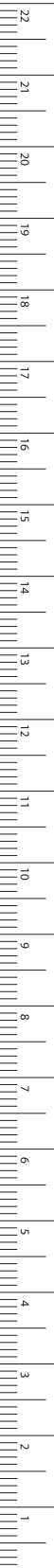

MILLIMETERS

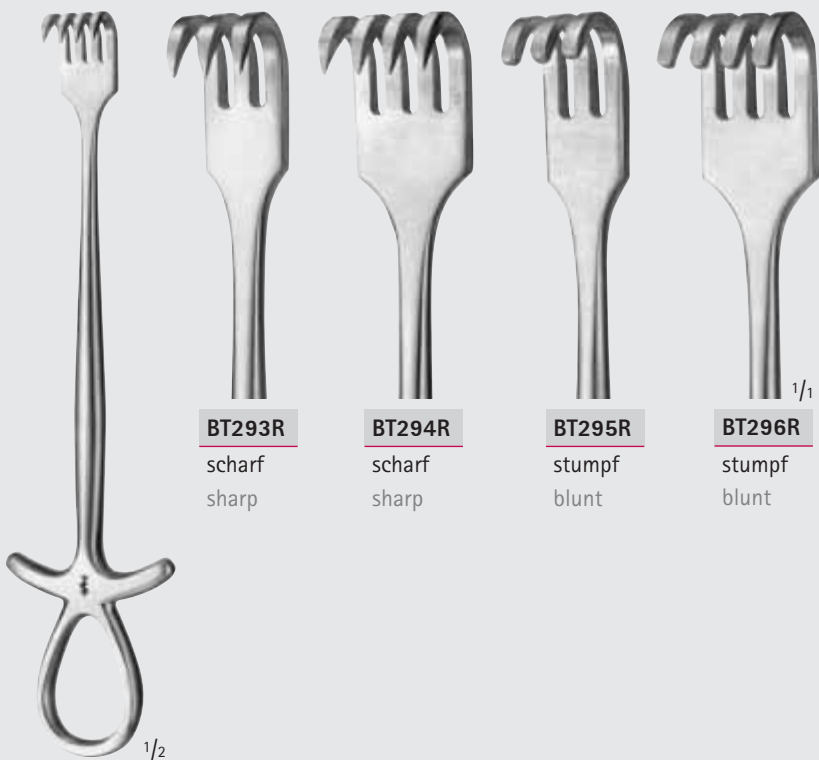

BT293R

scharf
sharp

BT294R

scharf
sharp

BT295R

stumpf
blunt

BT296R

stumpf
blunt

¹/₂

¹/₁

MURPHY

BT293R–BT296R

195 mm, 7 ³/₄"

Wundhaken – Wound Retractors

Wundhaken, tiefe Form

Retractors, Deep Form

Maßangaben für Blattgrößen der Wundhaken

1. Zahl = Tiefe Beispiel: 25 x 38 mm

2. Zahl = Breite

Dimensions for blade size of retractors

1st number = depth Example: 25 x 38 mm

2nd number = width

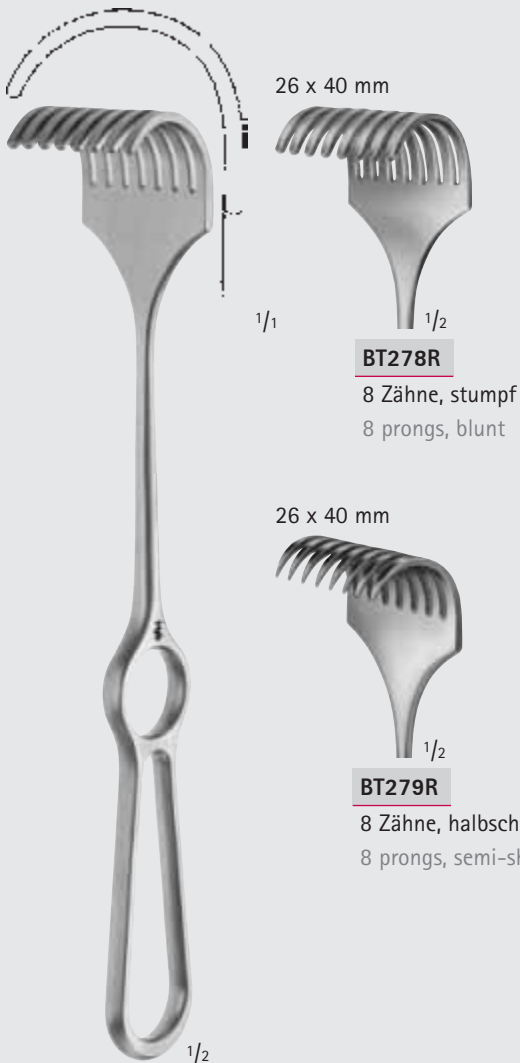
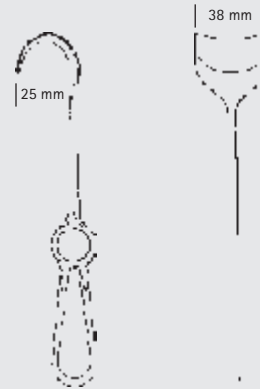

BT278R

8 Zähne, stumpf
8 prongs, blunt

BT279R

8 Zähne, halbscharf
8 prongs, semi-sharp

KÖRTE

BT278R-BT279R

Griff vertikal zum Blatt
Handle vertical to the blade
240 mm, 9 1/2"



BT280R

4 Zähne, stumpf
Griff vertikal zum Blatt
4 prongs, blunt
handle vertical to the blade
230 mm, 9"

KÖRTE



BT290R

8 Zähne, halbscharf
8 prongs, semi-sharp
280 mm, 11"

KÖRTE-WAGNER



Wundhaken – Wound Retractors

Wundhaken, tiefe Form
Retractors, Deep Form

BT

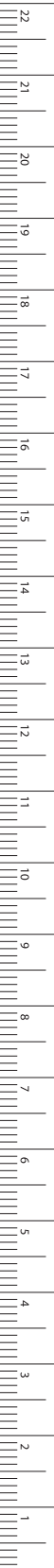

MILLIMETERS



1/2

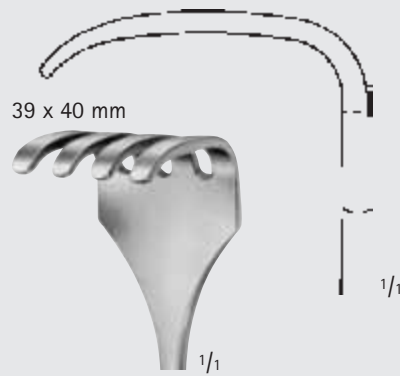

39 x 40 mm

BT284R

4 Zähne, stumpf
4 prongs, blunt

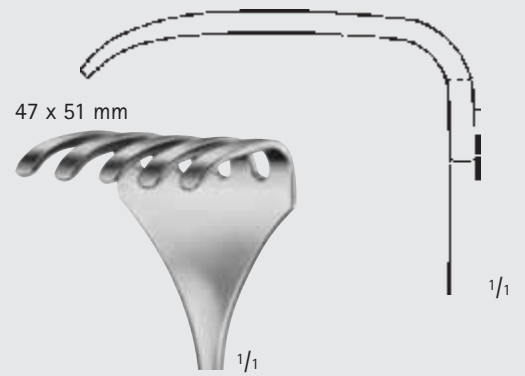

47 x 51 mm

BT285R

5 Zähne, stumpf
5 prongs, blunt

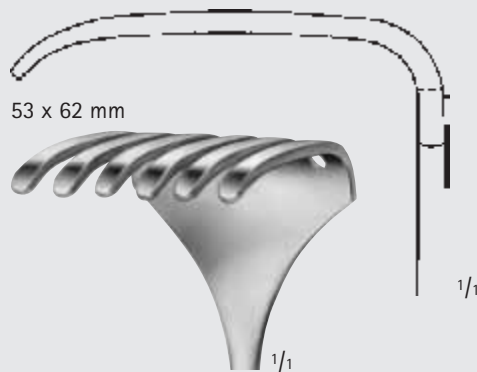

53 x 62 mm

BT286R

6 Zähne, stumpf
6 prongs, blunt

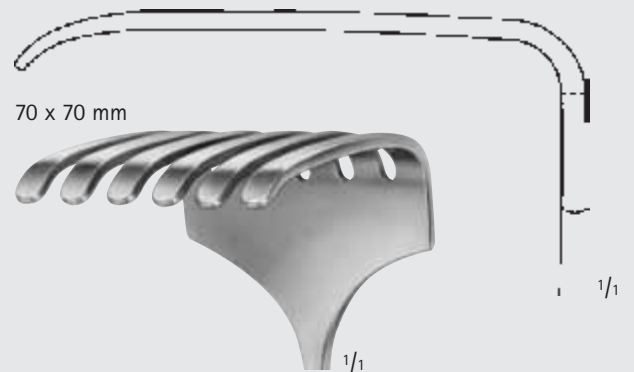

70 x 70 mm

BT287R

6 Zähne, stumpf
6 prongs, blunt

ISRAEL

BT284R-BT287R

255 mm, 10"

Wundhaken – Wound Retractors

Wundhaken

Retractors

Maßangaben für Blattgrößen der Wundhaken

1. Zahl = Tiefe Beispiel: 25 x 38 mm

2. Zahl = Breite

Dimensions for blade size of retractors

1st number = depth Example: 25 x 38 mm

2nd number = width

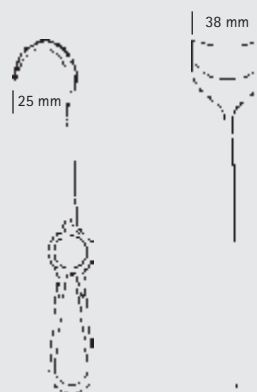

OLLIER

BT288R

4 Zähne, stumpf

4 prongs, blunt

230 mm, 9"



LANGENBECK

BT311R-BT316R

230 mm, 9"

BT311R

30 x 10 mm

BT315R

40 x 10 mm

BT316R

43 x 13 mm



Wundhaken – Wound Retractors

Wundhaken
Retractors

BT

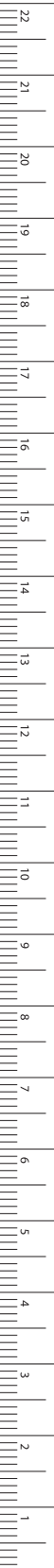

MILLIMETERS



LANGENBECK

BT320R-BT326R

210 mm, 8 1/4"

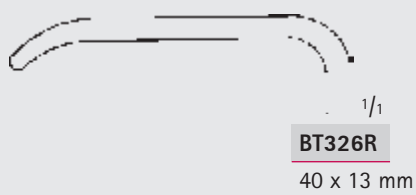
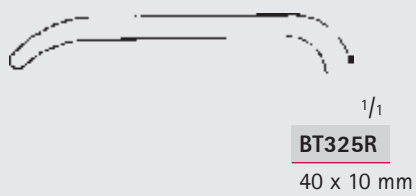
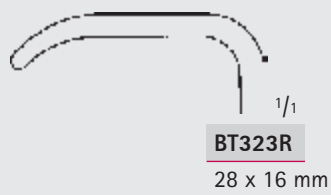

Wundhaken – Wound Retractors

Wundhaken
Retractors

Maßangaben für Blattgrößen der Wundhaken

1. Zahl = Tiefe Beispiel: 25 x 38 mm

2. Zahl = Breite

Dimensions for blade size of retractors

1st number = depth Example: 25 x 38 mm

2nd number = width

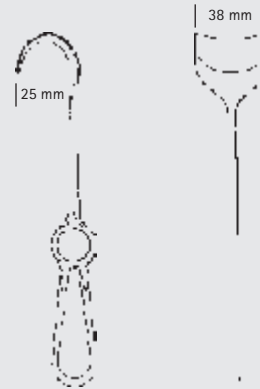

KOCHER-LANGENBECK

BT354R-BT365R

215 mm, 8 1/2"

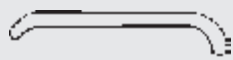

1/1

BT354R

25 x 6 mm



1/1

BT356R

35 x 8 mm



1/1

BT357R

35 x 11 mm

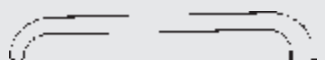

1/1

BT358R

35 x 15 mm

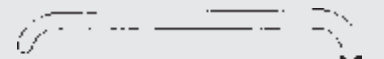

1/1

BT359R

41 x 11 mm



1/1

BT361R

55 x 11 mm



1/1

BT363R

70 x 14 mm



1/1

BT364R

80 x 12 mm

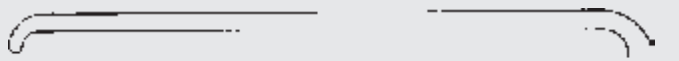

1/1

BT365R

80 x 16 mm



Wundhaken – Wound Retractors

Wundhaken
Retractors

BT

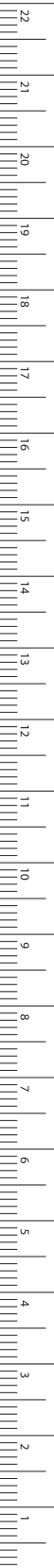

MILLIMETERS

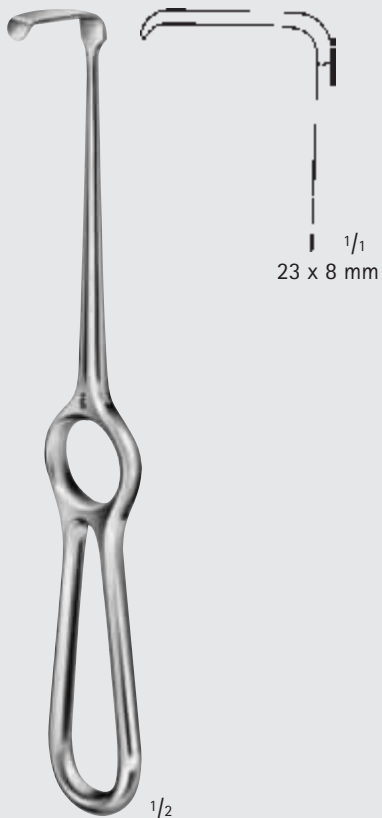

BT340R

210 mm, 8 1/4"

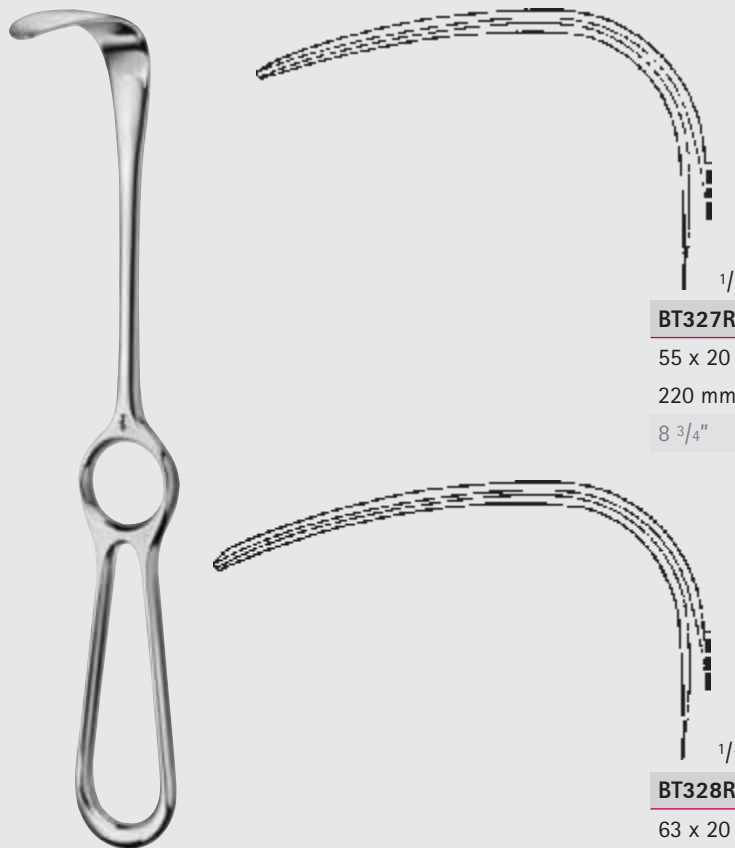

BT327R

55 x 20 mm

220 mm

8 3/4"

BT328R

63 x 20 mm

210 mm

8 1/4"

BT327R-BT328R

Wundhaken – Wound Retractors

Wundhaken

Retractors

Maßangaben für Blattgrößen der Wundhaken

1. Zahl = Tiefe Beispiel: 25 x 38 mm

2. Zahl = Breite

Dimensions for blade size of retractors

1st number = depth Example: 25 x 38 mm

2nd number = width

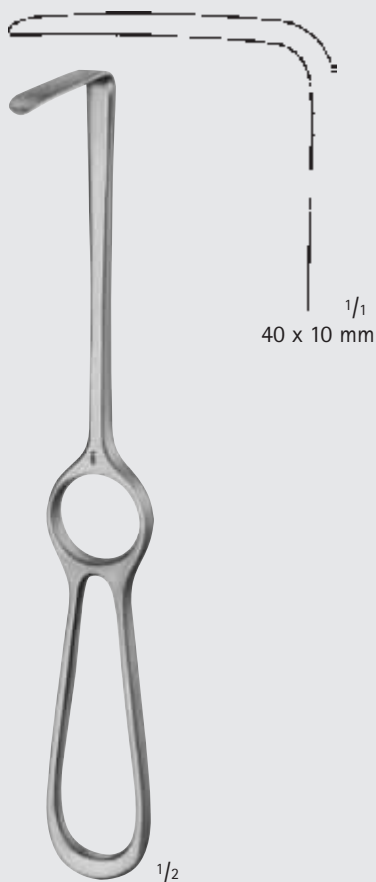
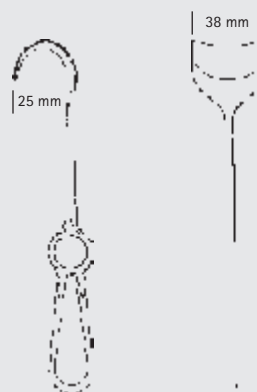

BT343R

215 mm, 8 1/2"



LANGENBECK

BT332R

Griff vertikal zum Blatt

Handle vertical to the blade

215 mm, 8 1/2"

BT





Wundhaken – Wound Retractors
 Wund- und Meniskushaken
 Retractors and Knee Retractors

BT

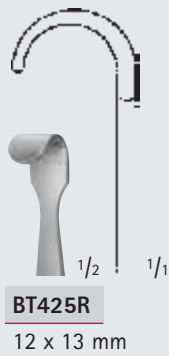
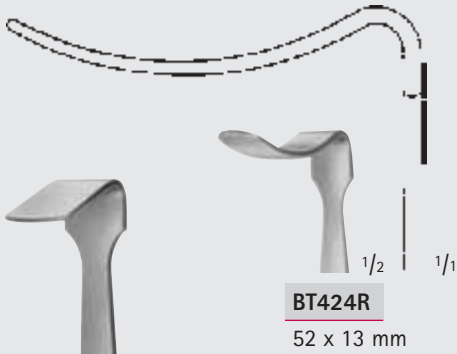
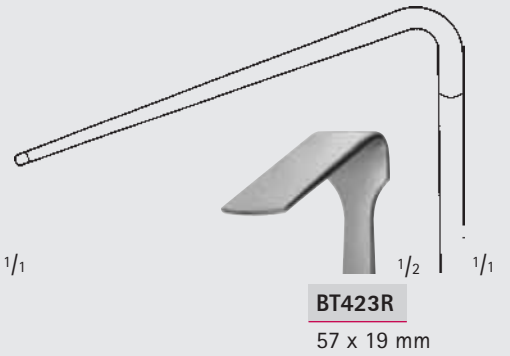
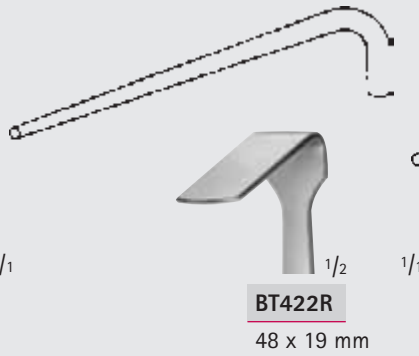
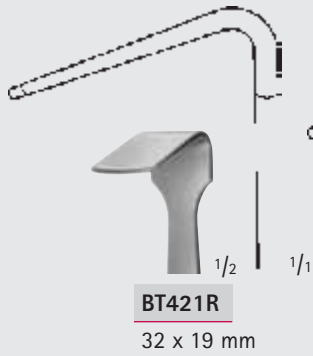
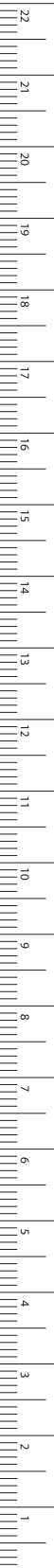

SMILLIE
BT421R-BT425R
 140 mm, 5 1/2"

MILLIMETERS

Wundhaken – Wound Retractors

Wund- und Meniskushaken

Retractors and Knee Retractors

Maßangaben für Blattgrößen der Wundhaken

1. Zahl = Tiefe Beispiel: 25 x 38 mm

2. Zahl = Breite

Dimensions for blade size of retractors

1st number = depth Example: 25 x 38 mm

2nd number = width

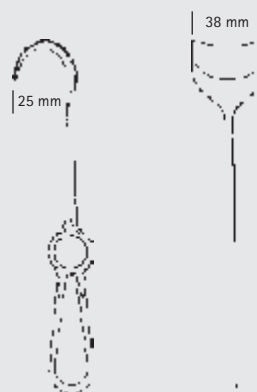

BT419R

225 mm, 9"

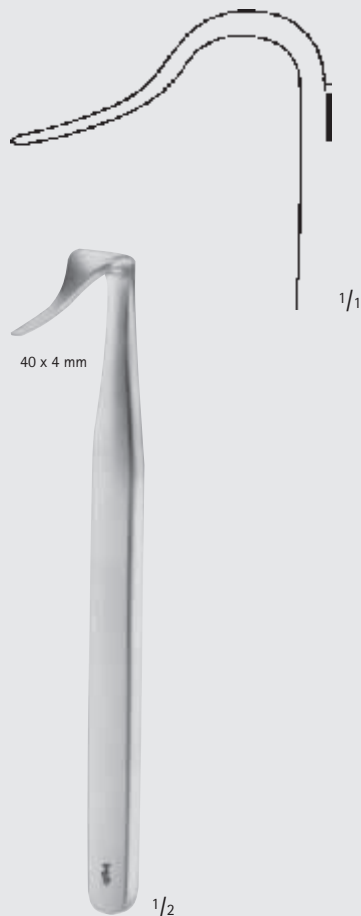

BLOUNT

BT420R

175 mm, 7"

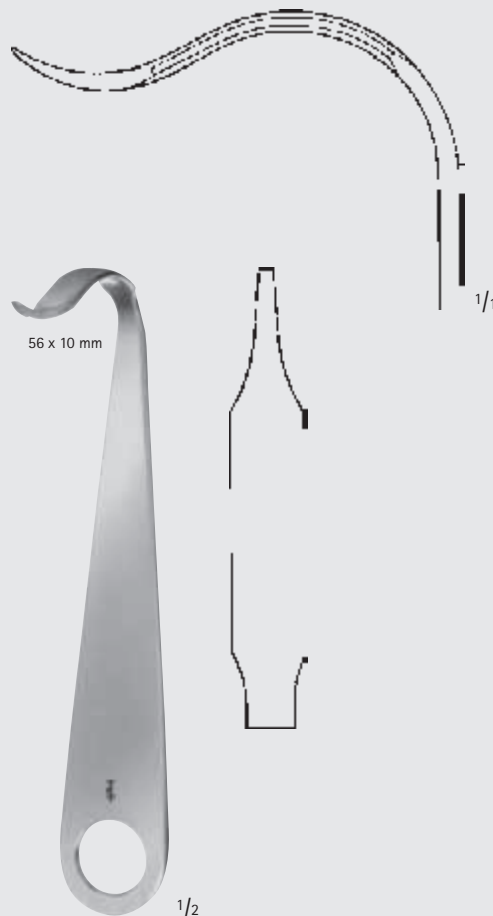

BT430R

170 mm, 6 3/4"





Wundhaken – Wound Retractors

Wundhaken
Retractors

BT

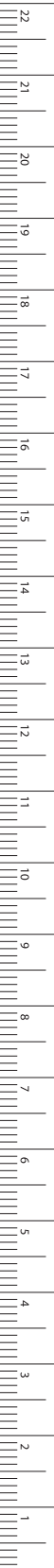

MILLIMETERS



1/2

OBWEGESER

DO450R-DO455R

215 mm, 8 1/2"

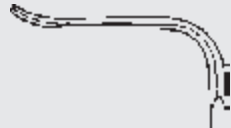

DO450R

25 x 7 mm



DO451R

31 x 10 mm

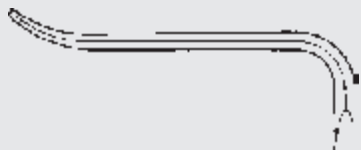

DO452R

42 x 11 mm



DO453R

55 x 12 mm

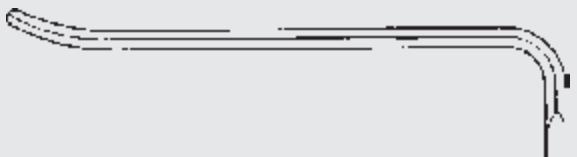

DO454R

70 x 14 mm

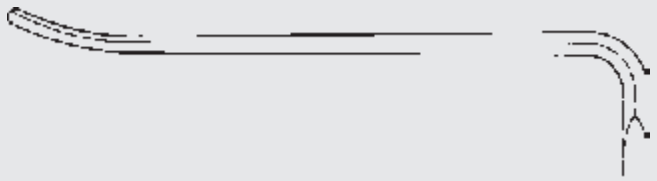

1/1

DO455R

80 x 16 mm

Wundhaken – Wound Retractors

Wundhaken
Retractors

Maßangaben für Blattgrößen der Wundhaken

1. Zahl = Tiefe Beispiel: 25 x 38 mm

2. Zahl = Breite

Dimensions for blade size of retractors

1st number = depth Example: 25 x 38 mm

2nd number = width

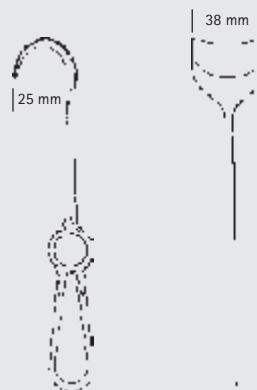

OBWEGESER

DO460R-DO465R

215 mm, 8 1/2"

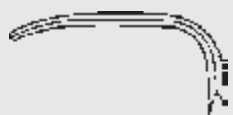

DO460R

25 x 7 mm



DO461R

31 x 10 mm



DO462R

42 x 11 mm

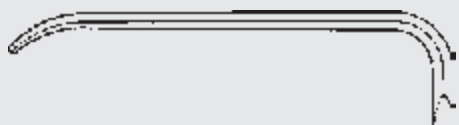

DO463R

55 x 12 mm

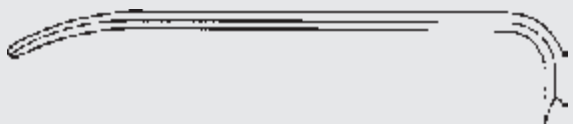

DO464R

70 x 14 mm



DO465R

80 x 16 mm

BT





Wundhaken – Wound Retractors

Wundhaken
Retractors

BT

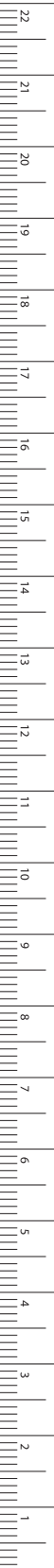

KOCHER

BT369R-BT373R

230 mm, 9"

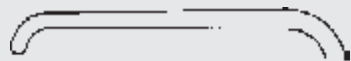

BT369R

40 x 18 mm

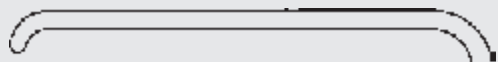

BT370R

60 x 20 mm



BT371R

60 x 25 mm

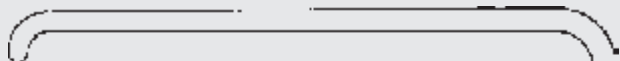

BT372R

75 x 30 mm



BT373R

75 x 40 mm

1/1

MILLIMETERS

Wundhaken – Wound Retractors

Wundhaken
Retractors

Maßangaben für Blattgrößen der Wundhaken

1. Zahl = Tiefe Beispiel: 25 x 38 mm

2. Zahl = Breite

Dimensions for blade size of retractors

1st number = depth Example: 25 x 38 mm

2nd number = width

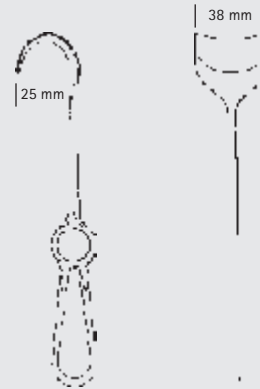

SAUERBRUCH

BT351R-BT353R

225 mm, 9"



BT351R

46 x 16 mm



BT352R

55 x 22 mm



BT353R

72 x 19 mm

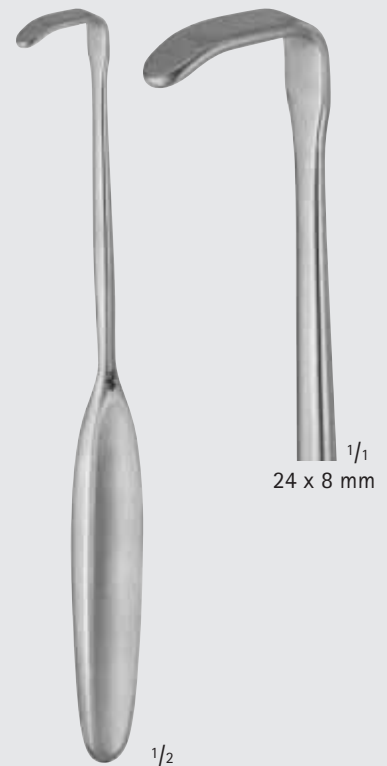

LAHEY

MB785R

200 mm, 8"

BT





Wundhaken – Wound Retractors

Wundhaken
Retractors

BT

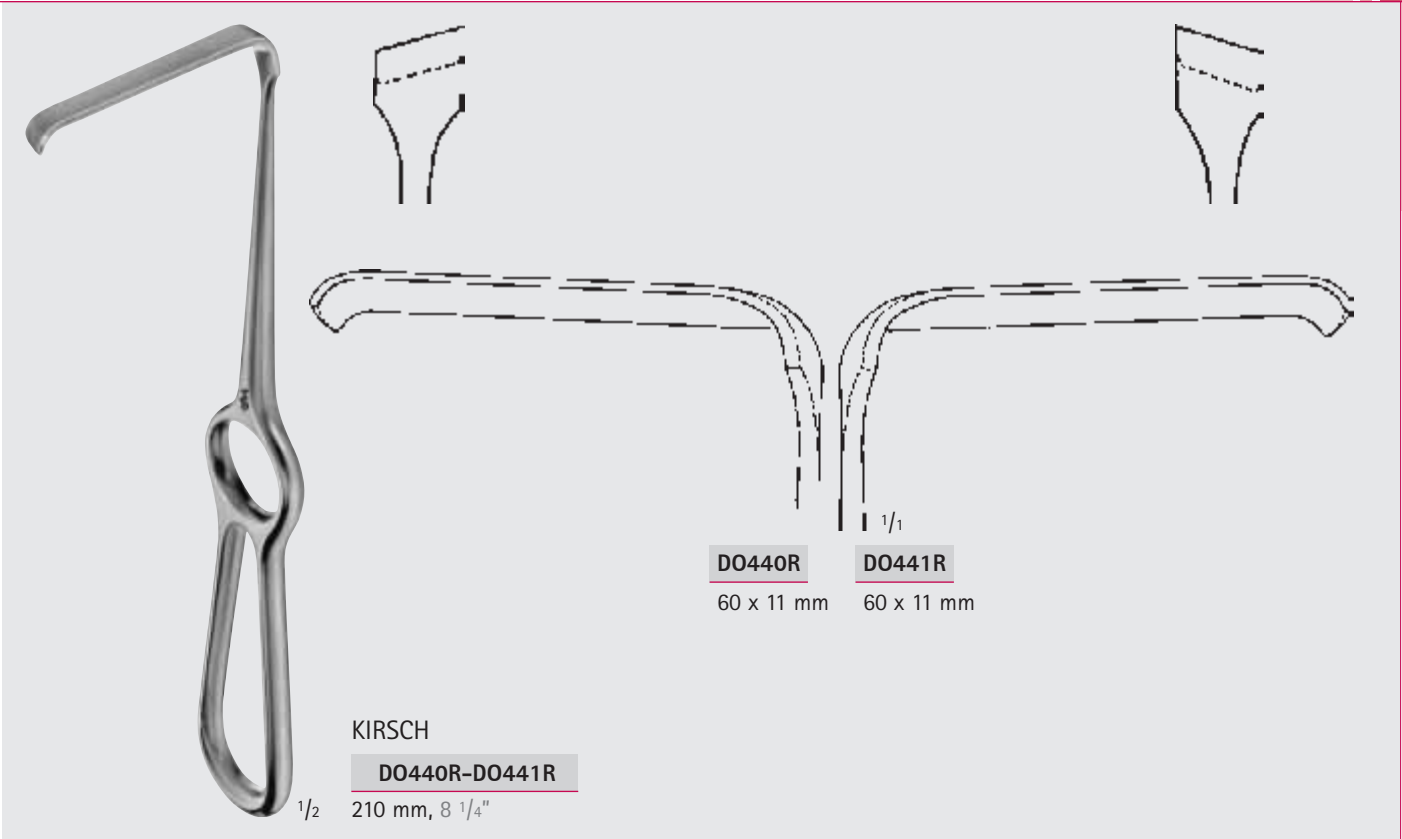

KIRSCH

DO440R-DO441R

$\frac{1}{2}$ 210 mm, 8 $\frac{1}{4}$ "

DO440R

60 x 11 mm

DO441R

60 x 11 mm

$\frac{1}{1}$



$\frac{1}{1}$
16 x 25 mm

$\frac{1}{2}$

DURHAM

BT400R

215 mm, 8 $\frac{1}{2}$ "

MILLIMETERS

Wundhaken – Wound Retractors

Wundhaken

Retractors

Maßangaben für Blattgrößen der Wundhaken

1. Zahl = Tiefe Beispiel: 25 x 38 mm

2. Zahl = Breite

Dimensions for blade size of retractors

1st number = depth Example: 25 x 38 mm

2nd number = width

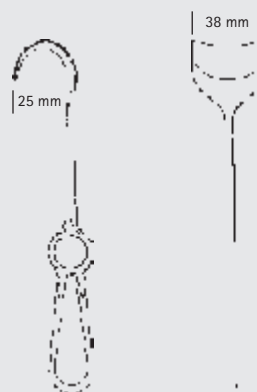

BT



BT404R

15 x 15 mm

220 mm

8 3/4"



1/1



BT405R

20 x 22 mm

215 mm

8 1/2"



BT406R

28 x 28 mm

235 mm

9 1/4"

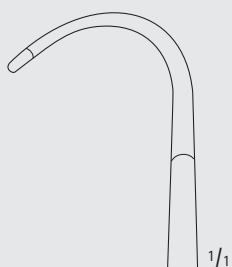

1/1



1/1



GREENE

BT408R

225 mm, 9"



22 x 22 mm



1/1

1/2

MIDDELDORPF

BT404R-BT406R



Wundhaken – Wound Retractors

Wundhaken
Retractors

BT



BÜCHS

DO432R

205 mm, 8"

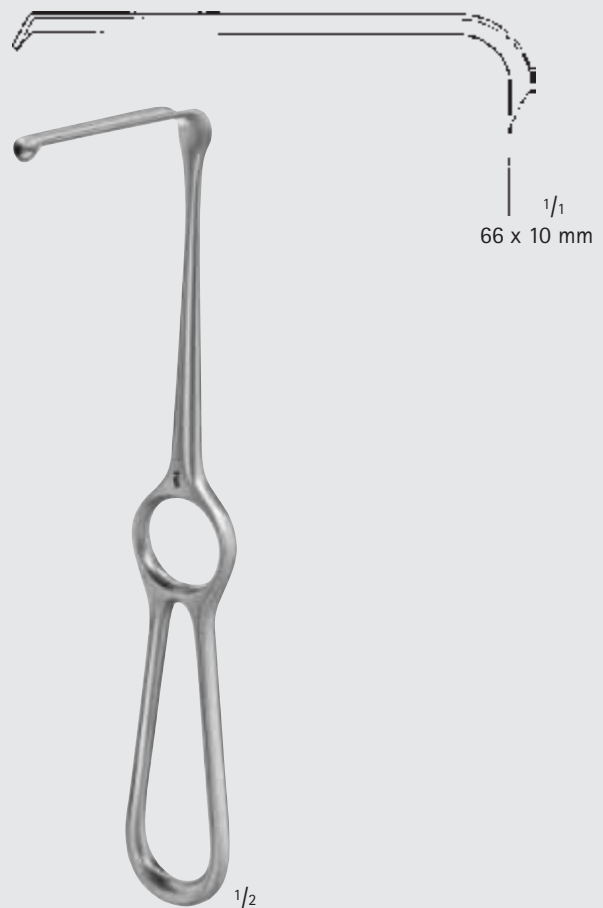

KRÄMER

BT464R

210 mm, 8 1/4"

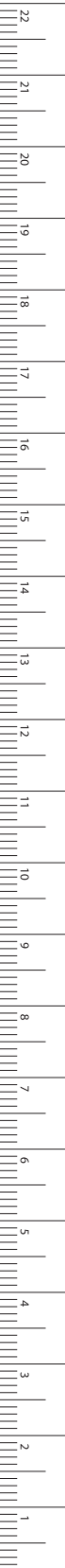

MILLIMETERS

Wundhaken – Wound Retractors

Wundhaken
Retractors

Maßangaben für Blattgrößen der Wundhaken

1. Zahl = Tiefe Beispiel: 25 x 38 mm

2. Zahl = Breite

Dimensions for blade size of retractors

1st number = depth Example: 25 x 38 mm

2nd number = width

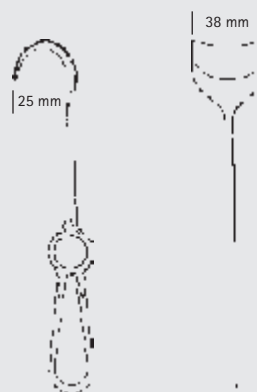

BT

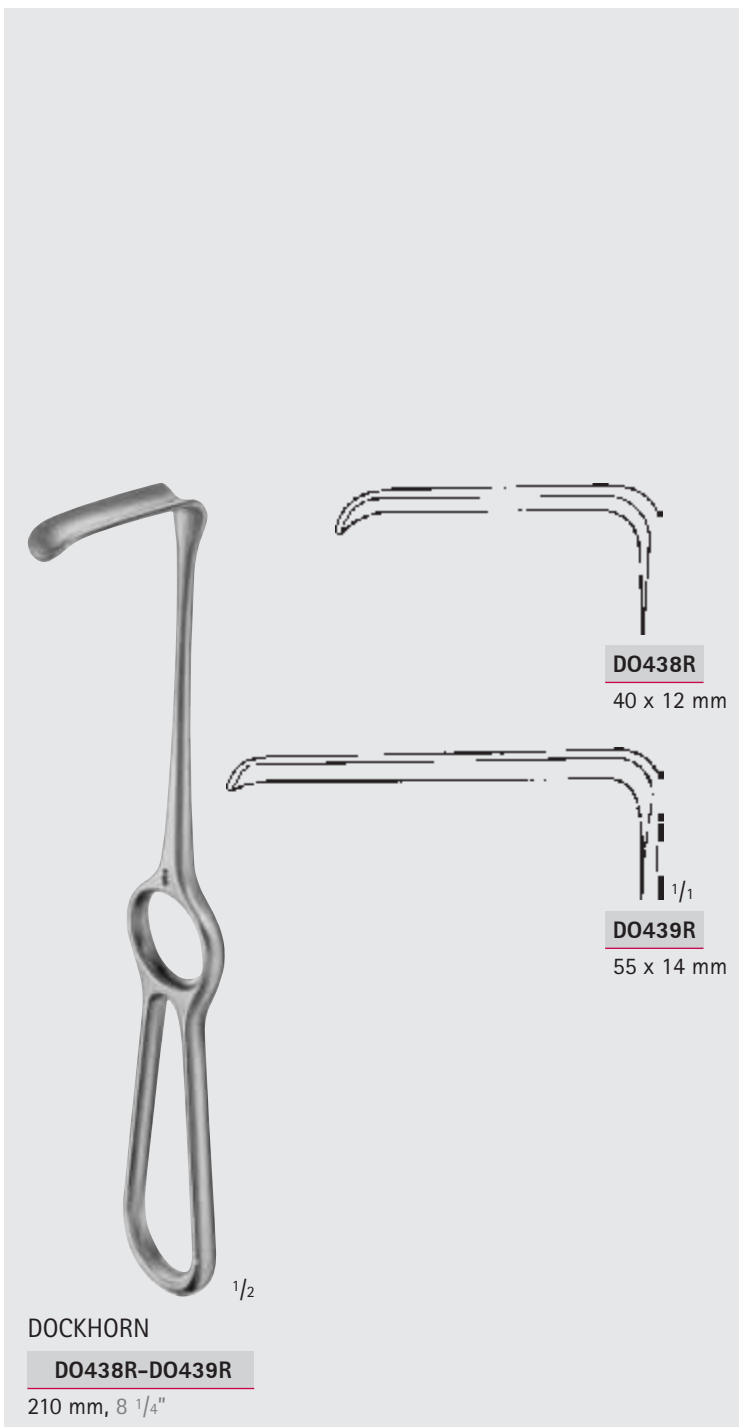



Wundhaken – Wound Retractors
Wundhaken
Retractors

BT

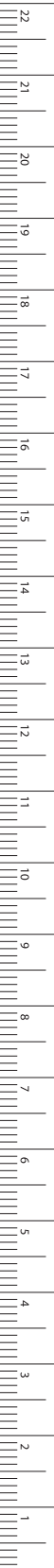

MILLIMETERS

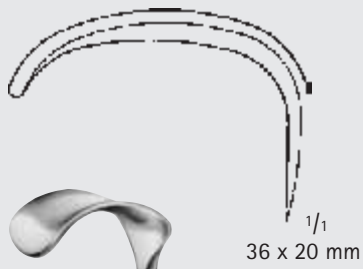

KOCHER

BT459R

230 mm, 9"

1/2

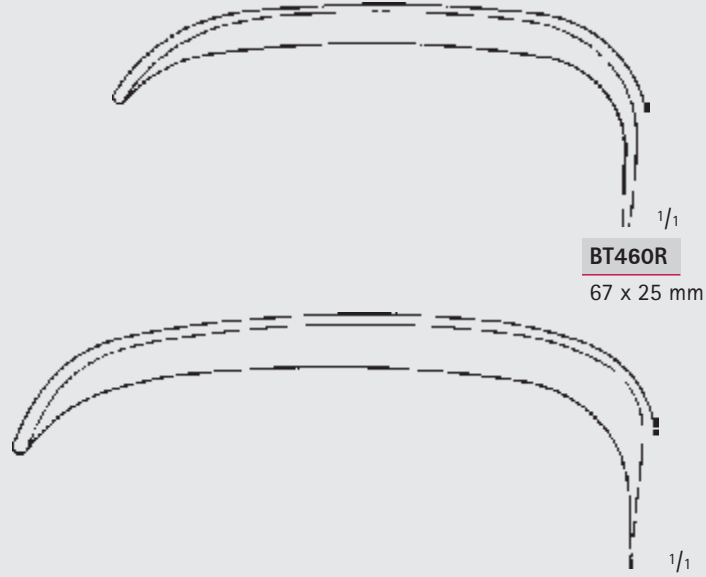

BT460R

67 x 25 mm

BT461R

80 x 42 mm

BT462R

80 x 50 mm

BT463R

80 x 60 mm



KOCHER

BT460R-BT463R

250 mm, 10"

1/2

Wundhaken – Wound Retractors

Wundhaken
Retractors

Maßangaben für Blattgrößen der Wundhaken

1. Zahl = Tiefe Beispiel: 25 x 38 mm

2. Zahl = Breite

Dimensions for blade size of retractors

1st number = depth Example: 25 x 38 mm

2nd number = width

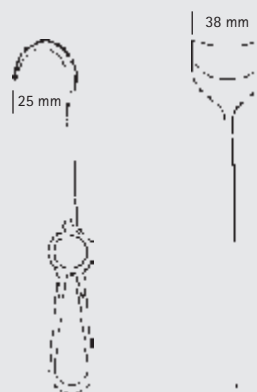

BT





Wundhaken – Wound Retractors

Wundhaken
Retractors

BT

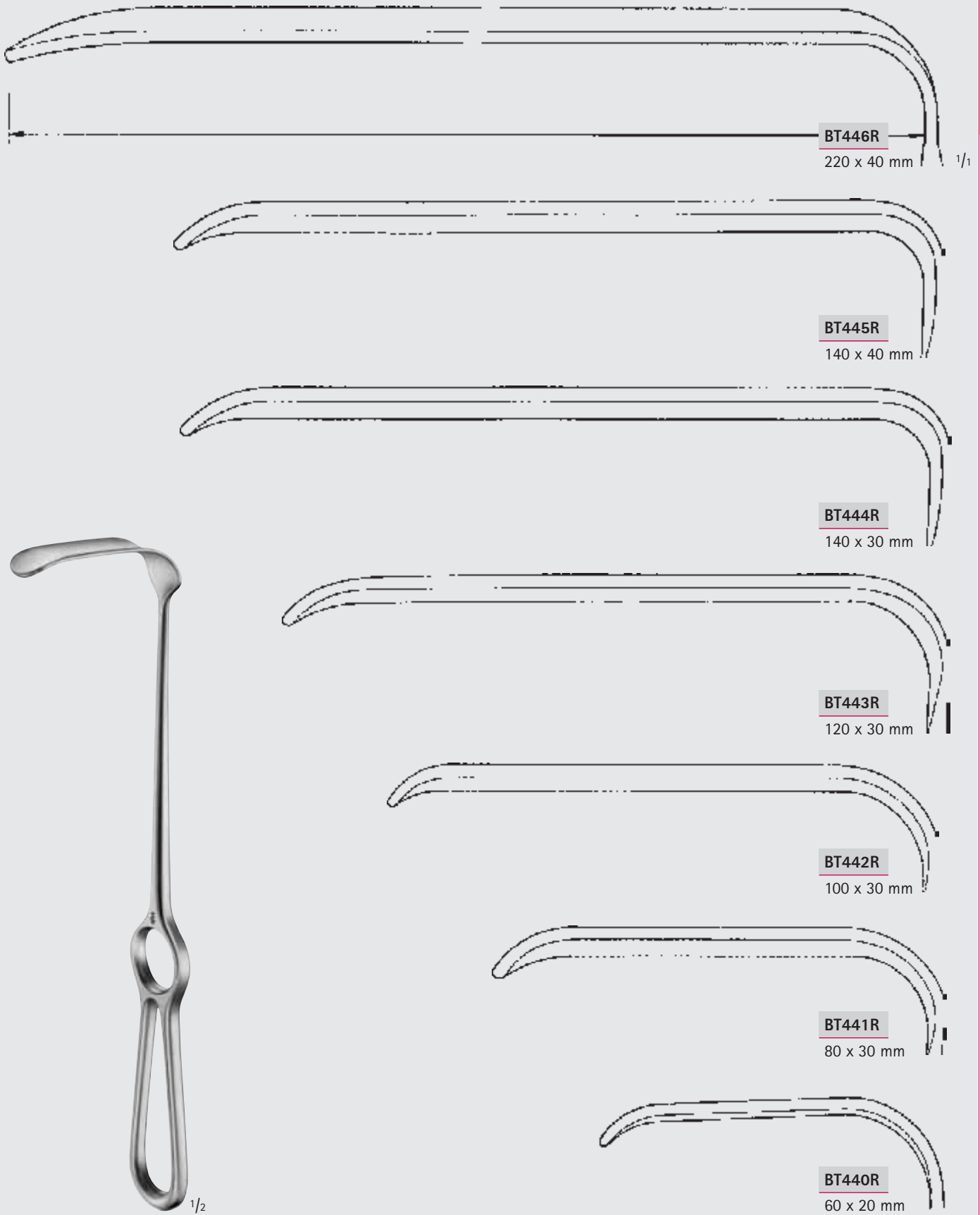

BT446R

220 x 40 mm

1/2

BT445R

140 x 40 mm

BT444R

140 x 30 mm

BT443R

120 x 30 mm

BT442R

100 x 30 mm

BT441R

80 x 30 mm

BT440R

60 x 20 mm



MILLIMETERS

HÖSEL

BT440R-BT446R

250 mm, 10"

1/2

Wundhaken – Wound Retractors

Wundhaken

Retractors

Maßangaben für Blattgrößen der Wundhaken

1. Zahl = Tiefe Beispiel: 25 x 38 mm

2. Zahl = Breite

Dimensions for blade size of retractors

1st number = depth Example: 25 x 38 mm

2nd number = width

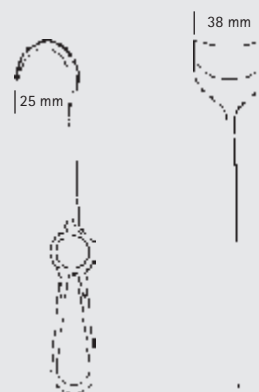

BT540P

60 x 40 mm

BT542P

100 x 40 mm

BT545P

140 x 40 mm

Wundhaken

- Aus kohlefaserverstärktem Polymer
- Röntgendurchlässig
- Blendfrei
- Autoklavierbar 134°C/ 2 bar
- Hohe Stabilität
- Federleicht - bis zu 65% Gewichtsersparnis zu einem vergleichbaren Stahlhaken

Retractor

- Made from a carbon fibre reinforced polymer
- X-ray translucent
- Non-glare finish
- Autoclavable 134°C / 2 bar
- High stability
- Feather light - up to 65% weight reduction compared to an equivalent stainless steel retractor

BT540P-BT545P

255 mm, 10"

INCHES



Wundhaken – Wound Retractors

Wundhaken
Retractors

BT

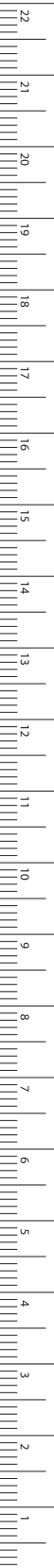

MILLIMETERS



RICHARDSON-EASTMAN

BT470R

Satz komplett,
bestehend aus:

Set complete,
consisting of:

BT471R
BT472R

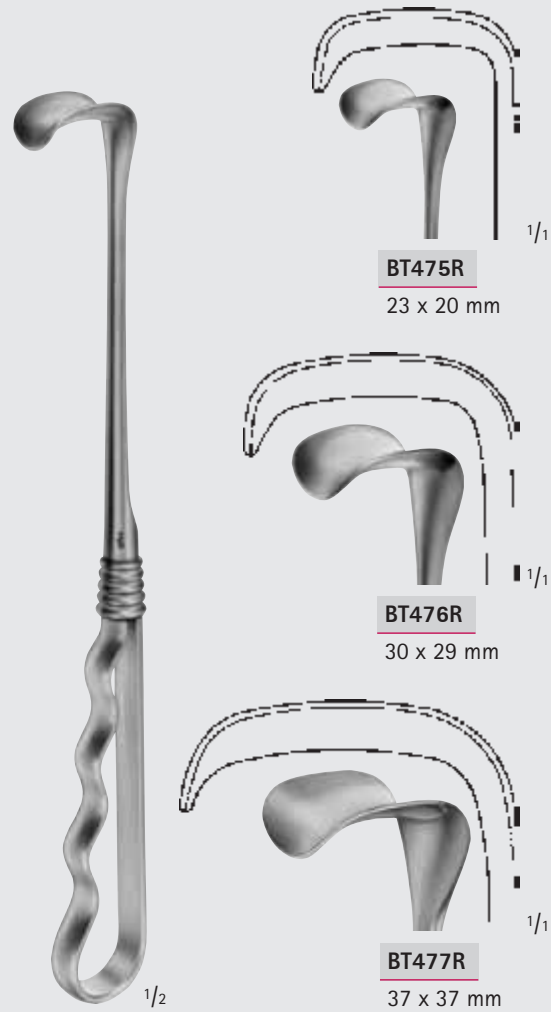

RICHARDSON

BT475R-BT477R

240 mm, 9 1/2"

Wundhaken – Wound Retractors

Wundhaken
Retractors

Maßangaben für Blattgrößen der Wundhaken

1. Zahl = Tiefe Beispiel: 25 x 38 mm

2. Zahl = Breite

Dimensions for blade size of retractors

1st number = depth Example: 25 x 38 mm

2nd number = width

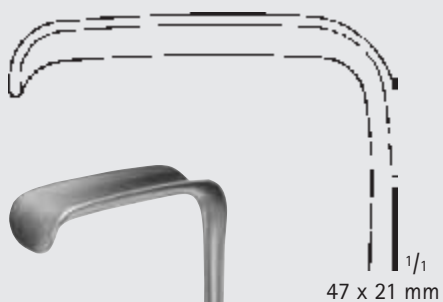
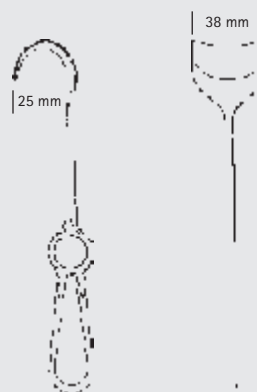

47 x 21 mm $\frac{1}{1}$



RICHARDSON

BT478R

240 mm, 9 1/2"



65 x 41 mm $\frac{1}{1}$



RICHARDSON

BT479R

250 mm, 10"





Wundhaken – Wound Retractors
Wundhaken
Retractors

BT

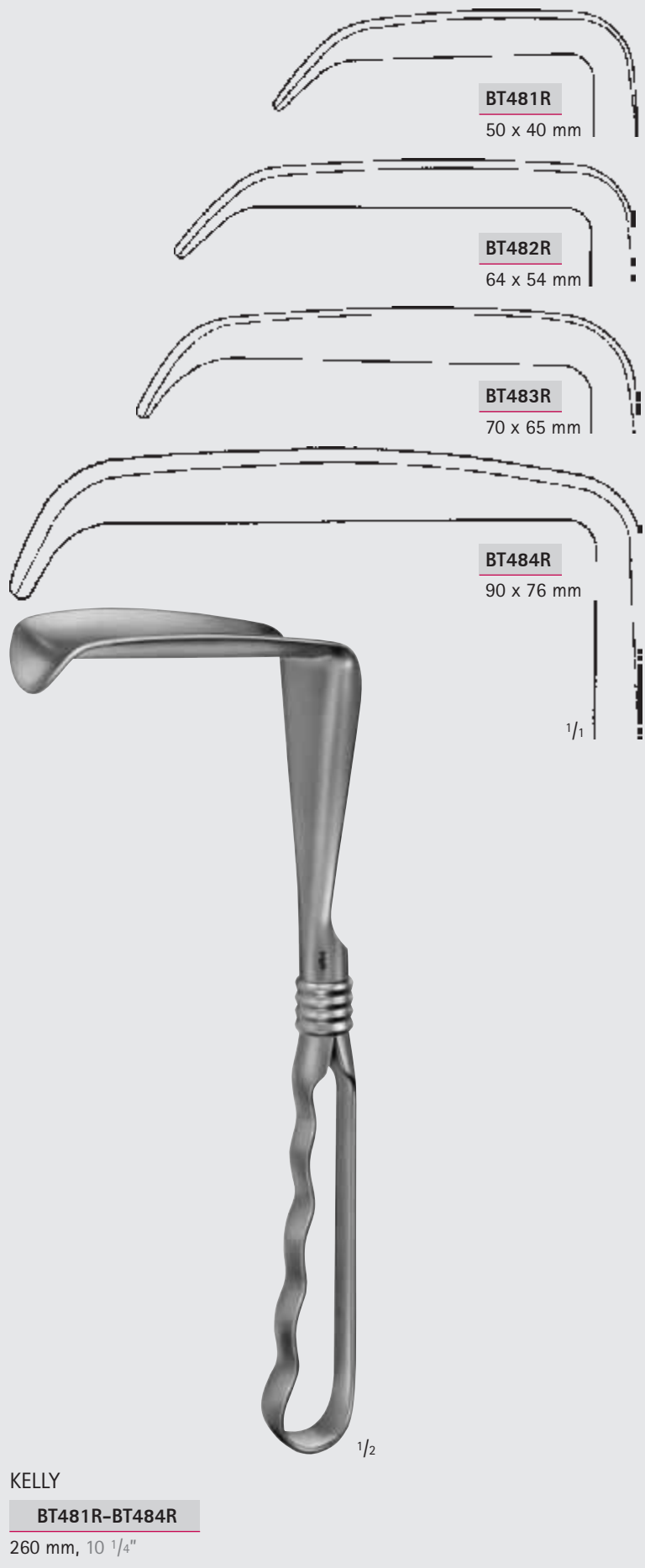

Wundhaken – Wound Retractors

Wundhaken
Retractors

Maßangaben für Blattgrößen der Wundhaken

1. Zahl = Tiefe Beispiel: 25 x 38 mm

2. Zahl = Breite

Dimensions for blade size of retractors

1st number = depth Example: 25 x 38 mm

2nd number = width

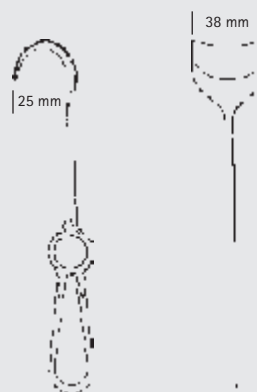

MEYERDING

BT485R-BT487R

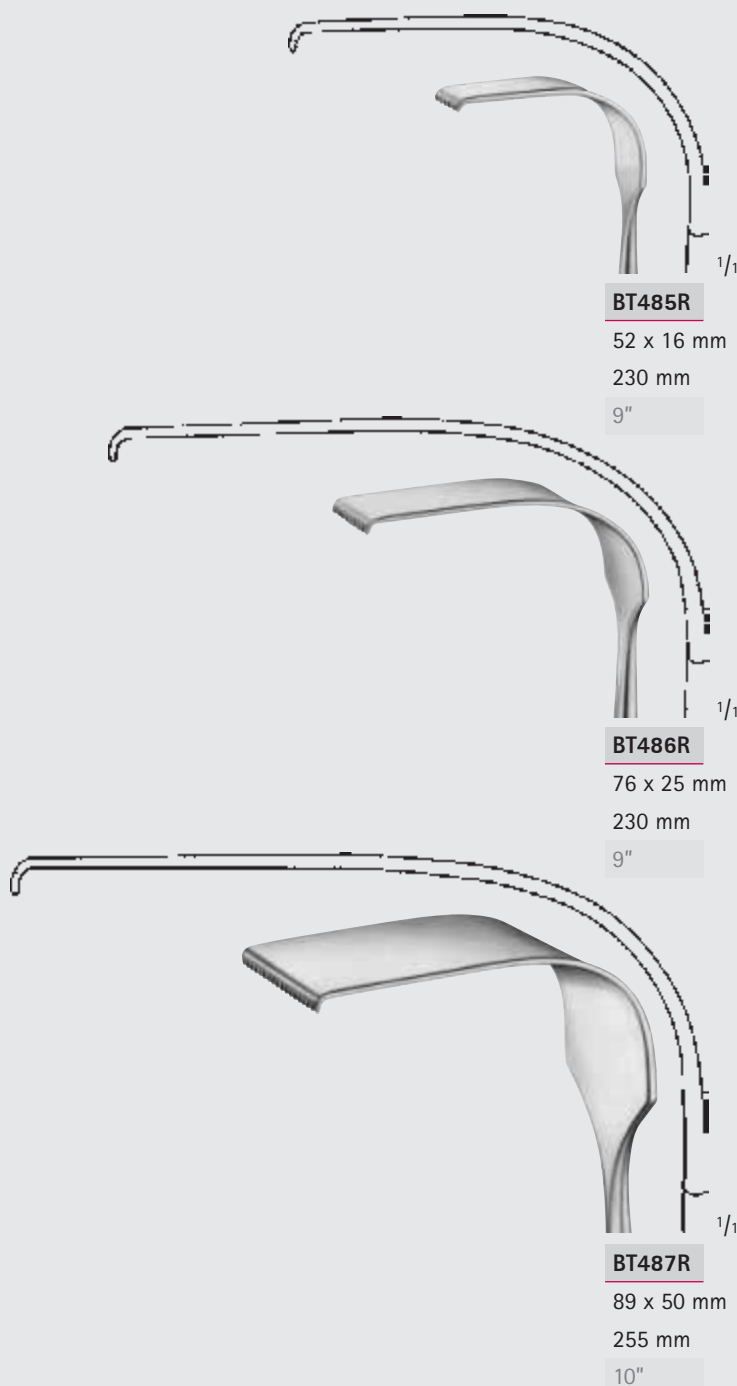

BT





Wundhaken – Wound Retractors
Wundhaken
Retractors

BT



Wundhaken – Wound Retractors

Wundhaken
Retractors

Maßangaben für Blattgrößen der Wundhaken

1. Zahl = Tiefe Beispiel: 25 x 38 mm

2. Zahl = Breite

Dimensions for blade size of retractors

1st number = depth Example: 25 x 38 mm

2nd number = width

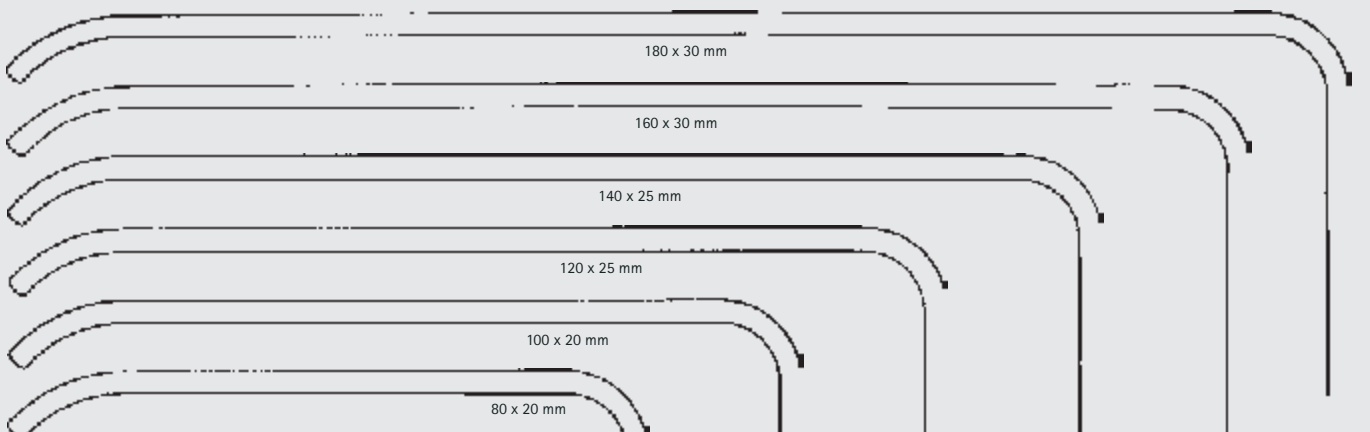
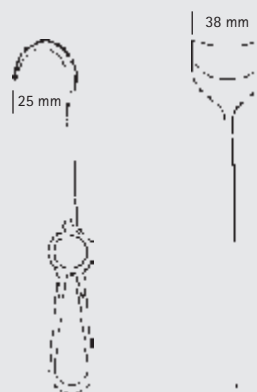

- BT508R
- BT509R
- BT510R
- BT511R
- BT512R
- BT513R

BRUNNER

BT508R-BT513R

¹/₂ 250 mm, 10"

BT





Wundhaken – Wound Retractors

Wundhaken
Retractors

BT

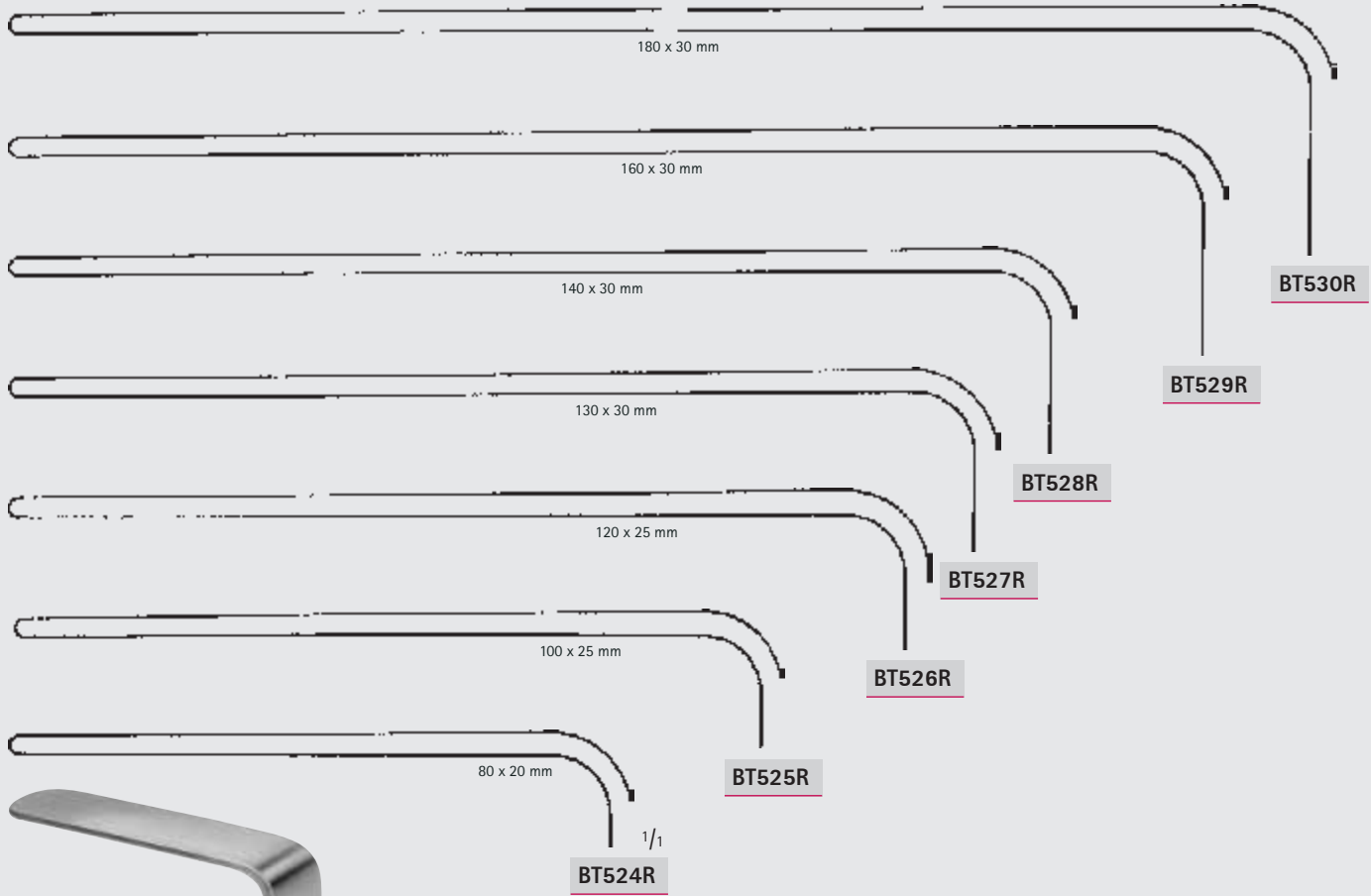

BRUNNER

BT524R-BT530R

$\frac{1}{2}$ 275 mm, 10 $\frac{3}{4}$ "

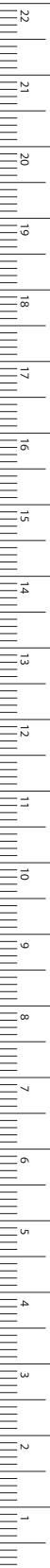

MILLIMETERS

Wundhaken – Wound Retractors

Varion-Wundhaken-System, DBP

Vario Retractor System, Germ. Fed. Patent

BT

Maßangaben für Blattgrößen der Wundhaken

1. Zahl = Tiefe Beispiel: 25 x 38 mm

2. Zahl = Breite

Dimensions for blade size of retractors

1st number = depth Example: 25 x 38 mm

2nd number = width

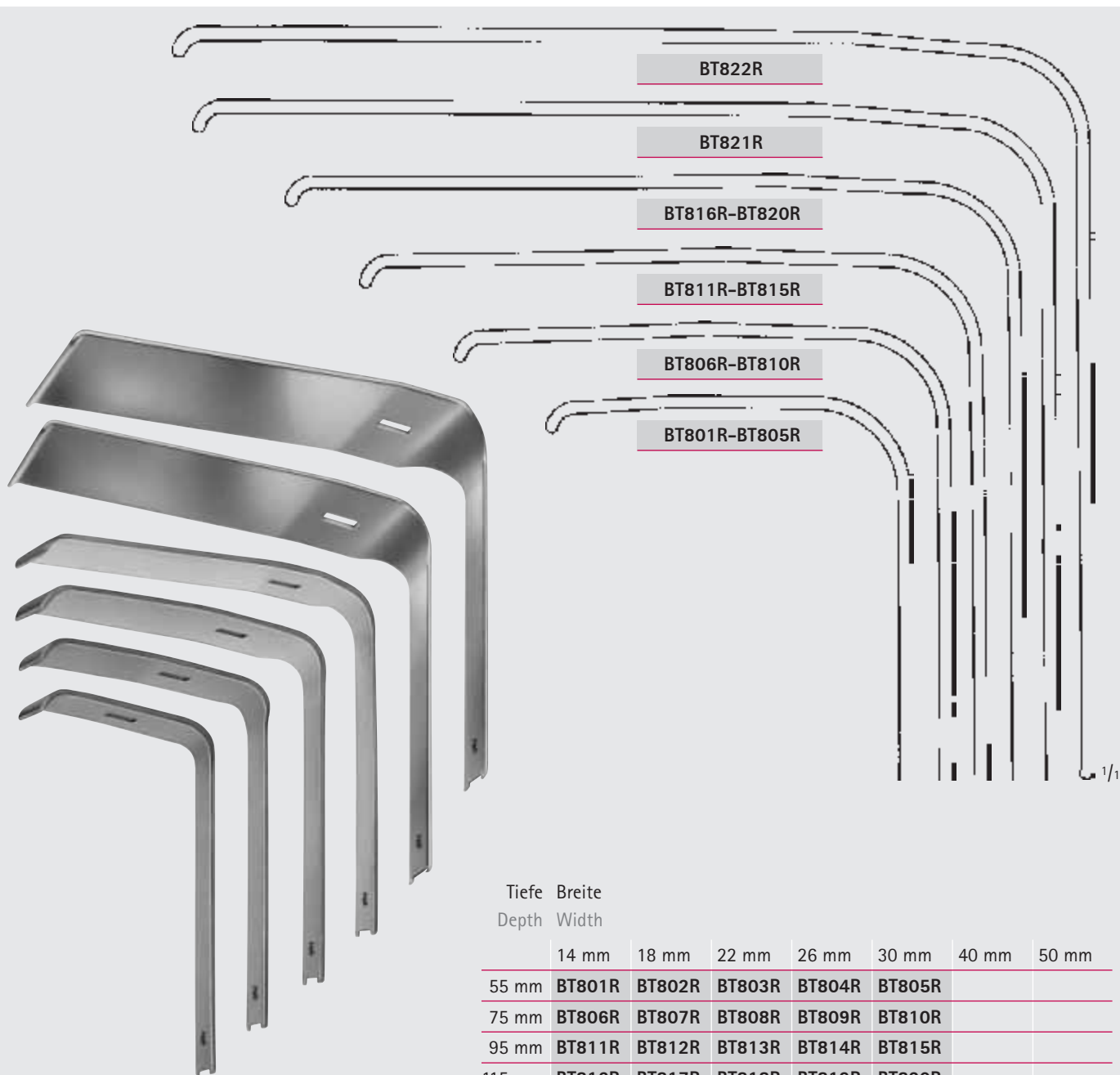
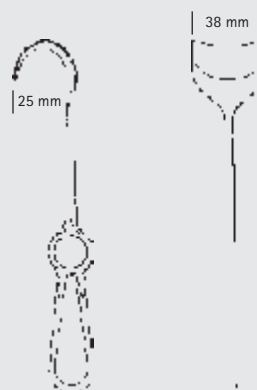

Tiefe Depth	Breite Width						
	14 mm	18 mm	22 mm	26 mm	30 mm	40 mm	50 mm
55 mm	BT801R	BT802R	BT803R	BT804R	BT805R		
75 mm	BT806R	BT807R	BT808R	BT809R	BT810R		
95 mm	BT811R	BT812R	BT813R	BT814R	BT815R		
115 mm	BT816R	BT817R	BT818R	BT819R	BT820R		
135 mm						BT821R	
145 mm							BT822R

Wundhakenblätter
passend auf die Handgriffe
BT799R und BT800R.

Retractor blades
for handles
BT799R and BT800R.



Wundhaken – Wound Retractors

Varion-Wundhaken-System, DBP
Vario Retractor System, Germ. Fed. Patent

Varion-Wundhaken-System mit integriertem Kaltlicht, zur zusätzlichen, intensiven Ausleuchtung des Operationsfeldes, speziell bei komplizierten, in die Tiefe gehenden Eingriffen.

Zu verwenden mit Aesculap Lichtquellen.

Vario retractor system with integrated cold light, for additional intensive illumination of deep and complicated operation fields.

To be used with Aesculap light sources.



Griffstellung variabel
Handle arrangement variable

BT800R

Handgriff mit Kaltlichtleiter,
zur Aufnahme von
Wundhakenblätter
Handle with cold light carrier
for retractor blades
280 mm, 11"

BT799R

Handgriff mit Kaltlichtleiter,
zur Aufnahme von
Wundhakenblättern
Handle with cold light carrier
for retractor blades
180 mm, 7"

BT



MILLIMETERS

Wundhaken – Wound Retractors

Wundhaken, Lungenspatel

Retractors, Lung Spatulas

Maßangaben für Blattgrößen der Wundhaken

1. Zahl = Tiefe Beispiel: 25 x 38 mm

2. Zahl = Breite

Dimensions for blade size of retractors

1st number = depth Example: 25 x 38 mm

2nd number = width

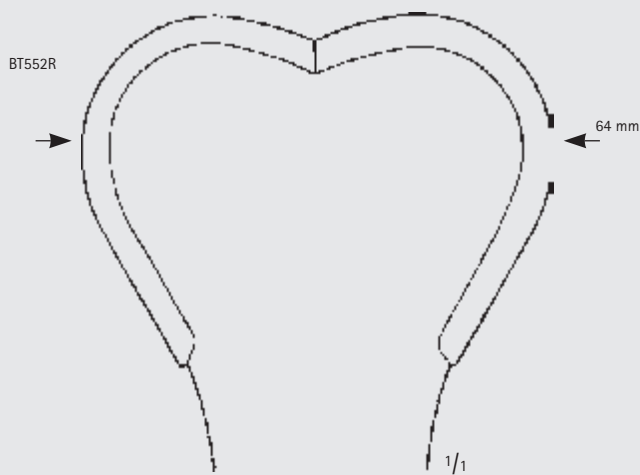
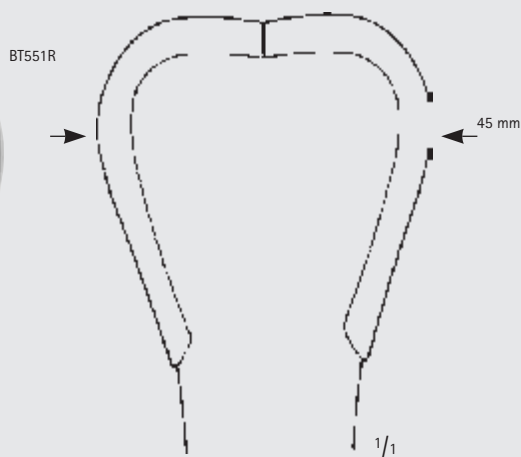
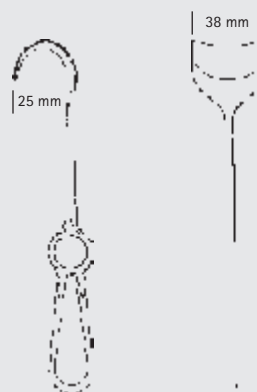

HARRINGTON

BT551R 123 x 45 mm

BT552R 123 x 64 mm

federnd

flexible

295 mm, 11 3/4"



Wundhaken – Wound Retractors

Wundhaken, Lungenspatel
Retractors, Lung Spatulas

BT

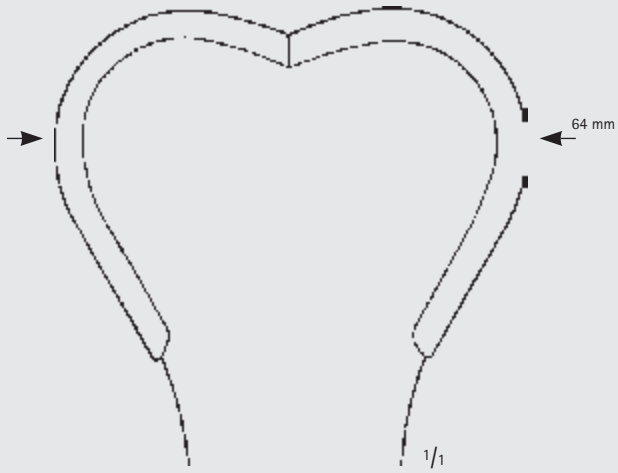

HARRINGTON-PEMBERTON

BT553R

175 x 64 mm

federnd

flexible

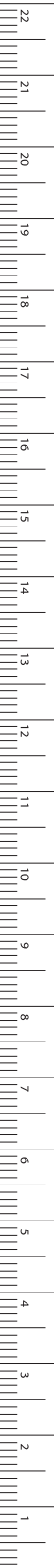

MILLIMETERS

Wundhaken – Wound Retractors

Lungenspatel

Lung Spatulas

BT

Maßangaben für Blattgrößen der Wundhaken

1. Zahl = Tiefe Beispiel: 25 x 38 mm

2. Zahl = Breite

Dimensions for blade size of retractors

1st number = depth Example: 25 x 38 mm

2nd number = width

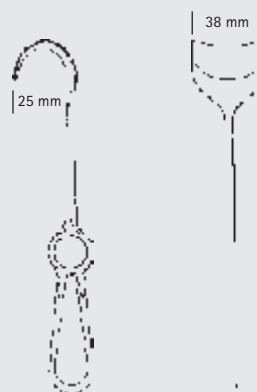

ALLISON

BT559R

255 mm, 10"



ALLISON

BT560R

320 mm, 12 3/4"

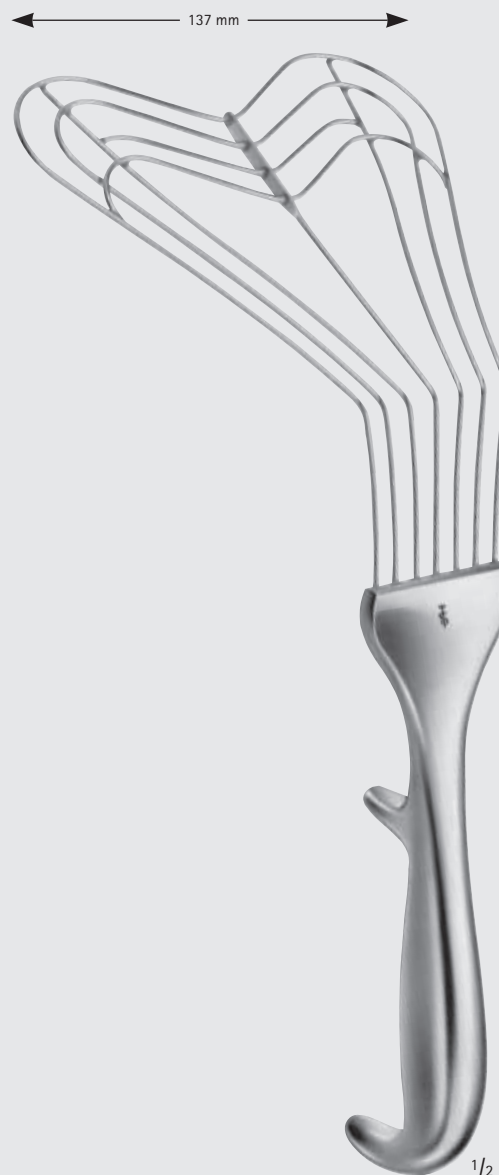

ALLISON

BT561R

300 mm, 12"





Wundhaken – Wound Retractors

Wundhaken, Lungenspatel
Retractors, Lung Spatulas

BT

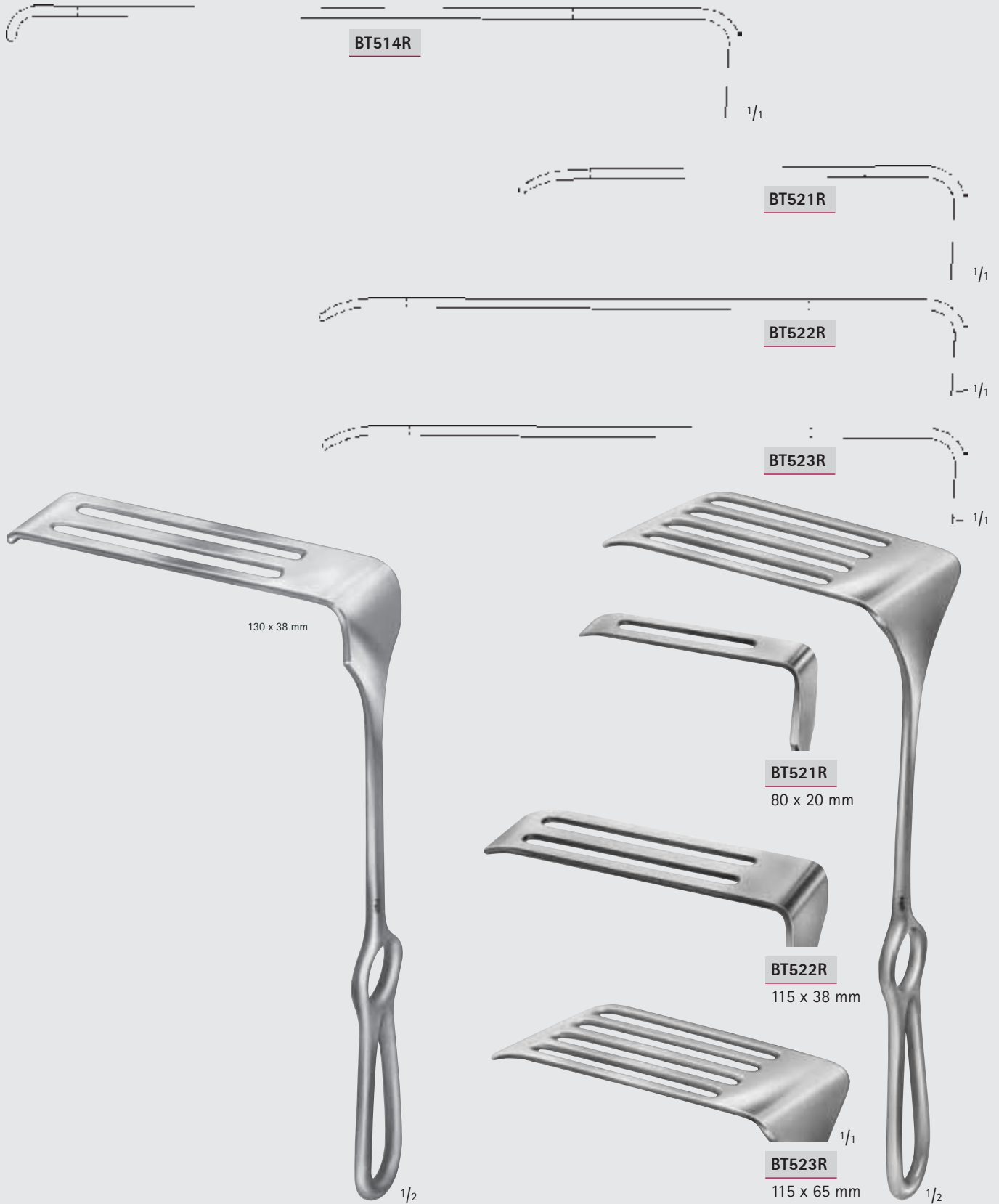

SAUERBRUCH

BT514R

260 mm, 10 1/4"

CORYLLOS

BT521R-BT523R

255 mm, 10"

MILLIMETERS

Wundhaken – Wound Retractors

Scapula Haken

Scapula Retractor

Maßangaben für Blattgrößen der Wundhaken

1. Zahl = Tiefe Beispiel: 25 x 38 mm

2. Zahl = Breite

Dimensions for blade size of retractors

1st number = depth Example: 25 x 38 mm

2nd number = width

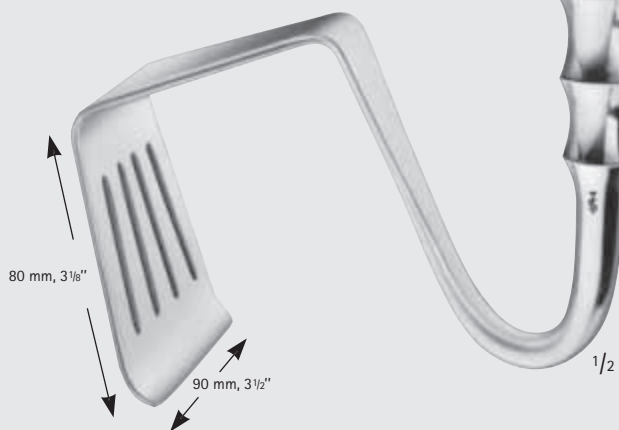
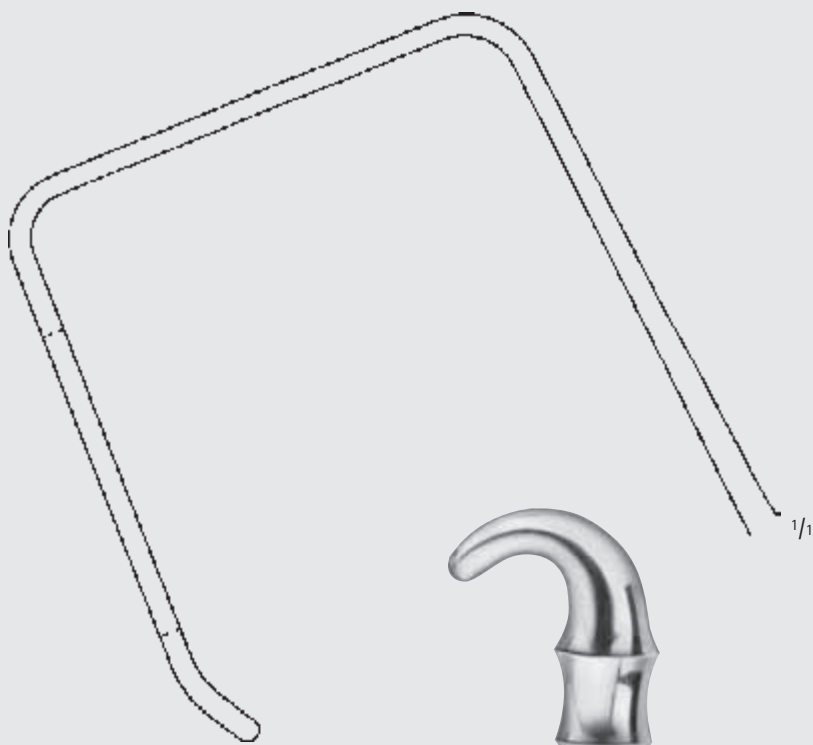
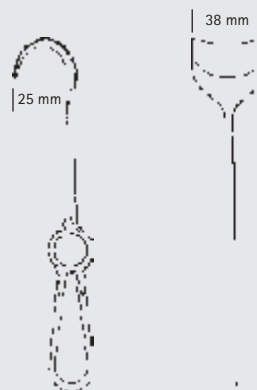

DAVIDSON

BT531R

195 mm, 7 3/4\"/>

BT





Wundhaken – Wound Retractors
Wundhaken
Retractors

BT



Wundhaken – Wound Retractors

Wundhaken
Retractors

Maßangaben für Blattgrößen der Wundhaken

1. Zahl = Tiefe Beispiel: 25 x 38 mm

2. Zahl = Breite

Dimensions for blade size of retractors

1st number = depth Example: 25 x 38 mm

2nd number = width

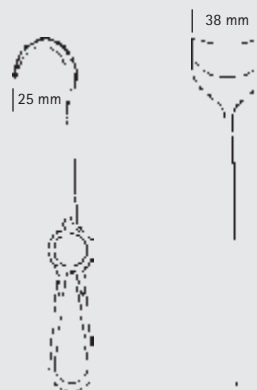

MD076

10 mm

160 mm

6 1/4"

1/2

MD077

13 mm

180 mm

7"

1/2

HASSON

MD076-MD077

BT





Wundhaken – Wound Retractors

Wundhaken
Retractors

BT

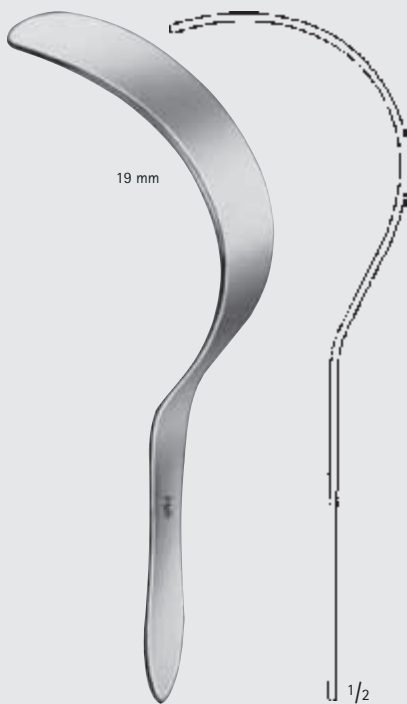

DEAVER

BT600R

180 mm, 7"
Fig. 000

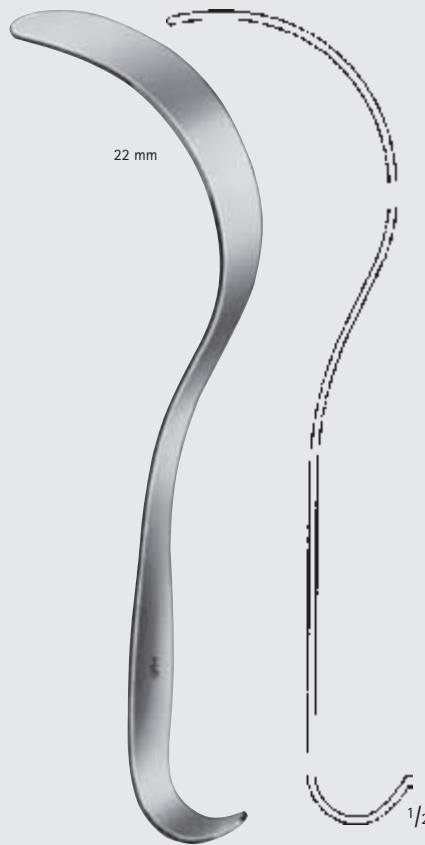

DEAVER

BT601R

215 mm, 8 1/2"
Fig. 00

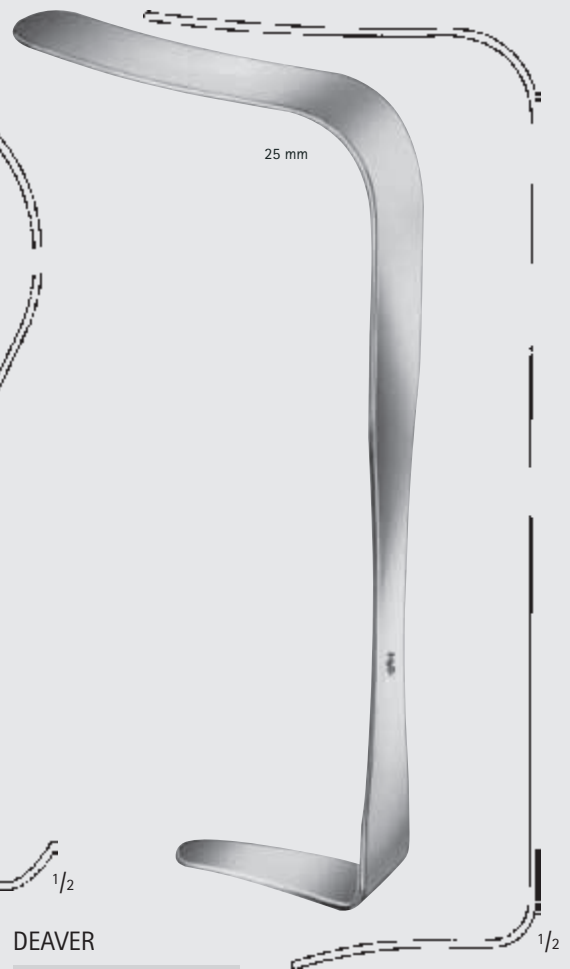

DEAVER

BT606R

235 mm, 9 1/4"
Fig. 0

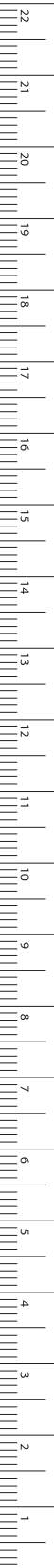

MILLIMETERS

Wundhaken – Wound Retractors

Wundhaken
Retractors

Maßangaben für Blattgrößen der Wundhaken

1. Zahl = Tiefe Beispiel: 25 x 38 mm

2. Zahl = Breite

Dimensions for blade size of retractors

1st number = depth Example: 25 x 38 mm

2nd number = width

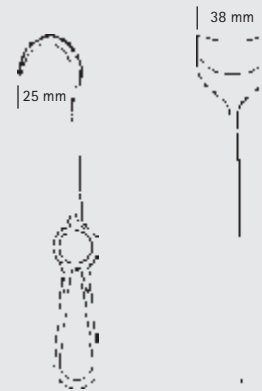

DEAVER

BT602R

Fig. 1
300 mm, 12"

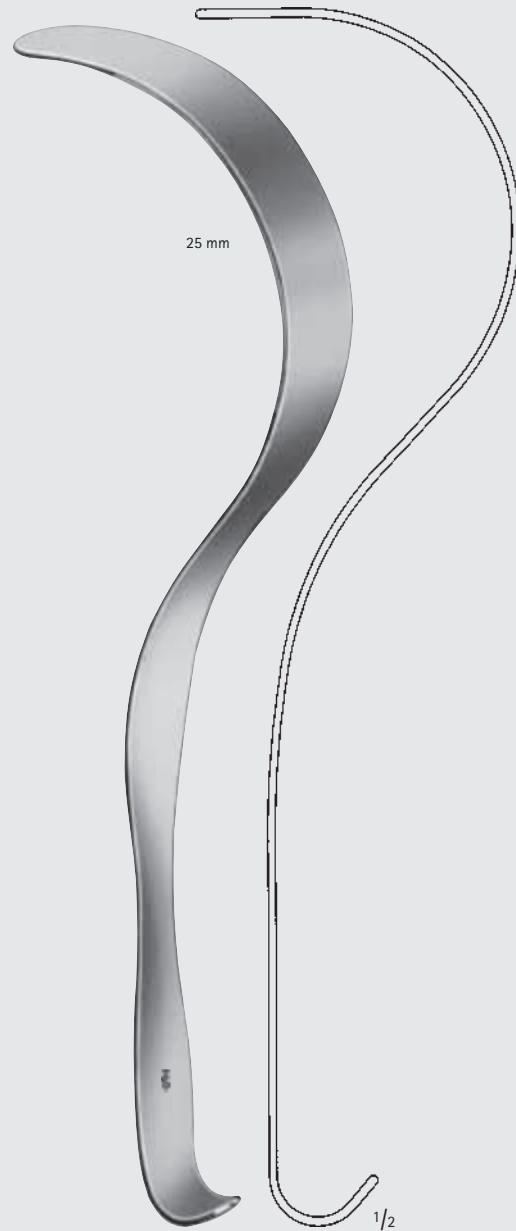

DEAVER

BT603R

Fig. 2
315 mm, 12 1/2"

BT





Wundhaken – Wound Retractors

Wundhaken
Retractors

BT



DEAVER

BT607R

Fig. 2 1/2
365 mm, 14 1/2"



DEAVER

BT604R

Fig. 3
300 mm, 12"

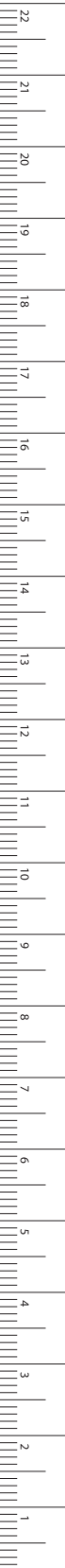

Wundhaken – Wound Retractors

Wundhaken
Retractors

Maßangaben für Blattgrößen der Wundhaken

1. Zahl = Tiefe Beispiel: 25 x 38 mm

2. Zahl = Breite

Dimensions for blade size of retractors

1st number = depth Example: 25 x 38 mm

2nd number = width

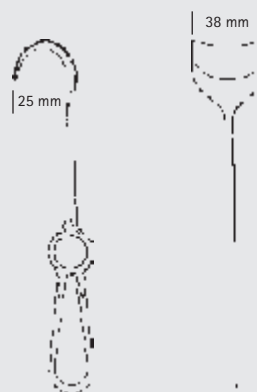

DEAVER

BT605R

Fig. 4

310 mm, 12 1/4"

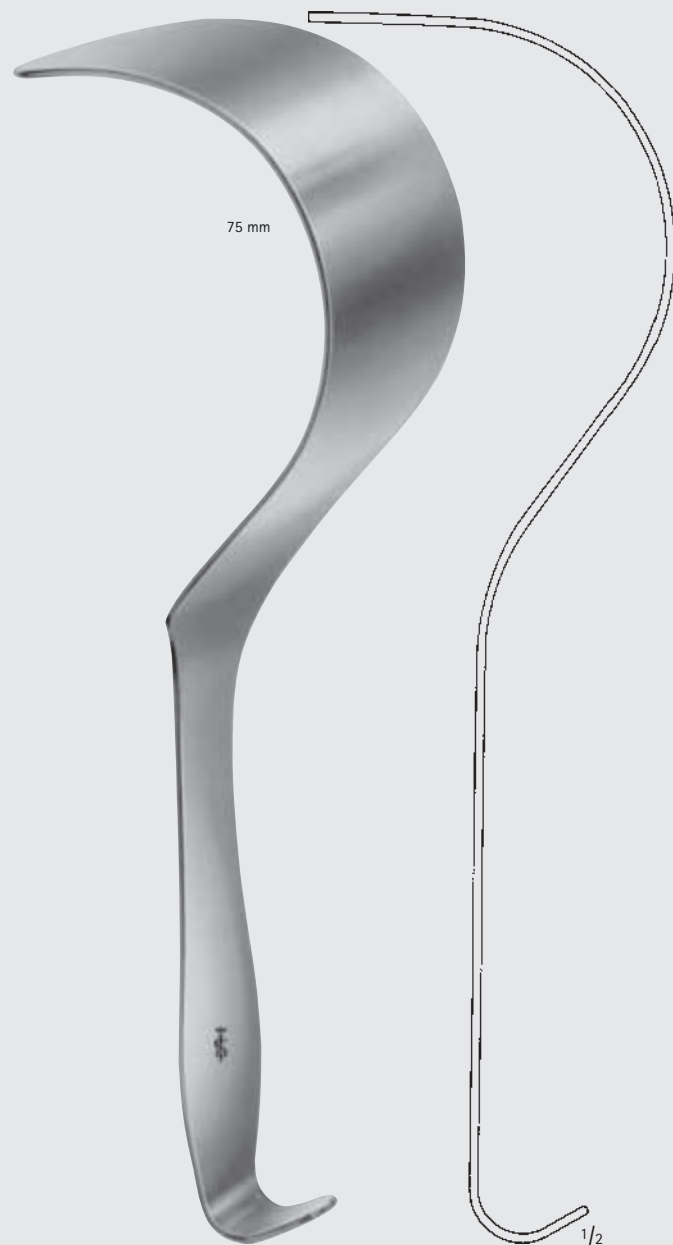

DEAVER

BT608R

Fig. 5

320 mm, 12 3/4"

BT





Wundhaken – Wound Retractors

Wundhaken
Retractors

BT



DEAVER

BT611R

Fig. 1
310 mm, 12 1/4"



DEAVER

BT613R

Fig. 3
310 mm, 12 1/4"

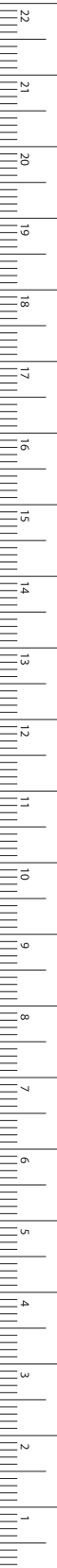

Wundhaken – Wound Retractors

Wundhaken
Retractors

Maßangaben für Blattgrößen der Wundhaken

1. Zahl = Tiefe Beispiel: 25 x 38 mm

2. Zahl = Breite

Dimensions for blade size of retractors

1st number = depth Example: 25 x 38 mm

2nd number = width

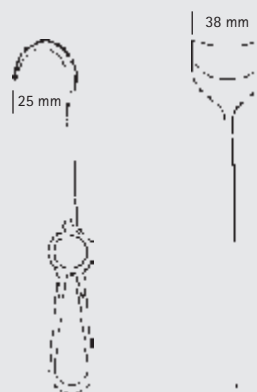

DEAVER

BT614R

Fig. 4
305 mm, 12"



DEAVER

BT615R

Fig. 5
310 mm, 12 1/4"

BT





Wundhaken – Wound Retractors

Wundhaken
Retractors

BT

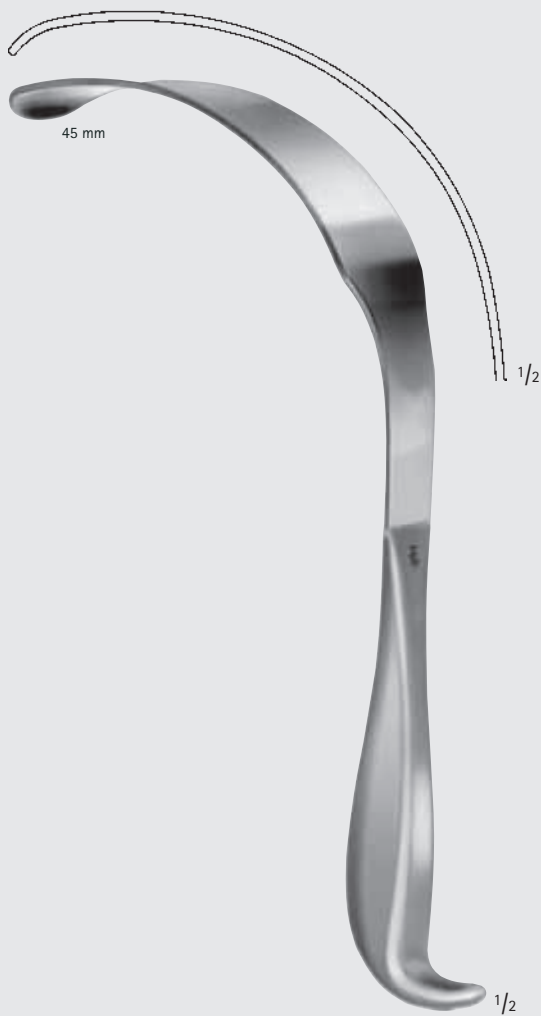

LERICHE

BT730R

255 mm, 10"



LERICHE

BT732R

275 mm, 10 3/4"

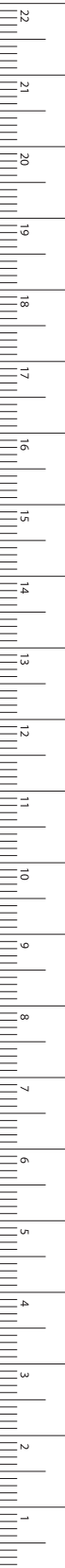

MILLIMETERS

Wundhaken – Wound Retractors

Wundhaken
Retractors

Maßangaben für Blattgrößen der Wundhaken

1. Zahl = Tiefe Beispiel: 25 x 38 mm

2. Zahl = Breite

Dimensions for blade size of retractors

1st number = depth Example: 25 x 38 mm

2nd number = width

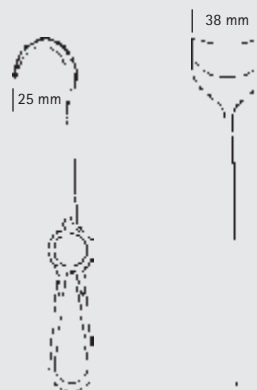

KÜMMEL

BT740R

biegsam

malleable

285 mm, 11 1/4"

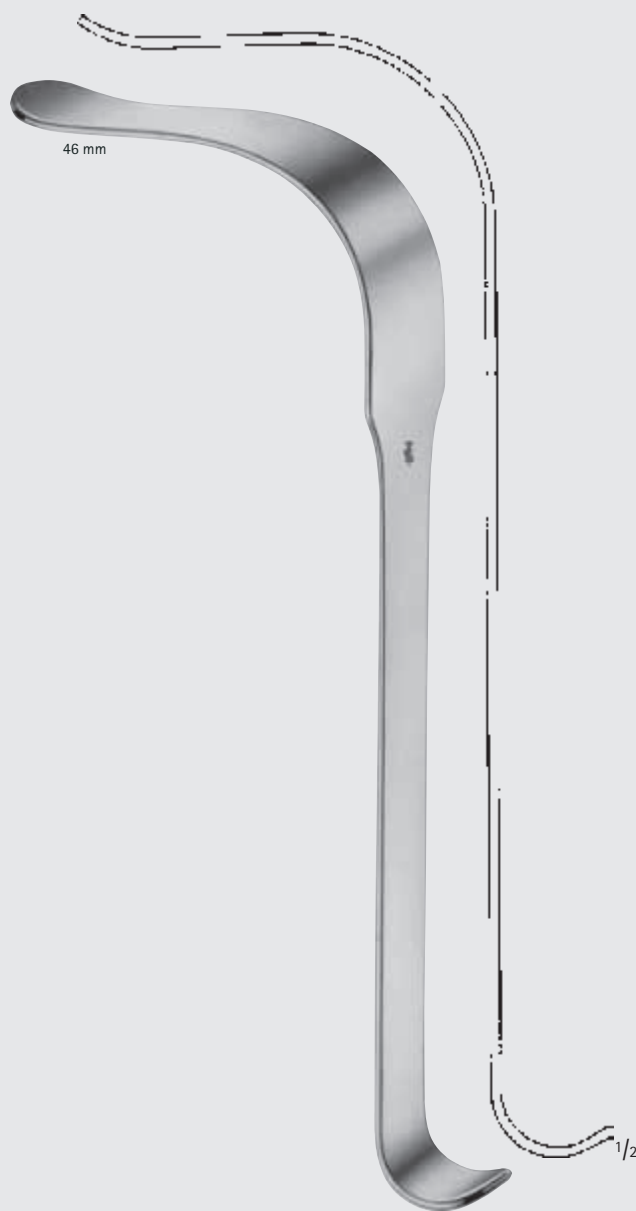

KÖRTE

BT742R

300 mm, 12"

BT





Wundhaken – Wound Retractors

Wundhaken für Eingriffe in der Tiefe (Bauchdeckenhaken)
Retractors for Deep Surgery (Abdominal Retractors)

BT

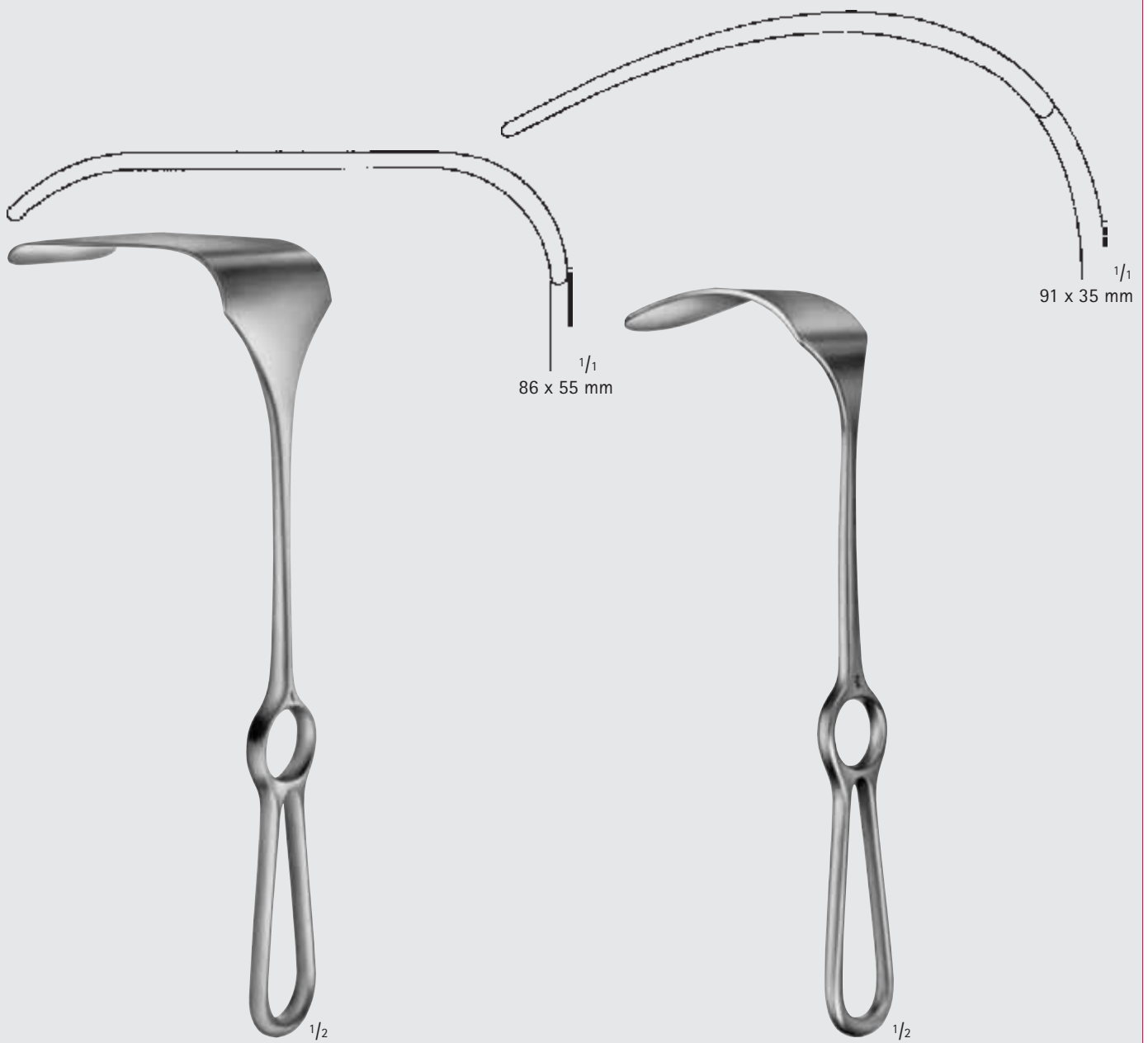

MIKULICZ

BT618R

255 mm, 10"

MIKULICZ

BT621R

240 mm, 9 1/2"

MILLIMETERS

Wundhaken – Wound Retractors

Wundhaken für Eingriffe in der Tiefe (Bauchdeckenhaken)

Retractors for Deep Surgery (Abdominal Retractors)

Maßangaben für Blattgrößen der Wundhaken

1. Zahl = Tiefe Beispiel: 25 x 38 mm

2. Zahl = Breite

Dimensions for blade size of retractors

1st number = depth Example: 25 x 38 mm

2nd number = width

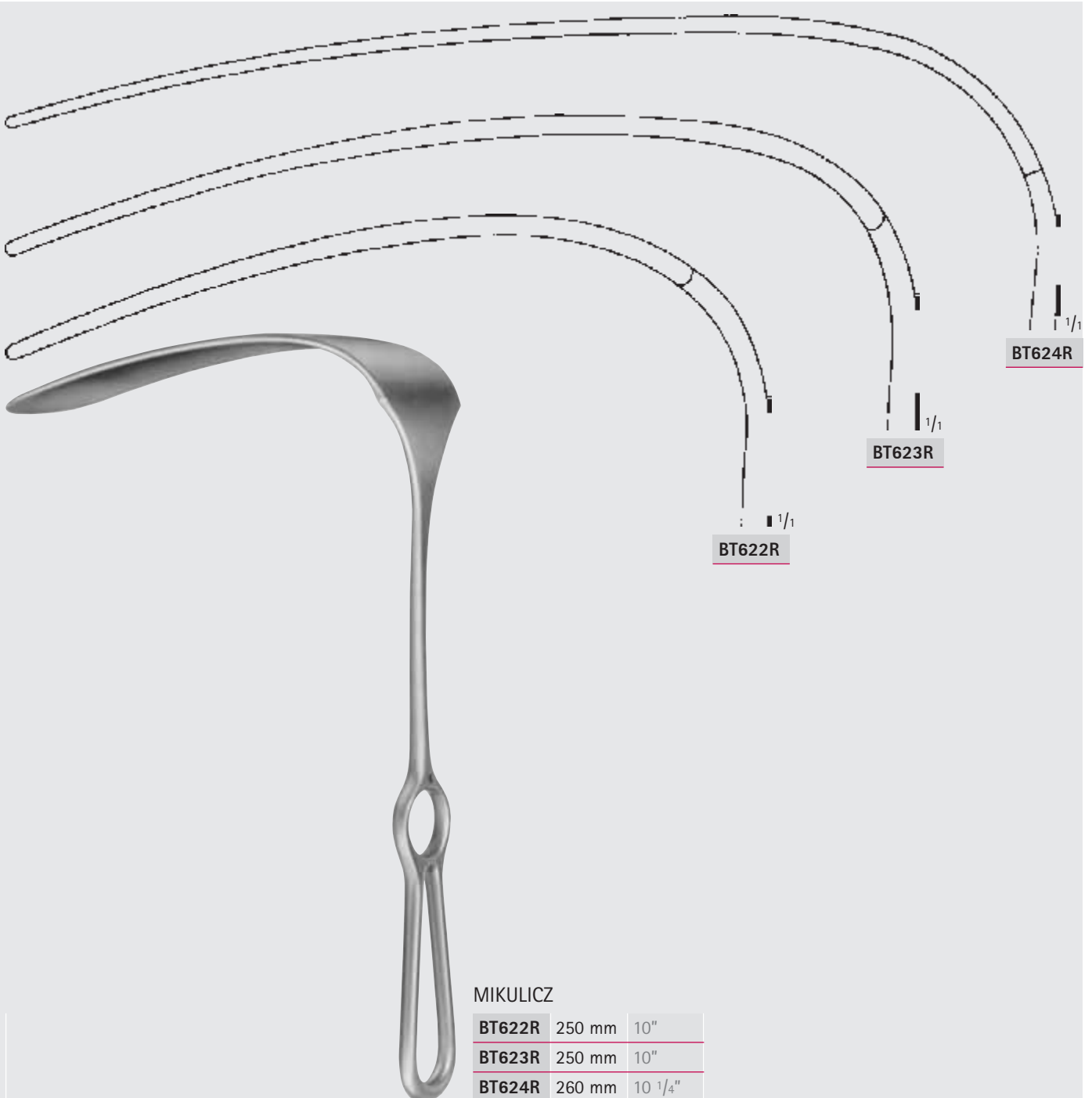
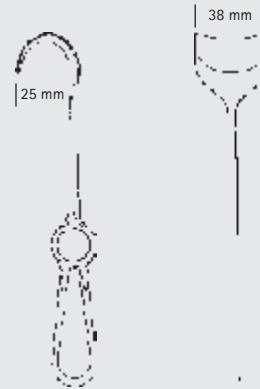

MIKULICZ

BT622R	250 mm	10"
BT623R	250 mm	10"
BT624R	260 mm	10 1/4"

BT





Wundhaken – Wound Retractors

Wundhaken für Eingriffe in der Tiefe (Bauchdeckenhaken)
Retractors for Deep Surgery (Abdominal Retractors)

BT

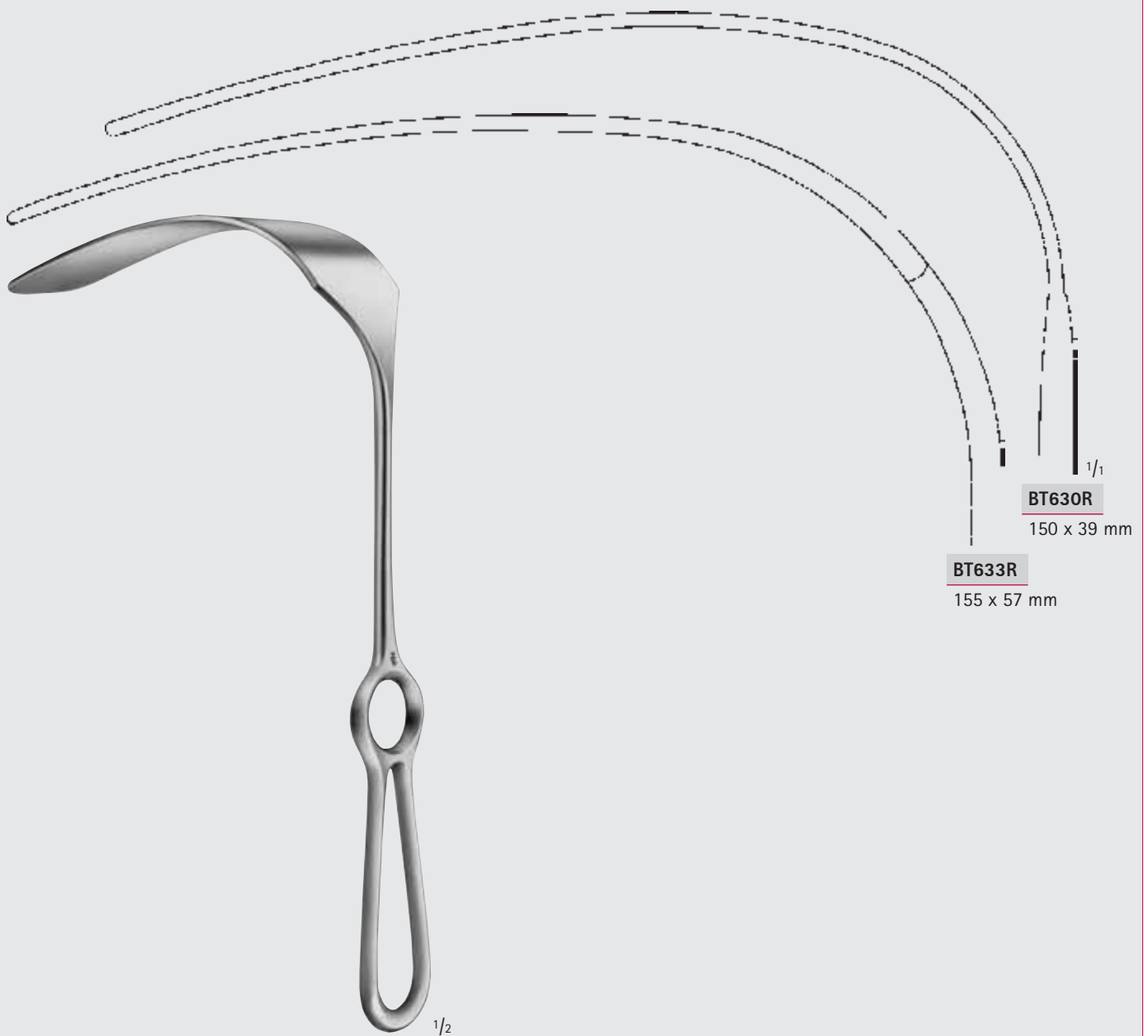

KELLY

BT630R-BT633R

260 mm, 10 1/4"

MILLIMETERS

Wundhaken – Wound Retractors

Pelvishaken

Pelvis Retractors

Maßangaben für Blattgrößen der Wundhaken

1. Zahl = Tiefe Beispiel: 25 x 38 mm

2. Zahl = Breite

Dimensions for blade size of retractors

1st number = depth Example: 25 x 38 mm

2nd number = width

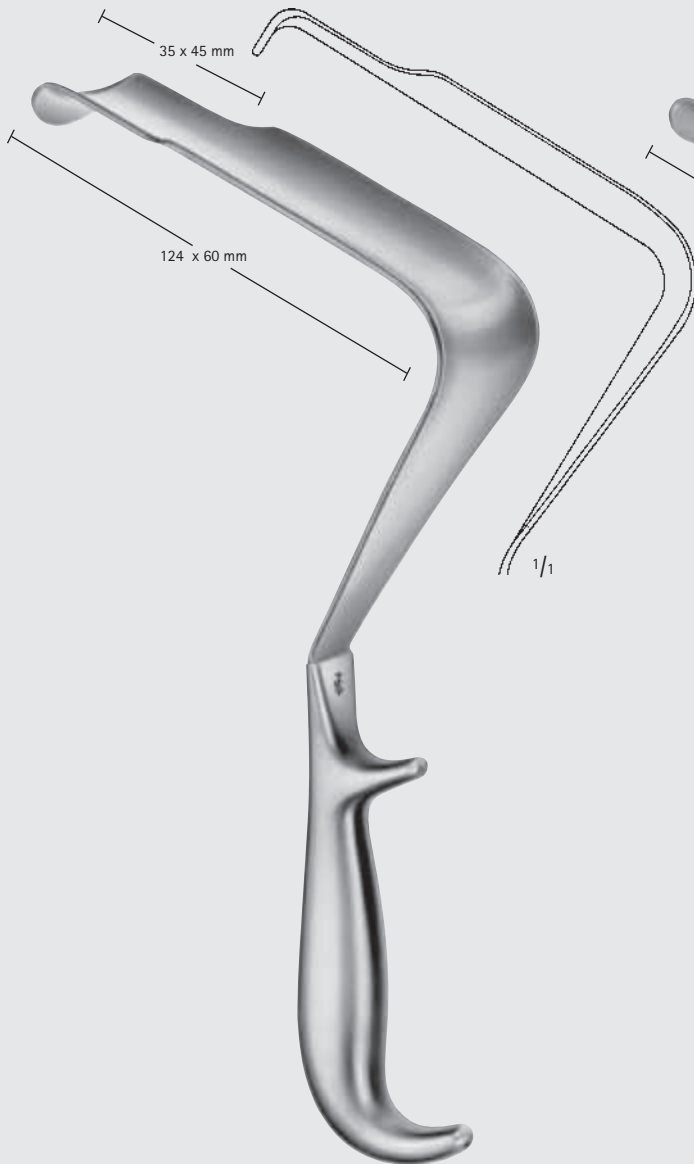
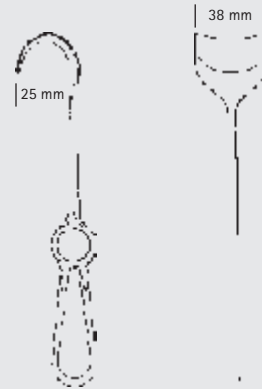

ST. MARKS

BT670R

290 mm, 11 1/2"

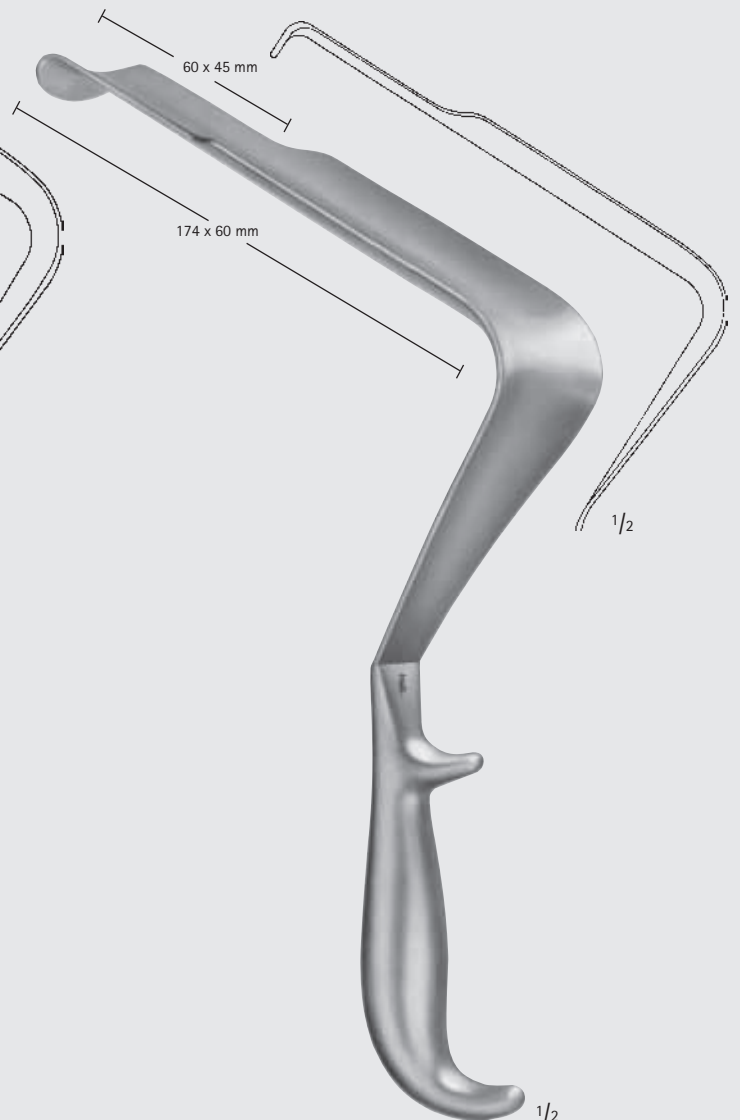

ST. MARKS

BT672R

330 mm, 13 1/8"

BT





Wundhaken – Wound Retractors
Pelvishaken
Pelvis Retractors

BT

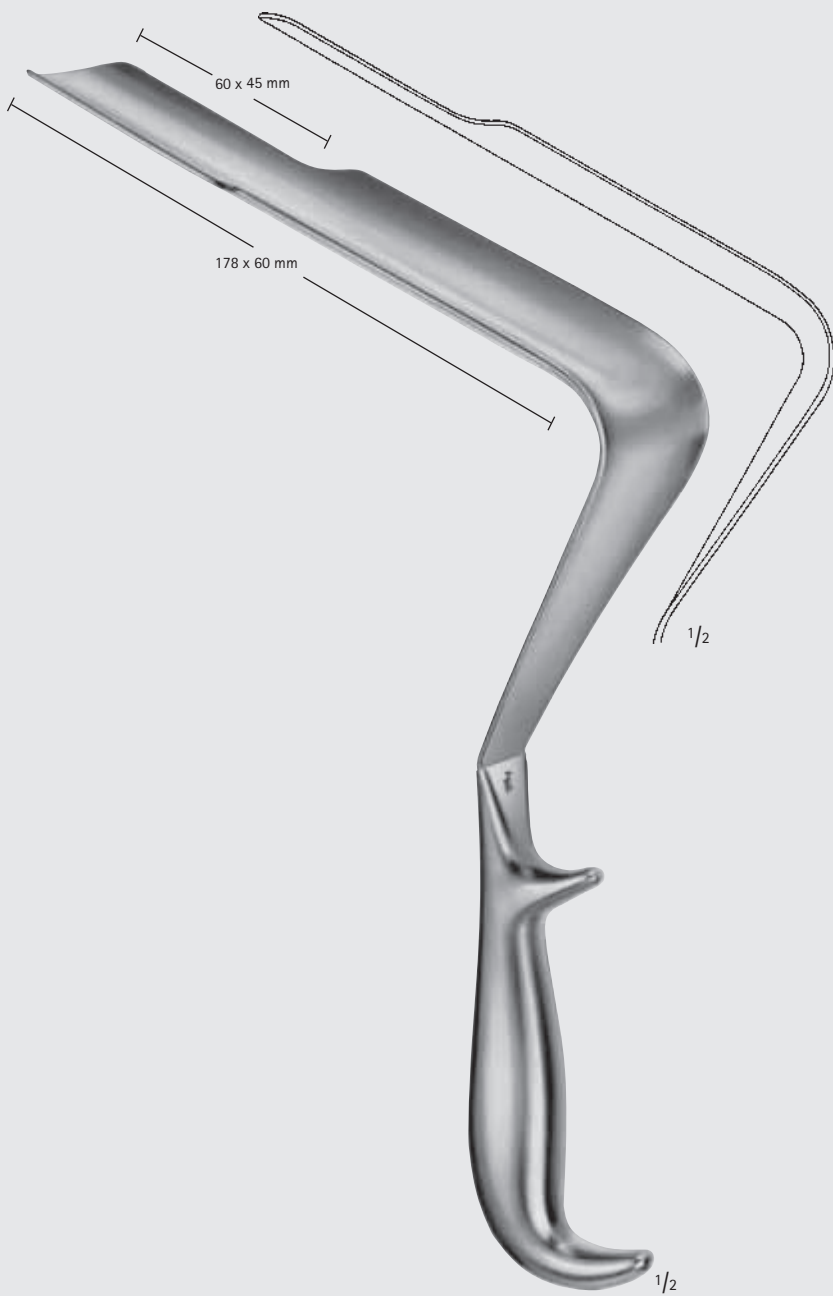

ST. MARKS

BT674R

330 mm, 13 1/8"

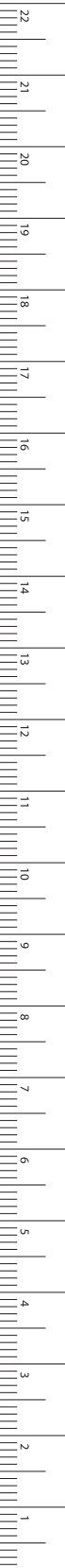

Wundhaken – Wound Retractors

Wundhaken
Retractors

Maßangaben für Blattgrößen der Wundhaken

1. Zahl = Tiefe Beispiel: 25 x 38 mm

2. Zahl = Breite

Dimensions for blade size of retractors

1st number = depth Example: 25 x 38 mm

2nd number = width



38 mm



250 x 30 mm

MÜLLER

BT626R

270 mm, 10 ³/₄"

BT





Wundhaken – Wound Retractors
Wundhaken, Bauchdeckenhaken
Retractors, Abdominal Retractors

BT



TUDOR-EDWARDS

BT500R

205 mm, 8"

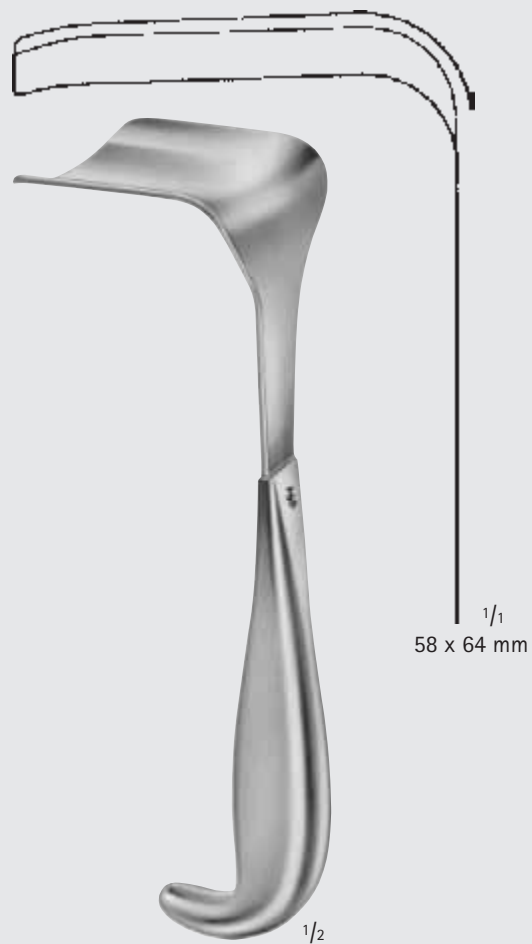

TUFFIER

BT617R

215 mm, 8 1/2"

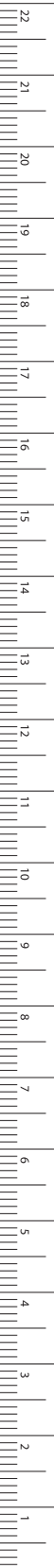

Wundhaken – Wound Retractors

Wundhaken, Bauchdeckenhaken

Retractors, Abdominal Retractors

Maßangaben für Blattgrößen der Wundhaken

1. Zahl = Tiefe Beispiel: 25 x 38 mm

2. Zahl = Breite

Dimensions for blade size of retractors

1st number = depth Example: 25 x 38 mm

2nd number = width

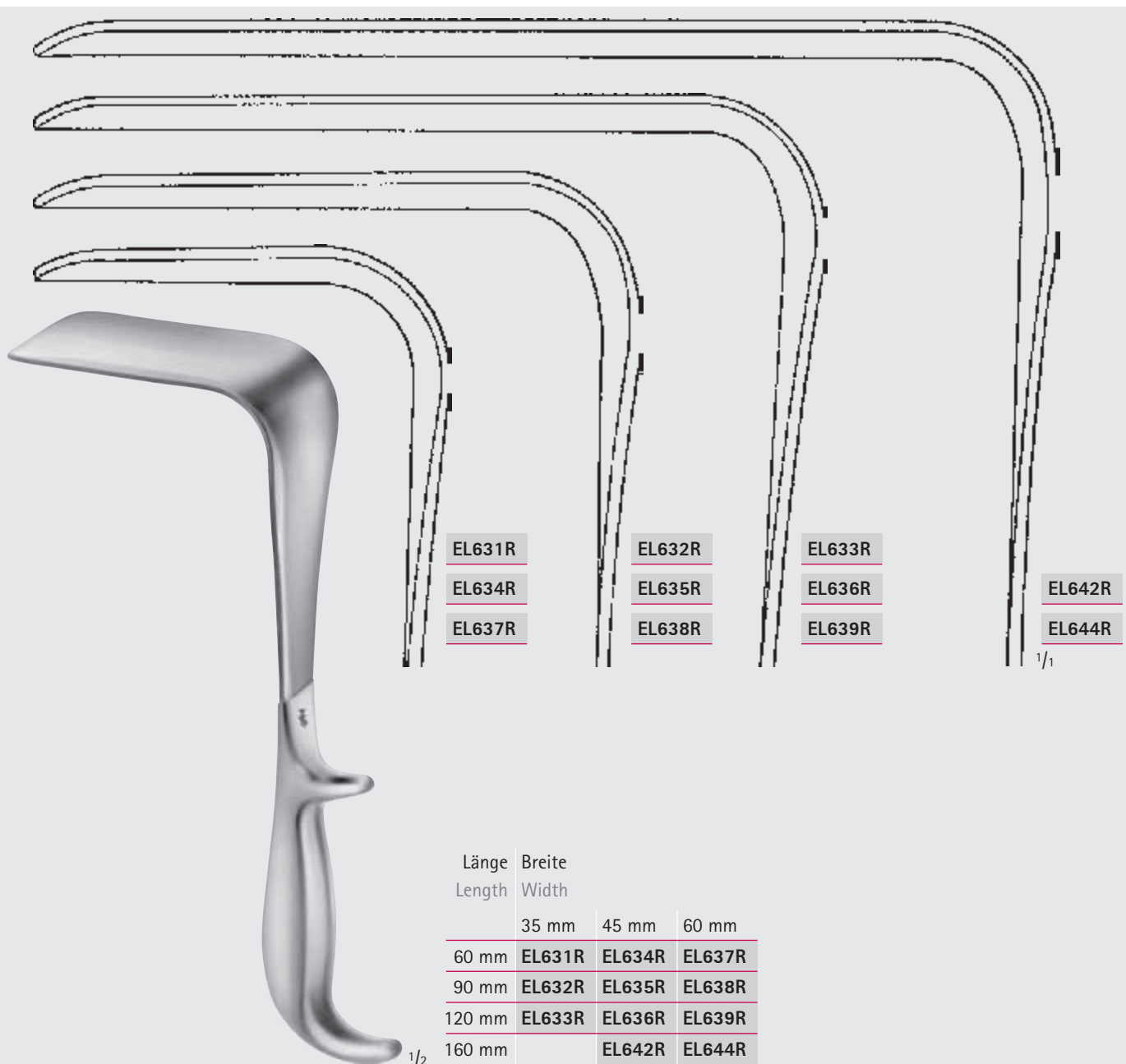
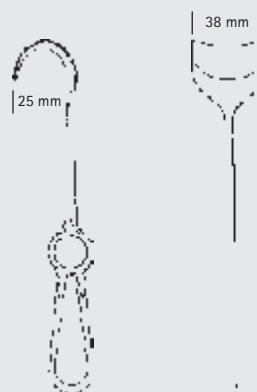

EL631R
EL634R
EL637R

EL632R
EL635R
EL638R

EL633R
EL636R
EL639R

EL642R
EL644R

Länge Length	Breite Width			
	35 mm	45 mm	60 mm	
60 mm	EL631R	EL634R	EL637R	
90 mm	EL632R	EL635R	EL638R	
120 mm	EL633R	EL636R	EL639R	
160 mm		EL642R	EL644R	

DOYEN

EL631R-EL644R

240 mm, 9 1/2"

BT





Wundhaken – Wound Retractors
 Wundhaken, Bauchdeckenhaken
 Retractors, Abdominal Retractors

BT



BT655R

Fig. 1
32 x 40 mm

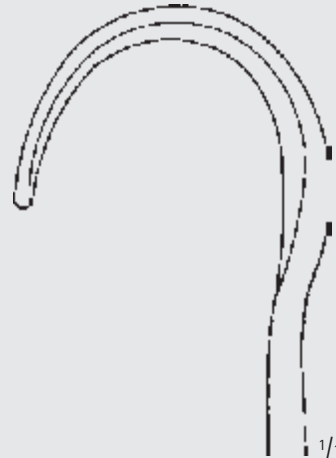

BT656R

Fig. 2
34 x 50 mm



BT657R

Fig. 3
41 x 60 mm

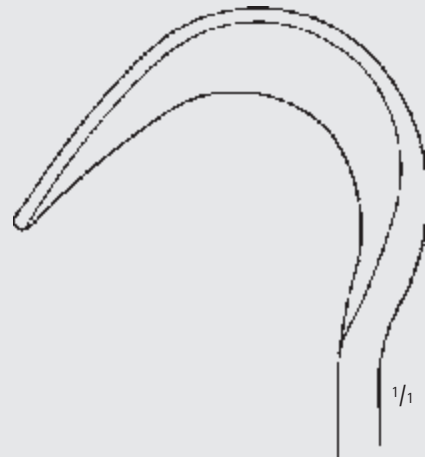

BT658R

Fig. 4
46 x 75 mm



1/2

FRITSCH

BT655R-BT659R

235 mm, 9 1/4"

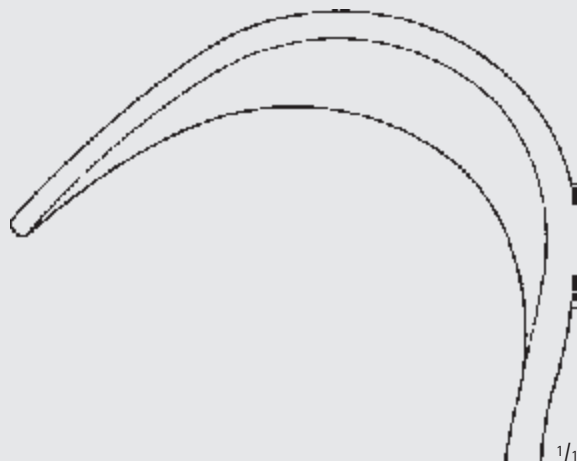

BT659R

Fig. 5
64 x 85 mm

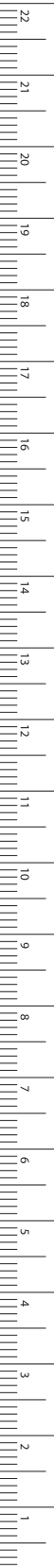

MILLIMETERS

Wundhaken – Wound Retractors

Wundhaken, Bauchdeckenhaken

Retractors, Abdominal Retractors

Maßangaben für Blattgrößen der Wundhaken

1. Zahl = Tiefe Beispiel: 25 x 38 mm

2. Zahl = Breite

Dimensions for blade size of retractors

1st number = depth Example: 25 x 38 mm

2nd number = width

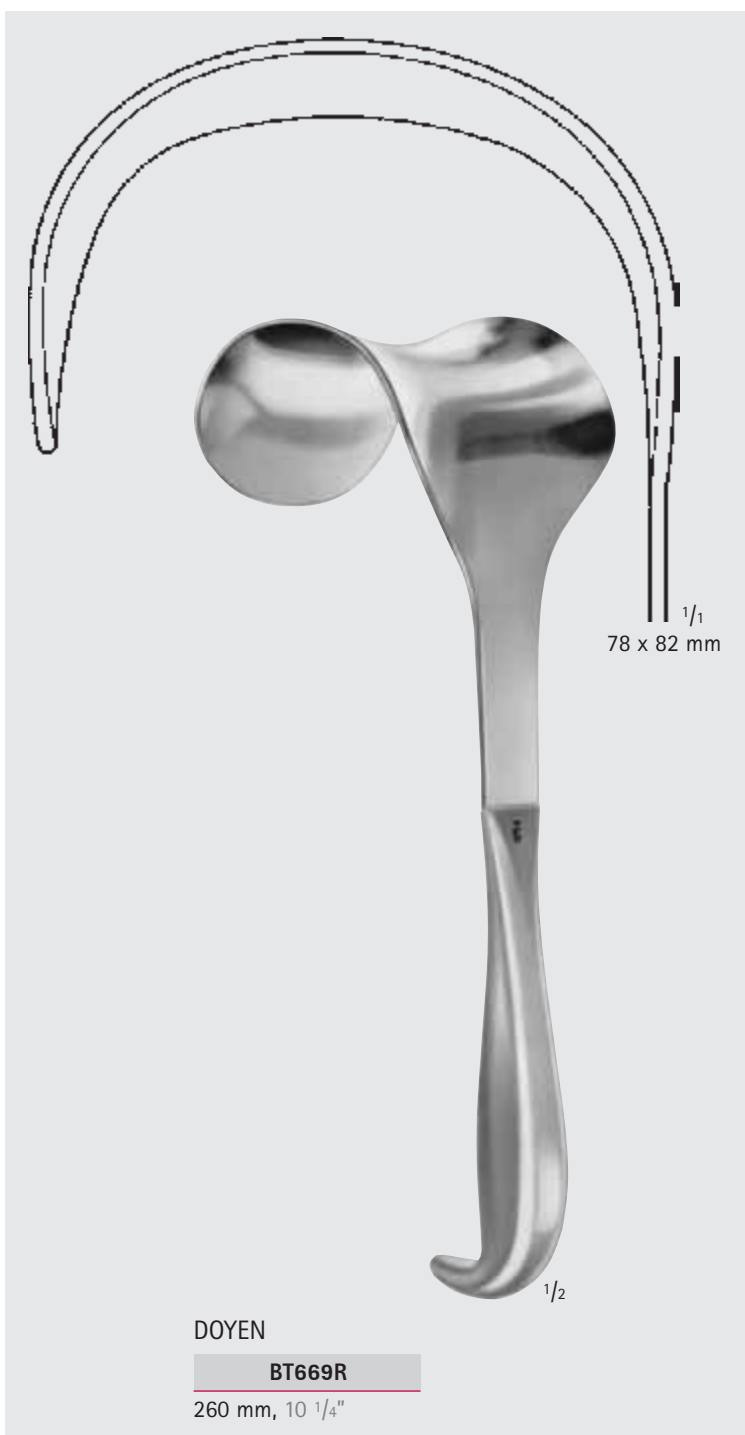
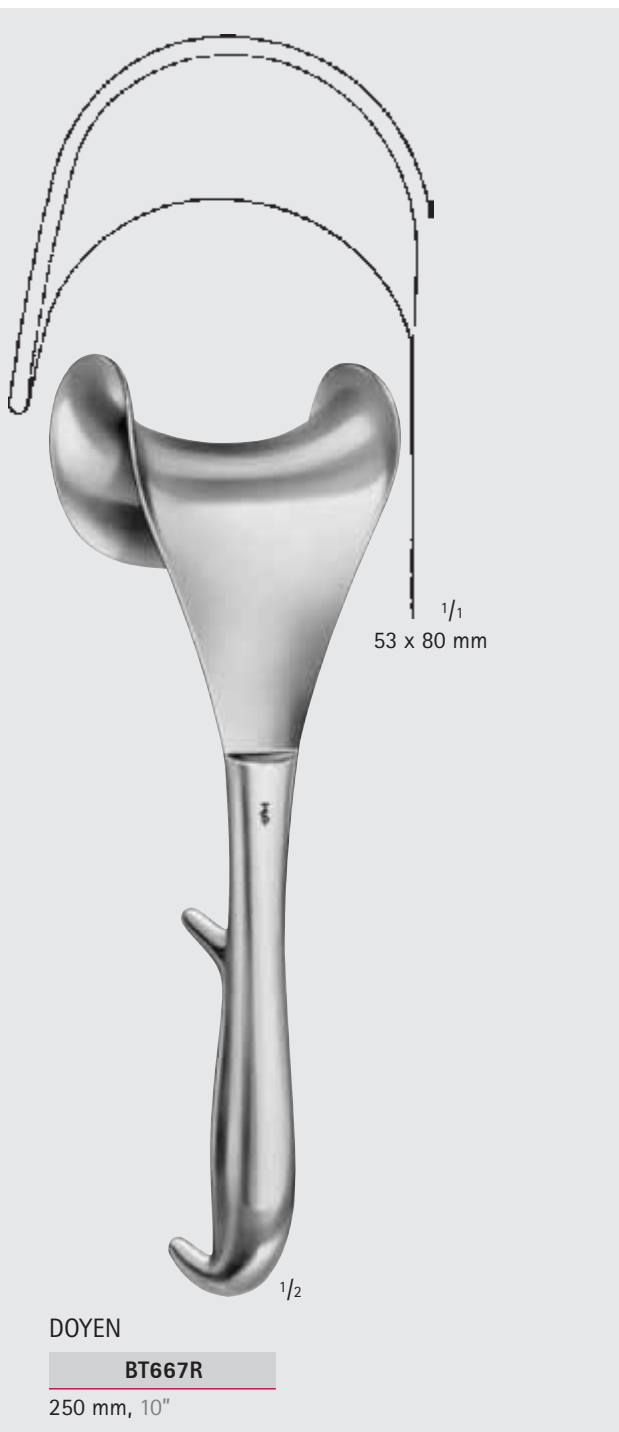
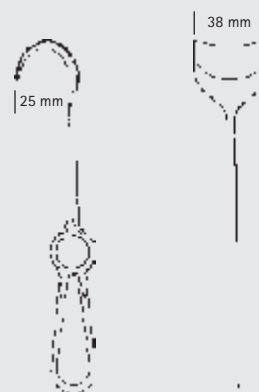



Wundhaken – Wound Retractors

Bauchdeckenhaken
Abdominal Retractors

BT



¹/₃

DOYEN

BT721R	48 x 90 mm
BT723R	48 x 105 mm
BT724R	48 x 120 mm
BT725R	48 x 135 mm

280 mm, 11"



BT703R

Kette (BT704R) mit Gewicht (EL747R/645 g)
Chain (BT704R) with weight (EL747R/645 g)
790 mm, 31"

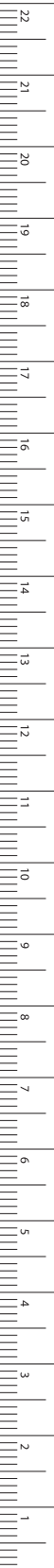

MILLIMETERS

Wundhaken – Wound Retractors

Bauchdeckenhaken

Abdominal Retractors

BT



ROCHARD

BT711R	48 x 90 mm
BT712R	48 x 105 mm
BT713R	48 x 120 mm
BT714R	48 x 135 mm
BT715R	48 x 155 mm

310 mm, 12 1/4"

1/3

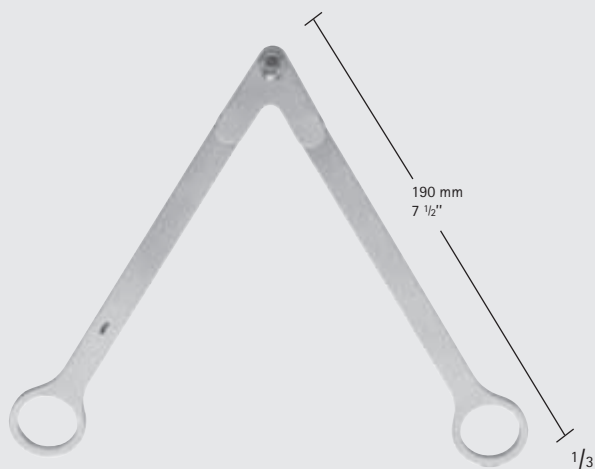

ROCHARD

BT710R

Fixiervorrichtung für
BT711R - BT715R

Fixation device for
BT711R - BT715R

190 mm, 8"

1/3



ROCHARD

BT710R-BT711R

1/3



Wundhaken – Wound Retractors

Bauchdeckenhaken Abdominal Retractors

BT

Befestigungsgestelle zu verwenden mit:
BT710R Fixiervorrichtung und
BT711R - BT715R ROCHARD Bauchdeckenhalter
Mounting frames to be used with:
BT710R Fixation device and
BT711R - BT715R ROCHARD abdominal retractors

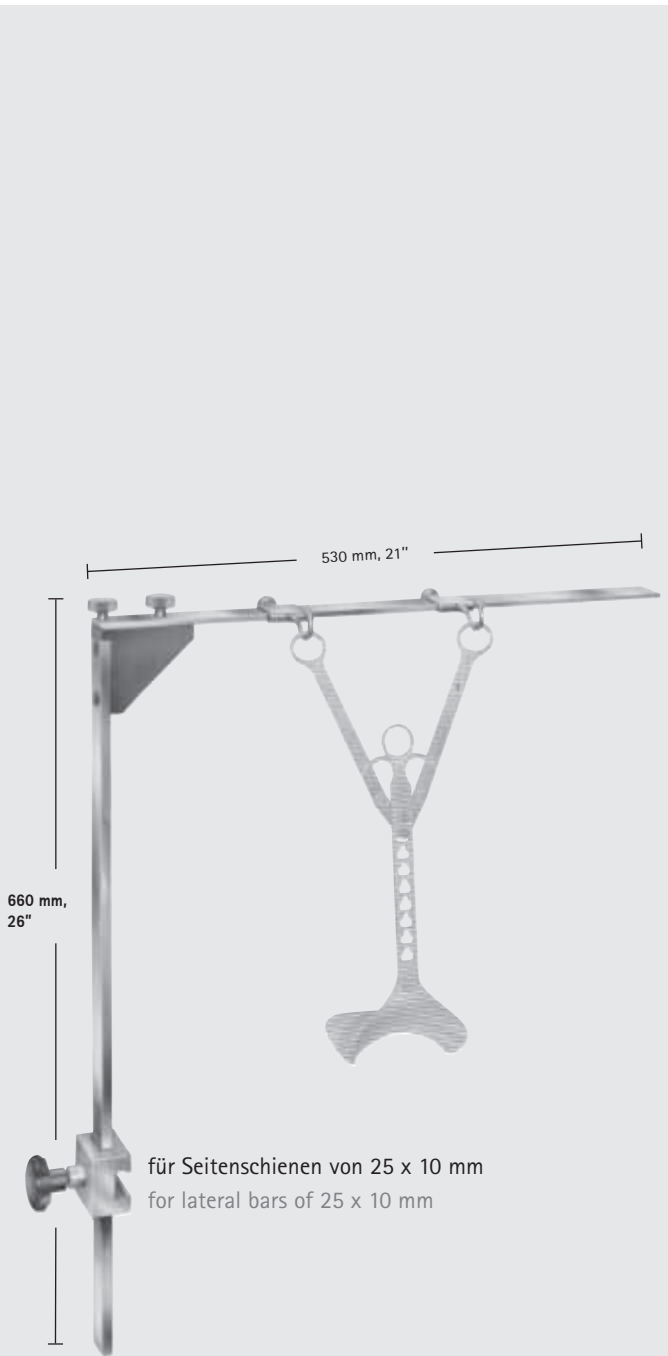

ROCHARD

BT709R

Befestigungsgestell zur Fixierung an den Seitenschienen der OP-Tische, zerlegbar zur Aufbereitung und Sterilisation.

Mounting frame for fastening to the lateral bars of the operating tables, can be dismantled for decontamination and sterilization.

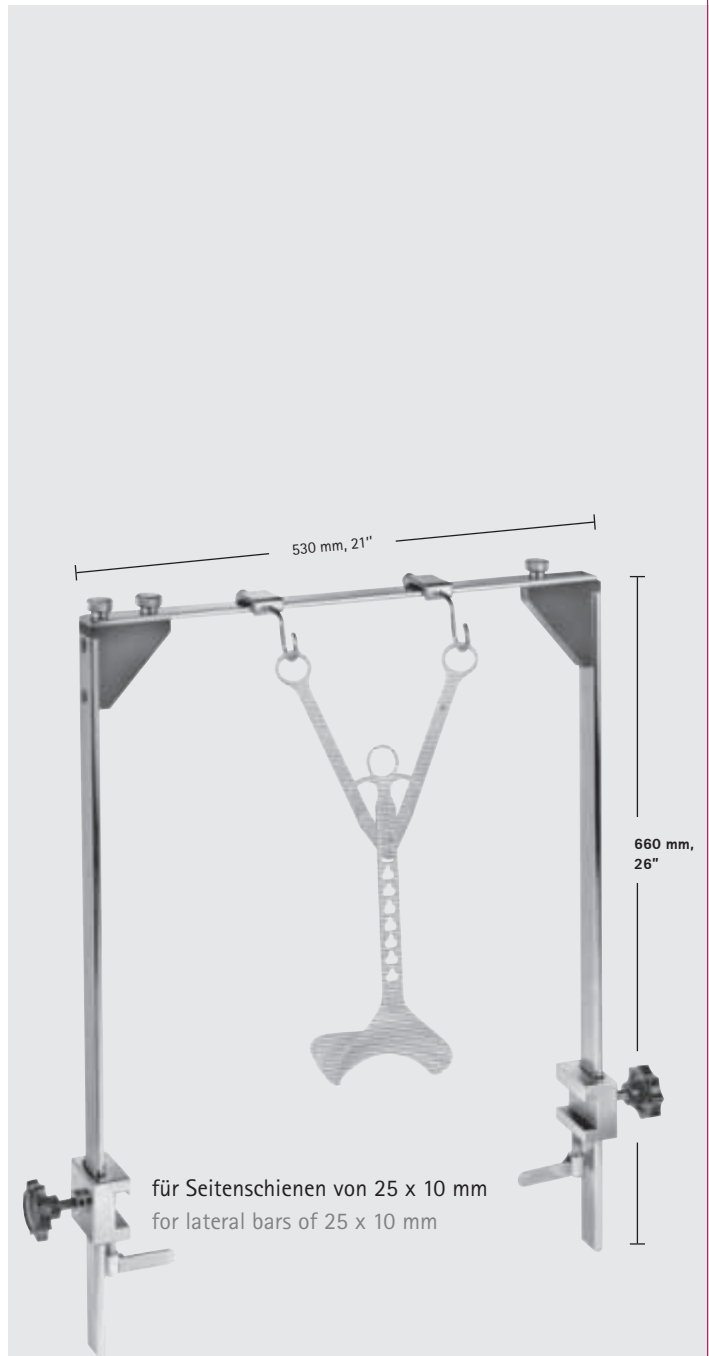

ROCHARD

BT708R

Befestigungsgestell mit beidseitiger Fixierung an den Seitenschienen der OP-Tische, dadurch mehr Stabilität, zur Aufbereitung und Sterilisation zerlegbar.

Mounting frame for fastening to both sides of the is given, can be dismantled for decontamination and sterilization.

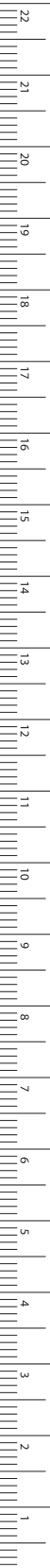

MILLIMETERS

Wundhaken – Wound Retractors

Bauch- und Darmspatel

Abdominal and Intestinal Spatulas

BT



REVERDIN

BT749R

285 mm, 11 1/4"



HABERER

BT758R

biegsam
malleable
305 mm, 12"



RIBBON

BT756R 25 mm

BT761R 30 mm

BT762R 40 mm

BT763R 50 mm

biegsam
malleable
330 mm, 13 1/8"



TUFFIER

BT750R

biegsam
malleable
200 mm, 8"



BT751R 12 mm 200 mm 8"

BT752R 17 mm 200 mm 8"

BT755R 25 mm 250 mm 10"

biegsam
malleable



Wundhaken – Wound Retractors

Bauch- und Darmspatel
Abdominal- and Intestinal Spatulas

BT



KADER

BT746R 30 mm

BT747R 40 mm

270 mm, 10 ³/₄"



biegsam
malleable

BT773R 30 mm

BT774R 40 mm

BT775R 50 mm

BT776R 60 mm

BT777R 70 mm

410 mm, 16"



MILLIMETERS

Wundhaken – Wound Retractors

Prostata- und Urethra-Retraktoren

Prostate- and Urethral Retractors

BT



1/2

BT680R

Prostata-Retraktor

Prostate retractor

360 mm, 14 3/8"



1/2

BT681R

Urethra-Retraktor

Urethral retractor

390 mm, 15 1/2"



Wundhaken – Wound Retractors
Kropflöffel, Blutschöpfer
Depressor, Blood Scoops

BT



KOCHER

BT795R

Kropflöffel
Depressor, spoon shaped
220 mm, 8 3/4"

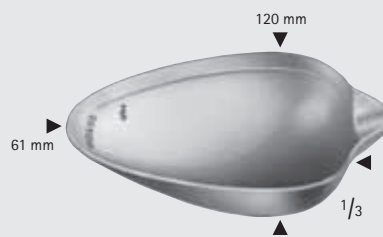

BT780R

Blutschöpfer, 50 ccm
Blood scoop, 3 cu. inches

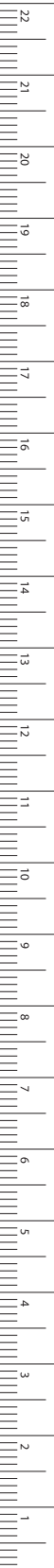

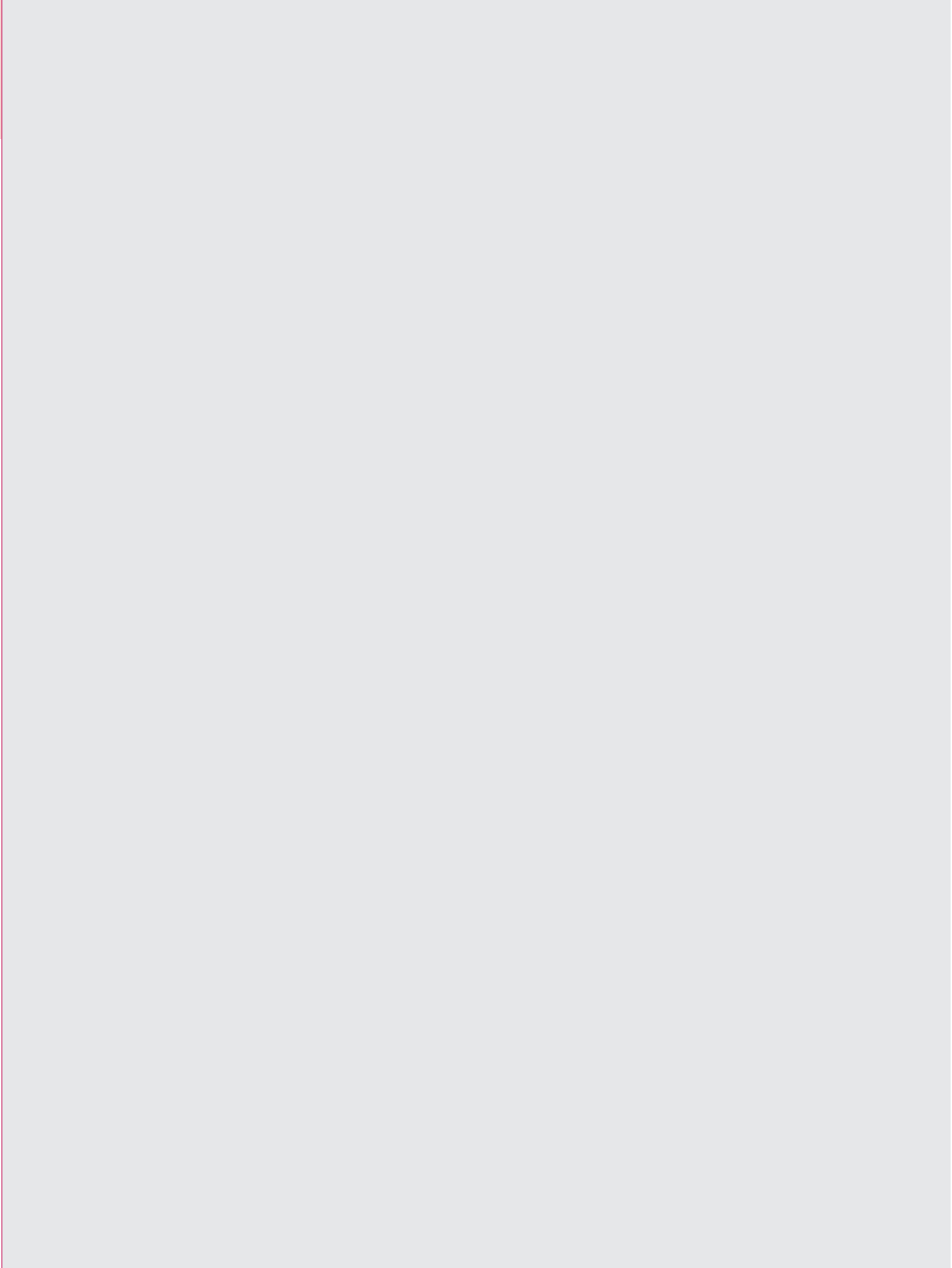



BV



Wundspreizer, Bauchdeckenhalter
Self-Retaining Retractors,
Abdominal Retractors

Wundspreizer, Bauchdeckenhalter – Self-Retaining Retractors, Abdominal Retractors

Wundspreizer

Self-Retaining Retractors

BV



BOSE

FA001R

60 mm, 2 3/8"



FINSEN

BV001R

50 mm, 2"



FINSEN

BV002R

70 mm, 2 3/4"



FINSEN MODIF.

BV003R

75 mm, 3"



FINSEN

BV005R

70 mm, 2 3/4"



BV006R

45 mm, 1 3/4"



BV007R

55 mm, 2 1/8"



Wundspreizer, Bauchdeckenhalter – Self-Retaining Retractors, Abdominal Retractors

Wundspreizer
Self-Retaining Retractors

BV

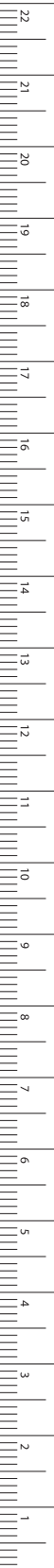

MILLIMETERS



1/2

PARSONNET

BV014R

50 mm, 2"



1/1

1/2

BV008R

stumpf
blunt
100 mm, 4"



1/1

1/2

BV015R

scharf
sharp
100 mm, 4"



1/2



BV010R	BV011R
70 mm	100 mm
2 3/4"	4"

ALM

BV010R-BV011R



1/1



1/2

LOGAN
MODIF. REILL

BV013R

50 mm, 2"

Wundspreizer, Bauchdeckenhalter – Self-Retaining Retractors, Abdominal Retractors

Wundspreizer, Lidsperrer

Self-Retaining Retractors, Lid Retractors

BV



ALLPORT

BV028R

95 mm, 3 3/4"

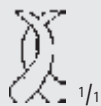

JANSEN

BV030R

100 mm, 4"

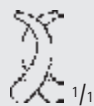

JANSEN

BV032R

100 mm, 4"



JANSEN

BV033R

100 mm, 4"



BARRAQUER

OA200R

45 mm, 1 3/4"



SAUER

OA218R

35 mm, 1 3/8"



LANCASTER

OA225R

80 mm, 3 1/8"



Wundspreizer, Bauchdeckenhalter – Self-Retaining Retractors, Abdominal Retractors

Wundspreizer
Self-Retaining Retractors

BV

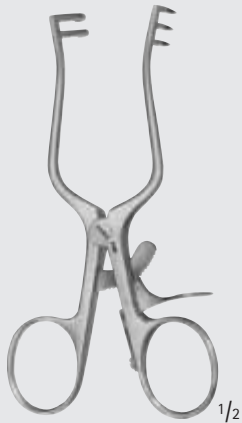

WEITLANER

BV070R

scharf

sharp

110 mm, 4 3/8"

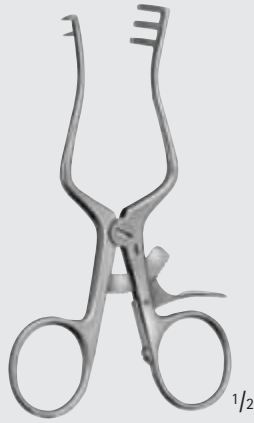
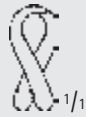

WEITLANER

BV066R

halbscharf

semi-sharp

110 mm, 4 3/8"

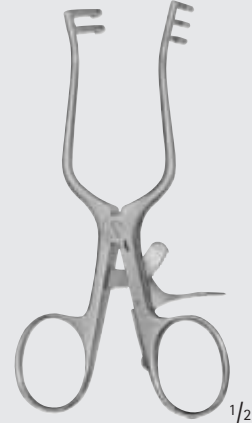
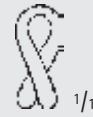

WEITLANER

BV073R

stumpf

blunt

110 mm, 4 3/8"



WEITLANER

BV071R

scharf

sharp

130 mm, 5 1/8"

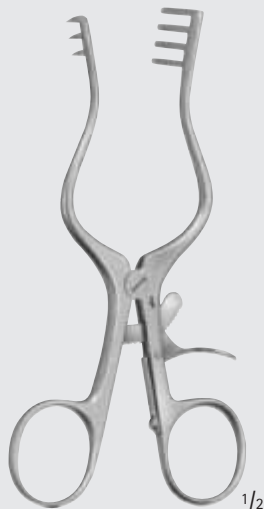
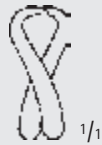

WEITLANER

BV067R

halbscharf

semi-sharp

130 mm, 5 1/8"



WEITLANER

BV074R

stumpf

blunt

130 mm, 5 1/8"

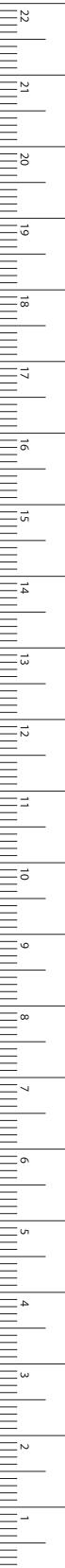

MILLIMETERS

Wundspreizer, Bauchdeckenhalter – Self-Retaining Retractors, Abdominal Retractors

Wundspreizer

Self-Retaining Retractors

BV



WEITLANER

BV101R

scharf

sharp

130 mm, 5 1/8"

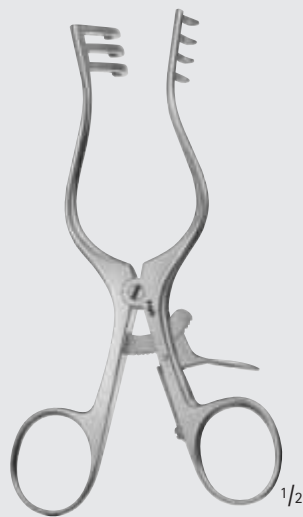

WEITLANER

BV104R

stumpf

blunt

130 mm, 5 1/8"

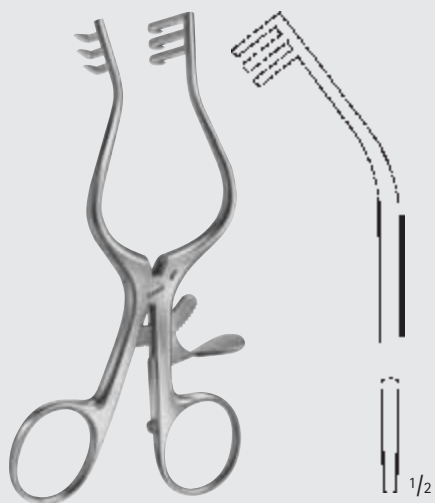

WULLSTEIN

BV076R

scharf

sharp

130 mm, 5 1/8"

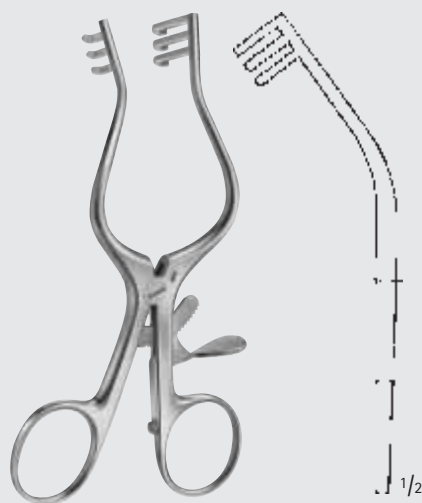
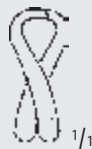

WULLSTEIN

BV077R

stumpf

blunt

130 mm, 5 1/8"



Wundspreizer, Bauchdeckenhalter – Self-Retaining Retractors, Abdominal Retractors

Wundspreizer
Self-Retaining Retractors

BV



WEITLANER

BV072R

scharf

sharp

165 mm, 6 1/2"



WEITLANER

BV068R

halbscharf

semi-sharp

165 mm, 6 1/2"



WEITLANER

BV075R

stumpf

blunt

165 mm, 6 1/2"



ALLENBERG

BV097R

Carotis-Sperrer komplett,
bestehend aus:

BV098R Sperrer allein, stumpf

BV099R Mittelblatt allein,
120 mm, 4 3/4"

Carotid retractor complete,
consisting of:

BV098R Retractor only, blunt

BV099R Center blade only,
120 mm, 4 3/4"

170 mm, 6 3/4"



MILLIMETERS

Wundspreizer, Bauchdeckenhalter – Self-Retaining Retractors, Abdominal Retractors

Wundspreizer

Self-Retaining Retractors

BV

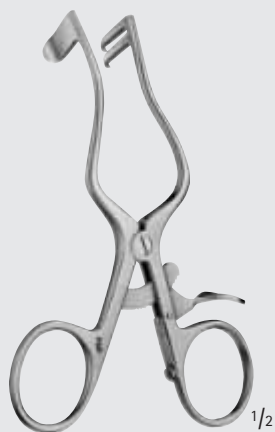

PLESTER

BV090R

stumpf

blunt

110 mm, 4 3/8"

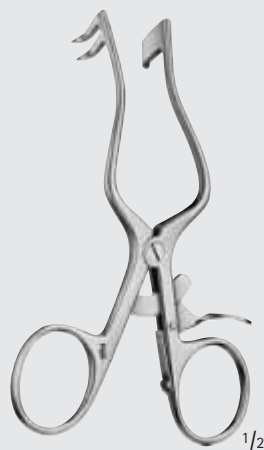

PLESTER

BV091R

stumpf

blunt

110 mm, 4 3/8"

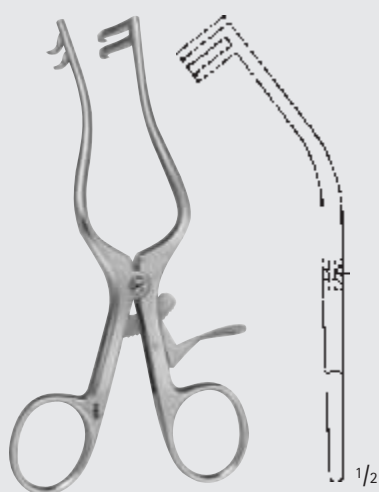

PLESTER

BV078R

scharf

sharp

130 mm, 5 1/8"

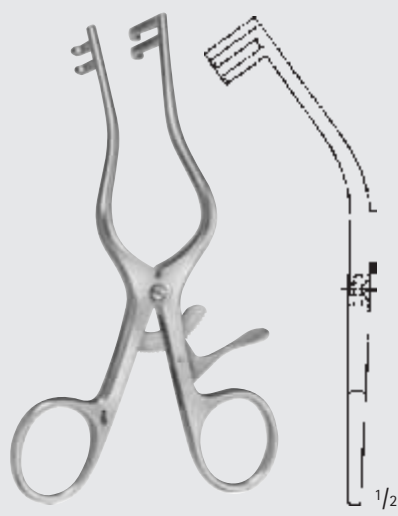

PLESTER

BV079R

stumpf

blunt

130 mm, 5 1/8"



Wundspreizer, Bauchdeckenhalter – Self-Retaining Retractors, Abdominal Retractors

Wundspreizer
Self-Retaining Retractors

BV

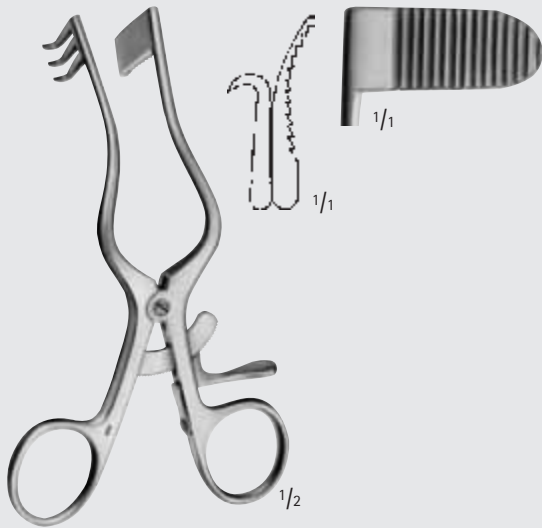

PERKINS

OK794R

130 mm, 5 1/8"

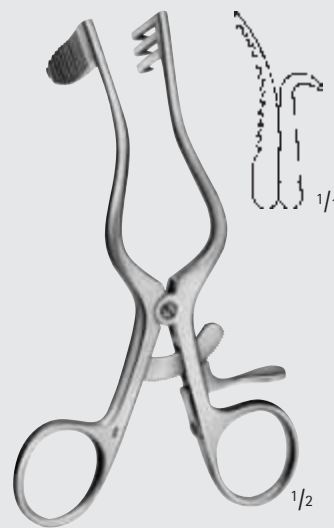

PERKINS

OK795R

130 mm, 5 1/8"



RNTNE HOSPITAL

BV084R

scharf

sharp

165 mm, 6 1/2"



ADSON-BABY

BV085R 140 mm 5 1/2"

BV094R 165 mm 6 1/2"

halbscharf

semi-sharp

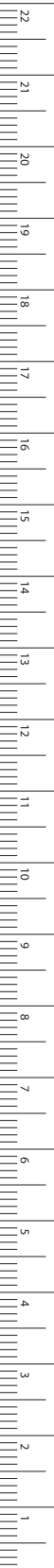

MILLIMETERS

Wundspreizer, Bauchdeckenhalter – Self-Retaining Retractors, Abdominal Retractors

Wundspreizer

Self-Retaining Retractors

BV



1/2

JEFFERSON

BV092R

gebogen, stumpf

curved, blunt

140 mm, 5 1/2"



1/2

MOLLISON

BV093R

scharf

sharp

140 mm, 5 1/2"



1/2

MOLLISON

BV088R

scharf

sharp

155 mm, 6"



Wundspreizer, Bauchdeckenhalter – Self-Retaining Retractors, Abdominal Retractors

Wundspreizer
Self-Retaining Retractors

BV

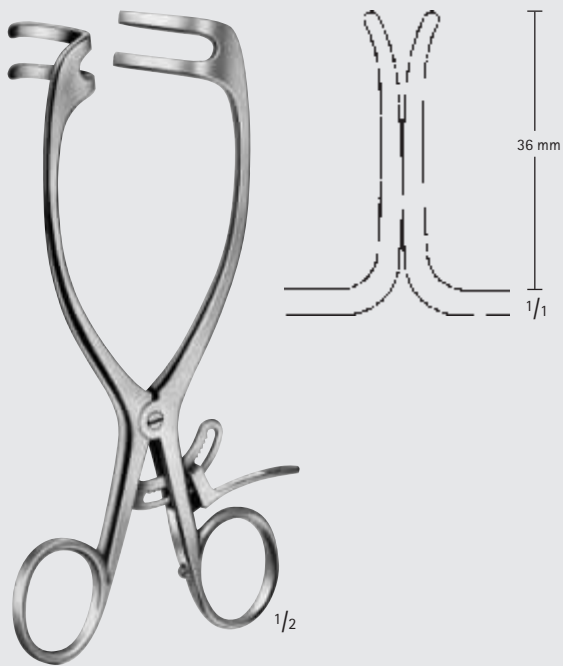

MAYO-ADAMS

BV112R

165 mm, 6 1/2"



HENDERSON

BV113R

scharf

sharp

180 mm, 7"

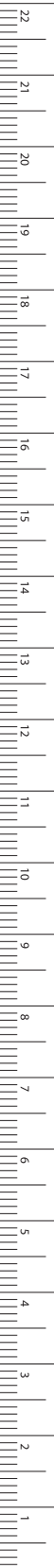

MILLIMETERS

Wundspreizer, Bauchdeckenhalter – Self-Retaining Retractors, Abdominal Retractors

Wundspreizer

Self-Retaining Retractors

BV

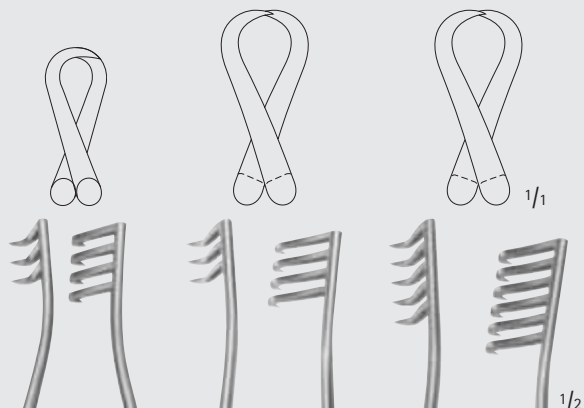

BV200R

scharf
sharp
195 mm
7 3/4"

BV206R

scharf
sharp
240 mm
9 1/2"

BV208R

scharf
sharp
255 mm
10"

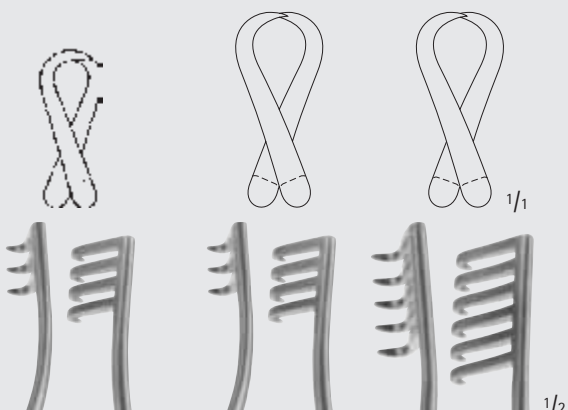

BV199R

halbscharf
semi-sharp
195 mm
7 3/4"

BV203R

halbscharf
semi-sharp
240 mm
9 1/2"

BV205R

halbscharf
semi-sharp
255 mm
10"

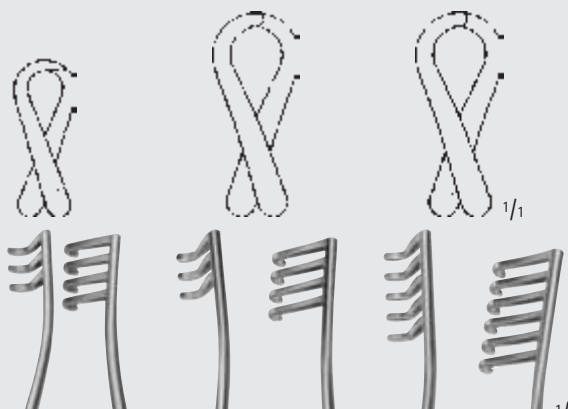

BV201R

stumpf
blunt
195 mm
7 3/4"

BV207R

stumpf
blunt
240 mm
9 1/2"

BV209R

stumpf
blunt
255 mm
10"



WEITLANER

BV199R-BV209R



Wundspreizer, Bauchdeckenhalter – Self-Retaining Retractors, Abdominal Retractors

Wundspreizer
Self-Retaining Retractors

BV



IRWIN

BV247R

scharf
sharp
175 mm, 7"



TRAVERS

BV249R

stumpf
blunt
215 mm, 8"



MILLIMETERS

Wundspreizer, Bauchdeckenhalter – Self-Retaining Retractors, Abdominal Retractors

Laminektomie-Wundspreizer

Self-Retaining Laminectomy Retractors

BV



ANDERSON-ADSON

BV250R

scharf

sharp

190 mm, 7 1/2"



NORFOLK AND NORWICH

BV248R

stumpf

blunt

220 mm, 8 3/4"



ADSON

BV252R

scharf

sharp

265 mm, 10 1/2"



Wundspreizer, Bauchdeckenhalter – Self-Retaining Retractors, Abdominal Retractors

Laminektomie-Wundspreizer

Self-Retaining Laminectomy Retractors

BV

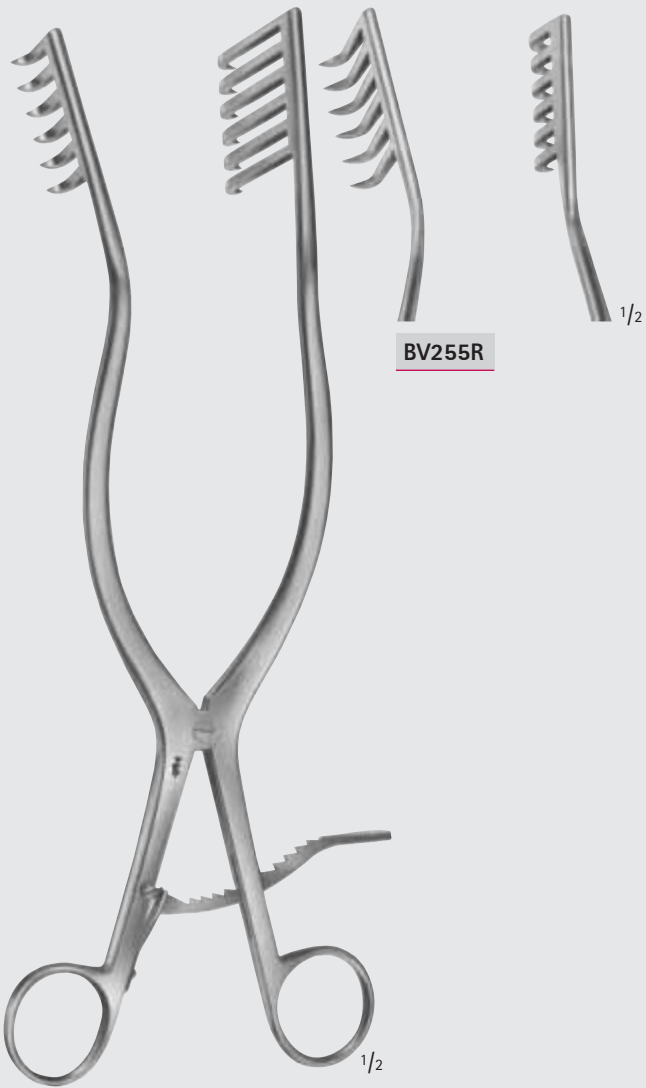
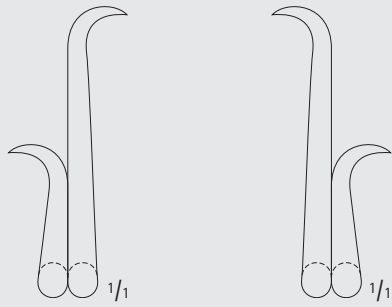

BV255R

BV254R-BV255R

Hemilaminektomiespreizer
scharf
Hemi-laminectomy retractor
sharp
280 mm, 11"



CONE

BV260R

scharf
sharp
265 mm, 10 1/2"

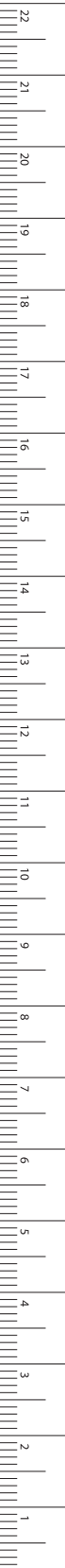

MILLIMETERS

Wundspreizer, Bauchdeckenhalter – Self-Retaining Retractors, Abdominal Retractors

Laminektomie-Wundspreizer

Self-Retaining Laminectomy Retractors

BV

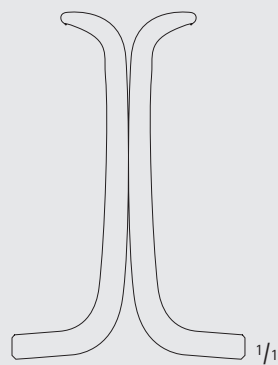

BECKMANN-ADSON

BV271R

halbscharf
semi-sharp
310 mm, 12"

BECKMANN-ADSON

BV272R

scharf
sharp
310 mm, 12"

HARVEY-JACKSON

BV258R

scharf
sharp
280 mm, 11"



Wundspreizer, Bauchdeckenhalter – Self-Retaining Retractors, Abdominal Retractors

Laminektomie-Wundspreizer

Self-Retaining Laminectomy Retractors

BV



ADSON

BV273R

halbscharf

semi-sharp

320 mm, 12 3/4"

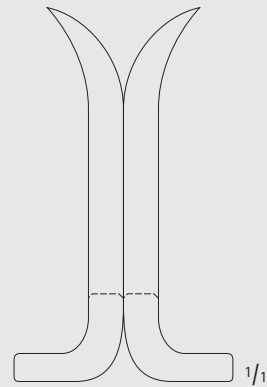

BECKMANN-EATON

BV276R

scharf

sharp

320 mm, 12 3/4"

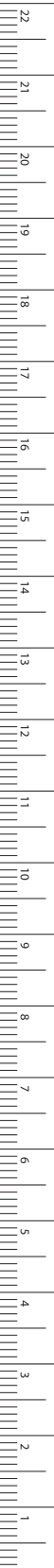

MILLIMETERS

Wundspreizer, Bauchdeckenhalter – Self-Retaining Retractors, Abdominal Retractors

Spezialwundspreizer

Special Retractors

BV

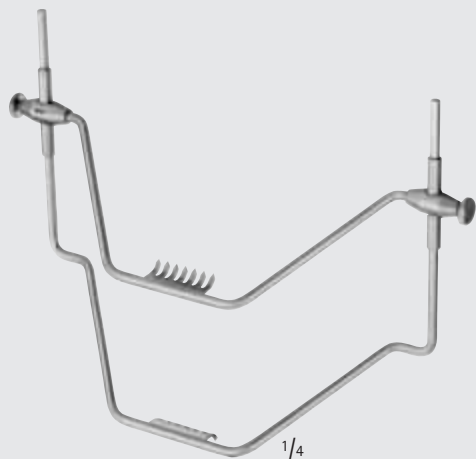
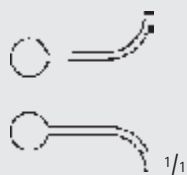

BV086R

Strumaspreizer
Thyroid retractor



JOLL (FRIEDMANN)

BV087R

Thyreoid- und Vulva-Spreizer
Thyroid- and vaginal retractor
155 mm, 6"

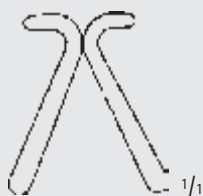

JACKSON-BURROWS

BV993R

Wundspreizer, stumpf
Retractor, blunt
185 mm, 7 1/4"

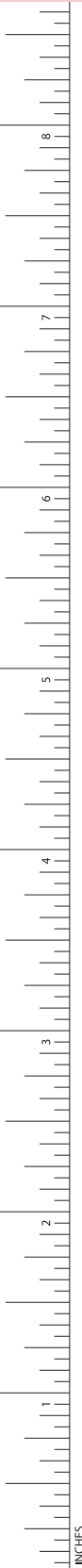



Wundspreizer, Bauchdeckenhalter – Self-Retaining Retractors, Abdominal Retractors

Spezialwundspreizer
Special Retractors

BV



GELPI

BV996R

Vulva-Spreizer
Vaginal retractor
135 mm, 5 1/4"



GELPI

BV997R

Haut- und Vulva-Spreizer
Skin- and vaginal retractor
175 mm, 7"

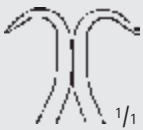

DE BAKEY

BV998R

Femur-Wundspreizer für Kinder
Femur retractor for children
100 mm, 4"



DE BAKEY

BV999R

Femur-Wundspreizer
Femur retractor
145 mm, 5 3/4"

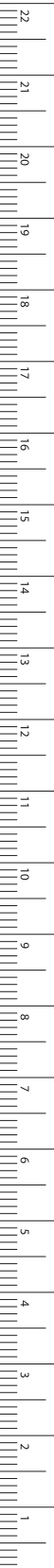

MILLIMETERS

Wundspreizer, Bauchdeckenhalter – Self-Retaining Retractors, Abdominal Retractors

Trachealdilatatoren

Tracheal Dilators

BV

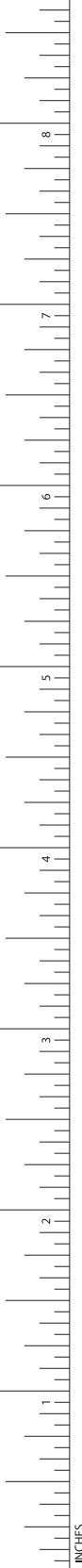

TROUSSEAU

FA005R

120 mm, 4 3/4"

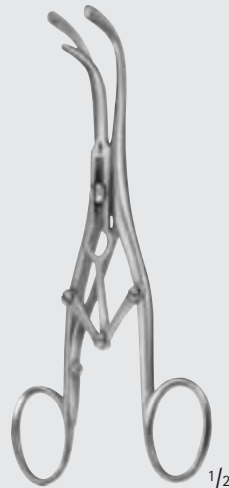

LABORDE

FA006R

125 mm, 5"



LABORDE

FA007R

kräftiges Modell
strong pattern

135 mm, 5 1/4"



Wundspreizer, Bauchdeckenhalter – Self-Retaining Retractors, Abdominal Retractors

Iliaca-Sperrer
Iliaca Retractor

BV



BV712T
30 x 30 mm



BV713T
90 x 60 mm



BV709R
Pinzette zum
Valvenwechsel
Forceps for changing
the blades
130 mm, 5 1/8

ALLENBERG

BV710R

Iliaca-Sperrer komplett,
bestehend aus:

- BV711R Sperrer allein
- BV712T Retraktorblatt lateral
- BV713T Retraktorblatt medial

Iliac retractor complete,
consisting of:

- BV711R Retractor only
- BV712T Retractor blade lateral
- BV713T Retractor blade medial

Sperrersystem zur idealen Darstellung der Arteria iliaca communis. Die Retraktorblätter sind aus Titan gefertigt und sind dadurch röntgentransparent. Das große mediale Retraktorblatt kann intraoperativ stufenweise verstellt werden. Das Sperrersystem kann aufgrund der einfachen Auswechselbarkeit der Valven links- sowie rechtseitig eingesetzt werden.

Retractor system for optimal approach to the arteria iliaca communis. The retractor blades are made out of titanium and therefore they are radiotransparent. The big medial retractor blade can be gradually adjusted during the operation. Because of the blades which are easy to exchange the retractor system can be used for the left and the right side.



MILLIMETERS

Wundspreizer, Bauchdeckenhalter – Self-Retaining Retractors, Abdominal Retractors

Wundspreizer für Laminektomie und andere Applikationen

Self-Retaining Retractors for Laminectomy and Other Applications

BV

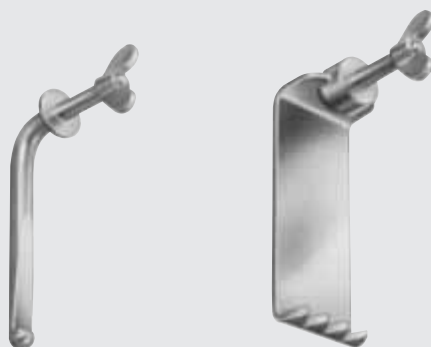

SCOVILLE

BV403R

55 mm



SCOVILLE

BV405R

63 x 25 mm

BV406R

63 x 51 mm

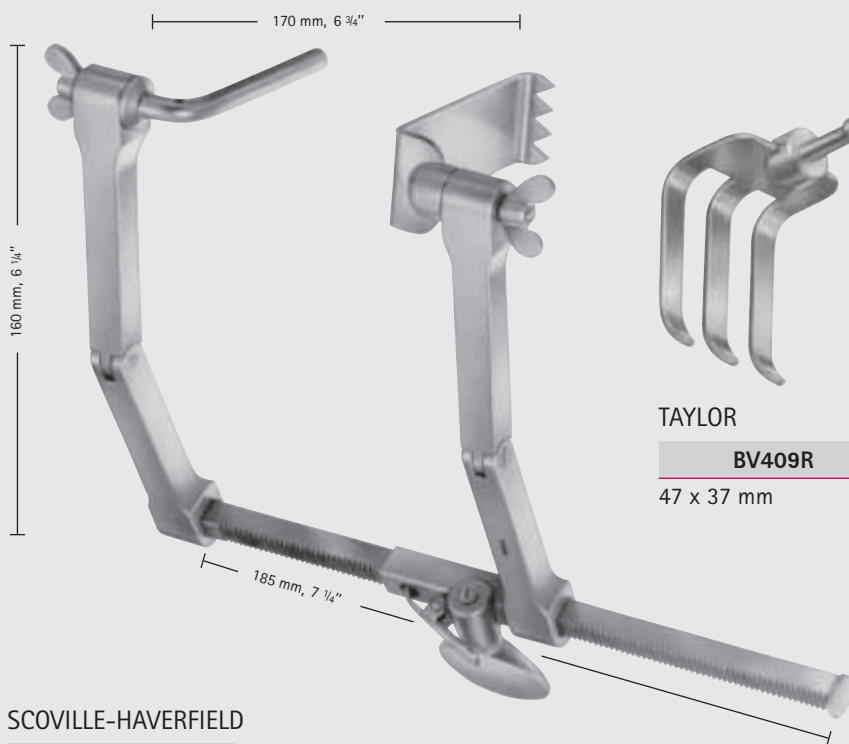

TAYLOR

BV409R

47 x 37 mm



TAYLOR

BV411R

62 x 52 mm

SCOVILLE-HAVERFIELD

BV400R

Sperrer komplett,
bestehend aus:

- BV401R Rahmen allein
- BV403R Haken
- BV405R Blatt

Retractor complete,
consisting of:

- BV401R Frame only
- BV403R Hook
- BV405R Blade



Wundspreizer, Bauchdeckenhalter – Self-Retaining Retractors, Abdominal Retractors

Wundspreizer für Laminektomie und andere Applikationen
Self-Retaining Retractors for Laminectomy and Other Applications



Aesculap Kugelschnellverschluss an Sperrern und Blättern

Vorteile:

- ⌘ Sicheres Arretieren der Blätter ohne zusätzliche Verriegelung.
- ⌘ Verhindert Herausfallen der Blätter aus den Sperrern, auch beim Anreichen.
- ⌘ Glatte Oberfläche, dadurch können Ligaturfäden nicht hängenbleiben.
- ⌘ Schnelles, problemloses Auswechseln der Blätter, auch intraoperativ.
- ⌘ Universelle Kombinationsmöglichkeiten der verschiedenen Sperrernmodelle untereinander.
- ⌘ Dadurch optimale Auswahl der Blattgrößen entsprechend den jeweiligen operativen Erfordernissen.

Aesculap ball snap system on spreaders and blades

Advantages:

- ⌘ Without additional fixation blades are safely locked
- ⌘ and can therefore not fall off the retractor shanks even the instrument is passed on to the surgeon
- ⌘ no risk of catching suture due to smooth surface
- ⌘ Without any trouble blades can be quickly exchanged also during the operation
- ⌘ Different retractors patterns can be universally combined and exchanged at random, which allows
- ⌘ optimum selection of the blade size according to surgical needs.

BV

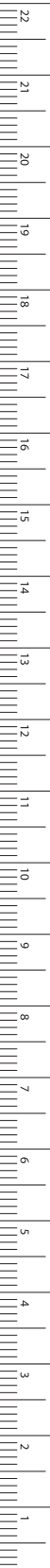

KUGELSCHNELLVERSCHLUSS BALL SNAP CLOSURE

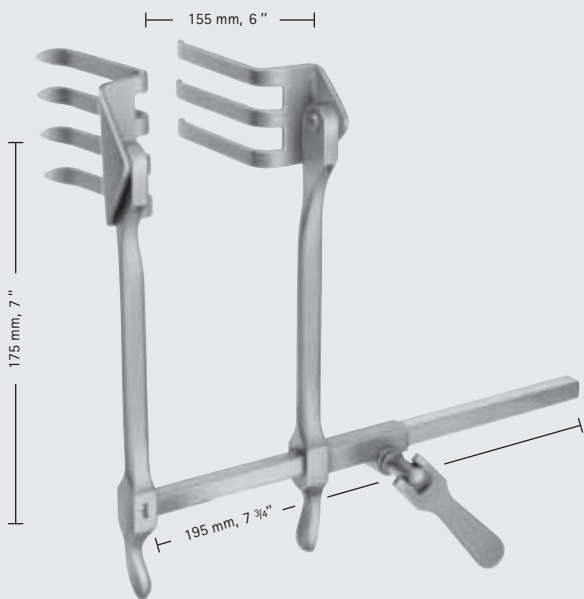

SCOVILLE-RICHTER

BV510R

Sperrer komplett,
umlegbares Modell
bestehend aus:

- BV509R Sperrer allein
- BV516R Blätter (Paar)

Kann in angelegtem Zustand zum Tücherwechsel
usw. auf die andere Seite umgelegt werden.

Retractor complete,
reversible type
consisting of:

- BV509R Retractor only
- BV516R Blades (pair)

The retractor bar and shanks may be easily rotated
180° when blades are in situ.



BV516R

62 x 52 mm
PAA = Paar

62 x 37 mm

BV517R

47 x 51 mm

PAA = Pair



BV518R

30 x 40 mm



BV519R

37 x 62 mm

MILLIMETERS

Wundspreizer, Bauchdeckenhalter – Self-Retaining Retractors, Abdominal Retractors

Wundspreizer für die Wirbelsäule
Self-Retaining Retractors for Spine



KUGELSCHNELLVERSCHLUSS MIT VERDREHSICHERUNG
BALL SNAP CLOSURE WITH TORRSION LOCK

BV

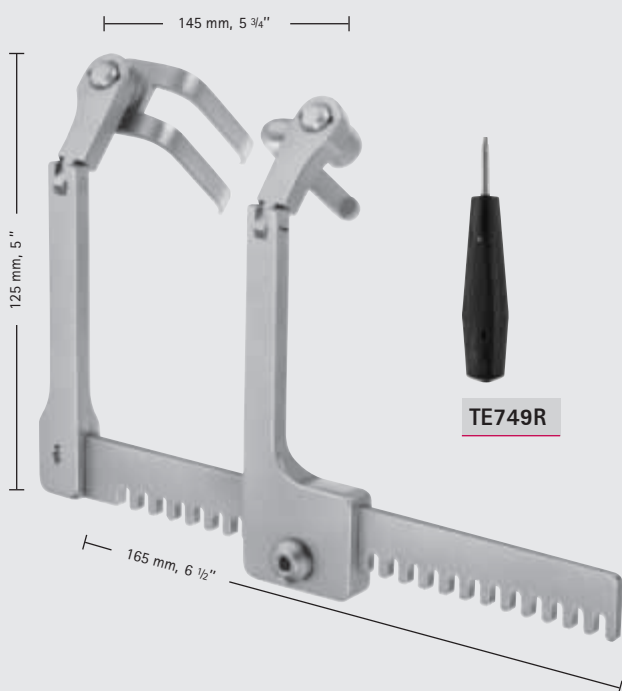

TE749R



BV435R

Haken
Hook
38 mm



BV437R

Haken
Hook
58 mm



Blätter
Blades

BV441R	32 x 22 mm
BV442R	37 x 22 mm
BV443R	42 x 22 mm
BV444R	47 x 22 mm
BV445R	52 x 22 mm
BV446R	57 x 22 mm
BV447R	62 x 22 mm
BV448R	67 x 22 mm

CASPAR

BV450R

Sperrer komplett,
für Laminektomie und Hemi-Laminektomie,
lumbal, thorakal und cervical einzusetzen
bestehend aus:

- BV449R Sperrer allein, mit Drehschlüssel TE749R
- BV435R Haken
- BV442R Blatt
- BV443R Blatt
- BV444R Blatt
- BV445R Blatt
- BV446R Blatt

Retractor complete,
for laminectomy and hemi-laminectomy,
lumbar, thoracic and cervical available
consisting of:

- BV449R Retractor only, with key TE749R
- BV435R Hook
- BV442R Blade
- BV443R Blade
- BV444R Blade
- BV445R Blade
- BV446R Blade



Blätter
Blades

BV451R	32 x 37 mm
BV452R	37 x 37 mm
BV453R	42 x 37 mm
BV454R	47 x 37 mm
BV455R	52 x 37 mm
BV456R	57 x 37 mm
BV457R	62 x 37 mm
BV458R	67 x 37 mm



Blätter
Blades

BV461R	32 x 52 mm
BV462R	37 x 52 mm
BV463R	42 x 52 mm
BV464R	47 x 52 mm
BV465R	52 x 52 mm
BV466R	57 x 52 mm
BV467R	62 x 52 mm
BV468R	67 x 52 mm



Wundspreizer, Bauchdeckenhalter – Self-Retaining Retractors, Abdominal Retractors

Universal-Wirbelsäulensperrer

Universal Retractor System

Universal-Wirbelsäulensperrer

Der selbsthaltende CASPAR-Universal-Wirbelsäulensperrer ermöglicht eine sichere Retraction und spart durch seine abnehmbaren Griffe Platz im OP-Feld.

Universal Spinal Retractor System

The self-retaining CASPAR universal spinal retractor permits safe retraction and saves space in the operation area due to the removable handles.

BV

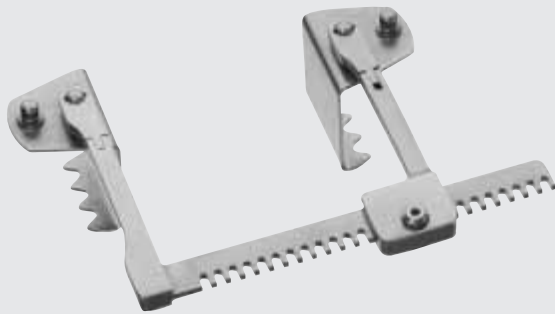

CASPAR

BV449R

Sperrer ohne Blätter

Retractor without blades



BV413R

Handgriff

Handle

Blätter
Blades

BV414R 50 x 44 mm

BV415R 50 x 54 mm

BV416R 50 x 74 mm

BV417R 50 x 89 mm

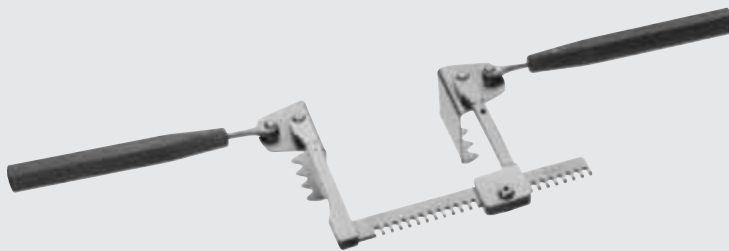

TE749R

Drehschlüssel

Key for socket-head screw

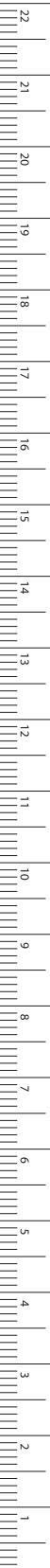

MILLIMETERS

Wundspreizer, Bauchdeckenhalter – Self-Retaining Retractors, Abdominal Retractors

Wundspreizer für cervicale Wirbelsäule

Retractors for Cervical Spine



KUGELSCHNELLVERSCHLUSS MIT VERDREHSICHERUNG

BALL SNAP CLOSURE WITH TORRSION LOCK

BV

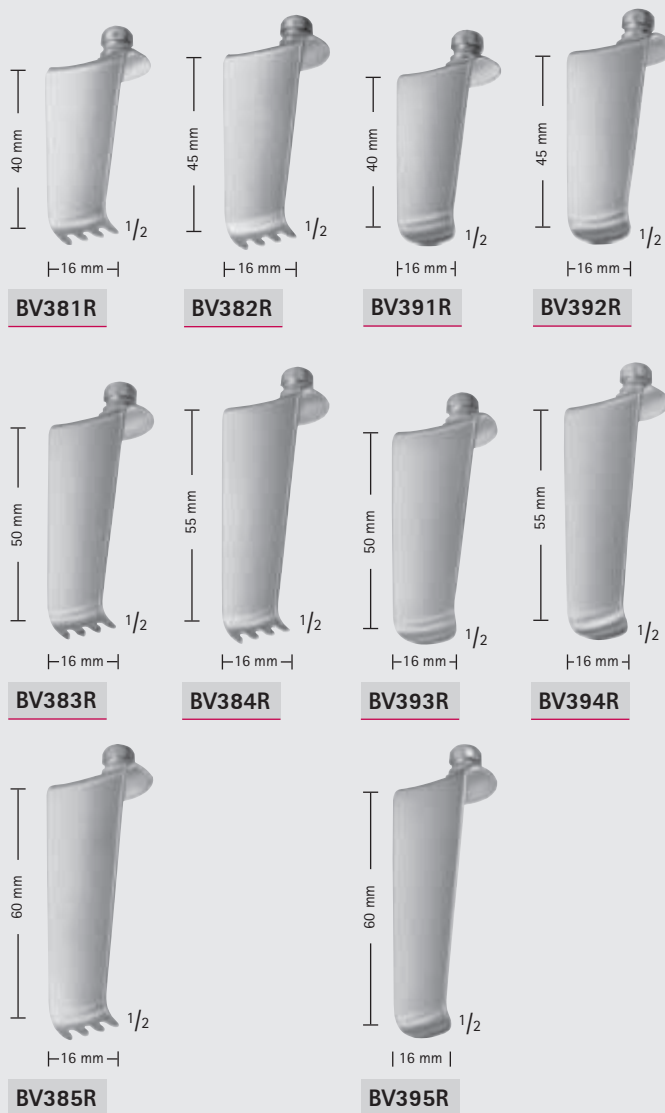

CLOWARD MODIF.

BV380R

Sperrer komplett,
bestehend aus:

- BV379R Sperrer allein
- BV381R Blatt
- BV382R Blatt
- BV383R Blatt
- BV384R Blatt
- BV385R Blatt

Retractor complete,
consisting of:

- BV379R Spreader only
- BV381R Blade
- BV382R Blade
- BV383R Blade
- BV384R Blade
- BV385R Blade

10 mm, 250 "

BV381R-BV395R

Blätter allein zu BV379R
Blades only for BV379R

INCHES



Wundspreizer, Bauchdeckenhalter – Self-Retaining Retractors, Abdominal Retractors

Wirbelkörperspreizer
Lamina Spreaders

BV

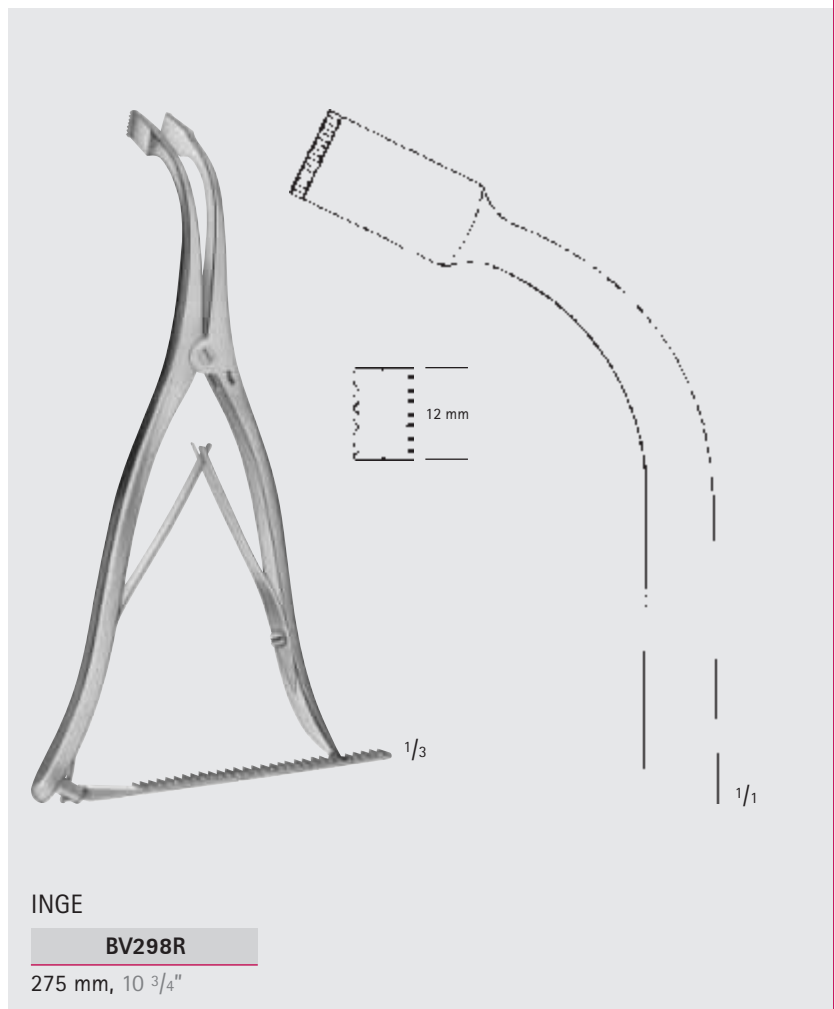
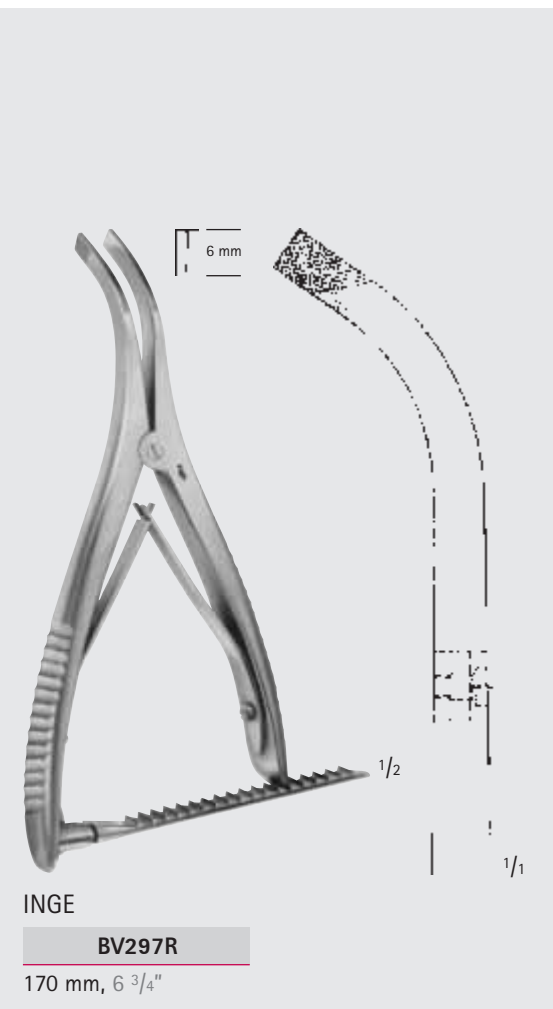
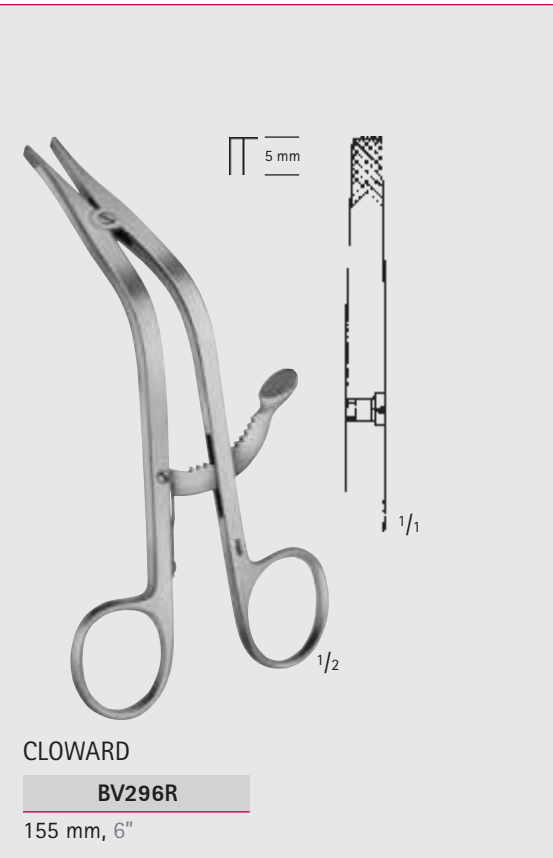

MILLIMETERS

Wundspreizer, Bauchdeckenhalter – Self-Retaining Retractors, Abdominal Retractors

Bauchdeckenhalter
Abdominal Retractors

KUGELSCHNELLVERSCHLUSS
BALL SNAP CLOSURE



BV



BABY-COLLIN

BV329R

Sperrer komplett,
bestehend aus:
BV327R Sperrer allein
BV326R Blätter (Paar)
18 x 42 mm
BV328R Blätter (Paar)
28 x 42 mm

Retractor complete,
consisting of:
BV327R Spreader only
BV326R Blades (pair)
18 x 42 mm
BV328R Blades (pair)
28 x 42 mm

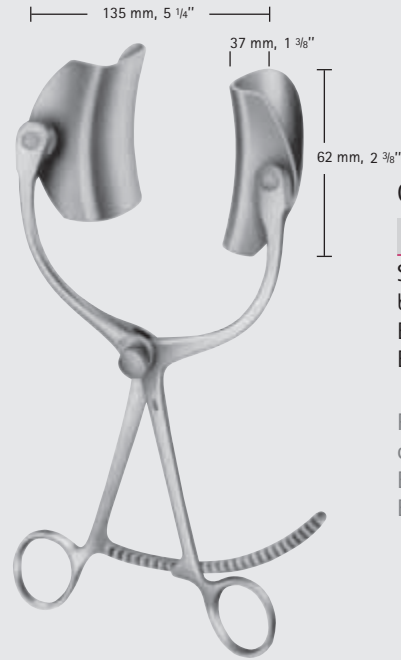

COLLIN

BV530R

Sperrer komplett,
bestehend aus:
BV520R Sperrer allein
BV551R Blätter (Paar)

Retractor complete,
consisting of:
BV520R Spreader only
BV551R Blades (pair)



COLLIN

BV531R-BV533R

komplett complete	BV531R	BV532R	BV533R
Sperrer allein Spreader only	BV522R	BV523R	BV523R
Seitl. Blätter (Paar) Lateral blades (pair)	BV551R 37 x 62 mm	BV552R 37 x 80 mm	BV553R 37 x 98 mm
Mittelblatt Center blade	BV361R 54 x 55 mm	BV362R 54 x 67 mm	BV363R 52 x 76 mm



COLLIN

BV535R-BV536R

komplett complete	BV535R	BV536R
Sperrer allein Spreader only	BV524R	BV524R
Seitl. Blätter (Paar) Lateral blades (pair)	BV555R 48 x 59 mm	BV554R 61 x 80 mm
Mittelblatt Center blade	BV338R 63 x 74 mm	BV338R 63 x 74 mm





Wundspreizer, Bauchdeckenhalter – Self-Retaining Retractors, Abdominal Retractors

KUGELSCHNELLVERSCHLUSS
BALL SNAP CLOSURE

Bauchdeckenhalter
Abdominal Retractors

BV

320 mm, 12 1/2"



RICARD

BV542R-BV543R

komplett		
complete	BV542R	BV543R
Sperrer allein	BV527R	BV527R
Spreader only		
Seitl. Blätter (Paar)	BV556R	BV557R
Lateral blades (pair)	58 x 80 mm	72 x 84 mm
Mittelblatt	BV366R	BV367R
Center blade	54 x 70 mm	72 x 90 mm

275 mm, 10 3/4"



HOLZBACH

BV545R

komplett		
complete		
Seitl. Blätter (Paar)	BV558R	
Lateral blades (pair)	59 x 80 mm	
Mittelblatt		BV369R
Center blade		74 x 82 mm

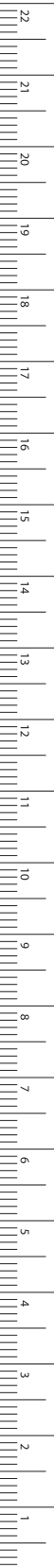

MILLIMETERS

Wundspreizer, Bauchdeckenhalter – Self-Retaining Retractors, Abdominal Retractors

Bauchdeckenvalven

Abdominal Blades



KUGELSCHNELLVERSCHLUSS
BALL SNAP CLOSURE

Bestelleinheit der Blätter: PAA = Paar

Sales unit of blades: PAA = pair

Seitliche Blätter allein

Lateral blades only



BV551R-BV553R



BV554R



BV555R-BV557R



BV558R



BV551R 37 x 62 mm

BV552R 37 x 80 mm

BV553R 37 x 98 mm



BV554R 61 x 80 mm



BV555R 48 x 59 mm

BV556R 58 x 80 mm

BV557R 72 x 84 mm



BV558R 59 x 80 mm





Wundspreizer, Bauchdeckenhalter – Self-Retaining Retractors, Abdominal Retractors

Bauchdeckenhalter
Abdominal Retractors

BV

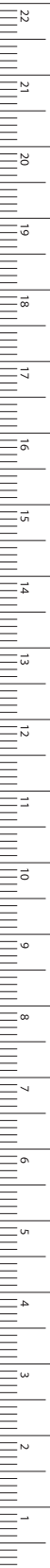

MILLIMETERS

GOSSET
BV500R
Blätter: 38 mm tief
Blades: 38 mm deep

HERTZLER
BV512R
Blätter 20 x 25 mm
Blades 20 x 25 mm

BALFOUR-BABY
BV601R
Seitl. Blätter 27 mm tief
Mittelblatt BV602R 21 x 24 mm
Lateral blades 27 mm deep
Center blade BV602R 21 x 24 mm

GOSSET
BV502R
Blätter: 55 mm tief
Blades: 55 mm deep

GOSSET
BV505R
Seitl. Blätter 58 mm tief
Mittelblatt BV506R 59 x 57 mm
Lateral blades 58 mm deep
Center blade BV506R 59 x 57 mm

Wundspreizer, Bauchdeckenhalter – Self-Retaining Retractors, Abdominal Retractors

Bauchdeckenhalter

Abdominal Retractors

BV

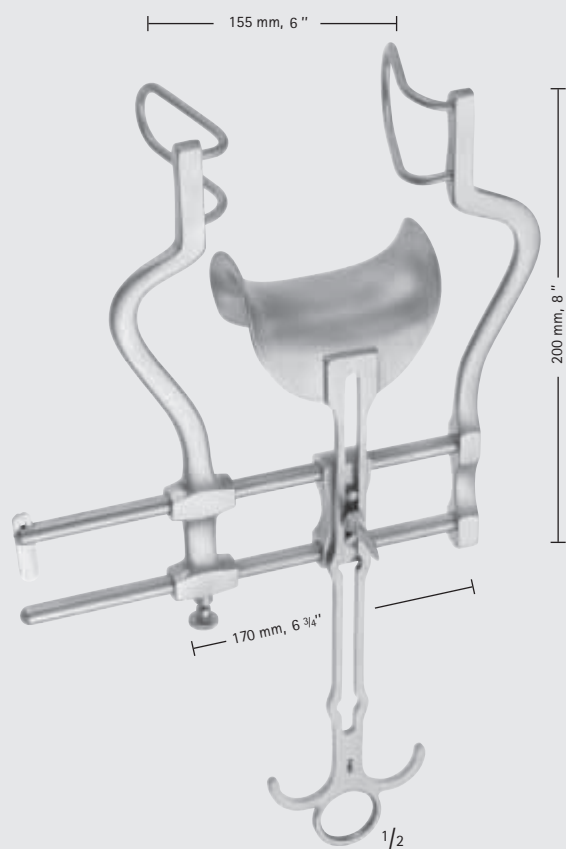

BALFOUR

BV605R

Seitl. Blätter	60 mm tief
Mittelblatt	BV606R 47 x 80 mm
Lateral blade	60 mm deep
Center blade	BV606R 47 x 80 mm

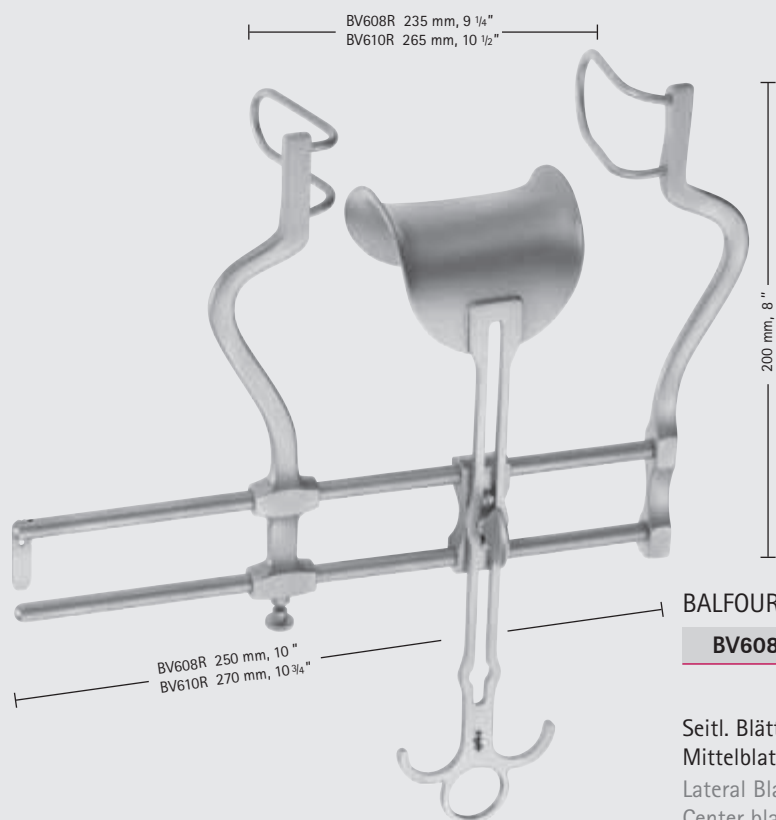

BALFOUR

BV608R-BV610R

	BV608R	BV610R
Seitl. Blätter	60 mm tief	90 mm tief
Mittelblatt	BV609R 62 x 76 mm	BV611R 80 x 80 mm
Lateral Blades	60 mm deep	90 mm deep
Center blade	BV609R 62 x 76 mm	BV611R 80 x 80 mm



Wundspreizer, Bauchdeckenhalter – Self-Retaining Retractors, Abdominal Retractors

Bauchdeckenhalter
Abdominal Retractors

BV

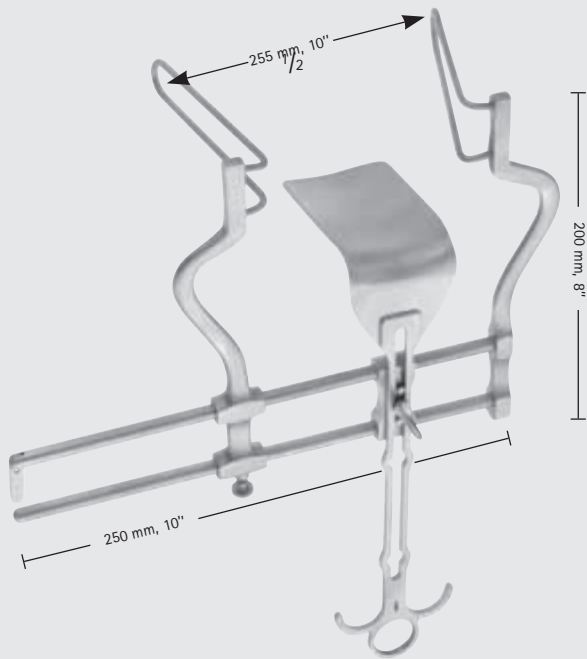

BALFOUR

BV615R

Seitl. Blätter 105 mm tief
Mittelblatt BV616R 107 x 59 mm
Lateral blades 105 mm deep
Center blade BV616R 107 x 59 mm

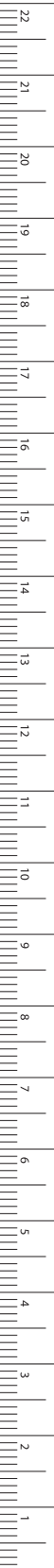

MILLIMETERS



BALFOUR

BV617R

Mittelblatt allein
Center blade only
54 x 80 mm



BV618R

Mittelblatt, geschlitzt
zur retropubischen Prostatektomie
Center blade, slotted
for retropubic prostatectomy
75 x 80 mm

Wundspreizer, Bauchdeckenhalter – Self-Retaining Retractors, Abdominal Retractors

Bauchdeckenhalter

Abdominal Retractors



KUGELSCHNELLVERSCHLUSS
BALL SNAP CLOSURE

Bestelleinheit der Blätter: PAA = Paar

Sales unit of blades: PAA = pair

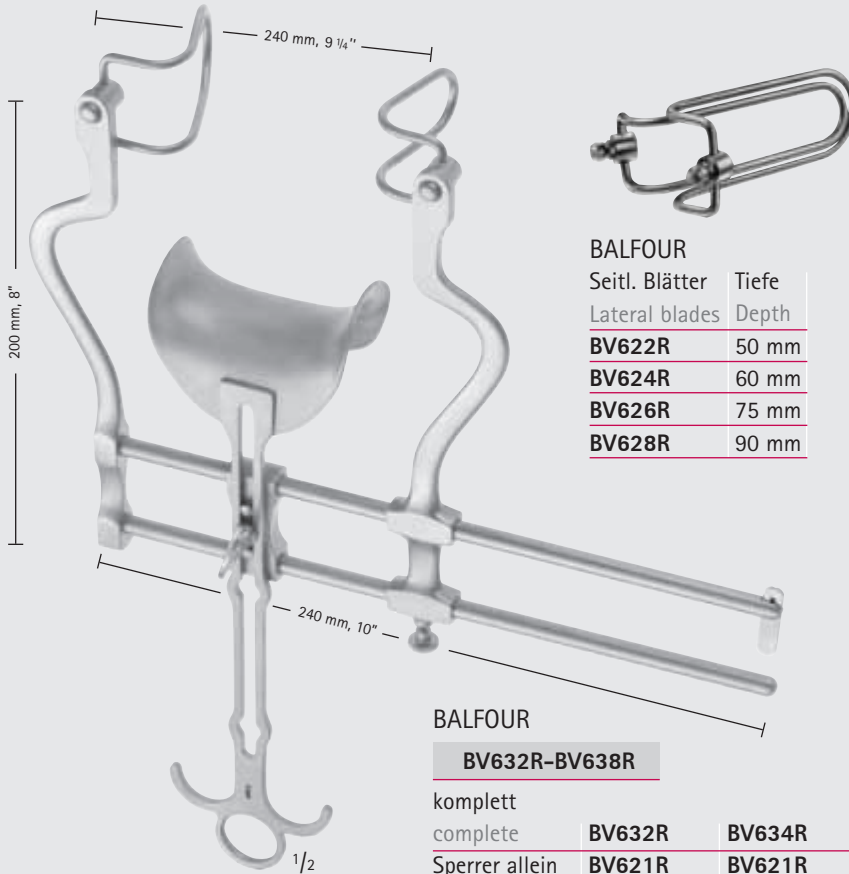

BALFOUR

Seitl. Blätter Lateral blades	Tiefe Depth
BV622R	50 mm
BV624R	60 mm
BV626R	75 mm
BV628R	90 mm

BALFOUR

BV632R-BV638R

komplett

complete	BV632R	BV634R	BV636R	BV638R
Sperrer allein Spreader only	BV621R	BV621R	BV621R	BV621R
Seitl. Blätter Lateral blades	BV622R 50 mm	BV624R 60 mm	BV626R 75 mm	BV628R 90 mm
Mittelblatt Center blade	BV606R 47 x 80 mm	BV609R 62 x 76 mm	BV611R 80 x 80 mm	BV611R 80 x 80 mm

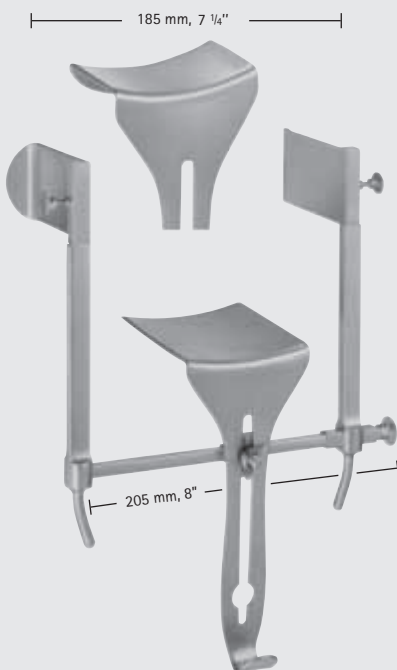

GOLIGHER

BV640R

Bauchdeckenhalter komplett,
bestehend aus:

- Mittelblatt 51 mm tief
- Mittelblatt 102 mm tief
- Seitl. Blätter (Paar) 51 mm tief
- Seitl. Blätter (Paar) 102 mm tief

Abdominal retractor complete,
consisting of:

- Center blade 51 mm deep
- Center blade 102 mm deep
- Lateral blades (pair) 51 mm deep
- Lateral blades (pair) 102 mm deep



Wundspreizer, Bauchdeckenhalter – Self-Retaining Retractors, Abdominal Retractors

Bauchdeckenhalter
Abdominal Retractors

BV



O' SULLIVAN-O' CONNOR

US100

Bauchdeckenhalter komplett,
bestehend aus:

- US100 1 Bauchdeckenhalter
- US100201 2 Blätter
- US100202 1 Blatt

Abdominal retractor complete,
consisting of:

- US100 1 Retractor
- US100201 2 Blades
- US100202 1 Blade



O'SULLIVAN-O' CONNOER

US100201

kleines Blatt
small blade



O'SULLIVAN-O' CONNOER

US100202

großes Blatt
large blade

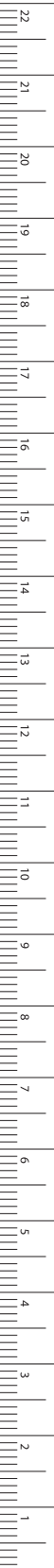

MILLIMETERS

Wundspreizer, Bauchdeckenhalter – Self-Retaining Retractors, Abdominal Retractors

Bauchdeckenhalter

Abdominal Retractors

Bauchdeckenhalter für Säuglinge und Kinder

Abdominal retractors for new-born and children

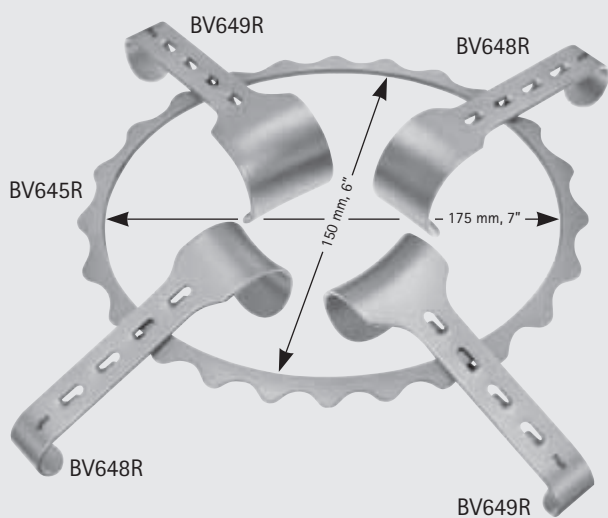

DENIS-BROWNE

BV650R

Bauchdeckenhalter komplett,
bestehend aus:

- BV645R 1 Rahmen 175 x 150 mm
- BV648R 2 Blätter allein 40 x 30 mm
- BV649R 2 Blätter allein 40 x 40 mm

Abdominal retractor complete,
consisting of:

- BV645R 1 frame 175 x 150 mm
- BV648R 2 blades only 40 x 30 mm
- BV649R 2 blades only 40 x 40 mm



DENIS-BROWNE

BV646R

Blatt allein
Blade only
20 x 30 mm



DENIS-BROWNE

BV647R

Blatt allein
Blade only
20 x 40 mm



Wundspreizer, Bauchdeckenhalter – Self-Retaining Retractors, Abdominal Retractors

Bauchdeckenhalter
Abdominal Retractors

Bauchdeckenhalter für Gynäkologen gut geeignet
Abdominal retractors well suitable for gynaecologists

BV

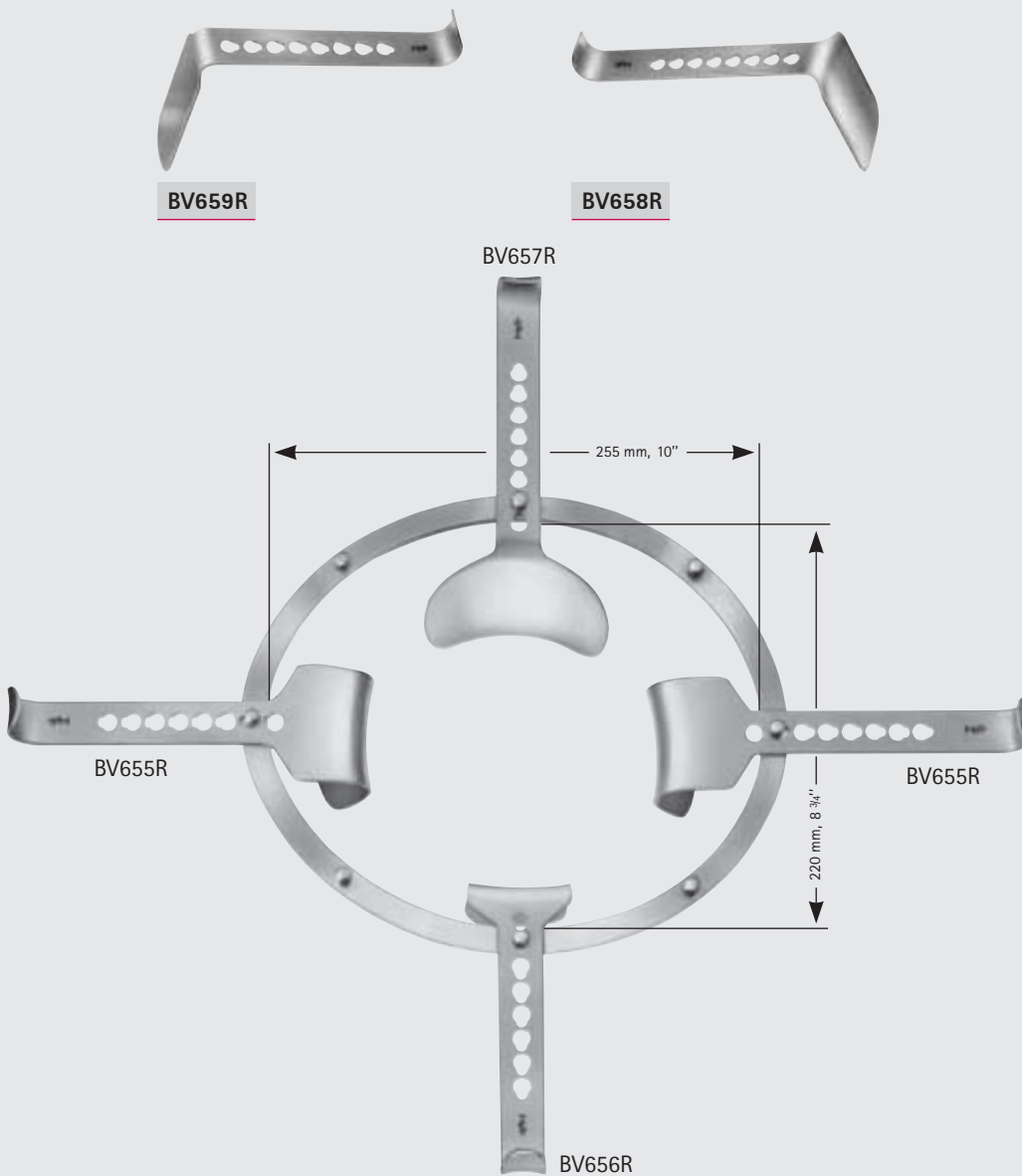

SEMM

BV654R

Bauchdeckenhalter komplett,
bestehend aus:

- BV653R 1 Rahmen 255 x 220 mm
- BV655R 2 Blätter 46 x 64 mm
- BV656R 1 Blatt 53 x 54 mm (für die Blase)
- BV657R 1 Blatt 82 x 97 mm (für den Darm)
- BV658R 1 Blatt 98 x 51 mm (für den Darm)
- BV659R 1 Blatt schmal 107 x 36 mm

Abdominal retractor complete,
consisting of:

- BV653R 1 frame 255 x 220 mm
- BV655R 2 blades 46 x 64 mm
- BV656R 1 blade 53 x 54 mm (for bladder)
- BV657R 1 blade 82 x 97 mm (for intestine)
- BV658R 1 blade 98 x 51 mm (for intestine)
- BV659R 1 blade narrow 107 x 36 mm



MILLIMETERS

Wundspreizer, Bauchdeckenhalter – Self-Retaining Retractors, Abdominal Retractors

Bauchdeckenhalter

Abdominal Retractors

BV

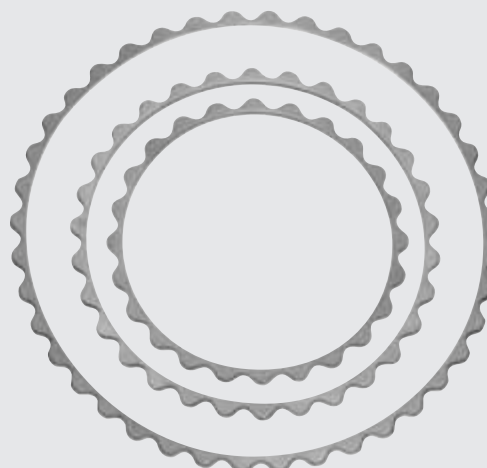

BV686R

ø 180 mm
diam 7"

BV687R

ø 230 mm
diam. 9"

BV688R

ø 305 mm
diam. 12"

TURNER-WARWICK

BV686R

Bauchdeckenrahmen, rund
Retractor frame, round

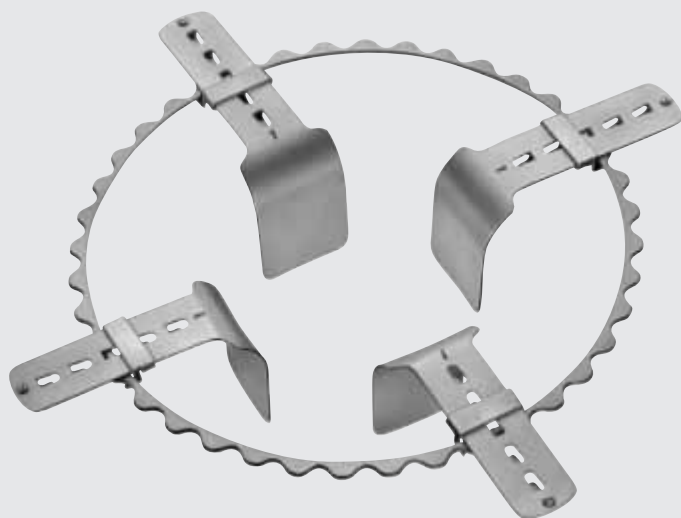

TURNER-WARWICK

BV685R

Bauchdeckenhalter komplett,
bestehend aus:

BV686R - BV688R	je 1 Rahmen
BV690R - BV693R	je 2 Bauchdeckenspatel
BV694R - BV695R	je 2 Bauchdeckenhaken
BV696R - BV697R	je 2 Bauchdeckenhaken
BV698R	2 Einzinkerhaken

Abdominal retractor complete,
consisting of:

BV686R - BV688R	1 Frame of each
BV690R - BV693R	2 Retractor blades of each
BV694R - BV695R	2 Abdominal retractors of each
BV696R - BV697R	2 Abdominal retractors of each
BV698R	2 Retractor blade single hooks



TURNER-WARWICK

BV689R

Bauchdeckenrahmen, oval
Retractor frame, oval
457 x 330 mm,



Wundspreizer, Bauchdeckenhalter – Self-Retaining Retractors, Abdominal Retractors

Bauchdeckenhalter
Abdominal Retractors

BV

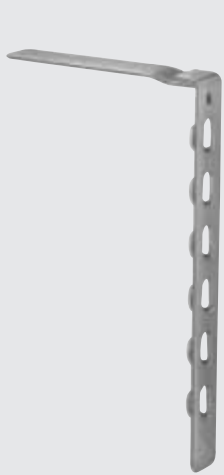

BV690R

biegsam
malleable
76 x 19 mm



BV691R

biegsam
malleable
102 x 38 mm

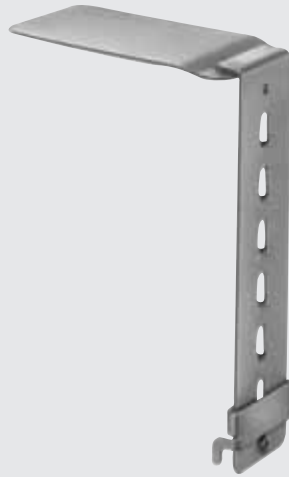

BV692R

biegsam
malleable
89 x 57 mm

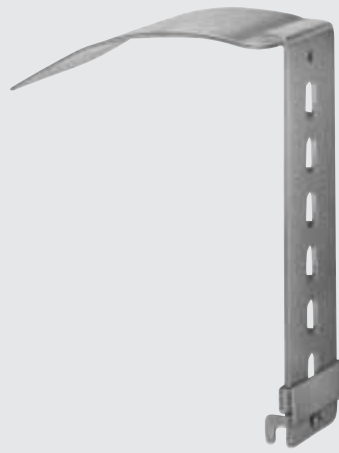

BV693R

biegsam
malleable
114 x 57 mm



BV694R

51 x 38 mm



BV695R

76 x 60 mm



BV696R

89 x 60 mm

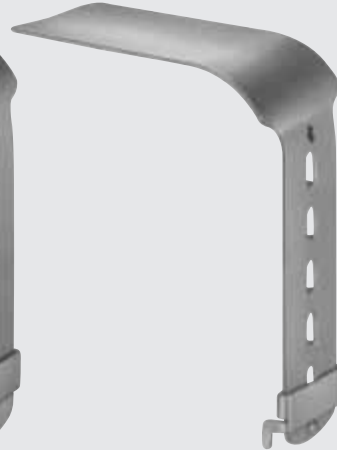

BV697R

114 x 60 mm



BV698R

13 mm tief
13 mm deep

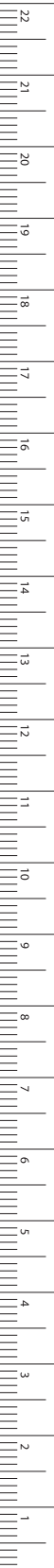

MILLIMETERS

Wundspreizer, Bauchdeckenhalter – Self-Retaining Retractors, Abdominal Retractors

Bauchdeckenhalter

Abdominal Retractors

BV



250 x 250 mm, 10 x 10"

KIRSCHNER

BV662R

Bauchdeckenhalter komplett, bestehend aus:

- BV663R 1 Rahmen, zusammenlegbar
- BV668R 2 Blätter
- BV669R 2 Blätter

Abdominal retractor complete, consisting of:

- BV663R 1 Holding frame
- BV668R 2 Blades
- BV669R 2 Blades

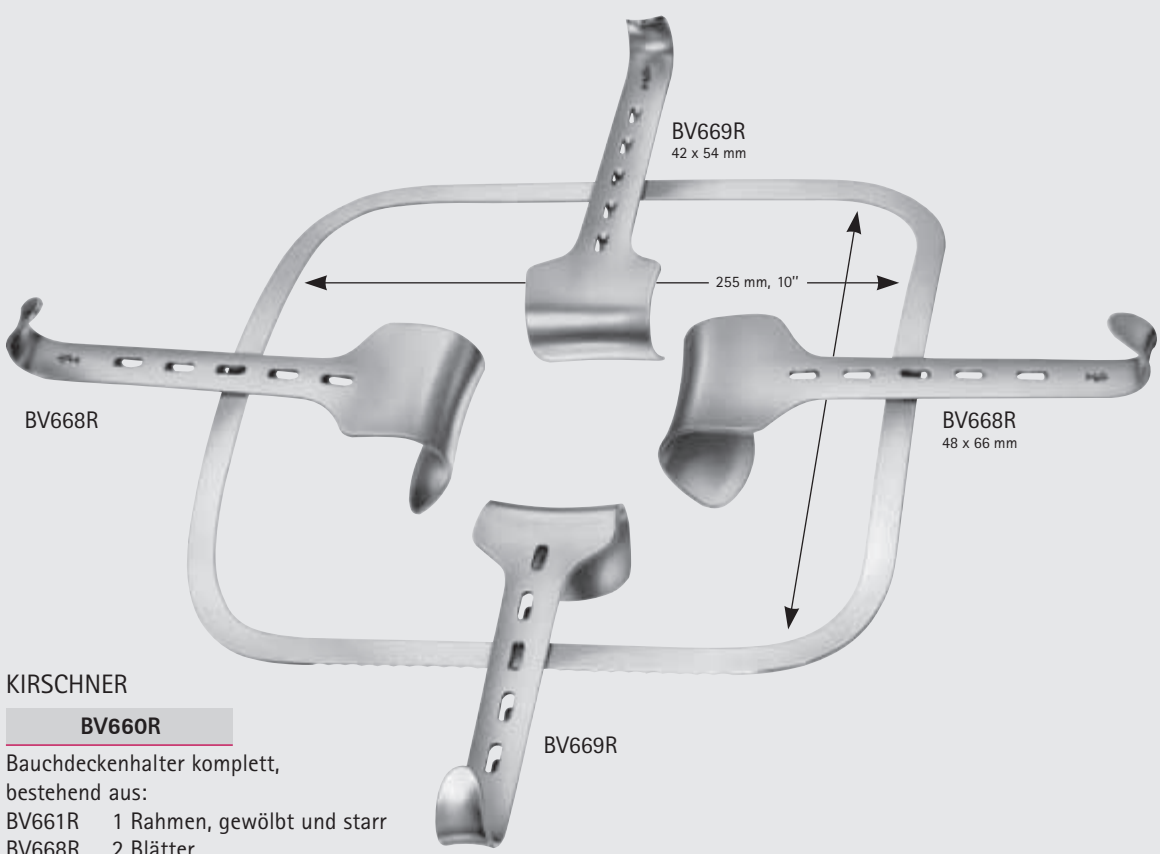

BV669R
42 x 54 mm

255 mm, 10"

BV668R

BV668R
48 x 66 mm

BV669R

KIRSCHNER

BV660R

Bauchdeckenhalter komplett, bestehend aus:

- BV661R 1 Rahmen, gewölbt und starr
- BV668R 2 Blätter
- BV669R 2 Blätter

Abdominal retractor complete, consisting of:

- BV661R 1 Vaulted fixed frame
- BV668R 2 Blades
- BV669R 2 Blades

KIRSCHNER

BV664R

Rahmen allein, übergroß
Frame only, over-sized
275 x 355 mm

KIRSCHNER

BV665R

Rahmen allein
Frame only
295 x 275 mm



Wundspreizer, Bauchdeckenhalter – Self-Retaining Retractors, Abdominal Retractors

Bauchdeckenhalter
Abdominal Retractors

Zusätzliche Blätter für Fettleibige
Additional valves for corpulent persons

BV



KIRSCHNER

BV670R

64 x 80 mm



KIRSCHNER-BALFOUR

BV672R

80 x 82 mm



KIRSCHNER

BV674R 90 x 69 mm

BV675R 95 x 95 mm

BV676R 78 x 58 mm



KIRSCHNER

BV680R 108 x 42 mm

BV682R 91 x 55 mm

BV684R 120 x 55 mm



MILLIMETERS

Wundspreizer, Bauchdeckenhalter – Self-Retaining Retractors, Abdominal Retractors

Blasenwundspreizer

Bladder Retractors



KUGELSCHNELLVERSCHLUSS
BALL SNAP CLOSURE

BV



BV576R



100 mm, 4"

BV577R

MILLIN

BV580R

Blasenwundspreizer komplett,
bestehend aus:

- BV575R Sperrer allein
- BV576R Blätter 57 x 25 mm
- BV577R Blätter 82 x 25 mm
- BV578R Mittelblatt 105 x 45 mm

Bladder retractor complete,
consisting of:

- BV575R Spreader only
- BV576R Blades 57 x 25 mm
- BV577R Blades 82 x 25 mm
- BV578R Center blade 105 x 45 mm

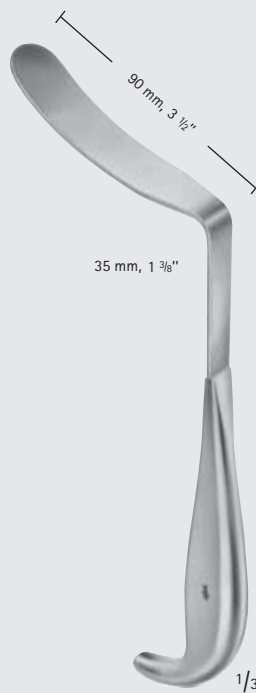

90 mm, 3 1/2"

35 mm, 1 3/8"

1/3

LEGUEU

BV928R

Blasenspatel

Bladder spatula

260 mm, 10 1/4"



Wundspreizer, Bauchdeckenhalter – Self-Retaining Retractors, Abdominal Retractors

Poplitea-Sperrer
Poplitea Retractor

BV

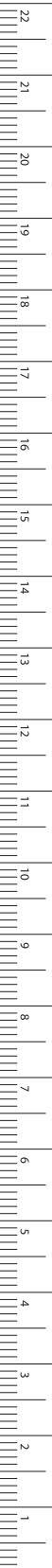

MILLIMETERS



BV348R

Blätter (Paar), allein
bestehend aus:
Blatt, stumpf, 60 x 50 mm
Blatt, halbscharf, 40 x 35 mm
Blades (pair), only
consisting of:
Blade, blunt, 60 x 50 mm
Blade, semi-sharp, 40 x 35 mm

BV349R

Poplitea-Sperrer, komplett
bestehend aus:
BV327R Sperrer allein
BV348R Blätter (Paar)
Poplitea retractor, complete
consisting of:
BV327R Retractor only
BV348R Blades (pair)

„Einer für Alle“
"One for All"



Ein System für alle Indikationen in

- Viszeralchirurgie
- Urologie
- Gynäkologie
- Abdominale Gefäßchirurgie

Eine Vielzahl an Rahmen, Klemmen, Stangen und Wundhaken ermöglicht es, ein individuell angepasstes Retraktions-System zusammenzustellen, welches praktisch keine Wünsche mehr offen lässt.

One system for all indications in

- Visceral surgery
- Urology
- Gynaecology
- Abdominal vascular surgery

The multiplicity of different frames, clamps, rods and retractors permits an individually adjustable retraction system which corresponds to the needs of the customers.





Wundspreizer, Bauchdeckenhalter – Self-Retaining Retractors, Abdominal Retractors

Retraktions-System MÜNSTER
MÜNSTER Retraction System

BV

universell, flexibel, sicher, einfach in der Handhabung
universal, safe, easy to use

Weitere Informationen finden
Sie in unserem Prospekt **C216**.

For further details see
brochure No. **C216**.

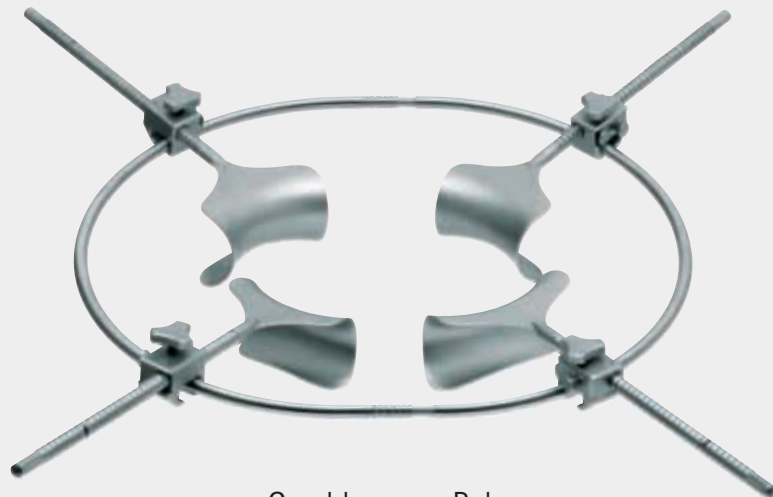

Geschlossener Rahmen
Closed frame



Offener Rahmen
Open frame

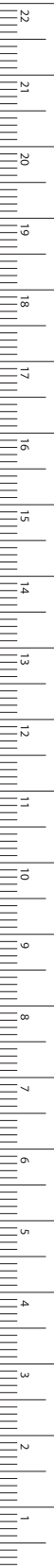

MILLIMETERS

Das Mini Retraktionssystem

The Mini Retraction System



Das Retraktionssystem FRANKFURT ist ein universelles Mini Retraktionssystem.

Die Position der Wundhaken auf den Rahmen kann frei gewählt werden. Die Wundhaken sind durch spezielle Befestigungsklemmen mit den Rahmen verbunden und können in allen Dimensionen bewegt werden.

The FRANKFURT retraction system is a universal mini retraction system.

The retractors can be positioned anywhere on the frame. The retractors are fixed to the frame with special fixation clamps and can be moved in any direction and in all dimensions.





Wundspreizer, Bauchdeckenhalter – Self-Retaining Retractors, Abdominal Retractors

Retraktions-System FRANKFURT FRANKFURT Retraction System

BV

Weitere Informationen finden
Sie in unserem Prospekt **C779**.

For further details see
brochure No. **C779**.



Für die Kinderchirurgie
For Pediatric Surgery

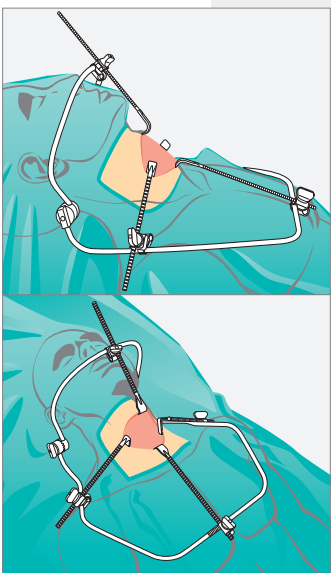

Für Struma Operationen
For Thyroid Operations

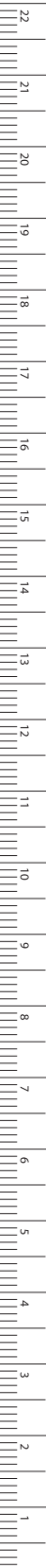

MILLIMETERS

Wundspreizer, Bauchdeckenhalter – Self-Retaining Retractors, Abdominal Retractors

UNITRAC® - Retraktions- und Haltesystem

UNITRAC® - Retraction- and Holding System

BV

Retraktion in Perfektion

Retraction in Perfection



Das Retraktions- und Haltesystem für die

- Offene Chirurgie
- Minimalinvasive Chirurgie
- Orthopädie
- Traumatologie

The retraction and holding system for

- Open Surgery
- Minimal Invasive Surgery
- Orthopaedics
- Traumatology





Wundspreizer, Bauchdeckenhalter – Self-Retaining Retractors, Abdominal Retractors UNITRAC® - Retraktions- und Haltesystem UNITRAC® - Retraction- and Holding System



- ⌘ Universell einsetzbar zum Halten von Wundhaken, Kameras und Endoskopen
Universal use for holding hooks, retractors, cameras and endoscopes
- ⌘ Umfangreiches Zubehör an Wundhaken, Kamera- und Endoskophaltern verfügbar
Extensive range of blades, hooks, camera and endoscope holders available
- ⌘ Pneumatisch unterstütztes System zum direkten Anschluss an die vorhandene OP-Druckluftversorgung
Pneumatically supported system for direct connection with the compressed air supply in the operating room
- Betriebsdruck: 5,5 bar bis 12 bar
Required working pressure: 5.5 bar up to 12 bar
- ⌘ Einfache Montage an die OP-Tischschiene
Easy to attach to operating room table
- ⌘ Schnelle und sterile Bereitstellung im OP
Quick sterile set-up in operating room
- ⌘ Dampfsterilisierbar bei 134 °C (2 bar)
Autoclaveable at 134 °C (2 bar)

Weitere Informationen finden Sie in unserem Prospekt **C474**.

For further details see brochure No. **C474**.

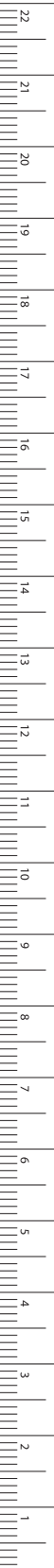

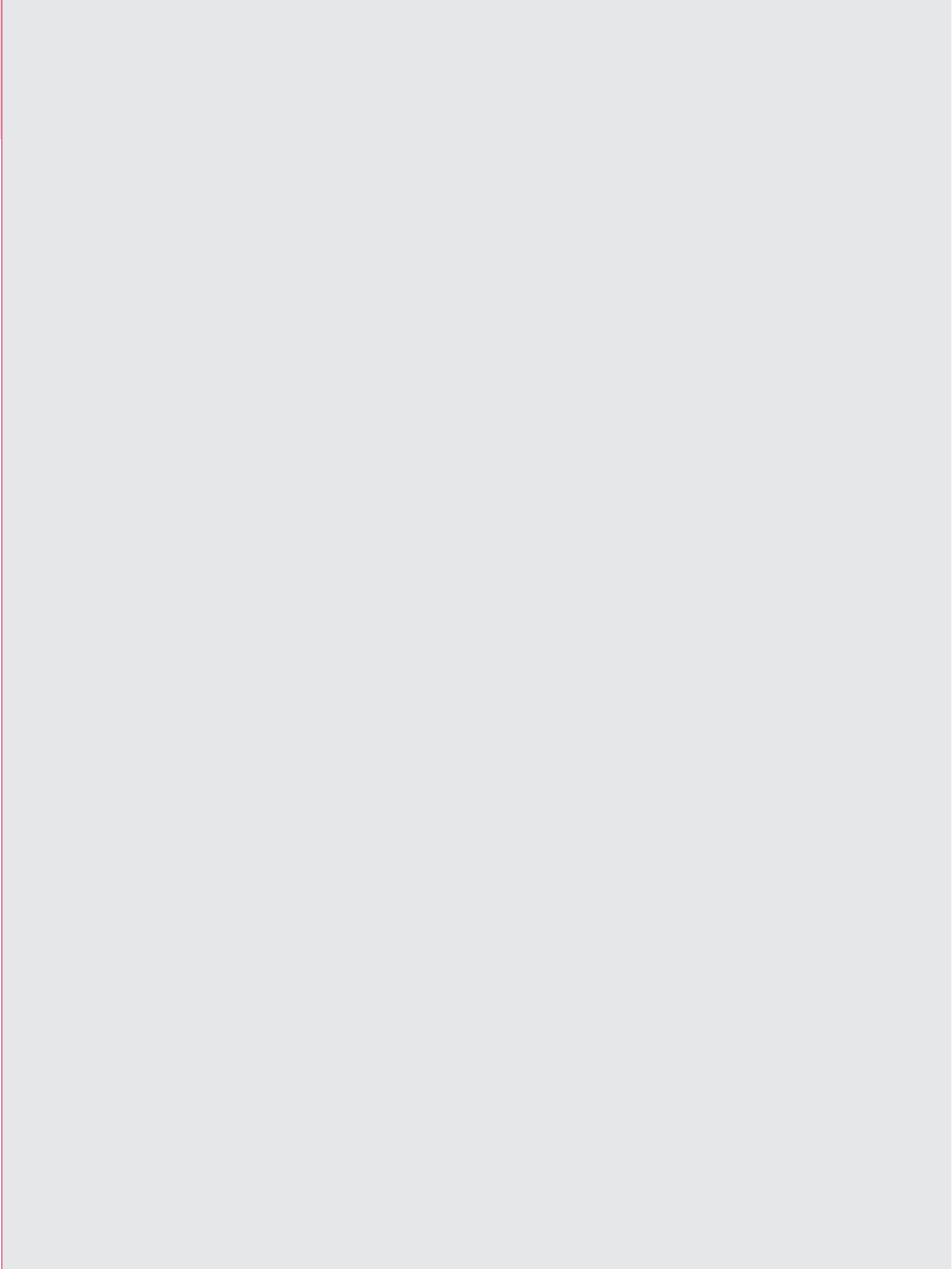

GK



Elektrochirurgie
Electrosurgery

Elektrochirurgie – Electro Surgery

Elektrodenhandgriffe

Electrode Handles

MONOPOLAR

passend für Geräte von Aesculap, ACMI, Berchtold, Martin, Erbe ACC/ICC/IO
suitable for devices from Aesculap, ACMI, Berchtold, Martin, Erbe ACC/ICC/IO



GN209

Elektrodenhandgriff, mit Doppelfingertastern
Electrode handle, with two finger pushbuttons



GN207

Elektrodenhandgriff, ohne Fingertaster
Electrode handle, without finger pushbuttons

passend für Geräte von Aesculap, ACMI, Berchtold, Martin
suitable for devices from Aesculap, ACMI, Berchtold, Martin



GN203-GN205

Kabel für Elektrodenhandgriff
Cable for electrode handle

GN203	GN205
3,5 m	5,0 m

passend für Geräte von Erbe ACC/ICC/IO
suitable for devices from Erbe ACC/ICC/IO



GN213-GN215

Kabel für Elektrodenhandgriff
Cable for electrode handle

GN213	GN215
3,0 m	5,0 m

GK





Elektrochirurgie – Electro Surgery

Elektrodenhandgriffe

Electrode Handles

MONOPOLAR

passend für Geräte von Aesculap, ACMI, Berchtold, Conmed, Martin, Valleylab
suitable for devices from Aesculap, ACMI, Berchtold, Conmed, Martin, Valleylab



GK252Y

Elektrodenhandgriff ohne Fingertaster, Stecker US-Norm
Electrode handle, without finger pushbuttons, plug according to US standard



GK253Y

Elektrodenhandgriff mit Doppelfingertastern, Stecker US-Norm
Electrode handle, with two finger pushbuttons, plug according to US standard

passend für Geräte von Aesculap, ACMI, Berchtold, Martin
suitable for devices from Aesculap, ACMI, Berchtold, Martin

Slim Style



GN206

Elektrodenhandgriff, ohne Fingertaster
Electrode handle, without finger pushbuttons

Slim Style



GN218

Elektrodenhandgriff, ohne Fingertaster
Electrode handle, without finger pushbuttons

Slim Style



GN208

Elektrodenhandgriff, ohne Fingertaster
Electrode handle, without finger pushbuttons

GK

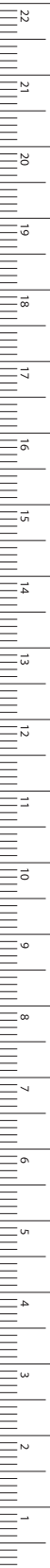

MILLIMETERS

Elektrochirurgie – Electro Surgery

Elektrodenhandgriffe

Electrode Handles

MONOPOLAR

passend für Geräte von Aesculap, ACMI, Berchtold, Conmed, Martin, Valleylab
suitable for devices from Aesculap, ACMI, Berchtold, Conmed, Martin, Valleylab

Slim Style



GN210-GN212

Elektrodenhandgriff mit Doppelfingertastern, Stecker US-Norm

Electrode handle, with two finger pushbuttons, plug according to US standard

	GN210	GN212
ø	2,4 mm	4,0 mm
diam.	2.0 mm	4.0 mm

Single Use



GN211

Einmal-Elektrodenhandgriff, mit Fingertastern, Stecker US Norm

Single use electrode handle, with finger pushbuttons, plug according to US standard

Single Use



GN221

Einmal-Elektrodenhandgriff, ohne Fingertaster

Single use electrode handle, without finger pushbuttons

Single Use

Elektrodenhandgriffe

Electrodes handles

Bestelleinheit:

PAK = Packung à 50 Stück, einzeln steril verpackt

Sales unit:

PAK = Package of 50 pieces, in individual sterile packs



Elektrochirurgie – Electro Surgery







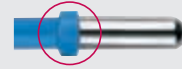

Kurze Arbeitselektroden

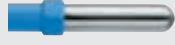
Short Working Electrodes

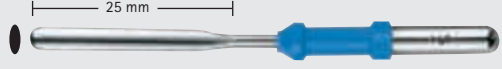
MONOPOLAR

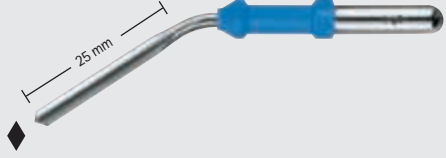
mit Sechskantverdrehschutz
with hexagonal anti-twist protection

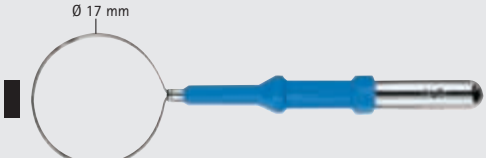

		ø 4,0 mm diam. 4.0 mm	ø 2,4 mm diam. 2.4 mm
Messerelektroden Knife electrodes		 GK110R	 GK140R
Lanzettenelektroden Cutting electrodes		GK111R	GK141R
		GK112R	GK142R
		GK113R	GK143R
Nadelelektroden Needle electrodes		GK114R	GK144R
Schlingenelektroden Loop electrodes		GK115R	GK145R
		GK116R	GK146R
		GK117R	GK147R
		GK118R	GK148R

GK

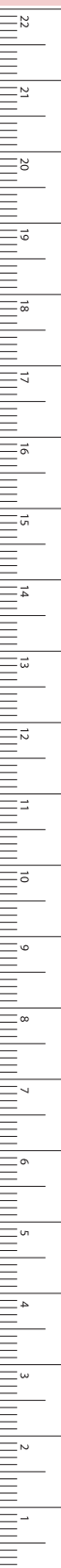

MILLIMETERS

Elektrochirurgie – Electro Surgery

Kurze Arbeitselektroden
Short Working Electrodes

MONOPOLAR

mit Sechskantverdreheschutz
with hexagonal anti-twist protection

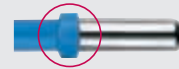

ø 4,0 mm
diam. 4.0 mm



ø 2,4 mm
diam. 2.4 mm



Kugelelektroden
Ball electrodes



GK121R

GK151R



GK122R

GK152R

Plattenelektroden
Plate electrodes

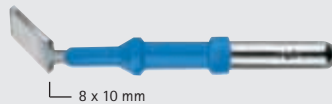

GK123R

GK153R

Chirurgie-Elektroden-Set
bestehend aus:
Behälter, Ständer
und 12 Elektroden
Surgical electrodes set
consisting of:
container, rack
and 12 electrodes



GK174R

Single Use

Kugelelektrode
Ball electrode

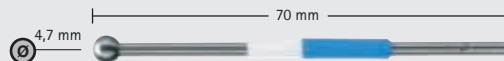

GK164R

Single Use

Nadelelektrode
Needle electrode

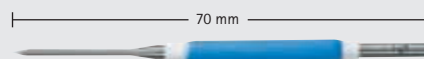

GK165R

Single Use

Elektrodenhandgriffe
Electrodes handles

Bestelleinheit:

PAK = Packung à 50 Stück, einzeln steril verpackt

Sales unit:

PAK = Package of 50 pieces, in individual sterile packs



Elektrochirurgie – Electro Surgery

Isolierte Langschattelektroden

Insulated Long-Shank Electrodes

MONOPOLAR

mit Sechskantverdrehenschutz
with hexagonal anti-twist protection

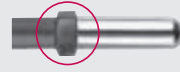

GK

ø 4,0 mm
diam. 4.0 mm



ø 2,4 mm
diam. 2.4 mm

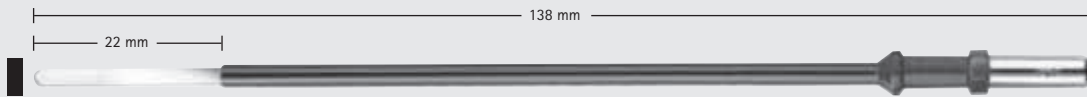

Messerelektroden
Knife electrodes

GK125R

GK155R

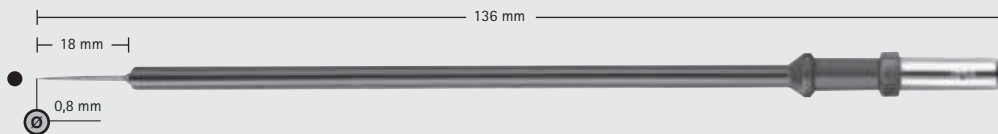

Nadelelektroden
Needle electrodes

GK127R

GK157R

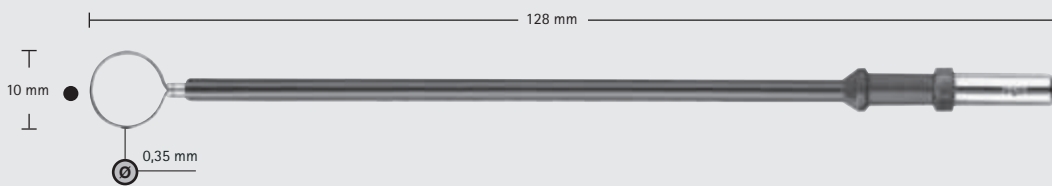

Drahtschlingenelektrode
Wire loop electrode

GK128R

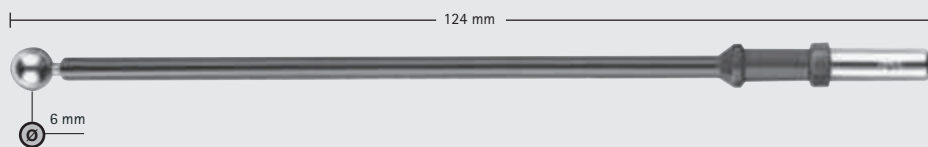

Kugelelektrode
Ball electrode

GK129R



MILLIMETERS

Elektrochirurgie – Electro Surgery

Isolierte Langschaftelektroden

Insulated Long-Shank Electrodes

MONOPOLAR

mit Sechskantverdrehschutz
with hexagonal anti-twist protection

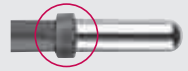

ø 4,0 mm
diam. 4.0 mm

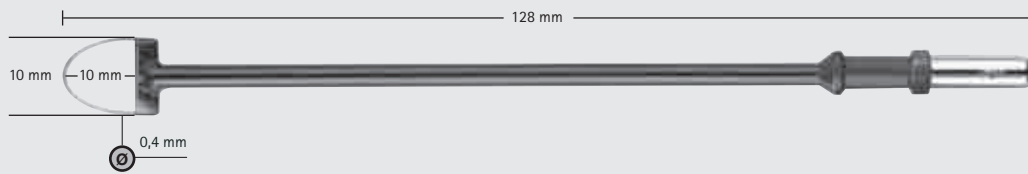

GK131R

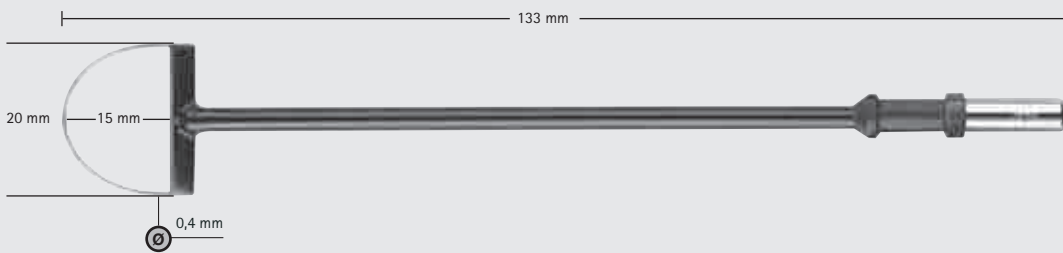

GK132R

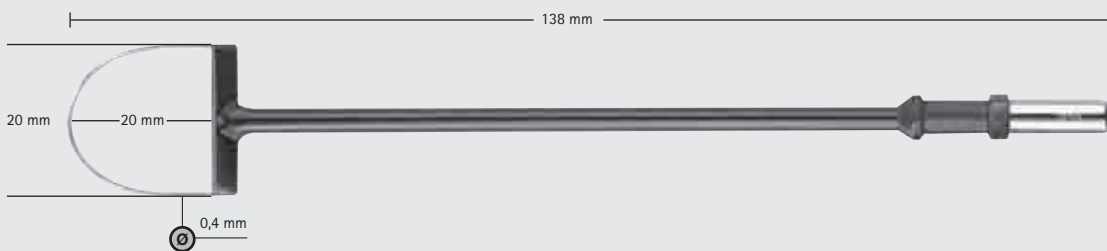

GK133R

GK131R-GK133R

Drahtschlingenelektroden zur Konisation der Portio

Wire loop electrodes for conization of the portio

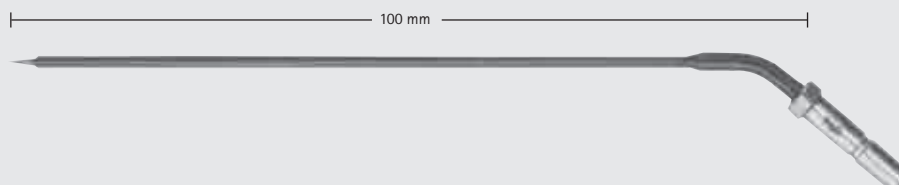

GK424

Stichkoagulationsnadel für die Nasenmuschel
Needle electrode for nasal concha

GK





MONOPOLAR

GK



GN227

Elektrodenhandgriff, ohne Fingertaster
Electrode handle, without finger pushbuttons



GN229

Elektrodenhandgriff, mit Doppelfingertastern
Electrode handle, with two finger pushbuttons

passend für Geräte von Aesculap, ACMI, Berchtold, Martin
suitable for devices from Aesculap, ACMI, Berchtold, Martin

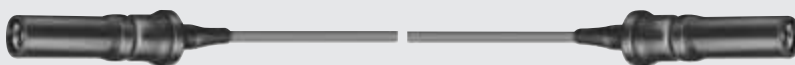

GN203-GN205

Kabel für Elektrodenhandgriff
Cable for electrode handle

GN203	GN205
3,5 m	5,0 m



MILLIMETERS

Elektrochirurgie – Electro Surgery

Mikro-Chirurgie

Micro Surgery

MONOPOLAR

GK

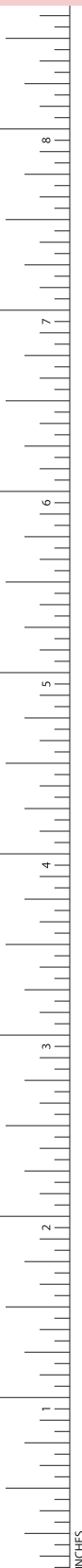

ø 1,7 mm
diam. 1.7 mm



GK301R

GK303R

GK305R

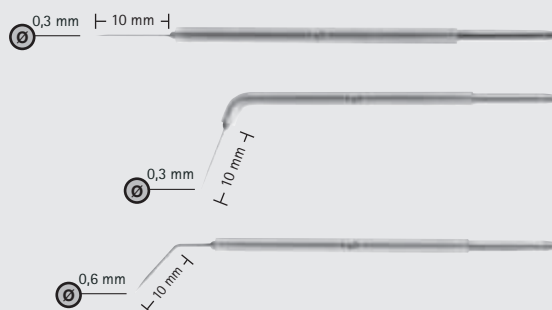

GK301R-GK305R

Nadelelektroden
Needle electrodes

GK307R

GK310R

GK315R

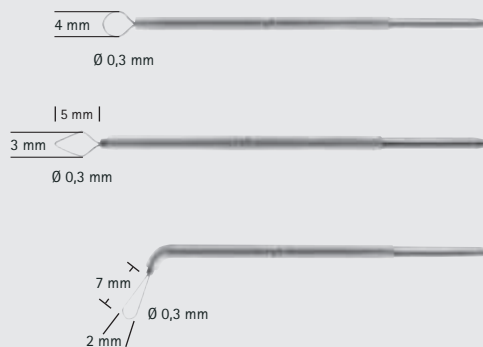

GK307R-GK315R

Schlingenelektroden
Loop electrodes

GK320R

GK321R

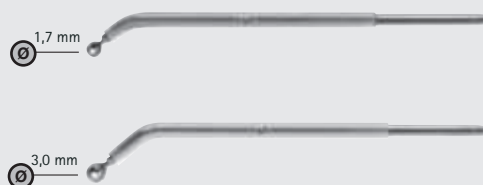

GK320R-GK321R

Kugelelektroden
Ball electrodes

GK680R

Behälter mit Deckel
Container with lid

GK681R

Ständer für Mikro-Elektroden
Rack for micro electrodes

GK683R

Ständer für Chirurgie-Elektroden
Rack for surgery electrodes





Elektrochirurgie – Electro Surgery
Schleimhautnadel, Schere, isoliert
Mucosa Needle, Scissors, Insulated

MONOPOLAR

GK



ABBEY

OL189R

Schleimhautnadel

Mucosa needle



BC608R

Schere, isoliert

Scissors, insulated

200 mm, 8'''

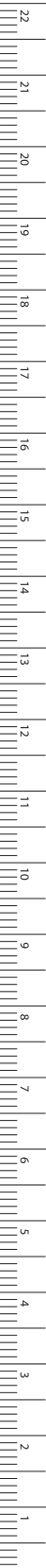

MILLIMETERS

Elektrochirurgie – Electro Surgery

Pinzetten, isoliert
Forceps, Insulated

MONOPOLAR

GK

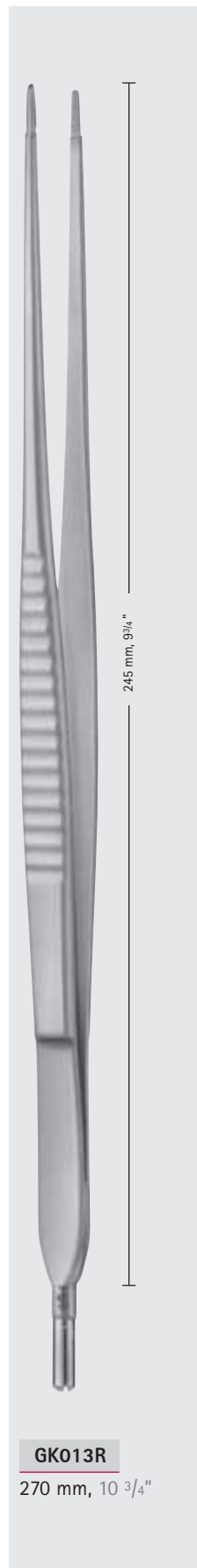
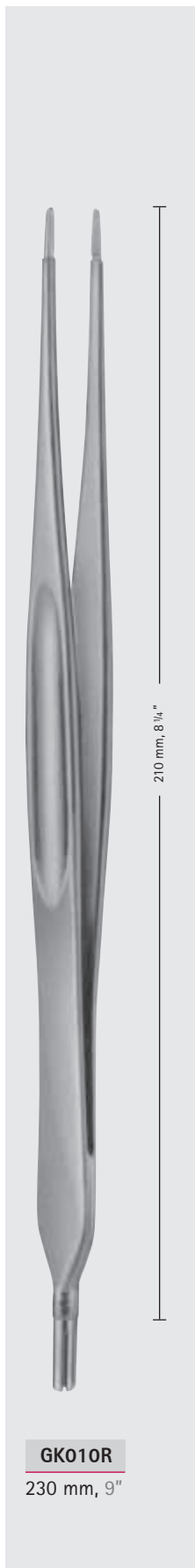
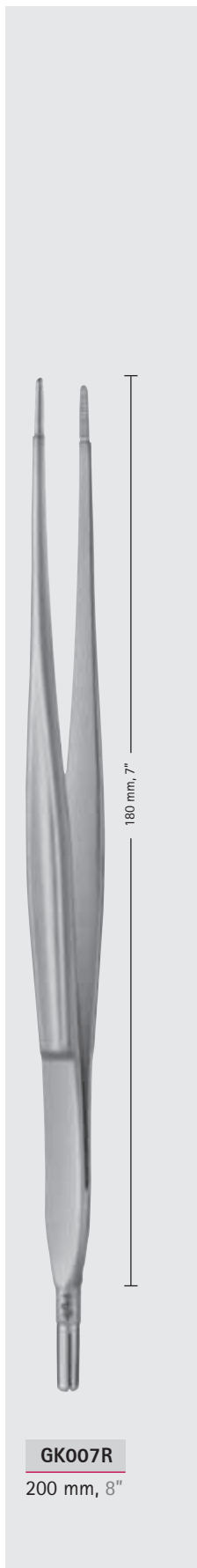
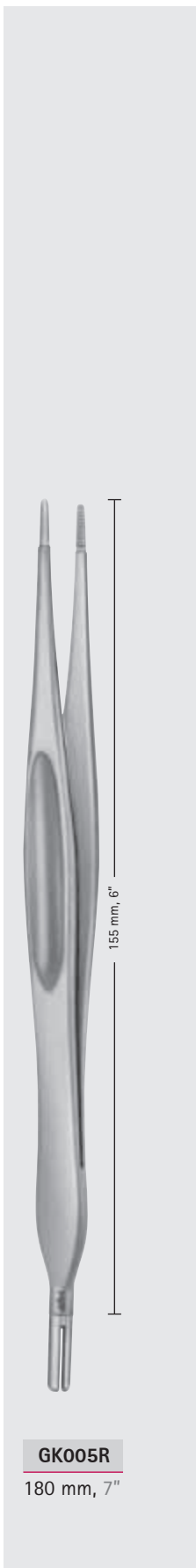
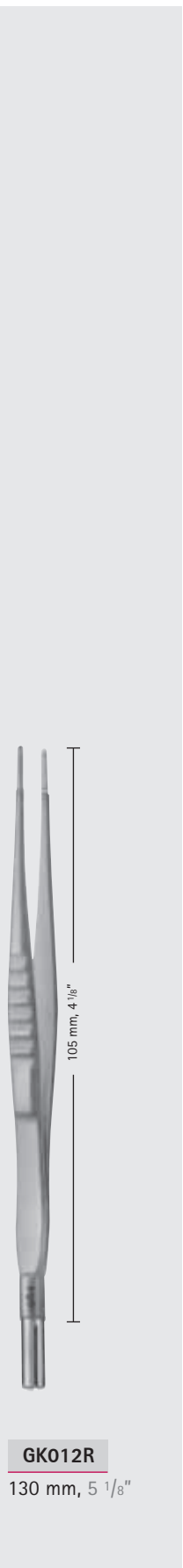



Elektrochirurgie – Electro Surgery
 Pinzetten, isoliert
 Forceps, Insulated

MONOPOLAR



GK

<p>ADSON GK015R 150 mm, 6"</p>	<p>GILLES GK006R 1 x 2 Zähne 1 x 2 teeth 170 mm, 6 3/4"</p>	<p>TURNER GK008R 130 mm, 5 1/8"</p>	<p>MC INDOE GK009R 175 mm, 7"</p>	<p>WAUGH GK016R 230 mm, 9"</p>	<p>WAUGH GK017R 1 x 2 Zähne 1 x 2 teeth 230 mm, 9"</p>



MILLIMETERS

Elektrochirurgie – Electro Surgery

Pinzetten, isoliert
Forceps, Insulated

MONOPOLAR

GK

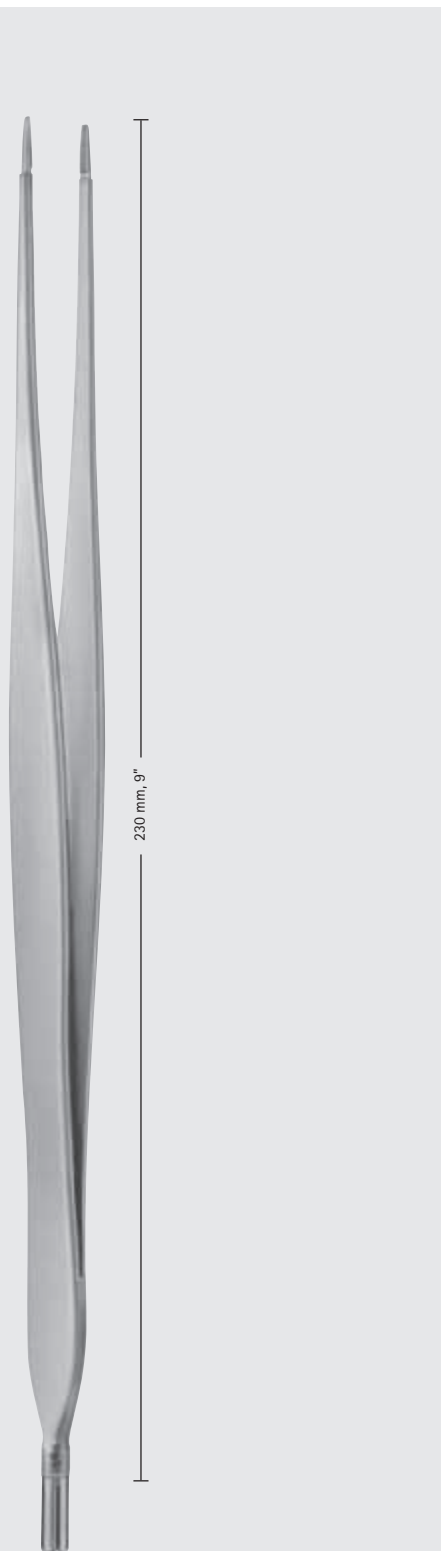

REMINGTON-HOBB
GK737R

250 mm, 10"

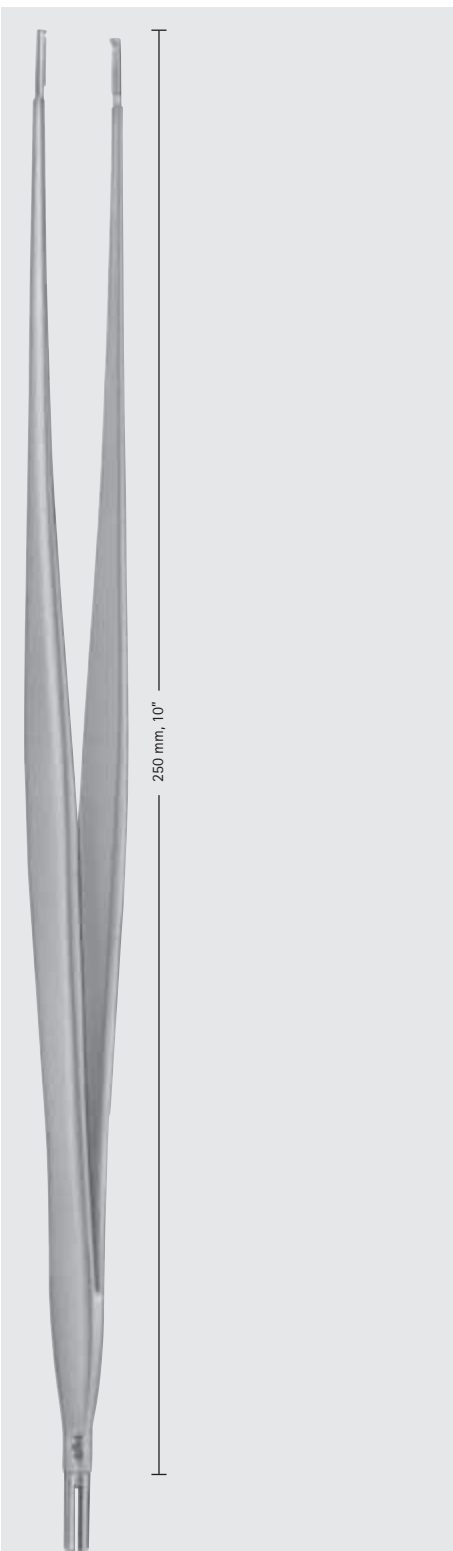

REMINGTON-HOBB
GK738R

1 x 2 Zähne
1 x 2 teeth
270 mm, 10 ³/₄"

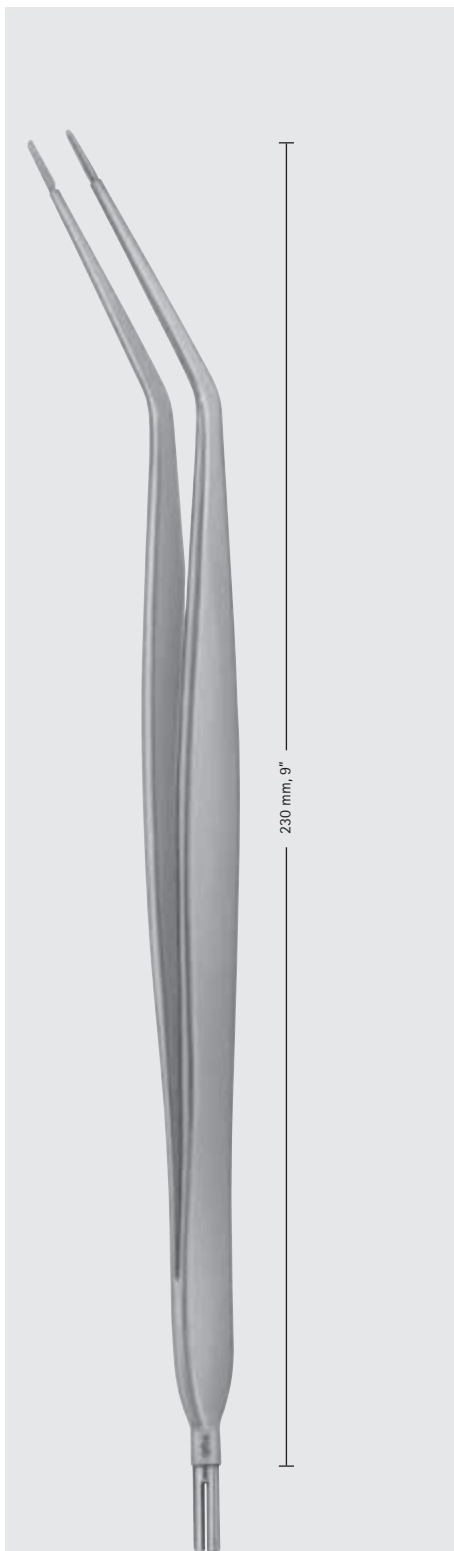

REMINGTON-HOBB
GK739R

250 mm, 10"



Elektrochirurgie – Electro Surgery
 Pinzetten, isoliert
 Forceps, Insulated

MONOPOLAR

AIRAUMATA®

GK



BD852R	BD853R	BD854R
200 mm	240 mm	300 mm
8"	9 1/2"	12"

Anatomische Pinzette
 Dissecting Forceps



BD855R	BD856R	BD857R
200 mm	240 mm	300 mm
8"	9 1/2"	12"

1 x 2 Zähne
 1 x 2 teeth



BD858R	BD859R	BD860R
200 mm	240 mm	300 mm
8"	9 1/2"	12"

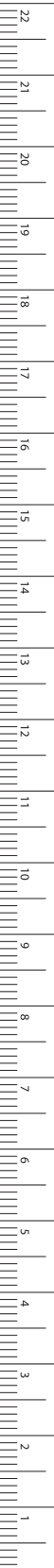

MILLIMETERS

Elektrochirurgie – Electro Surgery

Klemmen, isoliert
Forceps, Insulated

MONOPOLAR



GK

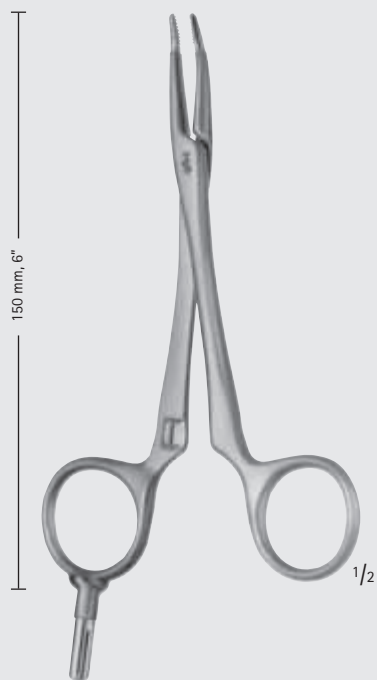

RICHES

BH353R

175 mm, 7"

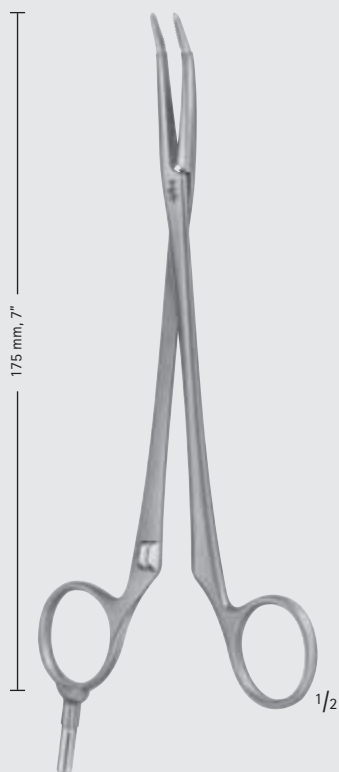

RICHES

BH354R

200 mm, 8"

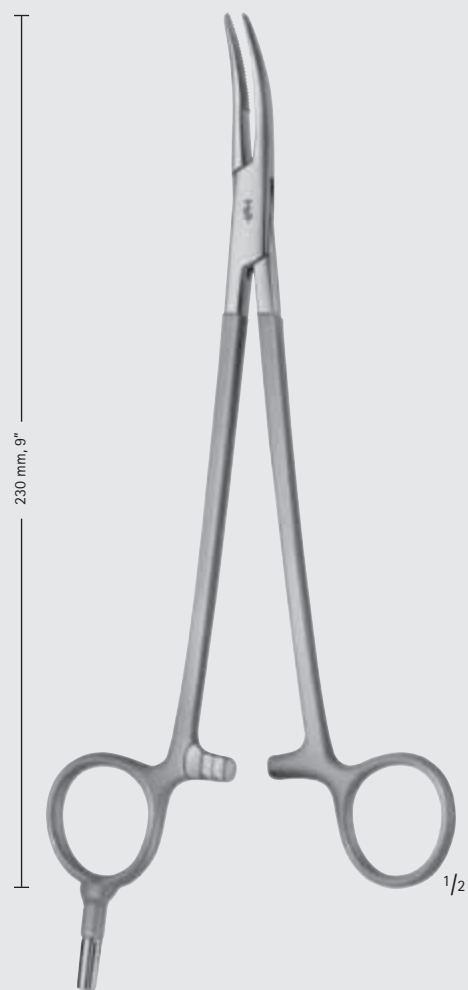

WILSON-HEY

BH243R

255 mm, 10"



Elektrochirurgie – Electro Surgery

Koagulations-Absaugkanülen
Coagulation Suction Cannula

GK

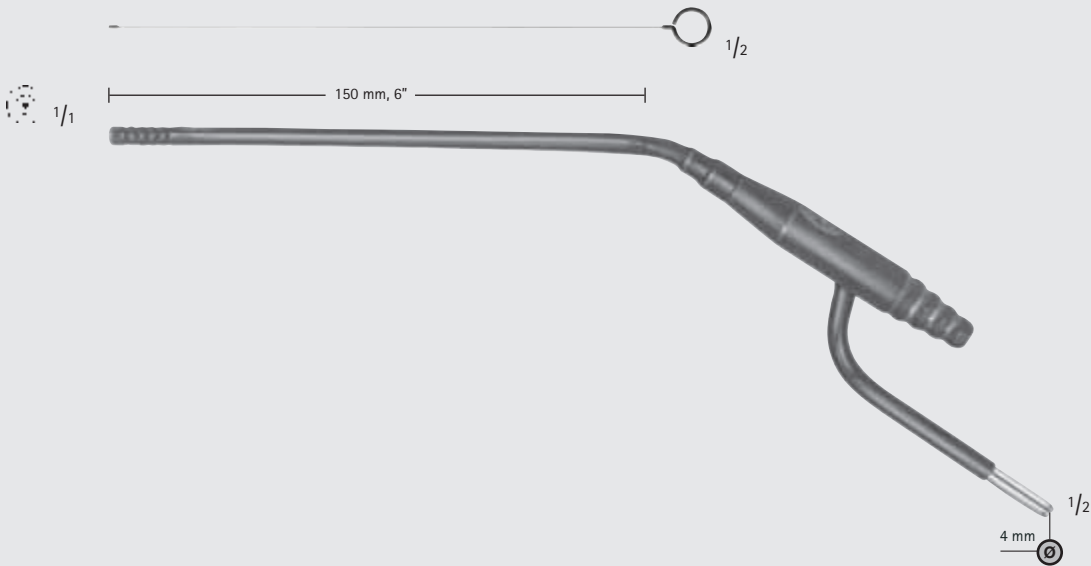

LANDOLT

GK550

Koagulations-Absaugkanüle mit Mandrin
Coagulation suction cannula with mandrel

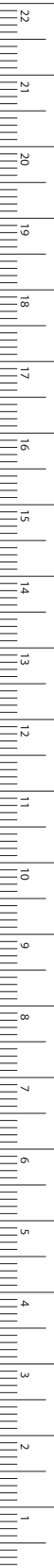

MILLIMETERS

Elektrochirurgie – Electro Surgery

Anschlusskabel
Connecting Cables

MONOPOLAR

GK



Geräteseite - Hersteller
On the equipment side - Manufacturer

Instrumentenseite
On the instrument side

GN202

3,5 m

Aesculap
ACMI
Berchtold
Martin



GN204

3,5 m



GK239

3,5 m

Erbe ACC/ICC



GN216

Aesculap

Monopolar Adapter
Monopolar adapter



Erbe, Storz

GK245

3,5 m

Erbe T



GK180

3,5 m



GK246

3,5 m

ACMI
Conmed
Erbe ICC intern.
Eschmann
Valleylab
US-Norm



GK181

3,5 m

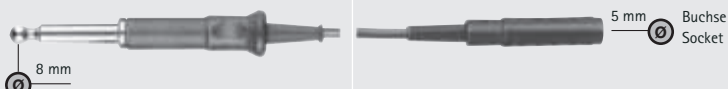

BIPOLAR



Aesculap Rundstecker
Aesculap round pin connector

schwarz isoliert
black insulation



GK690R
120 mm, 4 3/4"



GK720R-GK722R
160 mm, 6 1/4"



GK723R
160 mm, 6 1/4"

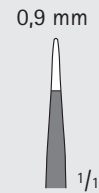

GK730R
200 mm, 8"

Drahtbürstchen zum Reinigen von Koagulationspinzetten und Koagulationselektroden.
Wire brush for cleaning coagulation forceps and coagulation electrodes.



GK299



Elektrochirurgie – Electro Surgery

Mikro- und Laborpinzetten

Micro and Laboratory Forceps

BIPOLAR



Euro Flachstecker
Euro tab connector

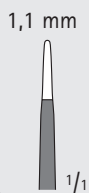

GK809R

scharf
sharp
125 mm, 5"

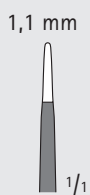

GK807R

fein
delicate
175 mm, 7"

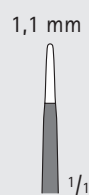

GK808R

fein
delicate
220 mm, 8 3/4"

GK





Elektrochirurgie – Electro Surgery
 Standard Koagulationspinzetten
 Standard Coagulation Forceps

BIPOLAR



Aesculap Flachstecker
 Aesculap tab connector

GK

0,6 mm 0,9 mm
 $\frac{1}{1}$ $\frac{1}{1}$

GK700R GK701R

GK700R-GK701R
 160 mm, 6 1/4"

0,9 mm
 $\frac{1}{1}$

GK703R
 200 mm, 8"

0,9 mm
 $\frac{1}{1}$

GK711R
 160 mm, 6 1/4"

0,9 mm
 $\frac{1}{1}$

GK713R
 200 mm, 8"



MILLIMETERS

Elektrochirurgie – Electro Surgery

Standard Koagulationspinzetten

Standard Coagulation Forceps

BIPOLAR

GK



Aesculap Flachstecker
Aesculap tab connector



0,6 mm

1/1

GK595R

120 mm, 4 3/4"



0,3 mm

1/1

GK596R

145 mm, 5 3/4"



0,6 mm

1/1

GK597R

110 mm, 4 3/8"



Elektrochirurgie – Electro Surgery
 Sintram Koagulationspinzetten
 Sintram Coagulation Forceps

BIPOLAR



Aesculap Flachstecker
 Aesculap tab connector



Bipolare Koagulationspinzette mit Sintram-Spitzen verhindern das Ankleben der koagulierten Gefäße.
 Bipolar coagulation forceps with Sintram tips do not stick to coagulated vessels.

GK

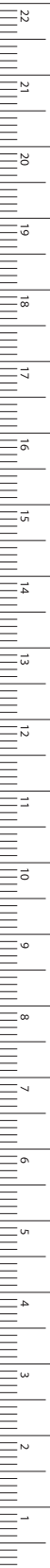

GK604R
 160 mm, 6 1/4"
 gerade
 straight

GK605R
 185 mm, 7 1/4"
 gerade
 straight

GK606R
 200 mm, 8"
 gerade
 straight

GK624R
 160 mm, 6 1/4"
 abgewinkelt
 angled

GK625R
 200 mm, 8"
 abgewinkelt
 angled

Elektrochirurgie – Electro Surgery

Pinzette, vollisolierte Spitze

Forceps, Fully Insulated Tip

BIPOLAR

GK



Aesculap Flachstecker
Aesculap tab connector



BARRE

GK685R

260 mm,
10 1/4"



GK881R

160 mm,
6 1/4"



GK882R

200 mm,
8"



GK883R

230 mm, 9"



GK884R

250 mm,
10"



GK885R

300 mm,
12"



GK886R

160 mm,
6 1/4"



Elektrochirurgie – Electro Surgery
 Pinzette, teilisolierte Spitze
 Forceps, Partly Insulated Tip

BIPOLAR



Aesculap Flachstecker
 Aesculap tab connector

GK



1/2

GK891R

160 mm,
 6 1/4"



1/2

GK892R

200 mm,
 8"



1/2

GK893R

230 mm,
 9"



1/2

GK894R

250 mm,
 10"



1/2

GK895R

300 mm,
 12"



1/2

GK896R

160 mm,
 6 1/4"

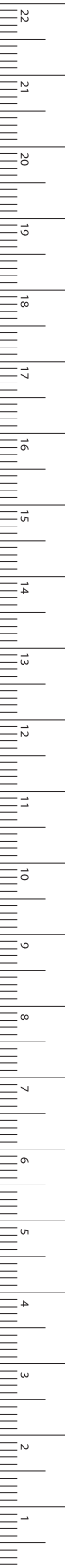

MILLIMETERS

Elektrochirurgie – Electro Surgery

Präparierscheren
Dissecting Scissors

BIPOLAR

GK

biopJet



METZENBAUM

BC685R-BC686R

180 mm, 7"



METZENBAUM

BC687R-BC688R

230 mm, 9"



METZENBAUM

BC689R-BC690R

280 mm, 11"

Länge
Length

180 mm

7"

230 mm

9"

280 mm

11"



1/1

Standard-Spitze
Standard tip

BC685R

BC687R

BC689R



1/1

Feine Spitze
Fine tip

BC686R

BC688R

BC690R



Anti Verdreh Kabel

Kabel und Anschlüsse sind so konstruiert, dass sich die Kabel nicht verdrehen können. Dadurch ist gewährleistet, dass die Schere auch nach mehrmaligem Rotieren noch geöffnet werden kann.

Anti-twist cable

The BiopJet cable and jack are designed and constructed in such a way that the cable cannot become twisted. This means that the scissors can still be opened even after being rotated repeatedly.



Elektrochirurgie – Electro Surgery

Klemmen und Handschalter

Bipolar Forceps and Finger Switches

BIPOLAR

bipoJet



BH686R	BH687R	BH689R
180 mm	230 mm	280 mm
7"	9"	11"



BH686R-BH689R

Bipolare Handschalter

- ermöglichen die Aktivierung des HF Generators ohne Fußschalter
- verwendbar mit GN640 Nelson deluxe oder der bipolaren Schaltbox GN310

Bipolar finger switches

- allows the activation of the HF generator without foot switch
- to be used with GN640 Nelson deluxe or with the bipolar switch box GN310



GN084

für BipoJet Schere
for BipoJet scissors



GN086

für BipoJet Klemmen
for BipoJet clamps

Nelson Bibox - Bipolare Schaltbox

- ermöglicht den Anschluss der Handschalter GN084 und GN086 an HF Geräte anderer Hersteller
- es können bis zu zwei bipolare Instrumente mit Hand- oder Fußschalter betrieben werden

Nelson Bibox - Bipolar switchbox

- allows the connection of the finger switches GN084 and GN086 to HF units of other suppliers
- allows the use of two bipolar instruments parallelly with finger or foot switch activation



305 x 75 x 305 mm

GN310

Nelson Bibox
Bipolare Schaltbox
Nelson Bibox
Bipolar switchbox

Weitere Informationen finden Sie in unserem Prospekt C304.
For further details see brochure No. C304.

GK

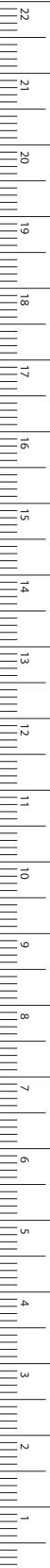

MILLIMETERS

Elektrochirurgie – Electro Surgery

Anschlusskabel
Connecting Cables

BIPOLAR

GK



Geräteseite - Hersteller
On the equipment side - Manufacturer

Instrumentenseite
On the instrument side

GN080

5 m

ACMI
Codman
Conmed
Erbe international
Olympus
Valleylab

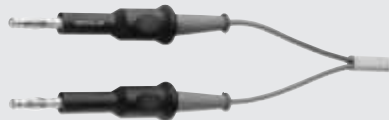

GN081

5 m

Aesculap
Berchthold
Martin
R. Wolf



GN082

5 m

Erbe
Storz



GN083

5 m

Für Aesculap
Elektrochirurgie
Geräte:
For Aesculap
Generators:
GK020
GK021
GK030
GK034
GK050
GK051



GN085

5 m

Aesculap
Bowa
EMC
Lamidey
Söring
Valleylab





Elektrochirurgie – Electro Surgery

Anschlusskabel Connecting Cables

BIPOLAR

Geräteseite - Hersteller
On the equipment side - Manufacturer

Instrumentenseite
On the instrument side

GN073

3,5 m

GN077

5,0 m

GN076

3,5 m

GN078

5,0 m

GN074

3,5 m

Aesculap
ACMI
Berchtold
Martin
Wolf

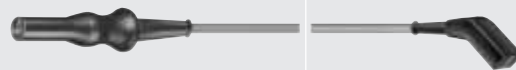

 Aesculap
Flachstecker
tab connector

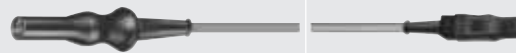

 Euro-Flachstecker
Euro tab connector

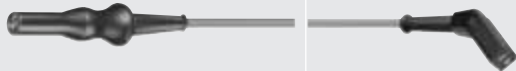

 Aesculap
Rundstiftstecker
Round pin connector

GK200

3,5 m

GK183

3,5 m

GK210

3,5 m

Aesculap
ACMI
Codman
Conmed
Olympus
Valleylab



 Aesculap
Flachstecker
tab connector



 Euro-Flachstecker
Euro tab connector



 Aesculap
Rundstiftstecker
Round pin connector

XF830

3,5 m

GK216

3,5 m

GK213

5 m

GK185

3,5 m

GK188

5,0 m

Erbe
Storz

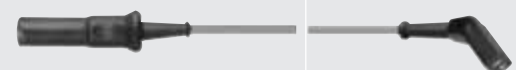

 Aesculap
Rundstiftstecker
Round pin connector

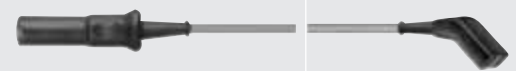

 Aesculap
Flachstecker
tab connector

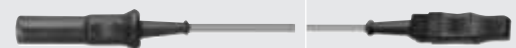

 Euro-Flachstecker
Euro tab connector

GN217

Aesculap

Bipolar Adapter
Bipolar adapter



Erbe, Storz

GK

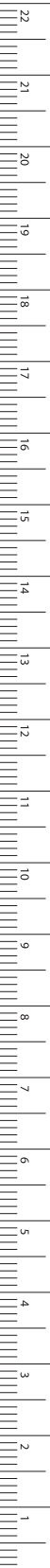

MILLIMETERS

Elektrochirurgie – Electro Surgery

Anschlusskabel Connecting Cables

BIPOLAR

GK



Geräteseite - Hersteller

On the equipment side - Manufacturer

Instrumentenseite

On the instrument side

GK217

3,5 m

Codman



▬ Aesculap
Flachstecker
tab connector

GK193

3,5 m

Aesculap
Bowa
EMC
Lamidey
Söring
Valleylab



▬ Aesculap
Flachstecker
tab connector

GK194

3,5 m



▬ Euro-Flachstecker
Euro tab connector

GK202

3,5 m

AESCULAP
GK020
GK021
GK030
GK034
GK050
GK051

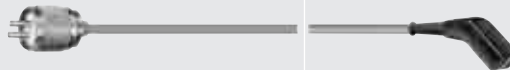

▬ Aesculap
Flachstecker
tab connector

GK212

3,5 m

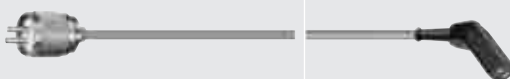

●● Aesculap
Rundstiftstecker
Round pin connector

Single Use

GK211

3,5 m

PAK =
Packung à
10 Stück
PAK =
Package of
10 pieces

AESCULAP
ACMI
Codman
Conmed
Olympus
Valleylab

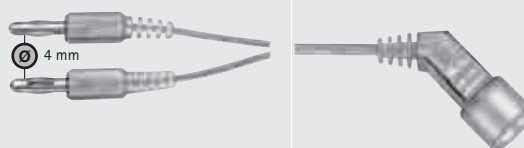

▬ für Pinzetten mit
Aesculap-Flach-
stecker und
●● Rundstiftstecker
for forceps with
Aesculap tab con-
nector and round
pin connector



Elektrochirurgie – Electro Surgery Zubehör Accessoir

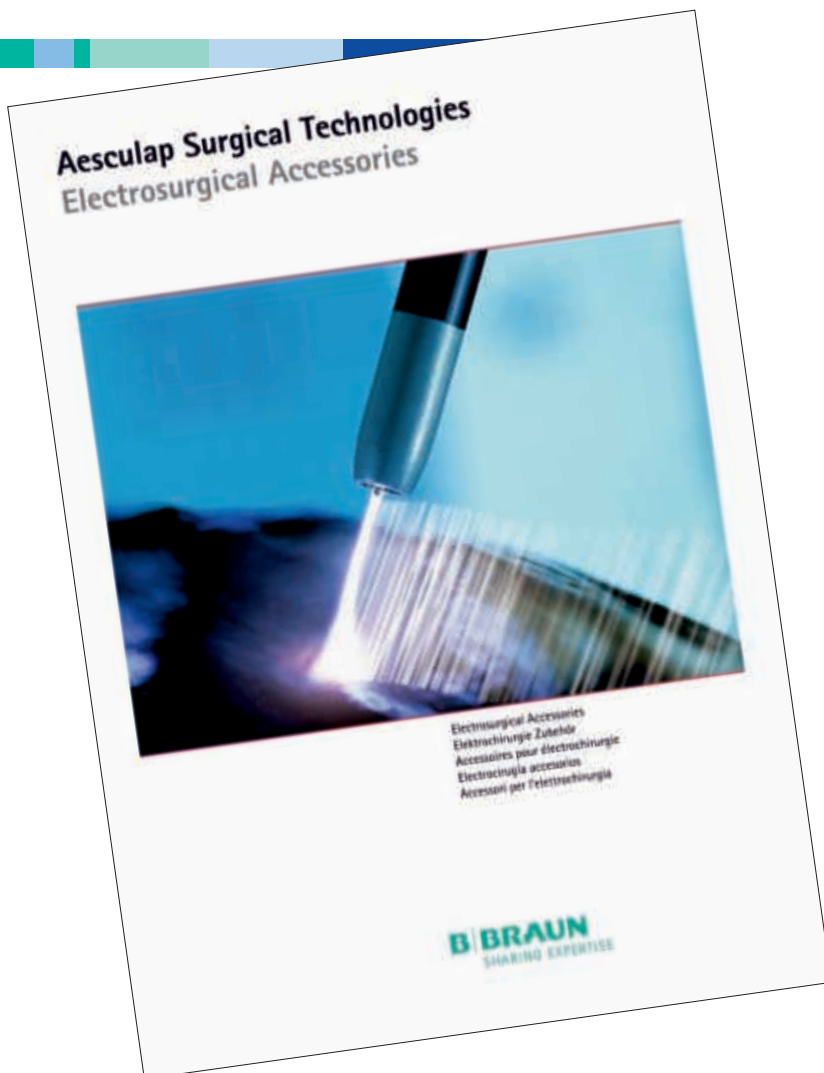

Weitere Informationen finden Sie in unserem Prospekt **C30481**.

For further details see brochure No. **C30481**.

Inhalt C30481 „Elektrochirurgie Zubehör“ Table of Contents C30481 "Electrosurgical Accessories"

- ⌘ Geräte und Zubehör
Units and Accessories
- ⌘ Monopolares Equipment für die offene Chirurgie
Monopolar equipment for open surgery
- ⌘ Bipolares Equipment – Koagulationspinzetten
Bipolar equipment – Coagulation forceps
- ⌘ Neutralelektroden
Neutral electrodes
- ⌘ Kabel und Adapter
Cables and Adapter
- ⌘ Elektrochirurgie in der Endoskopie
Electrosurgical Endoscopy

GK



MILLIMETERS

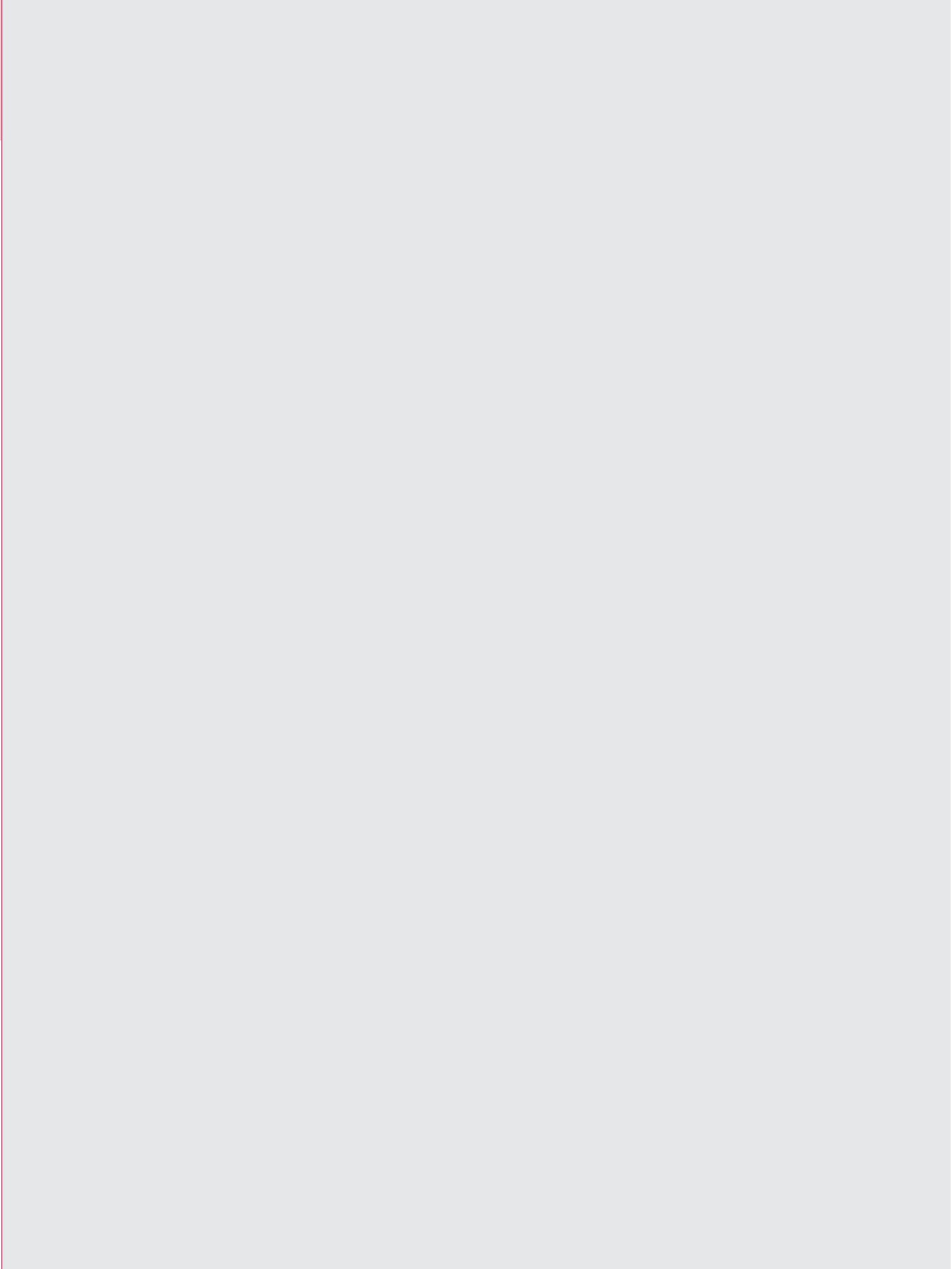

EA



**Abdominale Chirurgie, Magen-, Darm-
und Rektum-Instrumente**

Abdominal Surgery, Intestinal- and
Rectal Instruments

Abdominale Chirurgie – Abdominal Surgery

Darm- und Gewebefasszangen

Intestinal- and Tissue Grasping Forceps

EA



CHAPUT

BF300R

125 mm, 5"



TUFFIER

BF301R

125 mm, 5"

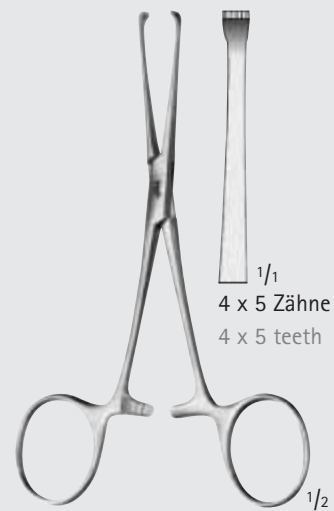

BABY-ALLIS

EA012R

130 mm, 5 1/8"

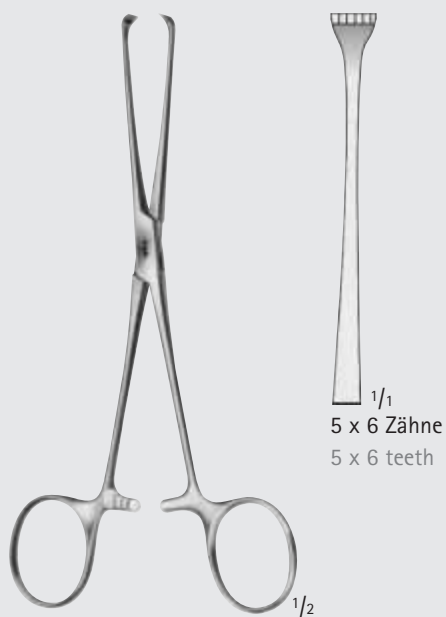

BOYS-ALLIS

EA010R

155 mm, 6"

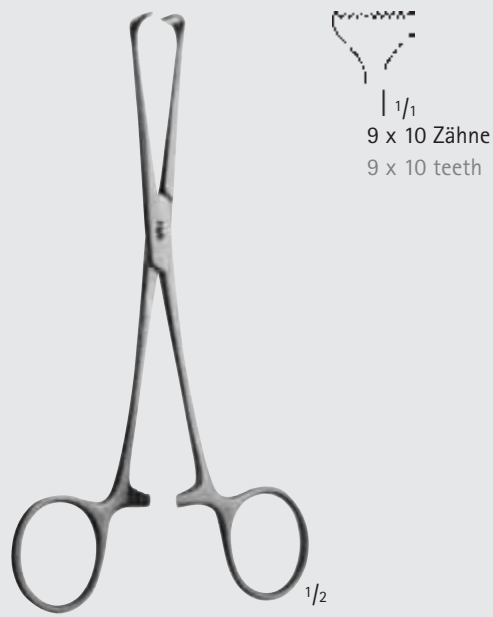

ALLIS-ADAIR

MD568

160 mm, 6 1/4"





Abdominale Chirurgie – Abdominal Surgery

Darm- und Gewebefasszangen Intestinal- and Tissue Grasping Forceps

EA



EA013R	EA014R	EA015R
2 x 3 Zähne 2 x 3 teeth	3 x 4 Zähne 3 x 4 teeth	4 x 5 Zähne 4 x 5 teeth

ALLIS
EA013R-EA015R
155 mm, 6"

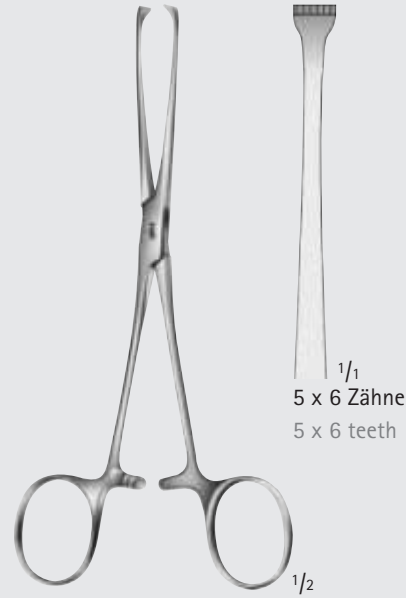

EA016R
5 x 6 Zähne
5 x 6 teeth

ALLIS
EA016R
155 mm, 6"



EA017R	EA018R
190 mm 7 1/2"	255 mm 10"

ALLIS
EA017R-EA018R
5 x 6 Zähne
zarte Modelle
5 x 6 teeth
slendern patterns



ALLIS
FB938R
220 mm, 8 3/4"



MILLIMETERS

Abdominale Chirurgie – Abdominal Surgery

Organ- und Gewebefassungen

Organ- and Tissue Grasping Forceps

EA

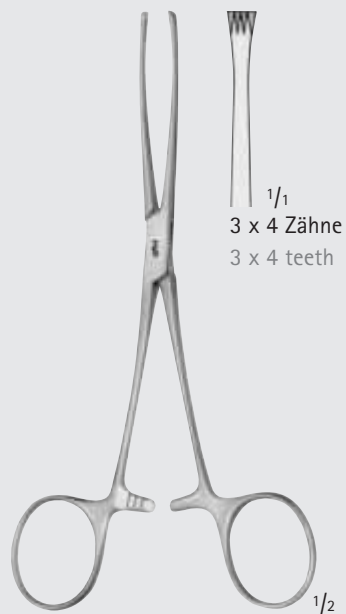

1/1
3 x 4 Zähne
3 x 4 teeth

JUDD-ALLIS

EA025R

155 mm, 6"



1/1
3 x 4 Zähne
3 x 4 teeth

JUDD-ALLIS

EA026R

195 mm, 7 3/4"

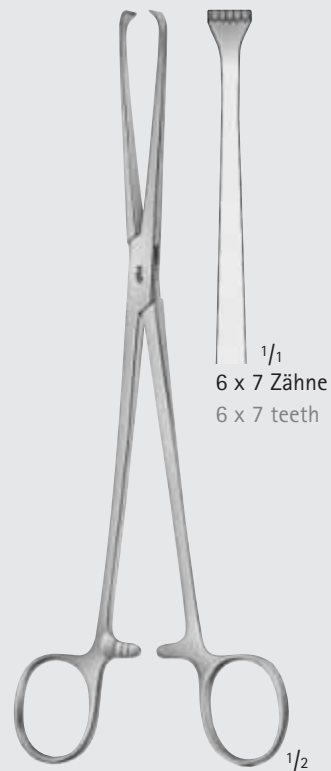

1/1
6 x 7 Zähne
6 x 7 teeth

ALLIS-THOMS

EA020R

200 mm, 8"

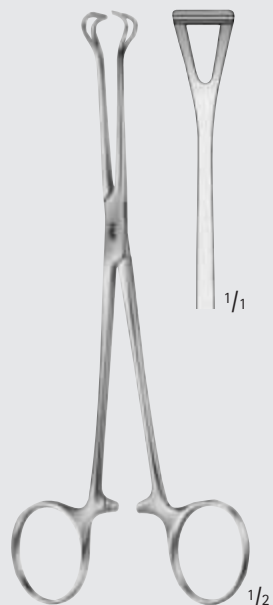

1/1

BABCOCK

EA030R

155 mm, 6"



1/1

EA031R	EA032R	EA033R
170 mm	215 mm	200 mm
6 3/4"	8 1/2"	8"

BABCOCK

EA031R-EA033R



1/1

BABCOCK

FB934R

220 mm, 8 3/4"



Abdominale Chirurgie – Abdominal Surgery
 Darmfazzangen
 Intestinal Grasping Forceps

EA

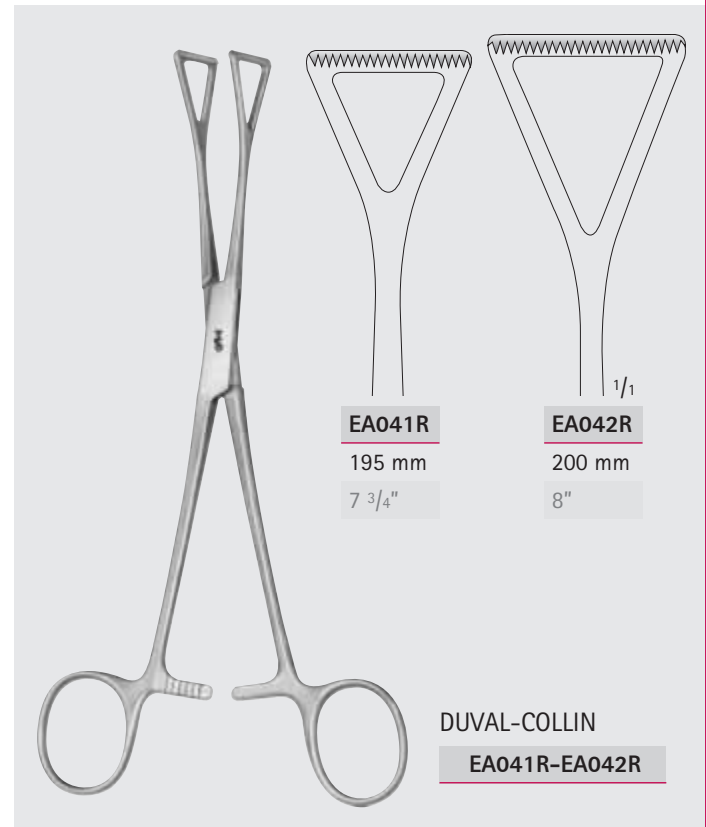
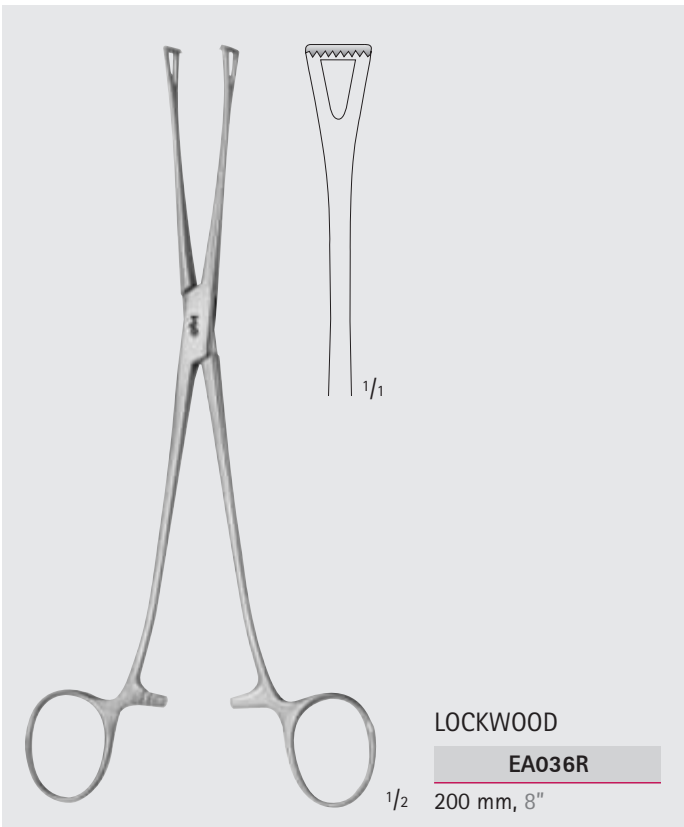
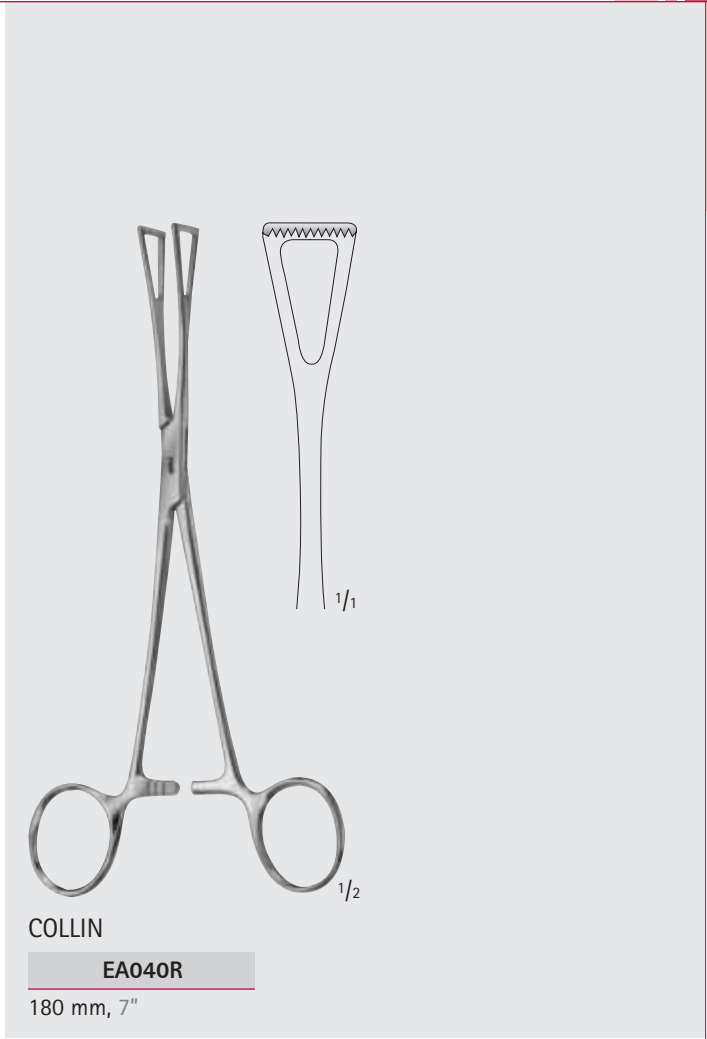
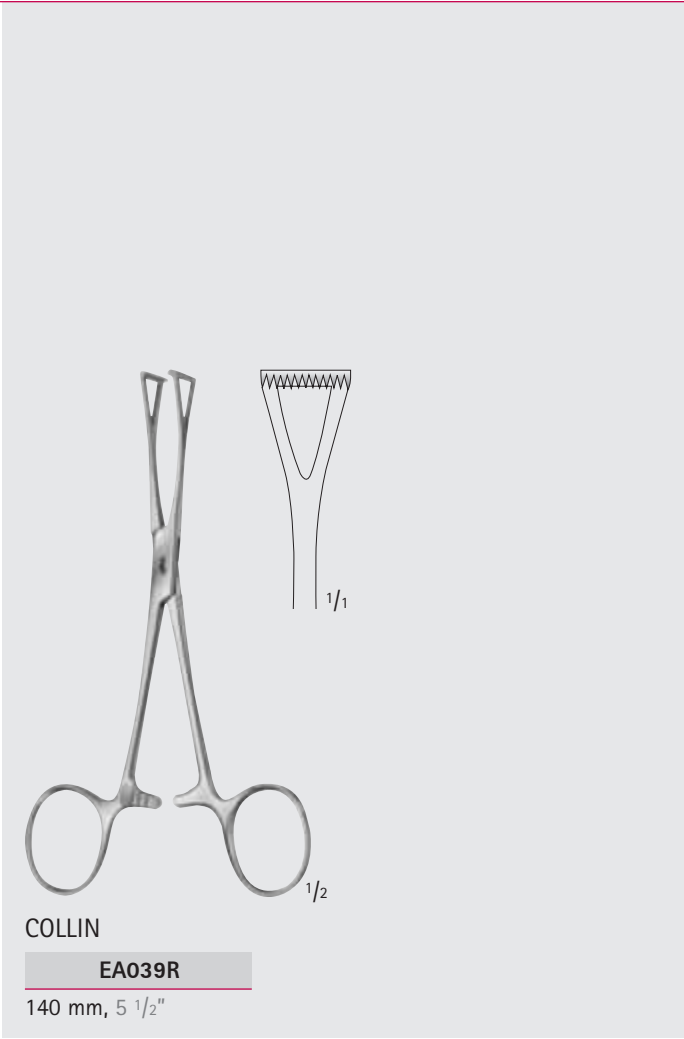
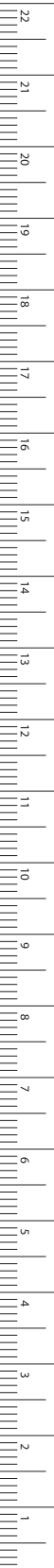

Abdominale Chirurgie – Abdominal Surgery

Darmfazzangen

Intestinal Grasping Forceps

EA

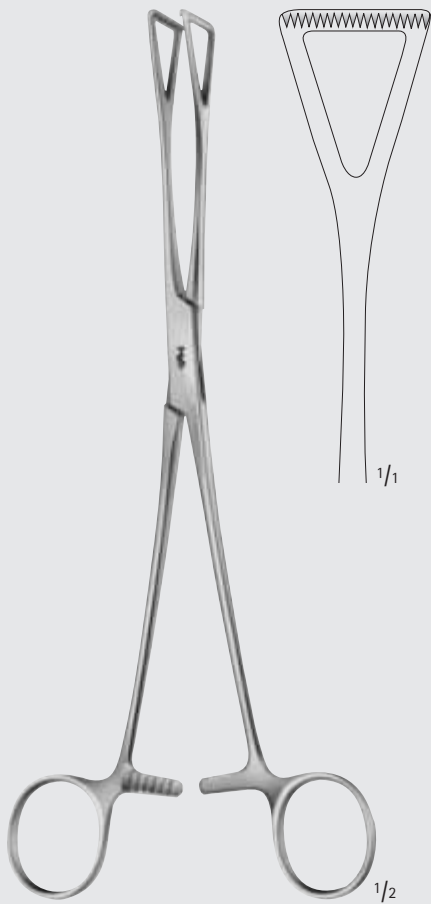
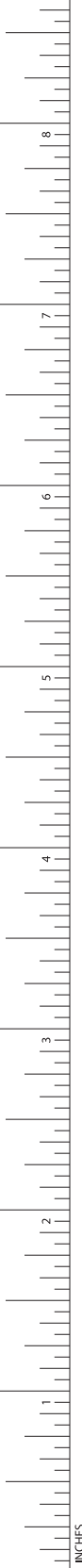

DUVAL

FB930R

230 mm, 9"

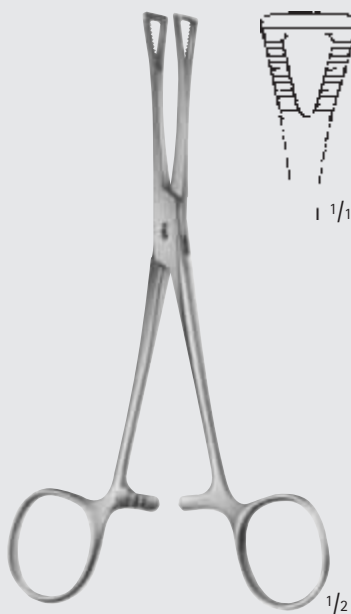

PENNINGTON

BH902R

155 mm, 6"



PENNINGTON

EA037R

200 mm, 8"



Abdominale Chirurgie – Abdominal Surgery

Organ-, Gewebefasszangen und Pinzetten

Organ-, Tissue Grasping Forceps and Dissecting Forceps

EA

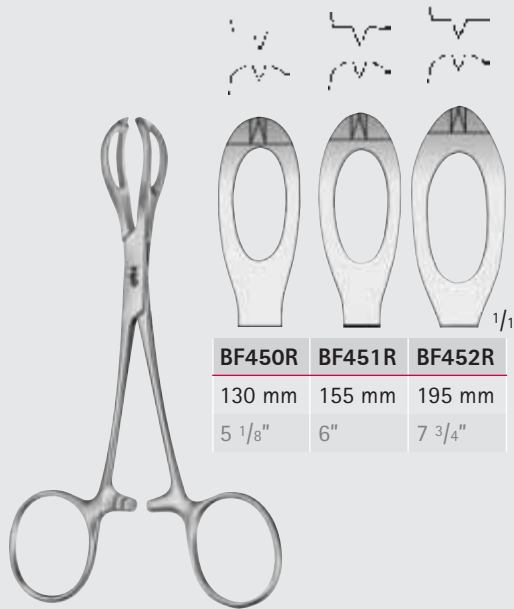
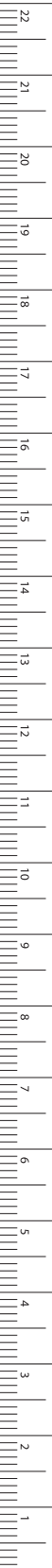

BF450R	BF451R	BF452R
130 mm	155 mm	195 mm
5 1/8"	6"	7 3/4"

LANE

BF450R-BF452R



WILLIAMS

EA028R

160 mm, 6 1/4"



DENIS-BROWNE

EA027R

190 mm, 7 1/2"



DUVAL

BD820R

140 mm, 5 1/2"



WANGENSTEIN

BD171R-BD173R

BD171R	BD173R
150 mm	230 mm
6"	9"



STILLE-BARRAYA

BD725R-BD727R

BD725R	BD726R	BD727R
180 mm	200 mm	250 mm
7"	8"	10"
3 x 4 Zähne 3 x 4 teeth	3 x 4 Zähne 3 x 4 teeth	4 x 5 Zähne 4 x 5 teeth

MILLIMETERS

Abdominale Chirurgie – Abdominal Surgery

Organ-, Gewebe- und Darmfasszangen

Organ-, Tissue and Intestinal Grasping Forceps

TRAUMATA®

EA

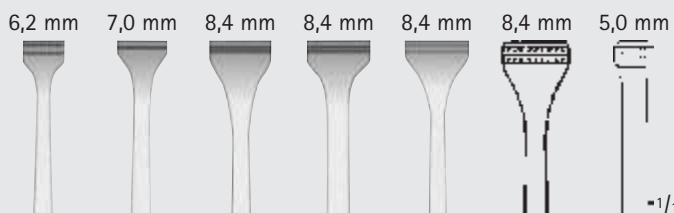

EA092R	EA095R	EA096R	EA097R	EA099R	EA101R	EA100R
155 mm	200 mm	220 mm	255 mm	300 mm	350 mm	295 mm
6"	8"	8 3/4"	10"	12"	14"	11 3/4"

ALLIS

EA092R-EA101R

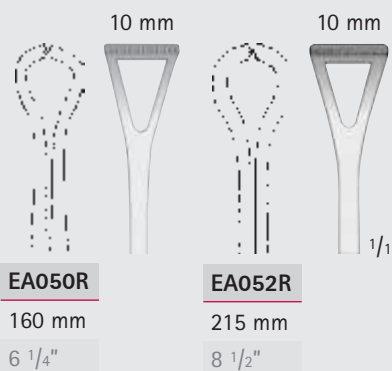

EA050R
160 mm
6 1/4"

EA052R
215 mm
8 1/2"

BABCOCK

EA050R-EA052R

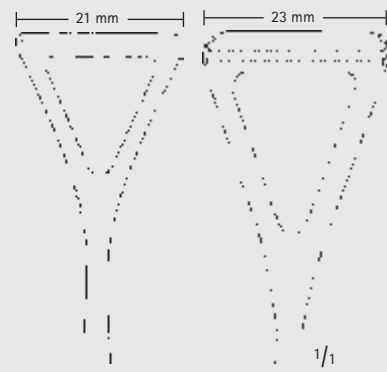

EA061R
195 mm
7 3/4"

EA062R
230 mm
9"

COLLIN

EA061R-EA062R



AIRAUMATA®

Abdominale Chirurgie – Abdominal Surgery
Organ-, Gewebe- und Darmfazzangen
Organ-, Tissue and Intestinal Grasping Forceps

EA



BABCOCK

FB936R

220 mm, 8 3/4"



BABCOCK

MD470

240 mm, 9 1/2"

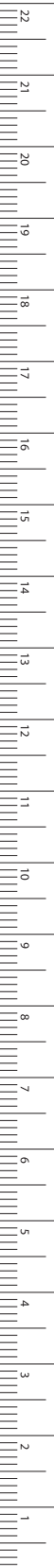

MILLIMETERS

Abdominale Chirurgie – Abdominal Surgery

Ultra-Light Pinzetten, Pinzetten

Ultra-Light-Forceps, Dissecting Forceps

ARAUMATA®

EA

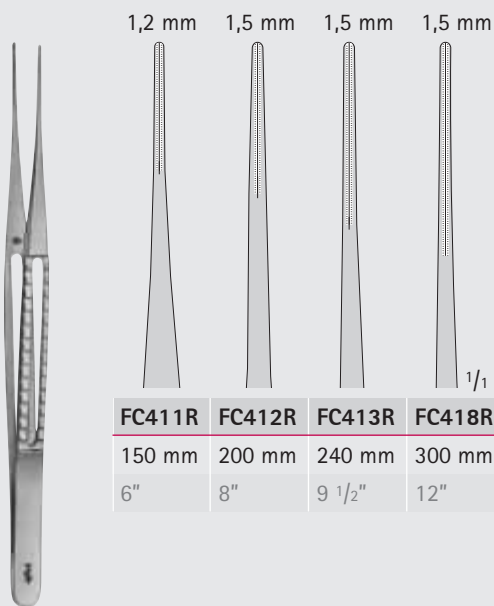
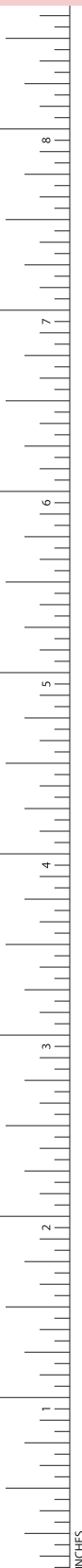

1,2 mm 1,5 mm 1,5 mm 1,5 mm

FC411R	FC412R	FC413R	FC418R
150 mm	200 mm	240 mm	300 mm
6"	8"	9 1/2"	12"

FC411R-FC418R

Ultra-Light Pinzetten
Ultra-Light-Forceps

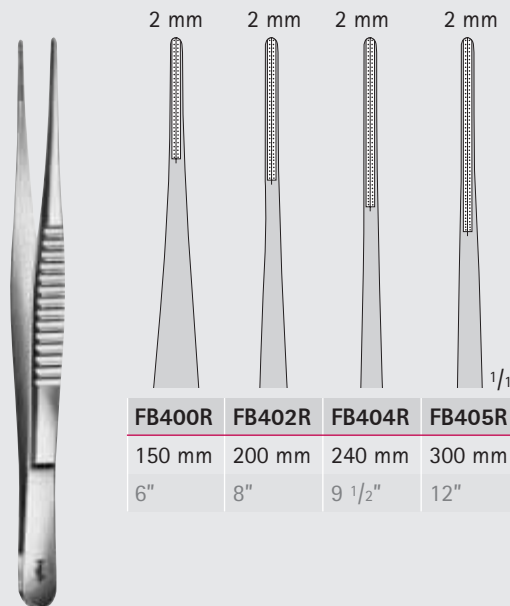

2 mm 2 mm 2 mm 2 mm

FB400R	FB402R	FB404R	FB405R
150 mm	200 mm	240 mm	300 mm
6"	8"	9 1/2"	12"

DE BAKEY

FB400R-FB405R

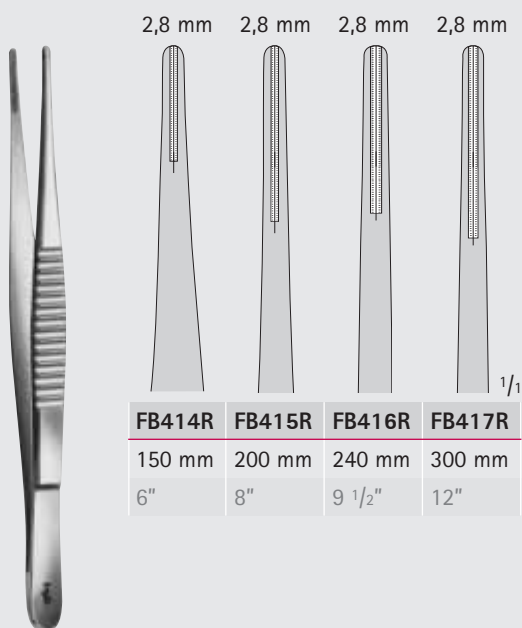

2,8 mm 2,8 mm 2,8 mm 2,8 mm

FB414R	FB415R	FB416R	FB417R
150 mm	200 mm	240 mm	300 mm
6"	8"	9 1/2"	12"

DE BAKEY

FB414R-FB417R

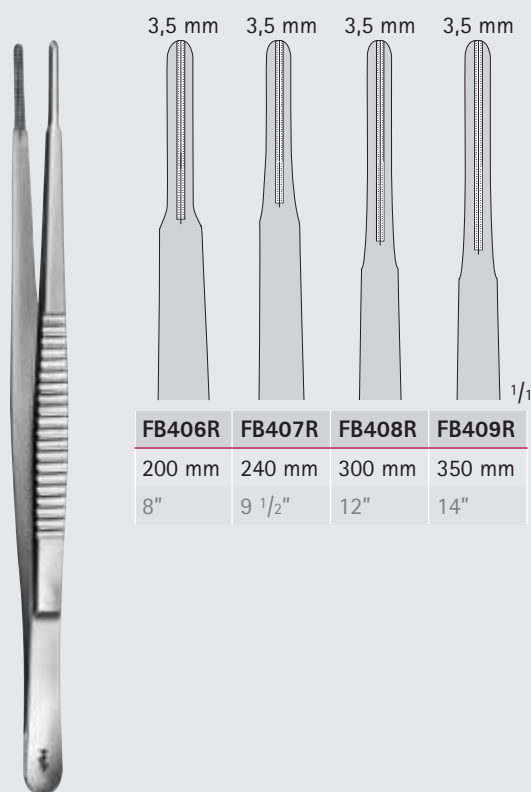

3,5 mm 3,5 mm 3,5 mm 3,5 mm

FB406R	FB407R	FB408R	FB409R
200 mm	240 mm	300 mm	350 mm
8"	9 1/2"	12"	14"

DE BAKEY

FB406R-FB409R

350 mm, 14"



Abdominale Chirurgie – Abdominal Surgery
 Darmklemmen für Kinder
 Intestinal Clamps for Children

EA

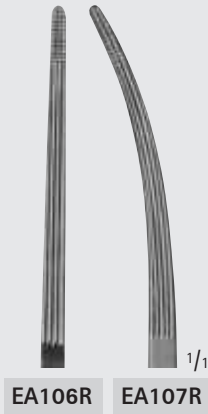
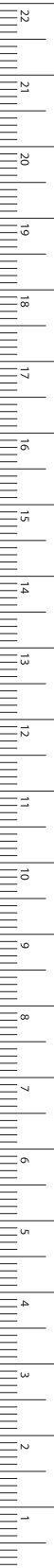

BAINBRIDGE
EA106R-EA107R
 155 mm, 6"



ALLEN
EA114R
 155 mm, 6"

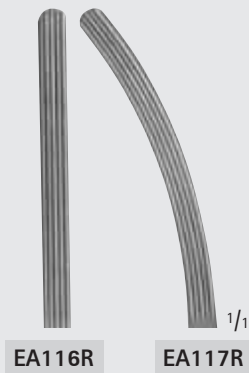

BABY-KOCHER
EA116R-EA117R
 sehr elastisch
 very elastic
 130 mm, 5 1/8"

AIRAUMATA®

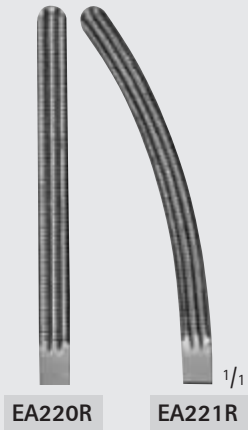

BABY-KOCHER
EA220R-EA221R
 weich und elastisch
 soft and elastic
 130 mm, 5 1/8"

Abdominale Chirurgie – Abdominal Surgery

Darmklemmen, weich federnd

Intestinal Clamps, Soft Elastic

EA

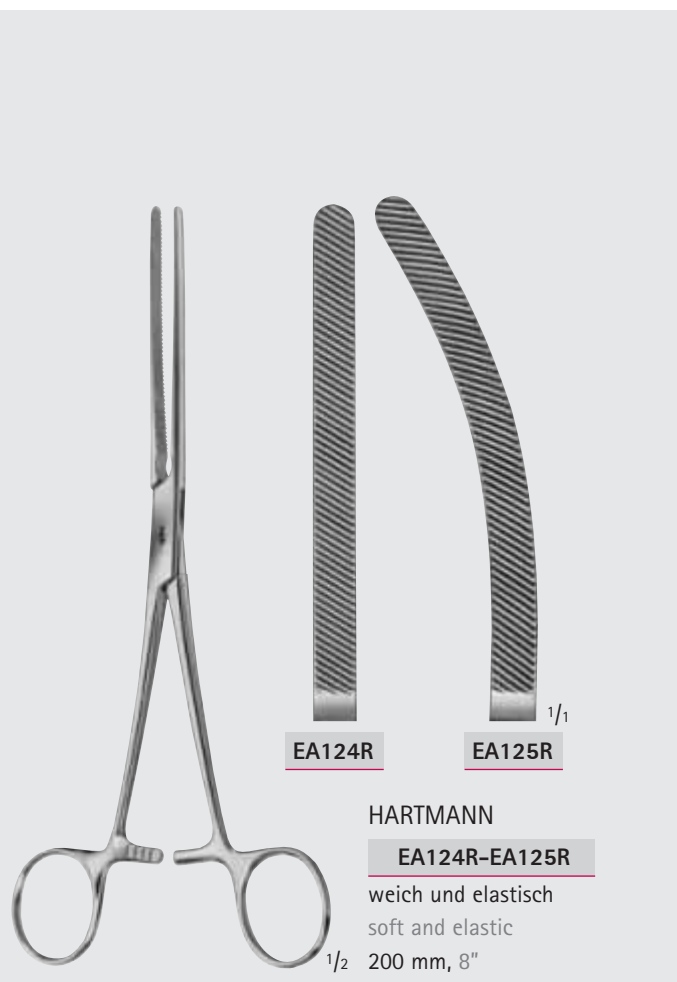
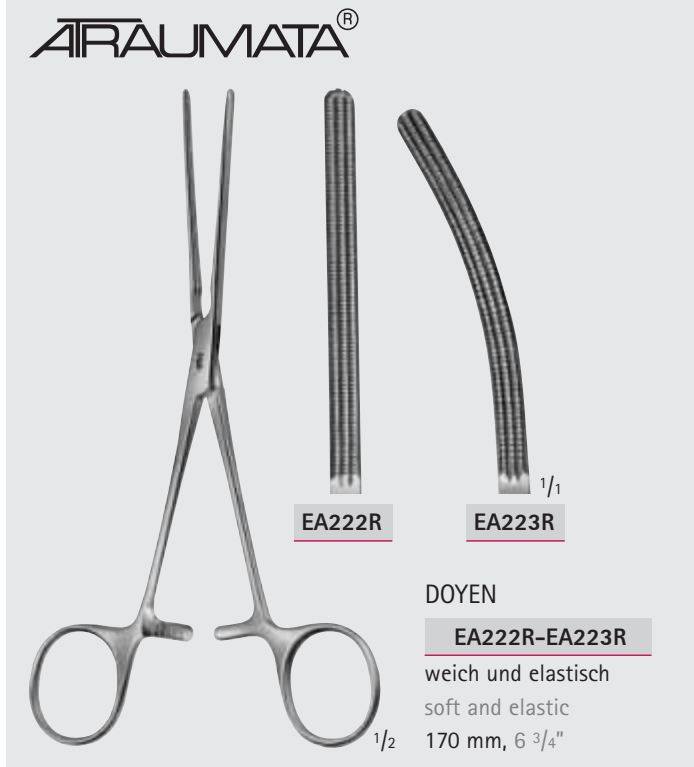



Abdominale Chirurgie – Abdominal Surgery

Darmklemmen, weich federnd
Intestinal Clamps, Soft Elastic

EA

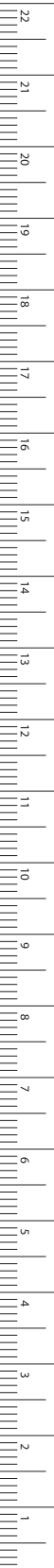

MILLIMETERS

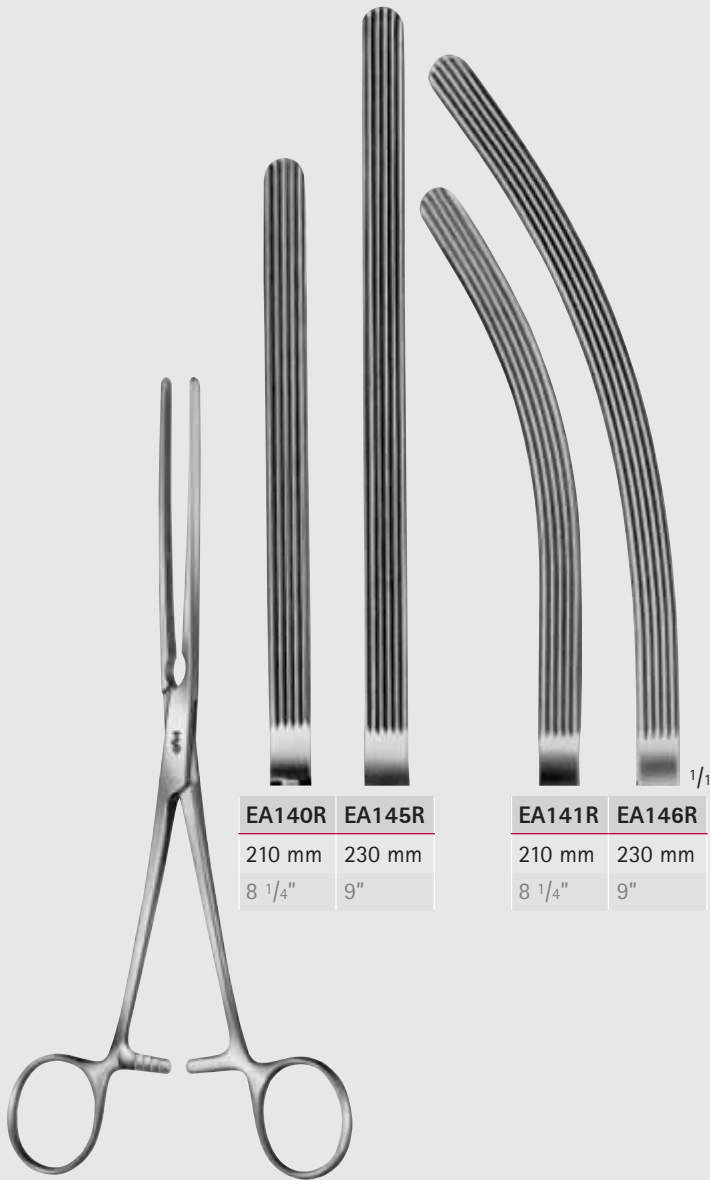

EA140R	EA145R
210 mm	230 mm
8 1/4"	9"

EA141R	EA146R
210 mm	230 mm
8 1/4"	9"

KOCHER

EA140R-EA146R

weich und elastisch
soft and elastic

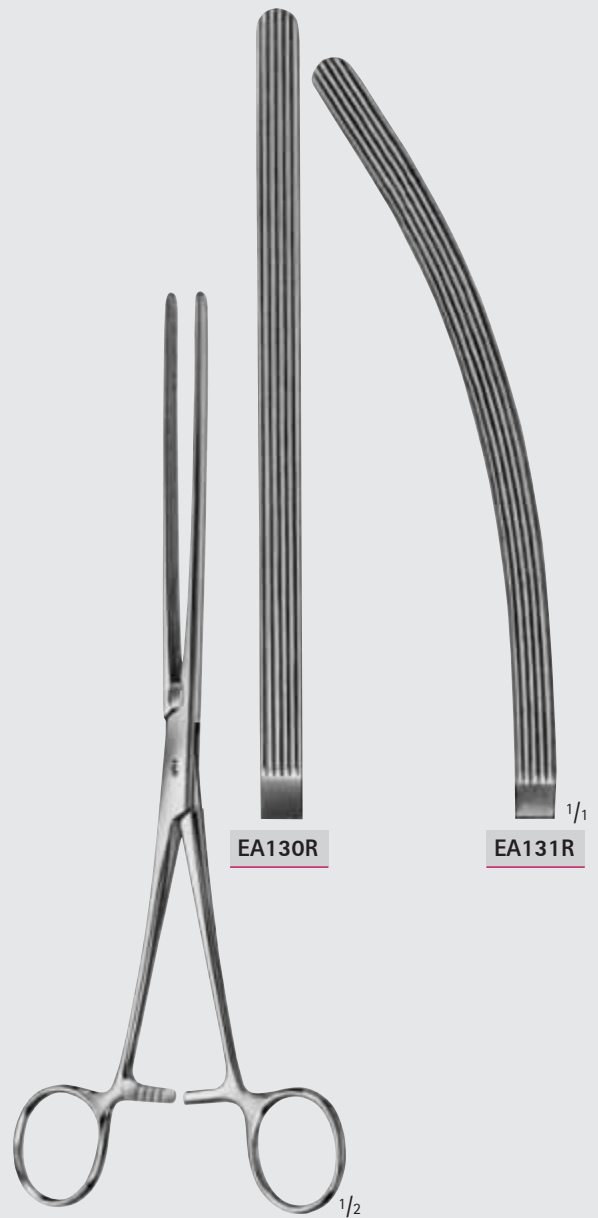

EA130R

EA131R

DOYEN

EA130R-EA131R

weich und elastisch
soft and elastic
240 mm, 9 1/2"

Abdominale Chirurgie – Abdominal Surgery

Darmklemmen, weich federnd

Intestinal Clamps, Soft Elastic

EA



DOYEN

EA126R-EA127R

weich und elastisch

soft and elastic

235 mm, 9 1/4"

AIRAUMATA®

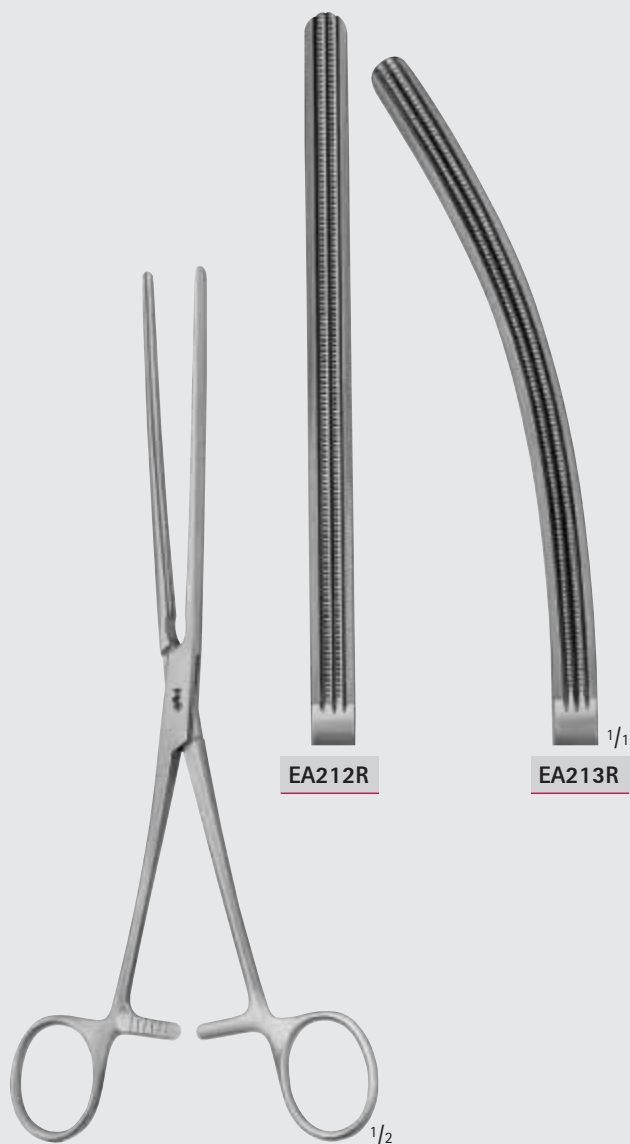

DOYEN

EA212R-EA213R

weich und elastisch

soft and elastic

230 mm, 9"



Abdominale Chirurgie – Abdominal Surgery

Darmklemmen, weich federnd
Intestinal Clamps, Soft Elastic

EA

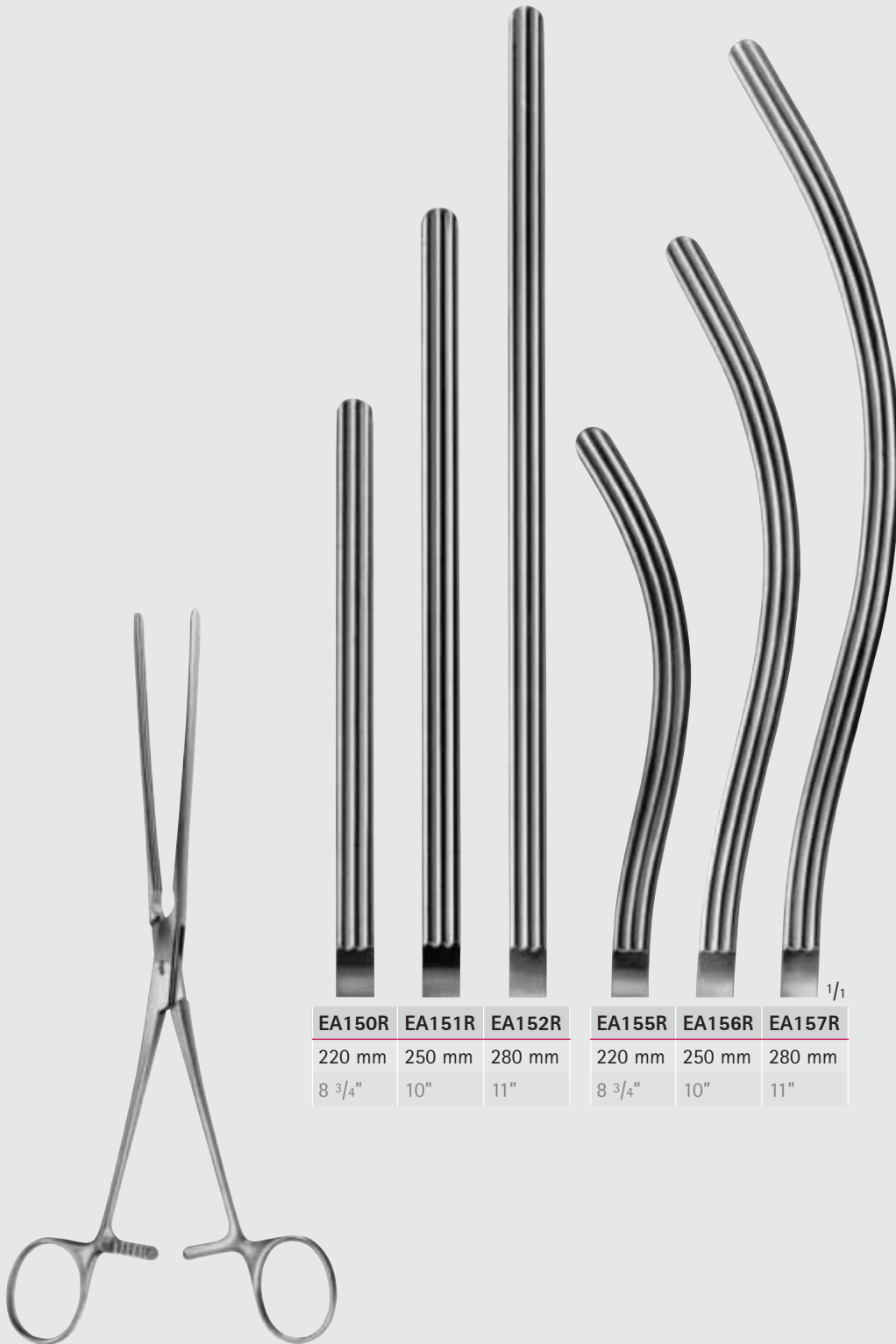

EA150R	EA151R	EA152R	EA155R	EA156R	EA157R
220 mm	250 mm	280 mm	220 mm	250 mm	280 mm
8 3/4"	10"	11"	8 3/4"	10"	11"

1/1

KOCHER

EA150R-EA157R

sehr weich und elastisch
very soft and elastic



MILLIMETERS

Abdominale Chirurgie – Abdominal Surgery

Darmklemmen, weich federnd

Intestinal Clamps, Soft Elastic

EA

TRAUMATA®



KOCHER

EA202R-EA207R

sehr weich und elastisch

very soft and elastic

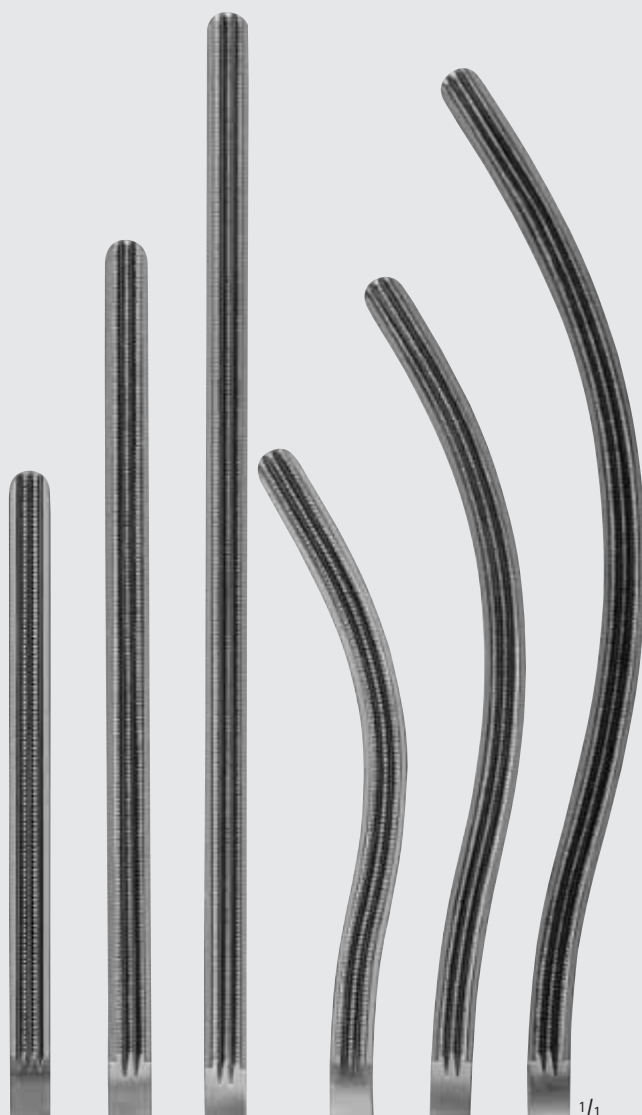

EA202R	EA204R	EA206R	EA203R	EA205R	EA207R
220 mm	250 mm	280 mm	220 mm	250 mm	280 mm
8 3/4"	10"	11"	8 3/4"	10"	11"

1/1



Abdominale Chirurgie – Abdominal Surgery

Darmklemmen
Intestinal Clamps

EA

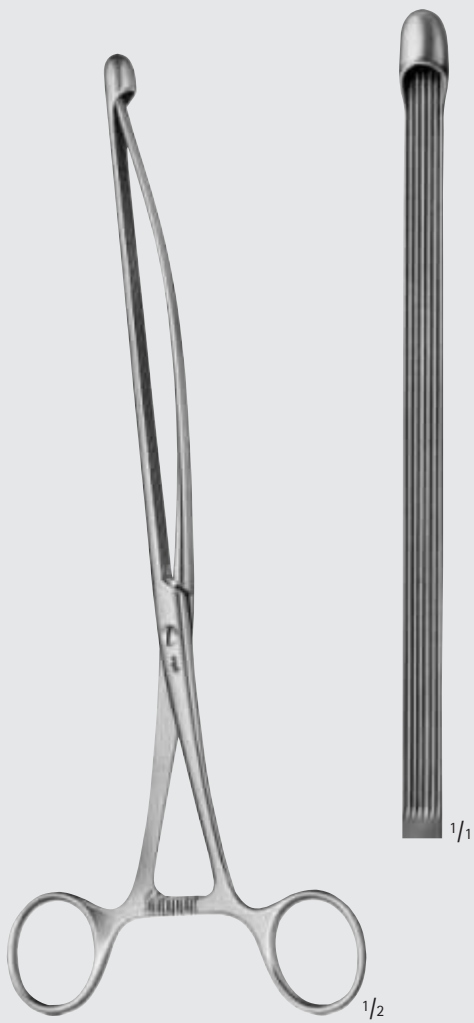

NUSSBAUM

EA176R

weich und elastisch
soft and elastic
250 mm, 10"

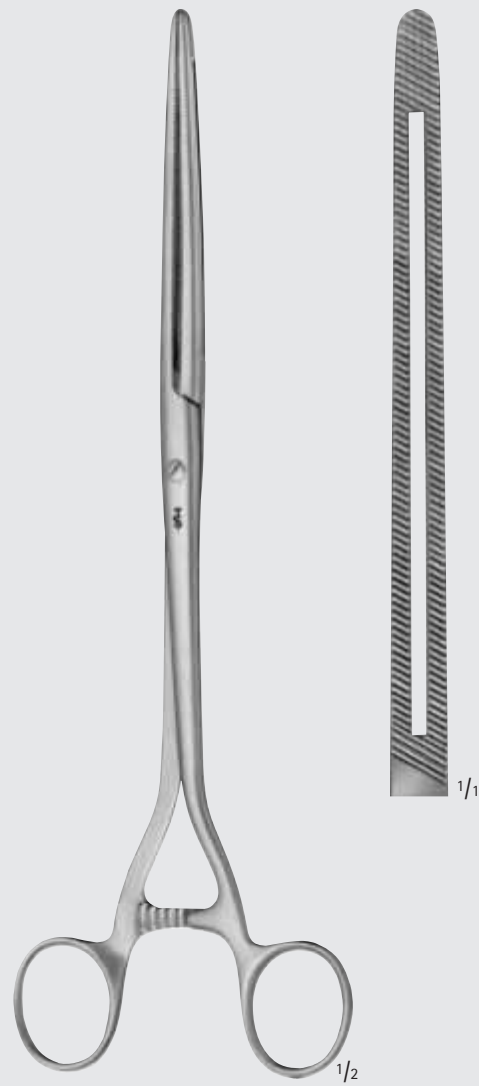

MOYNIHAN

EA182R

280 mm, 11"



MILLIMETERS

Abdominale Chirurgie – Abdominal Surgery

Darmklemmen

Intestinal Clamps

EA

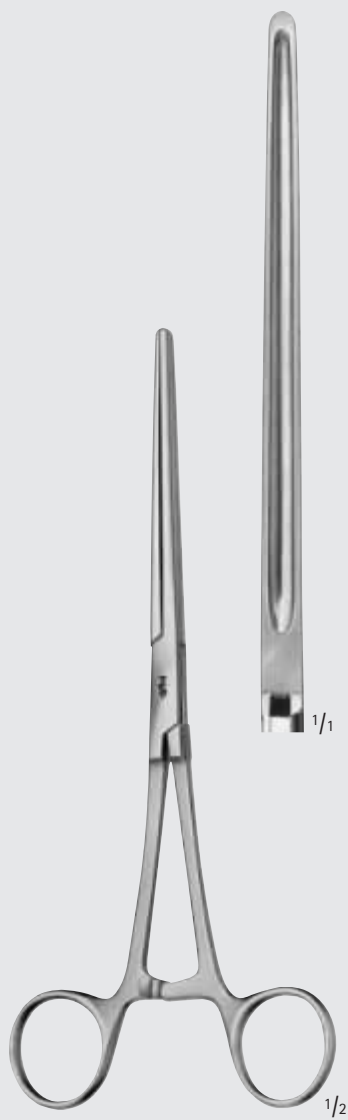

LANG-STEVENSON

EA132R

200 mm, 8"

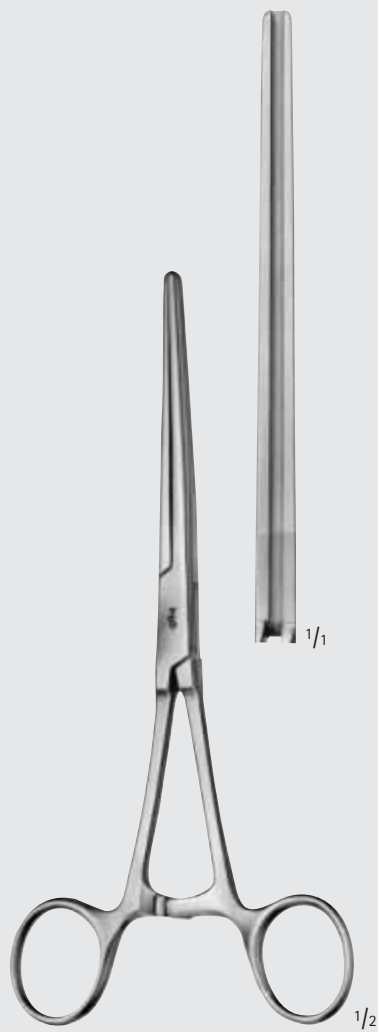

SCHOEMAKER

EA321R

Colectomie-Klemme

Colectomy clamp

200 mm, 8"



Abdominale Chirurgie – Abdominal Surgery

Darmklemmen
Intestinal Clamps

EA

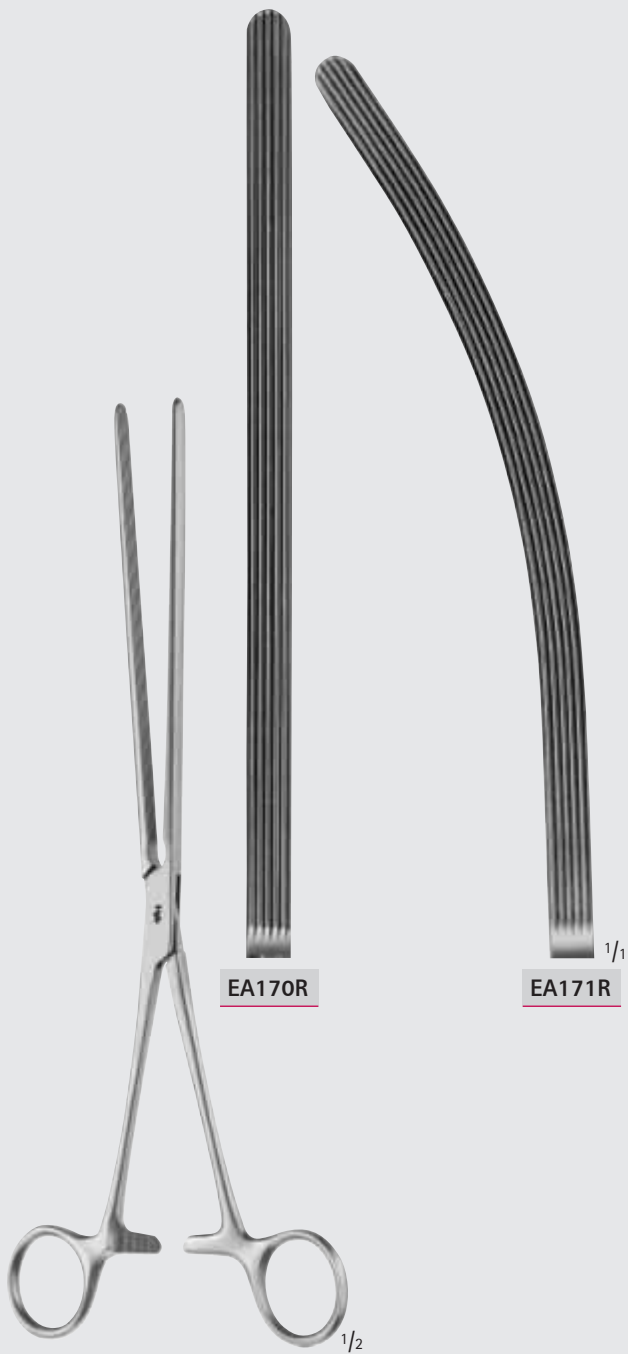

EA170R

EA171R ^{1/1}

MAYO-ROBSON

EA170R-EA171R

hart federnd
hard elastic
250 mm, 10"

AIRAUMATA[®]

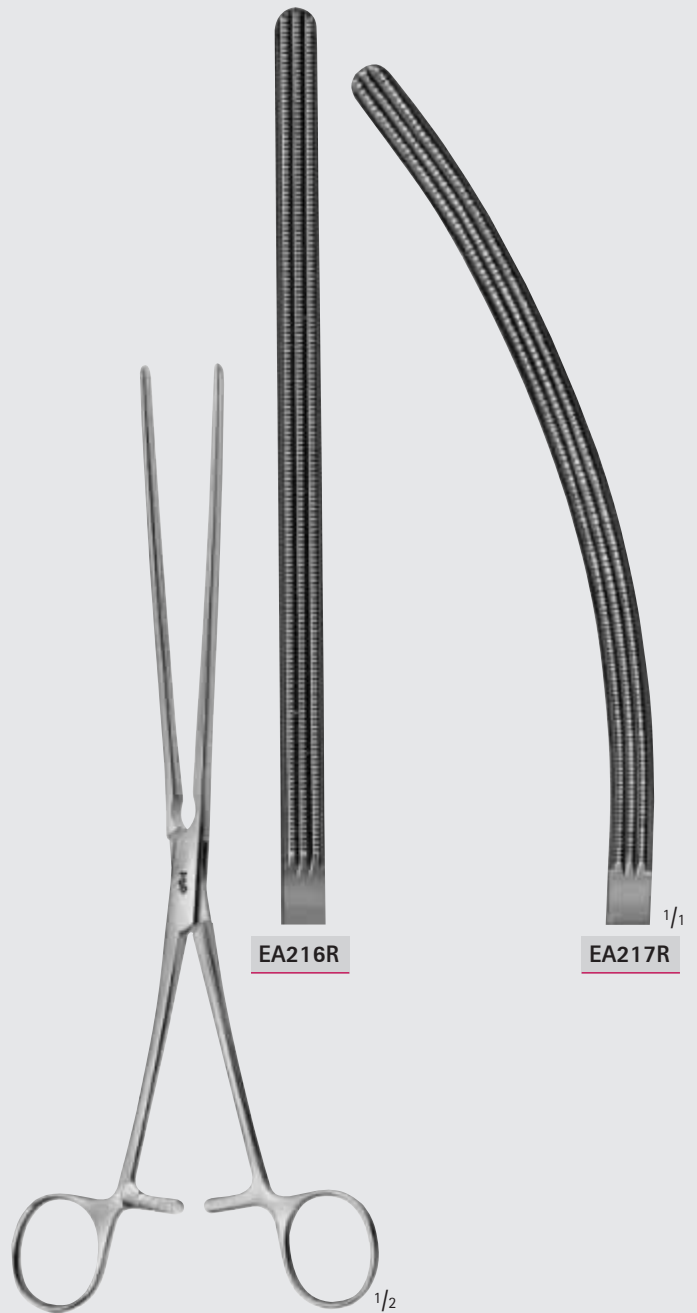

EA216R

EA217R ^{1/1}

MAYO-ROBSON

EA216R-EA217R

250 mm, 10"

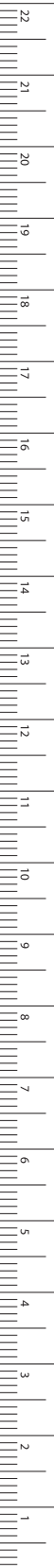

MILLIMETERS

Abdominale Chirurgie – Abdominal Surgery

Magen- und Darm- Zwillingsklemmen

Gastro- Intestinal Forceps, Twin

EA



LANE

EA440R

310 mm, 12"



LANE

EA441R

310 mm, 12"



Abdominale Chirurgie – Abdominal Surgery

Magenklemmen
Stomach Clamps

EA

AIRAUMATA®

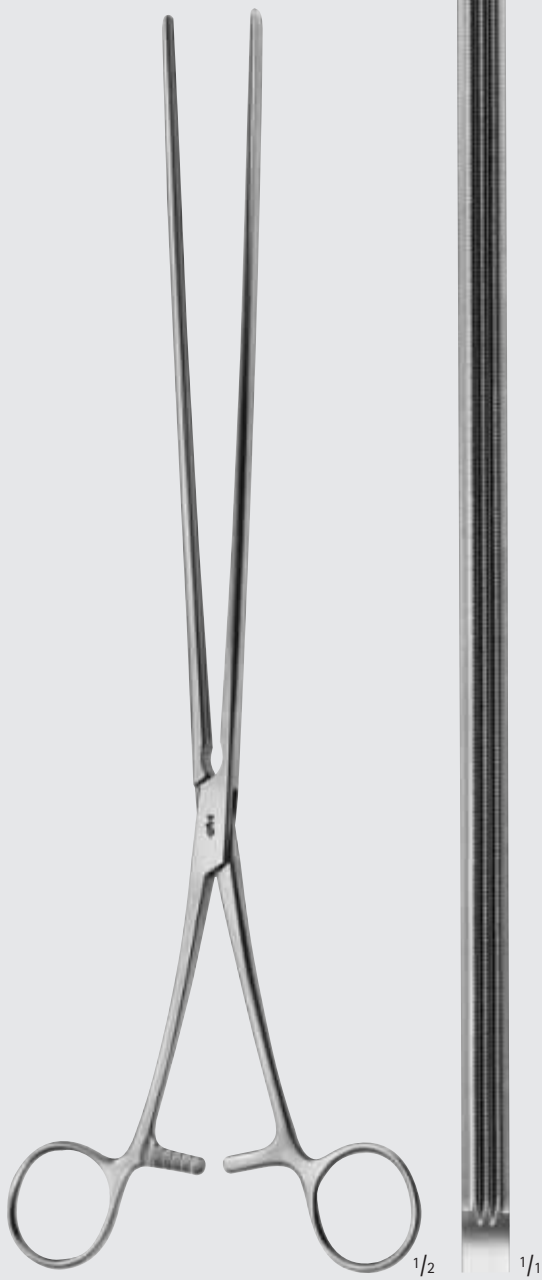

SCUDDER

EA240R

330 mm, 13"



KLEINSCHMIDT

EA397R

Spornquetschen und
Appendektomieklammern

Spur crushers and
Appendectomy clamps

130 mm, 5 1/8"



BENSON

EA466R

Pyloruspreizer

Pylorus spreader

155 mm, 6"



MILLIMETERS

Abdominale Chirurgie – Abdominal Surgery

Darm- und Magenquetschklemmen

Intestinal and Pylorus Clamps

EA



PAYR

EA305R

Darmquetschklemme,
leichtes Modell,
für Kinder

Intestinal clamp
light pattern,
for children

180 mm, 7"

PAYR

EA306R

200 mm, 8"

PAYR

EA309R

275 mm, 10 3/4"

PAYR

EA450R

Magenquetschklemme
Pylorus clamp

315 mm, 12 1/2"



Abdominale Chirurgie – Abdominal Surgery

Anastomosenklemmen Anastomosis Clamps

EA



DE MARTEL-WOLFSON

EA331R-EA332R

Anastomosenklemmen,
Satz zu 3 Stück

Anastomosis clamps,
set of 3 pieces

EA331R	EA332R
100 mm	120 mm
4"	4 3/4"



Klemmenhalter mit Klemmsatz
Clamp holder with set of clamps

EA334R-EA336R

Klemmenhalter
für EA331R, EA332R

Clamp holder
for EA331R, EA332R

EA334R	EA336R
80 mm	225 mm
3 1/8"	9"



DE MARTEL-WOLFSON

EA338R

Schließzange
für EA331R, EA332R

Closing forceps
for EA331R, EA332R
250 mm, 10"

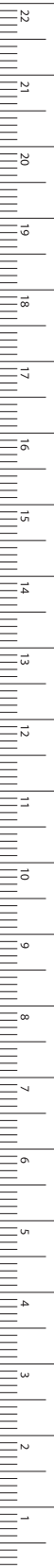

MILLIMETERS

Abdominale Chirurgie – Abdominal Surgery

Anastomosenklemmen

Anastomosis Forceps

EA

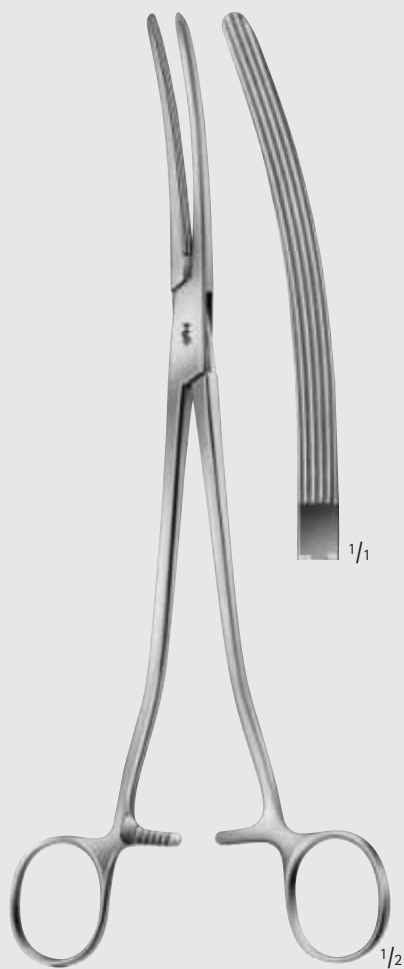

PARKER-KERR

EA365R

Anastomosenklemme für Colonresektion
Anastomosis forceps for colon resection
250 mm, 10"

ARAUMATA®

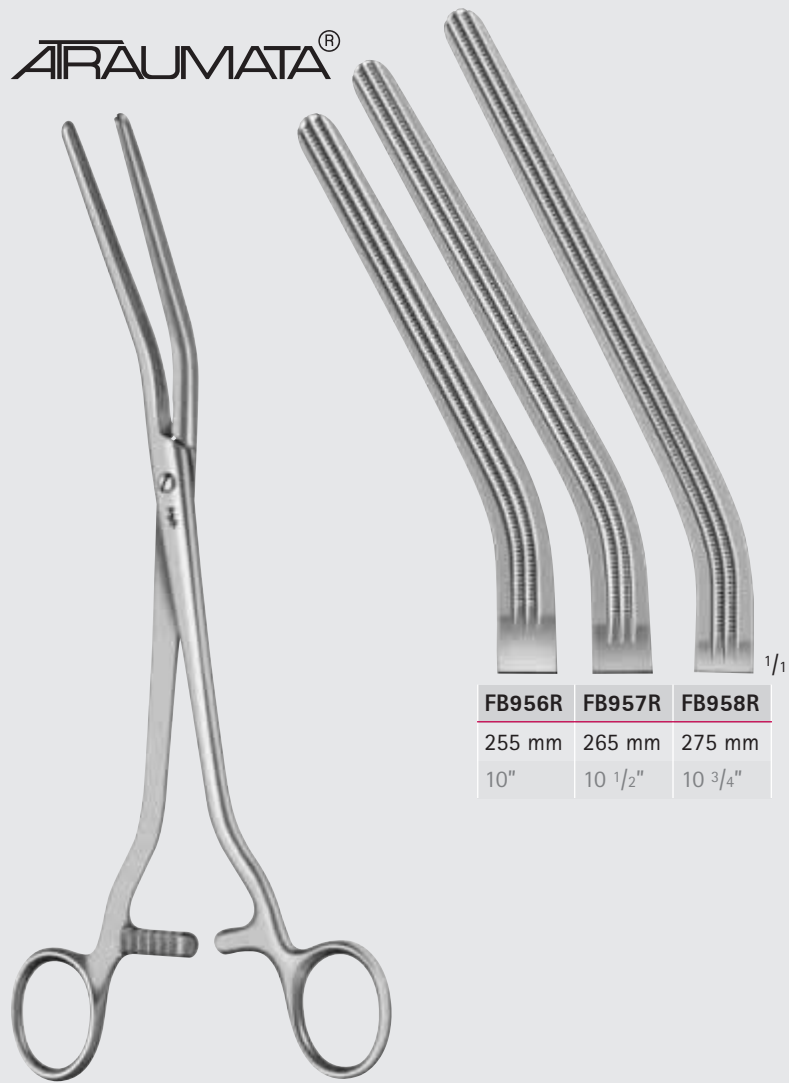

FB956R	FB957R	FB958R
255 mm	265 mm	275 mm
10"	10 1/2"	10 3/4"

DICK

FB956R-FB958R

Druckklemmen
Pressure clamps



Abdominale Chirurgie – Abdominal Surgery

Rektum-Anastomosenklemmen
Sigmoid Anastomosis Forceps

EA



BRUNNER

EA191R

245 mm, 9 3/4"



FB954R

60 mm

FB955R

80 mm

FB954R-FB955R

230 mm, 9"



MILLIMETERS

Abdominale Chirurgie – Abdominal Surgery

Rektum-Anastomosenklemmen

Sigmoid Anastomosis Forceps

EA

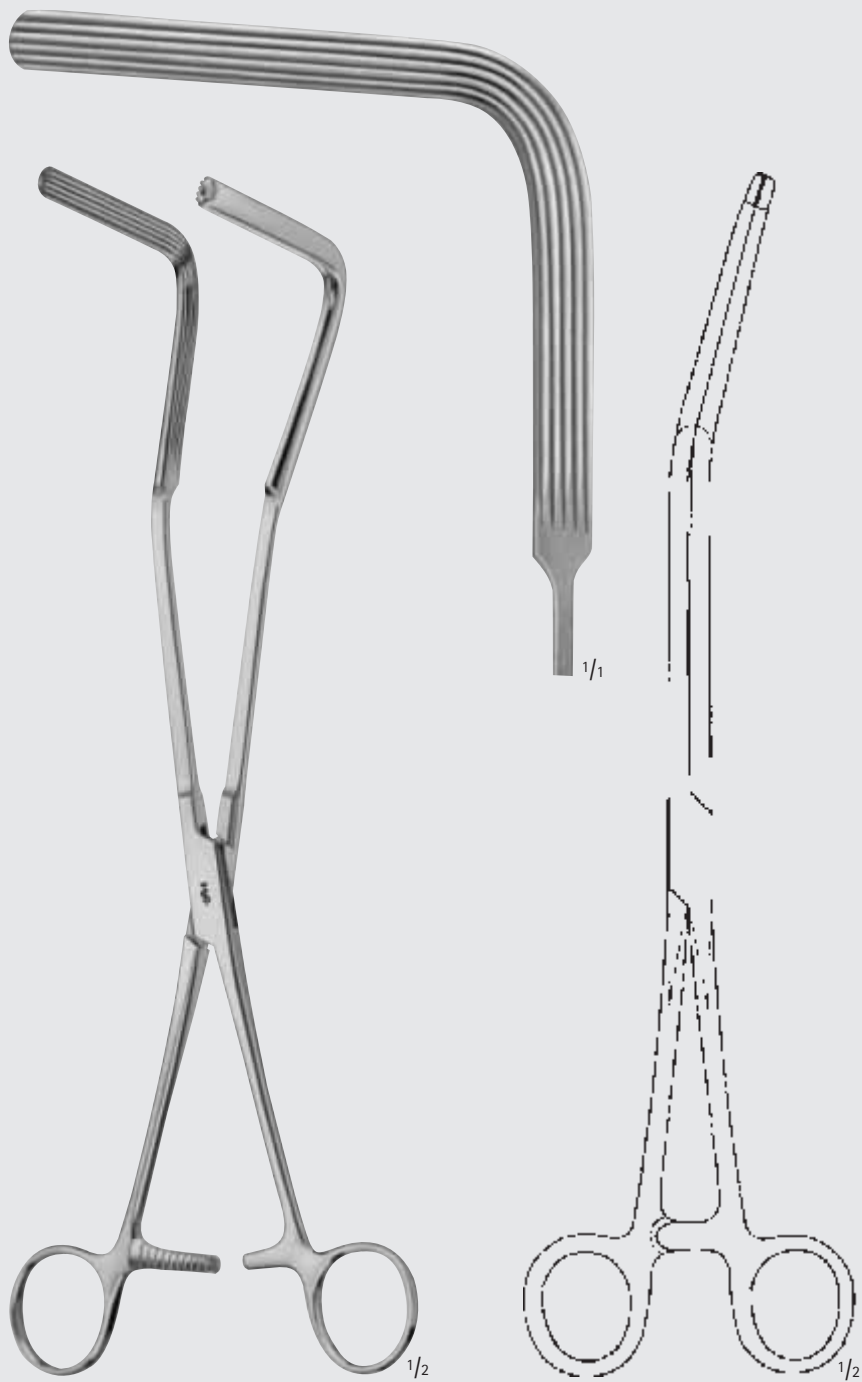
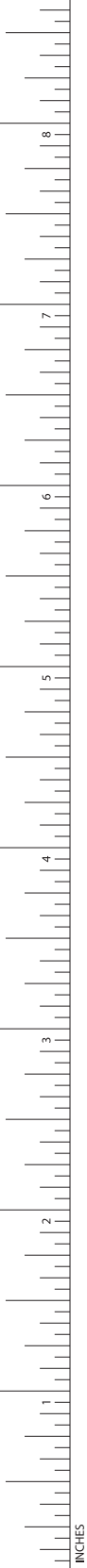

LLOYD-DAVIS

EA362R

315 mm, 12 1/2"



AIRAUMATA®

Abdominale Chirurgie – Abdominal Surgery
Rektum-Anastomosenklemmen
Sigmoid Anastomosis Forceps

EA

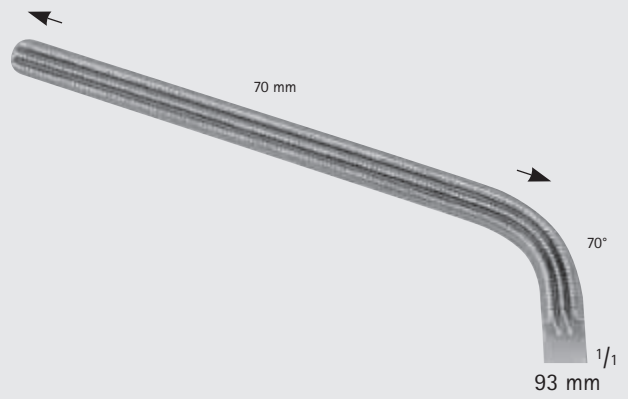
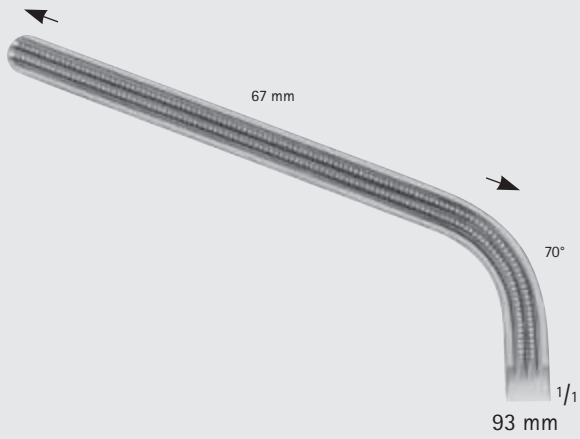

MORRIS

FB493R

175 mm, 7"

DE BAKEY
(MORRIS MODIF.)

FB494R

240 mm, 9"

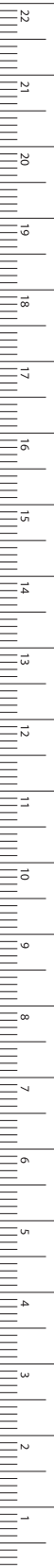

MILLIMETERS

Abdominale Chirurgie – Abdominal Surgery

Rektum-Anastomosenklemmen

Sigmoid Anastomosis Forceps

TRAUMATA®

EA

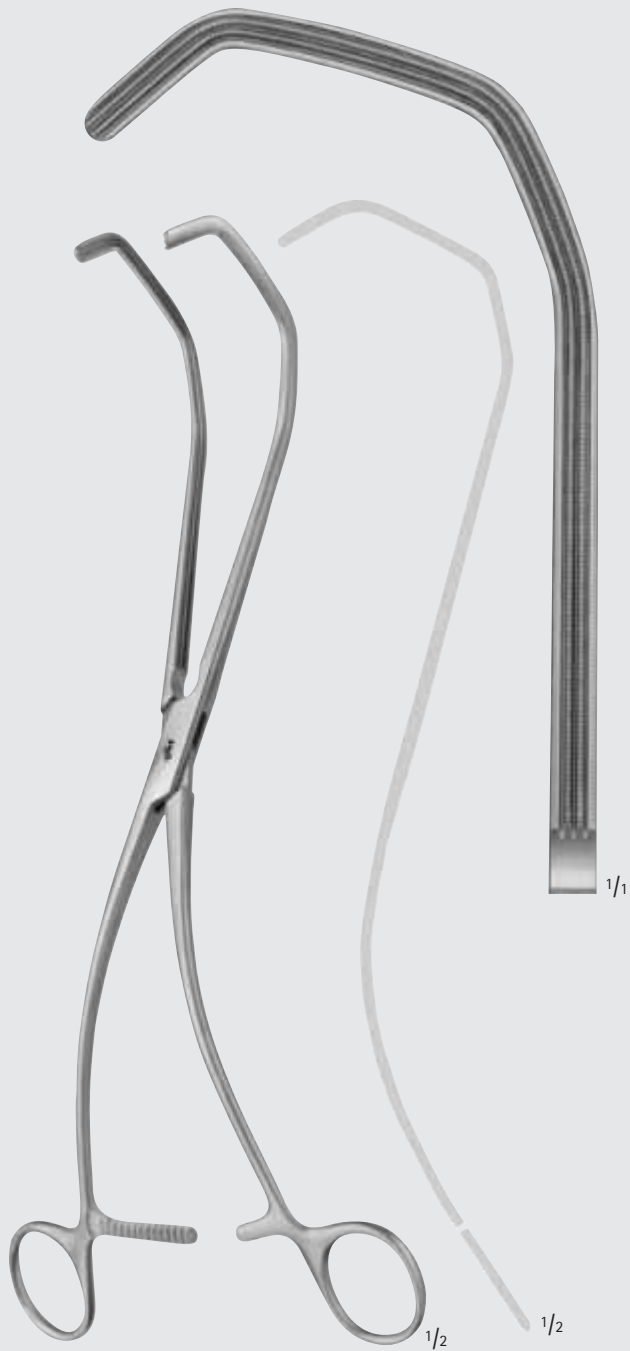

KERSTING

EA355R

300 mm, 12"



RESANO

EA360R

elastisch

elastic

265 mm, 10 1/2"



Abdominale Chirurgie – Abdominal Surgery

Rektum-Scheren

Rectal Scissors

EA



LLOYD-DAVIES
(GOLIGHER'S)

BC621R

270 mm, 10 ³/₄"

STELZNER

BC622R-BC623R

310 mm, 12 ³/₈"

BC617R

325 mm, 13"

MILLIMETERS

Abdominale Chirurgie – Abdominal Surgery

Instrumente zur tiefen Rektumchirurgie

Instruments for Deep Rectum Surgery

EA

AIRAUMATA®



MÜLLER

EA356R

Rektum-Anastomosenklemme

Rectal anastomosis clamp

375 mm, 15"



Abdominale Chirurgie – Abdominal Surgery

Instrumente zur tiefen Rektumchirurgie
Instruments for Deep Rectum Surgery

EA

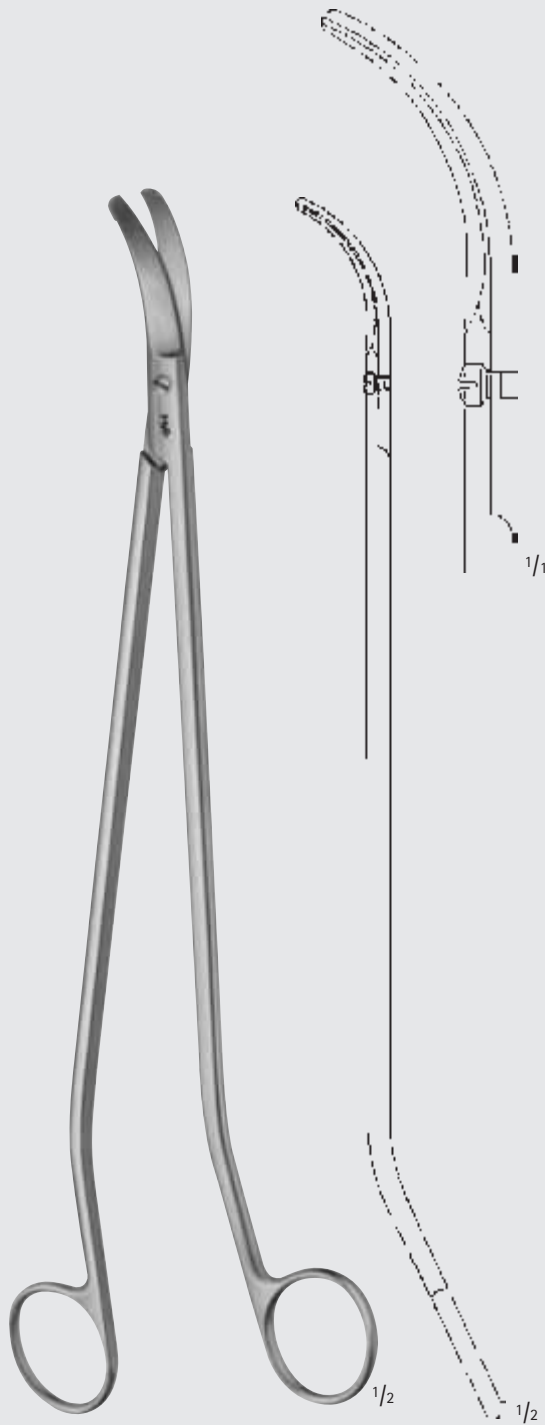

MÜLLER

BC627R

Rektumschere, s-förmig
Rectum scissors, s-shaped
325 mm, 13"

AIRAUMATA®



DE BAKEY

FB409R

350 mm, 14"



MILLIMETERS

Abdominale Chirurgie – Abdominal Surgery

Instrumente zur tiefen Rektumchirurgie

Instruments for Deep Rectum Surgery

EA



MÜLLER

BM089R

Nadelhalter

Needle holder

360 mm, 14"

AIRAUMATA®



ALLIS

EA100R

Fasszange

Grasping forceps

295 mm, 11 3/4"



Abdominale Chirurgie – Abdominal Surgery
Instrumente zur tiefen Rektumchirurgie
Instruments for Deep Rectum Surgery

EA



HÖSEL

BT446R

Wundhaken

Retractor

250 mm, 10"

MILLIMETERS

Abdominale Chirurgie – Abdominal Surgery

Mastdarm-Rektum-Spekula

Rectal Specula

EA



CZERNY
EA800R
225 mm, 9"



KILLIAN
OK093R
für Kinder
for children
145 mm, 5 1/2"



SIMS
EA820R
160 mm, 6 1/4"



SIMS
EA821R
160 mm, 6 1/4"



Abdominale Chirurgie – Abdominal Surgery

Mastdarm-Rektum-Spekula Rectal Specula

EA



EA825R-EA829R

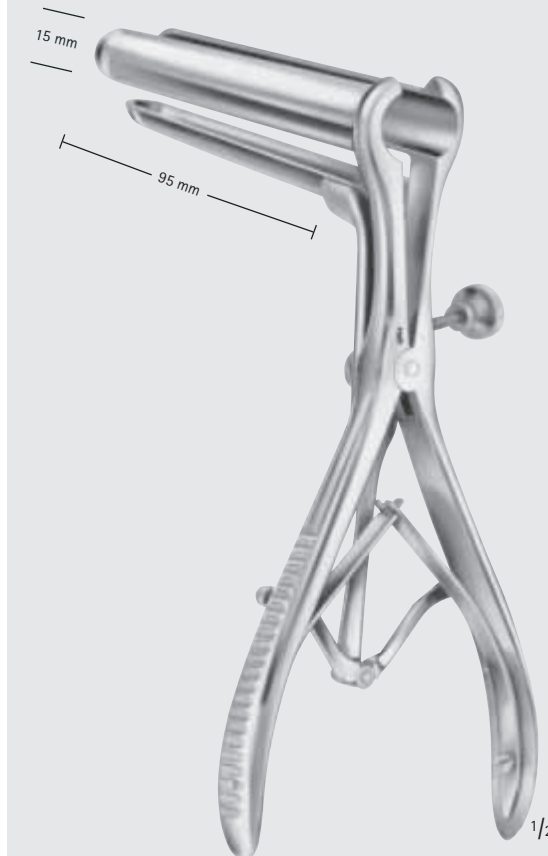
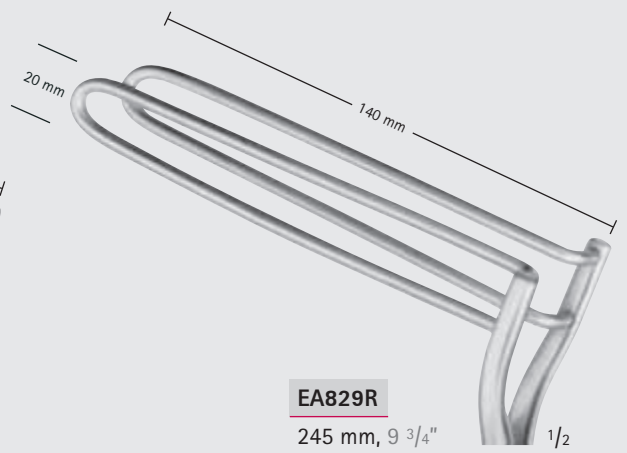
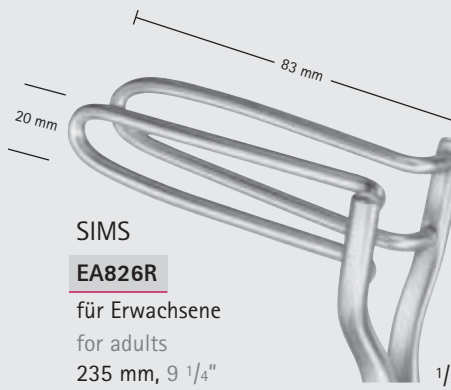
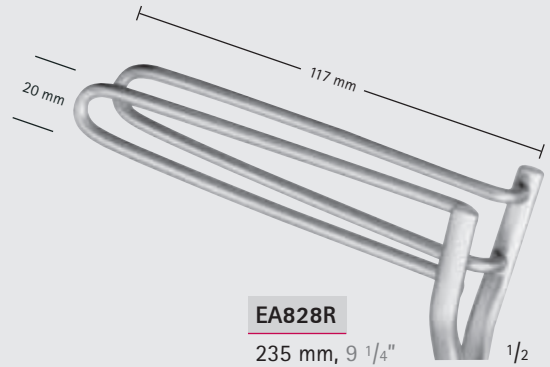
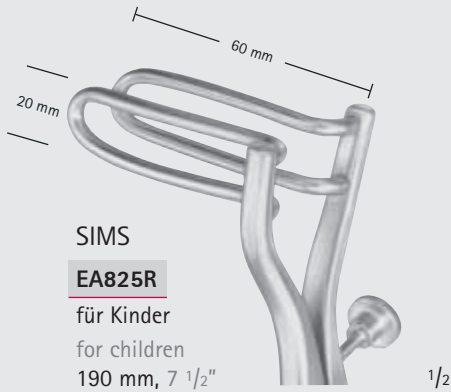

MILLIMETERS

Abdominale Chirurgie – Abdominal Surgery

Anuskope - Sphinkteroskope

Anusscopes - Sphincteroscopes

EA



BENSAUDE

EA862C-EA864C

Anuskope

Anusscopes

185 mm, 7 1/4"

Ø
diam.

EA862C 17 mm

EA863C 20 mm

EA864C 23 mm

1/2



IVES-FANSLER

EA880R

Anuskop, Ø 24 mm

Anuscope, diam. 24 mm

145 mm, 5 3/4"

1/2



KELLY

EA882R

Sphinkteroskop, Ø 20 mm

Anuscope, diam. 24 mm

160 mm, 6 1/4"

1/2



KELLY

EA883R

Sphinkteroskop, Ø 25 mm

Sphincteroscope, diam. 25 mm

160 mm, 6 1/4"

1/2





Abdominale Chirurgie – Abdominal Surgery

Protoskop – Analspreizer

Proctoscope - Rectal Retractor

EA

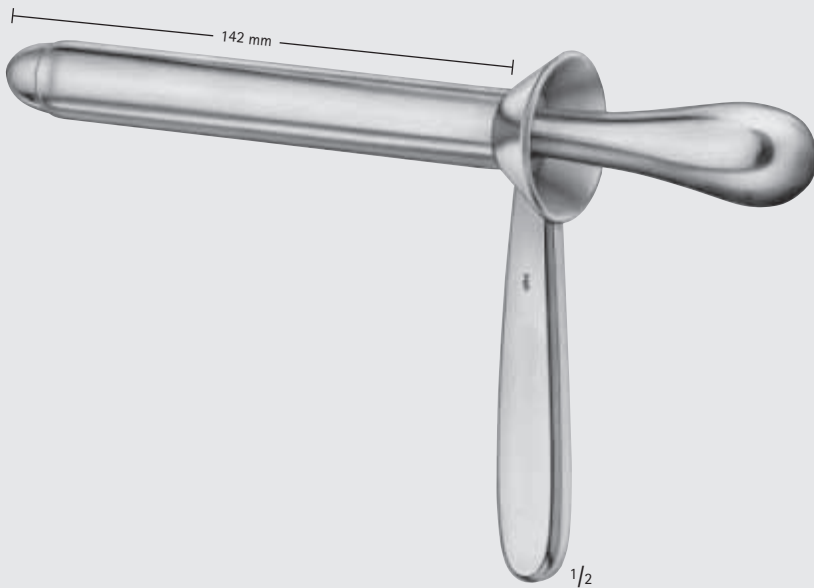

KELLY

EA887R

Proktoskop, Ø 20 mm

Proctoscope, diam. 20 mm

140 mm, 5 1/2"

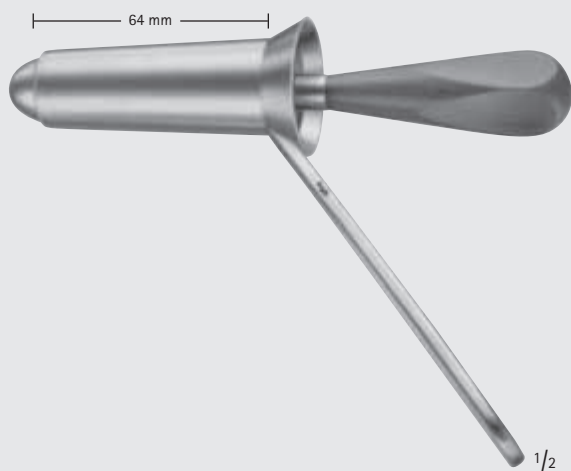

GABRIEL

EA853R

Rektum-Spekulum, Ø 25 mm

Rectal speculum, diam. 25 mm

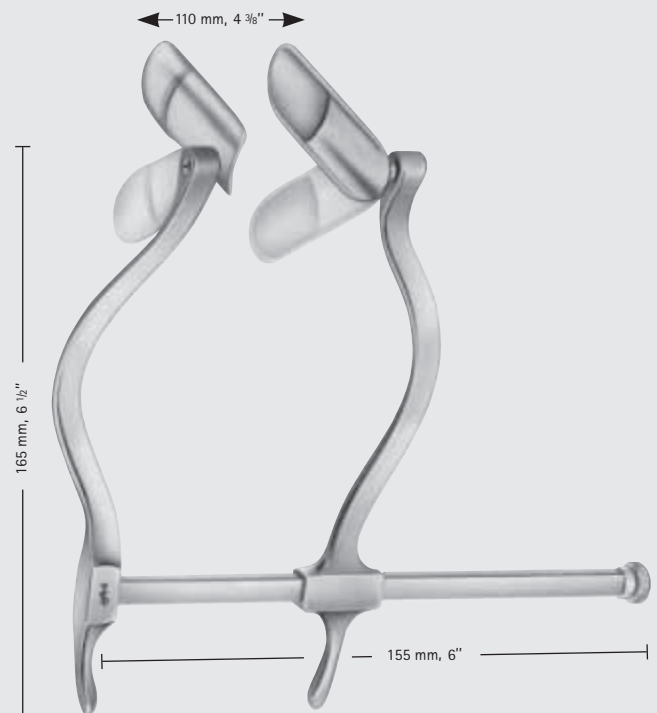

SMITH-BUIE

BV906R

Analspreizer

Blattgröße: 58 x 23 mm

Rectal retractor

Dimension of blades: 58 x 23 mm



MILLIMETERS

Abdominale Chirurgie – Abdominal Surgery

Rektum-Spekula

Rectal Specula

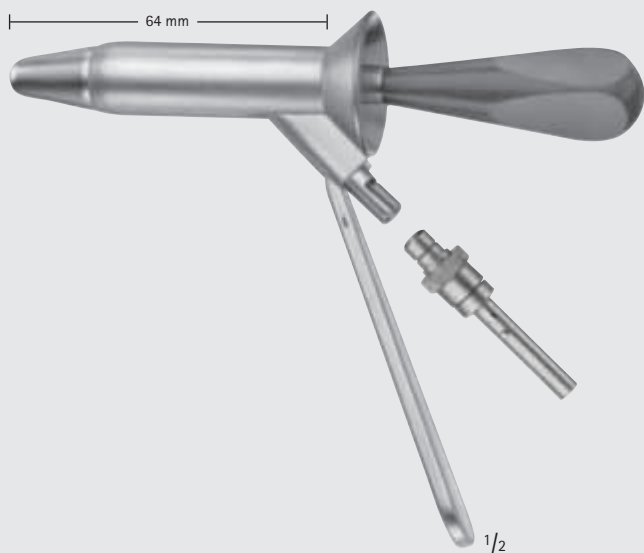

NAUNTON-MORGAN

EA871R-EA875R

Rektum-Spekula
mit Anschluss für Kaltlichtaufsatz EA876R

Rectal specula
with connector for fibre light attachment
EA876R

165 mm, 6 1/2"

Ø
diam.

EA871R	17 mm
EA873R	21 mm
EA875R	24 mm

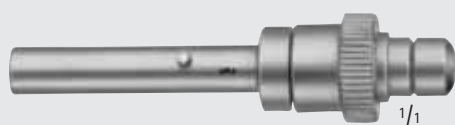

EA876R

Kaltlichtaufsatz, ACM/British Standard
zu NAUNTON-MORGAN Spekula

Fibre light attachment,
ACM/British Standard
for NAUNTON-MORGAN specula

EA



Abdominale Chirurgie – Abdominal Surgery

Sigmoidoskope und Proktoskope
Sigmoidoscope and Proctoscope

EA



LLOYD-DAVIES

EA888R

Ø 16 mm
250 mm, 9 ³/₄"



LLOYD-DAVIES

EA889R

Ø 20 mm
300 mm, 11 ³/₄"

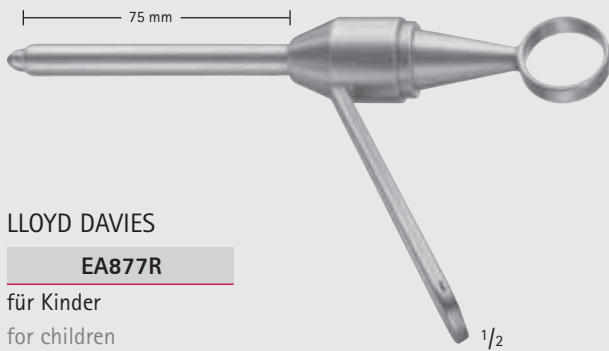

LLOYD DAVIES

EA877R

für Kinder
for children

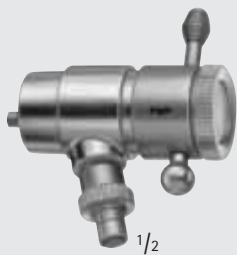

EA878R

Kaltlichtaufsatz, ACM/British Standard
zu EA887R, EA888R und EA889R
Fibre light attachment, ACM/British Standard
for EA887R, EA888R and EA889R



EA879R

Kaltlichtstab
Fibre light carrier

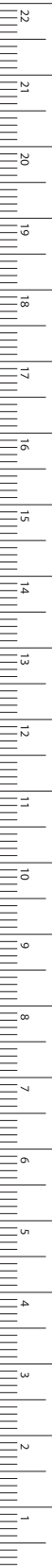

MILLIMETERS

Abdominale Chirurgie – Abdominal Surgery

Anal spreizer Rectal Spreader

 KUGELSCHNELLVERSCHLUSS
BALL SNAP CLOSURE

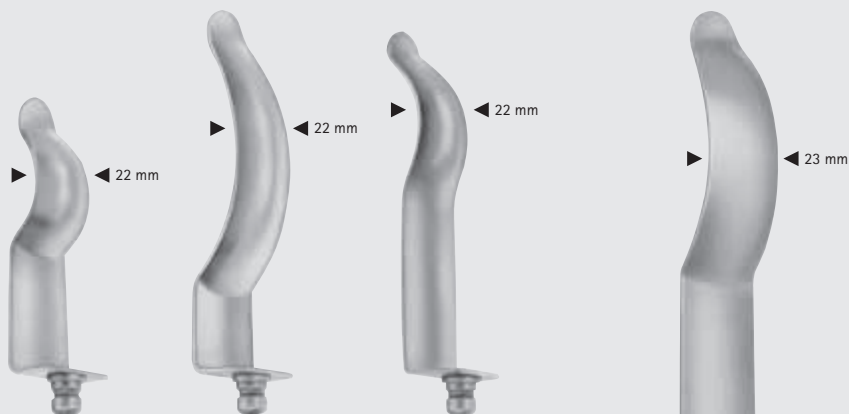

BV583R
Rektumblätter
70 mm tief
PAA = Paar
Rectal blades
70 mm deep
PAA = pair

BV584R
Spinkterblätter
93 mm tief
PAA = Paar
Sphincter blades
93 mm deep
PAA = pair

BV586R
Blätter für Anastomosen
90 mm tief
PAA = Paar
nicht in BV585R enthalten
Blades for anastomosis
90 mm deep
PAA = pair
not included in BV585R



PARKS
BV589R
150 mm tief
PAA = Paar
nicht in BV585R enthalten
150 mm deep
PAA = pair
not included in BV585R

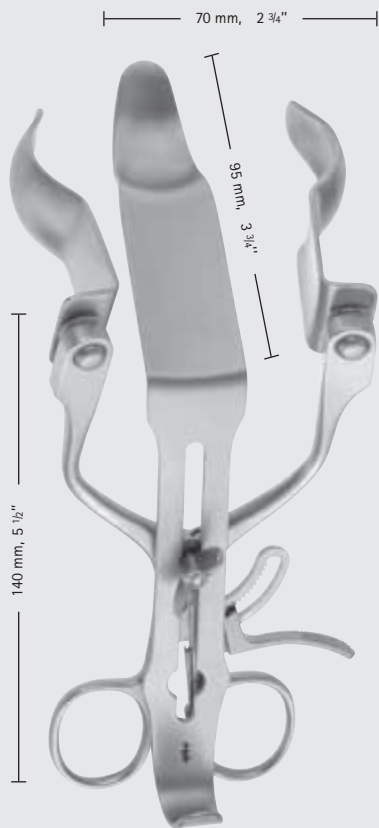

PARKS, MODIF. GIRONA

BV585R

Anal spreizer, komplett bestehend aus:
BV581R Sperrer, allein
BV582R Mittelblatt, allein
BV583R Paar Blätter, allein
BV584R Paar Blätter, allein
Rectal spreader, complete consisting of:
BV581R Spreader, only
BV582R Center blade, only
BV583R Pair of blades, only
BV584R Pair of blades, only



BV591R
Mittelblatt für Kaltlicht mit Aufnahme für Kaltlichtstab OP801
nicht in BV585R enthalten
Center blade with connection for cold light carrier OP801
not included in BV585R



OP801
Kaltlichtstab zur zusätzlichen, intensiven Ausleuchtung des OP-Feldes
Cold light carrier for additional, intensive illumination of the operating area

EA





Abdominale Chirurgie – Abdominal Surgery

Perineal Sperrer Perineal Retractor



KUGELSCHNELLVERSCHLUSS
BALL SNAP CLOSURE

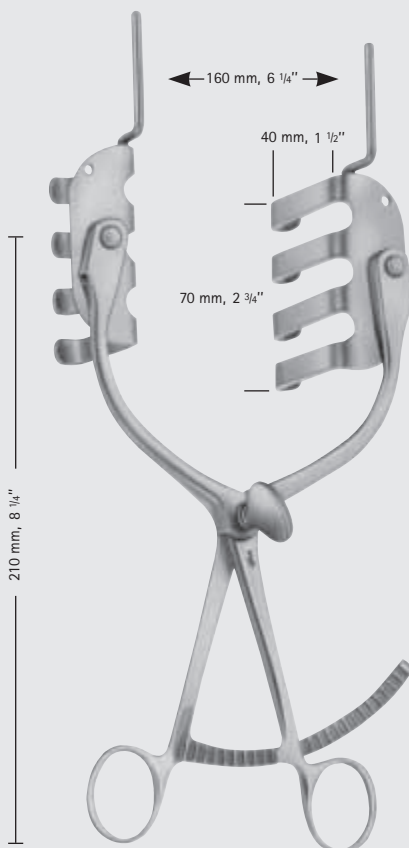

ST. MARKS, MODIF. GIRONA

BV907R

Perineal Sperrer mit
Tuchhaltestift an den Blättern
Perineal retractor with towel pegs
fitted to swivel rake blades

EA

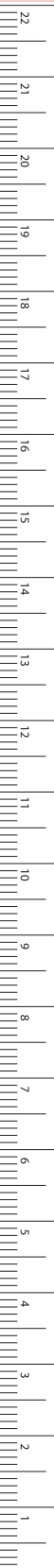

MILLIMETERS

Abdominale Chirurgie – Abdominal Surgery

Pelvishaken

Pelvis Retractors

EA



ST. MARKS

BT670R

290 mm, 11 1/2"

ST. MARKS

BT672R

330 mm, 13 1/8"

ST. MARKS

BT674R

330 mm, 13 1/8"



Abdominale Chirurgie – Abdominal Surgery

Analsonden
Rectal Probes

EA

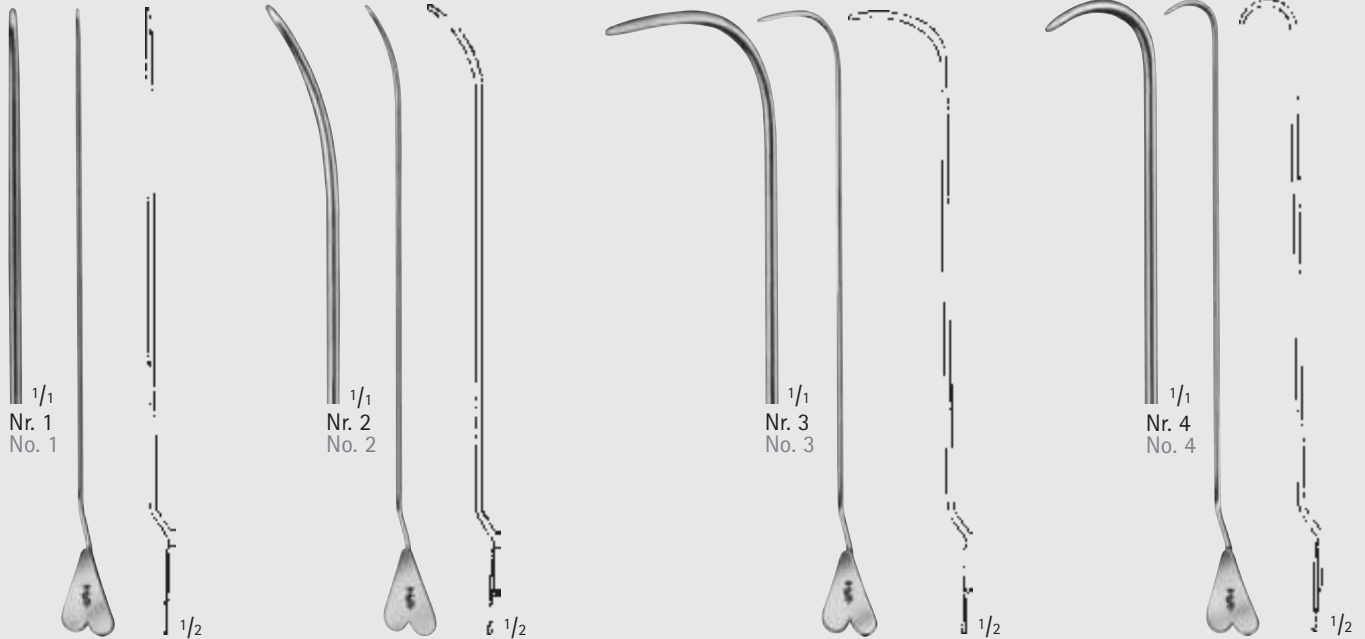

LOCKHART-MUMMERY

BN021R-BN024R

Fistelsonden
Fistula probes
165 mm, 6 1/2"

BN021R	Nr. 1	gerade	No. 1	straight
BN022R	Nr. 2	45° gebogen	No. 2	45° curved
BN023R	Nr. 3	90° gebogen	No. 3	90° curved
BN024R	Nr. 4	retrograd gebogen	No. 4	retrograde curved

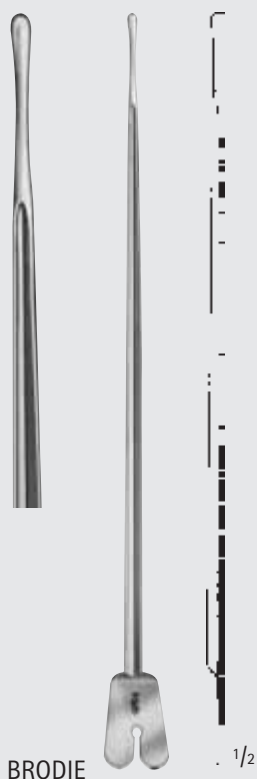

BRODIE

BN020R

Hohlsonde mit Knopf,
Knopf-Ø: 3,5 mm
Director with tip,
diam. of tip: 3.5 mm
200 mm, 8"

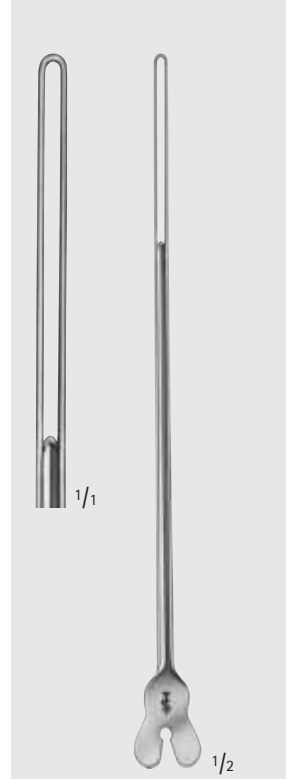

BN026R

Ösenrinnensonde,
biegsam
Director with wire loop,
malleable
190 mm, 7 1/2"

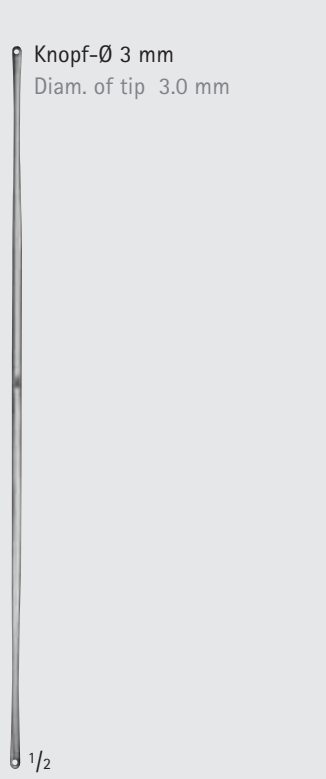

Knopf-Ø 3 mm
Diam. of tip 3.0 mm

BN090R

Doppelknopfsonde,
biegsam, mit Loch
Double ended probe,
malleable, with hole
190 mm, 7 1/2"

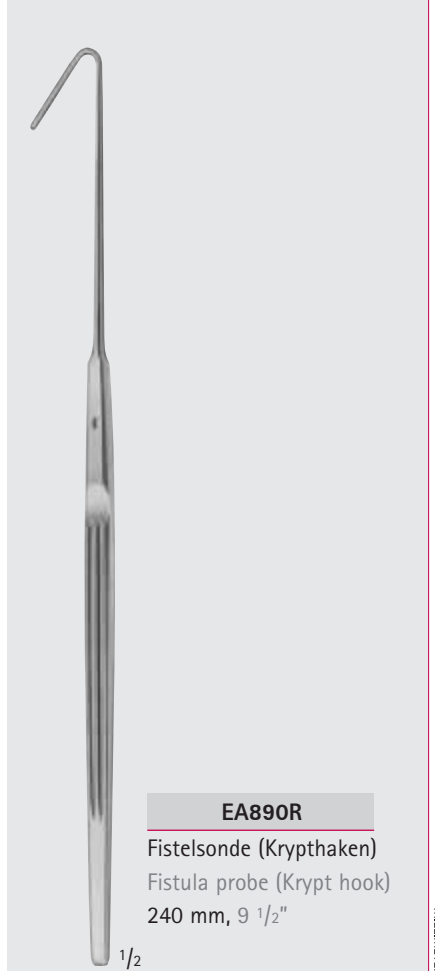

EA890R

Fistelsonde (Krypthaken)
Fistula probe (Krypt hook)
240 mm, 9 1/2"



MILLIMETERS

Abdominale Chirurgie – Abdominal Surgery

Biopsiezangen für Rektum

Biopsy Forceps for Rectum

EA

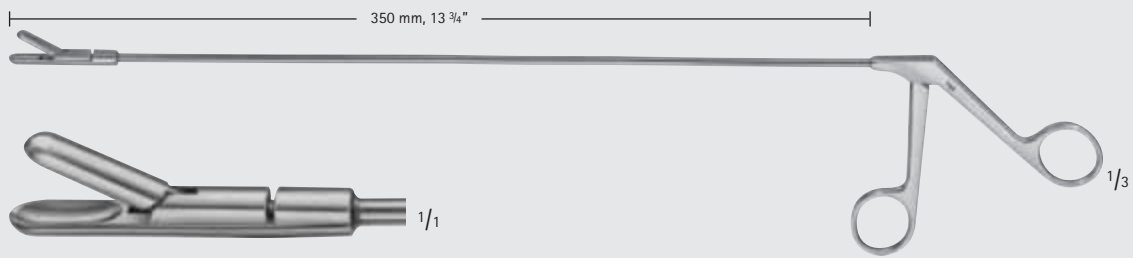

LLOYD-DAVIS

EA900R

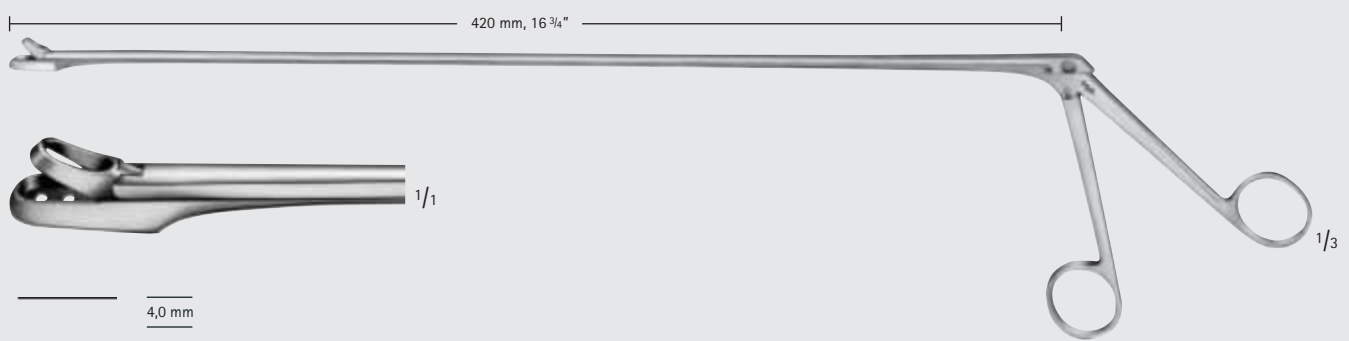

YEOMAN

EA903R



Abdominale Chirurgie – Abdominal Surgery

Biopsiezangen für Rektum Biopsy Forceps for Rectum

EA

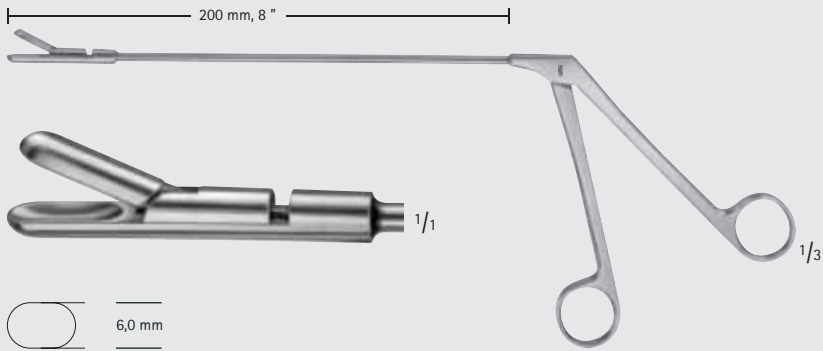

WALTON

EA904R

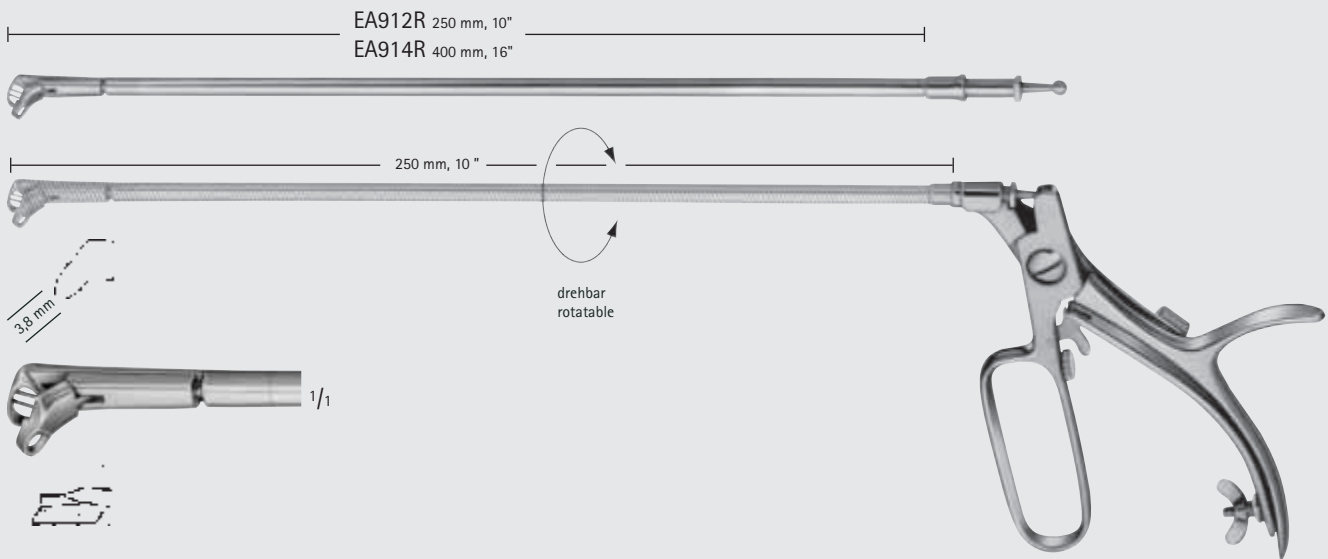

AESCULAP

OP151R

Griff für EA912R – EA914R
Handle for EA912R – EA914R
140 mm, 5 1/2"

EA912R-EA914R

Aufsätze allein
mit ziehendem Schnitt
Attachments only
with cut beginning
from the top

EA914R	EA912R
400 mm	250 mm
16"	10"



MILLIMETERS

Abdominale Chirurgie – Abdominal Surgery

Biopsiezangen und Tamponhalter für Rektum

Biopsy Forceps and Swab Holders for Rectum

EA

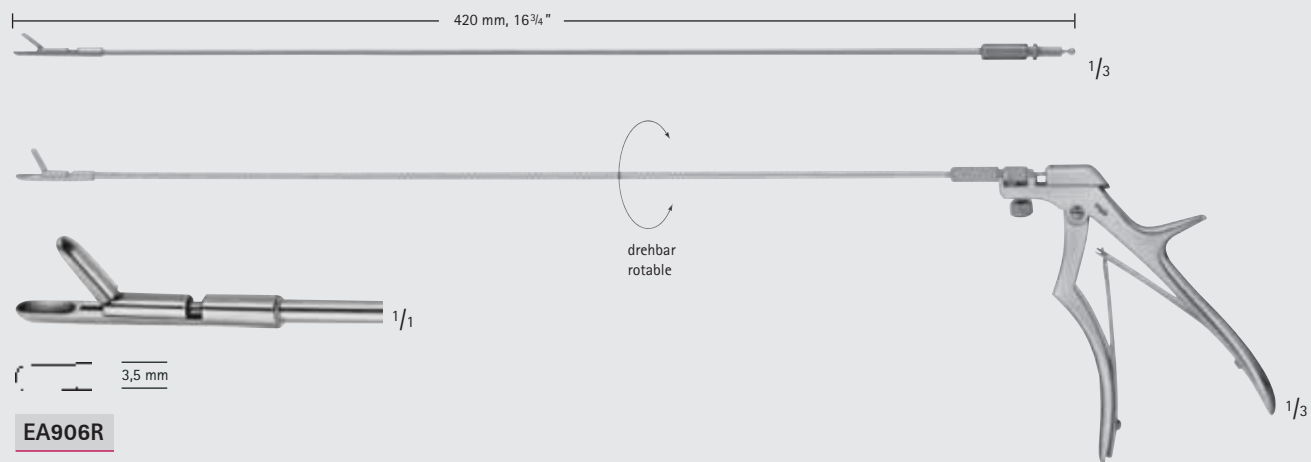

EA905R

Griff für
EA906R - EA909R
Handle
for EA906R - EA909R

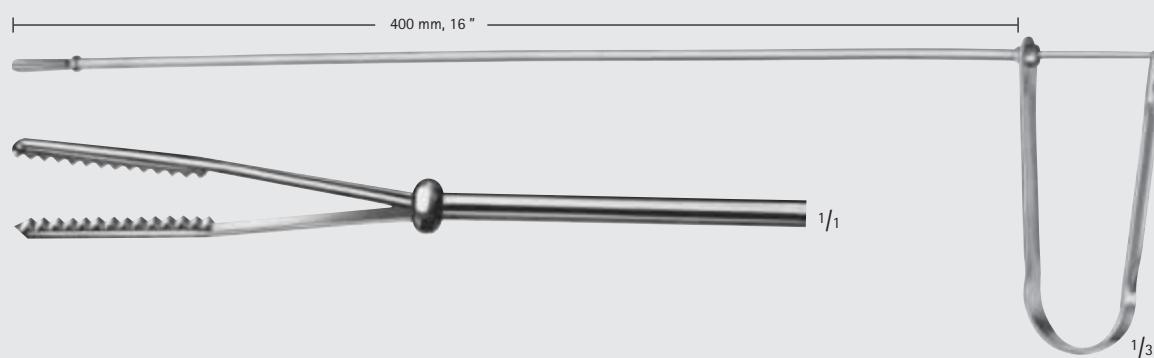
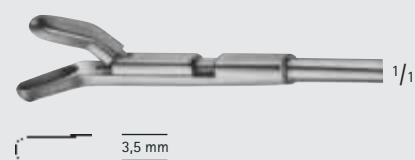

AESCULAP

EA943R

Tamponhalter
Swab holder

Abdominale Chirurgie – Abdominal Surgery
Hämorrhoidenklemmen
Hemorrhoidal Forceps

EA

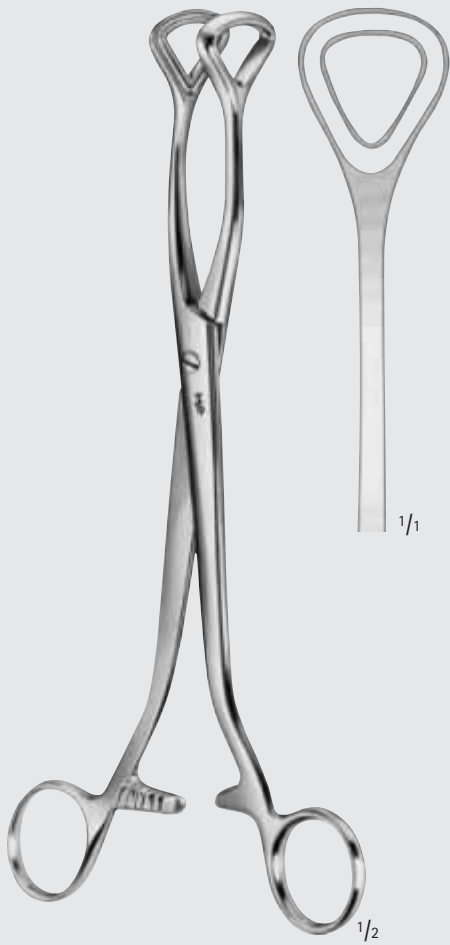

LUER

EA989R

245 mm, 9 3/4"

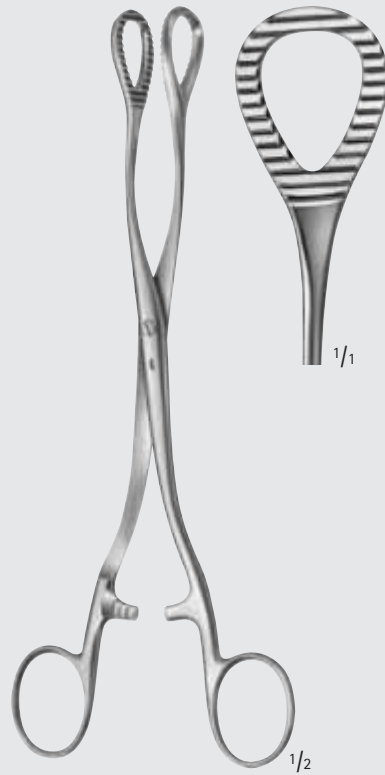

HEYWOOD-SMITH

AN710R

200 mm, 8"

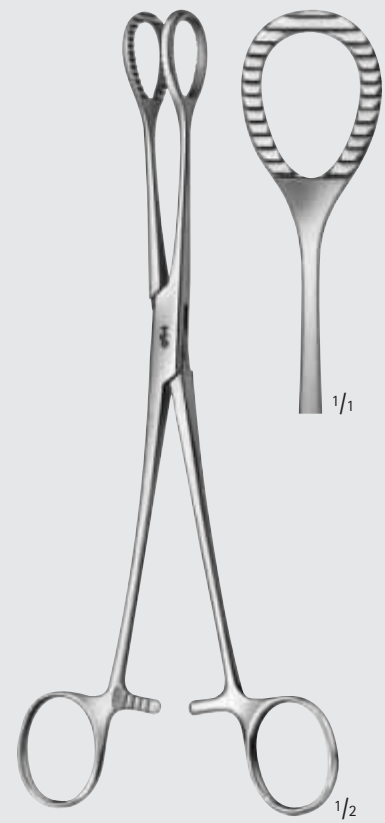

HEYWOOD-SMITH MODIF.

AN711R

215 mm, 8 1/2"

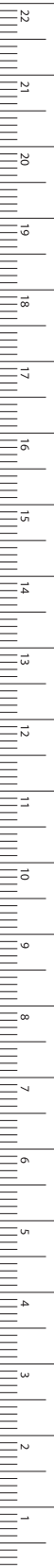

MILLIMETERS

Abdominale Chirurgie – Abdominal Surgery

Hämorrhoidenklemmen

Hemorrhoidal Forceps

EA



AIRAUMATA®



E0338R

250 mm

10"



E0340R

270 mm

10 3/4"

E0338R-E0340R



VC100R

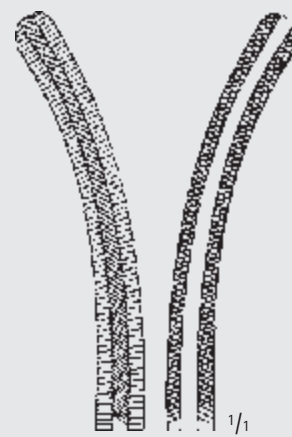

VC101R

FERGUSSON

VC100R-VC101R

Druckklemmen
Pressure clamps

200 mm, 8"



Abdominale Chirurgie – Abdominal Surgery

Hämorrhoidal-Ligator Hemorrhoidal Ligator

EA



RUDD

EA991R

Hämorrhoidal-Ligator
mit Lade-Aufsatz und
100 Ligatur-Gummiringen
Hemorrhoidal ligator
with loading attachment
and 100 ligature rubber rings
315 mm, 12 1/2"



MC GIVNEY

EA990R

Hämorrhoiden-Fasszange
Hemorrhoidal forceps
185 mm, 7 1/4"



EA993

Ligatur-Gummiringe
Bestelleinheit:
PAK = Packung à 100 Stück
Ligature rubber rings
Sales Unit:
PAK = Package of 100 pieces



MILLIMETERS

Abdominale Chirurgie – Abdominal Surgery

Hämorrhoidal-Ligator

Hemorrhoidal Ligator

EA

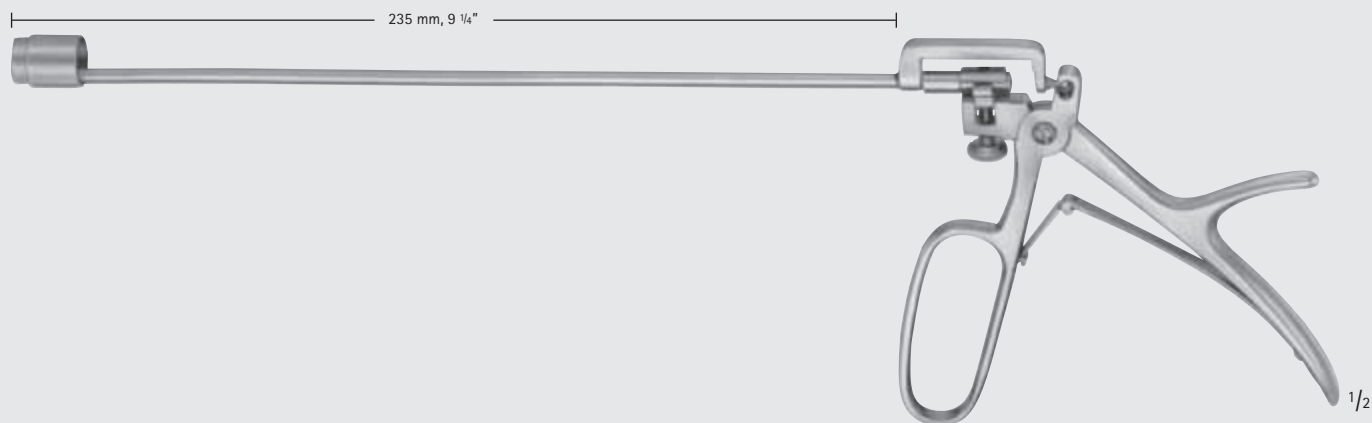

BARRON

EA996R

Hämorrhoidal-Ligator, komplett

bestehend aus:

EA997R Schaft, allein

EA998R Universal-Handgriff

EA999P Ladekonus

Hemorrhoidal ligator, complete

consisting of:

EA997R Shaft, only

EA998R Universal handle

EA999P Conical loader

Passende Ligatur-Gummiringe: EA993 (siehe Seite 585)

Suitable ligature rubber rings: EA993 (see page 585)



Abdominale Chirurgie – Abdominal Surgery

Hämorrhoidal-Spritze, Hämorrhoidal-Kanüle
Hemorrhoidal Syringe, Hemorrhoidal Cannula

EA



GABRIEL

SF462

Hämorrhoidal-Spritze
Hemorrhoidal syringe
10 ml

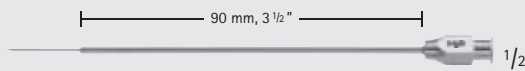

GABRIEL

SF835

Hämorrhoidal-Kanüle, gerade,
mit Luer-Lock-Ansatz
Hemorrhoidal cannula, straight,
with Luer-Lock attachment

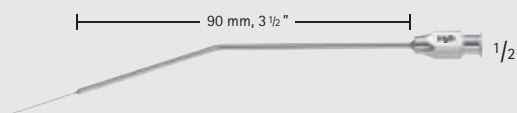

GABRIEL

SF836

Hämorrhoidal-Kanüle, abgewinkelt,
mit Luer-Lock-Ansatz
Hemorrhoidal cannula, angled,
with Luer-Lock attachment

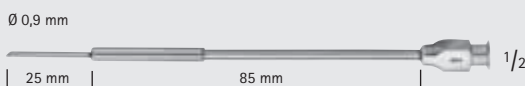

SF818R

Hämorrhoiden-Kanüle, mit
Luer-Lock-Ansatz
Hemorrhoidal cannula,
with Luer-Lock attachment





INCHES

EB



Instrumente für Galle, Leber und Milz

Gall Bladder-, Liver- and Spleen Instruments

Instrumente für Galle, Leber – Gall Bladder-, Liver-Instruments

Gallenkanal-Klemmzangen

Gall Duct Forceps

Klemmen nach OVERHOLT siehe Rubrik BJ

OVERHOLT Forceps see section BJ

EB





Instrumente für Galle, Leber – Gall Bladder-, Liver-Instruments

Gallenkanal-Klemmzangen Gall Duct Forceps

Klemmen nach OVERHOLT siehe Rubrik BJ
OVERHOLT Forceps see section BJ

EB



DESJARDINS

EB008R

Gallenkanal- und Cystikusklammer
Gall duct- and cystic forceps
220 mm, 8 3/4"

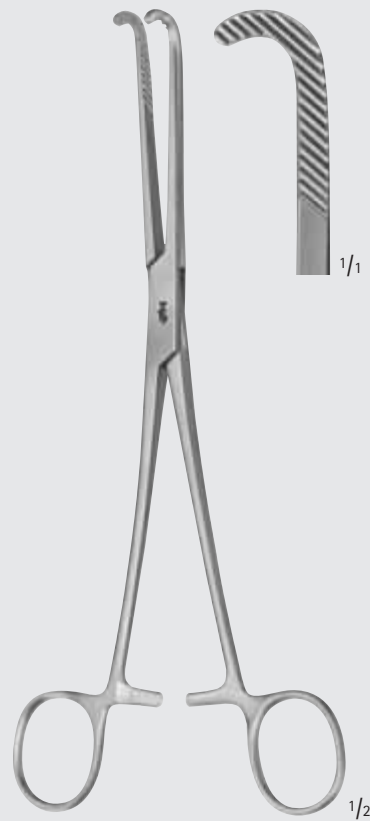

NISSEN

EB009R

Gallenkanal- und Cystikusklammer
Gall duct- and cystic forceps
215 mm, 8 1/2"



MILLIMETERS

Instrumente für Galle, Leber – Gall Bladder-, Liver-Instruments

Gallenkanal-Klemmzangen

Gall Duct Forceps

EB



MOYNIHAN

BH831R-BH833R

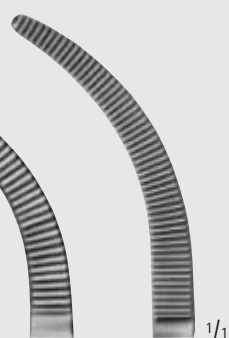

BH831R

230 mm

9"

BH833R

240 mm

9 1/2"

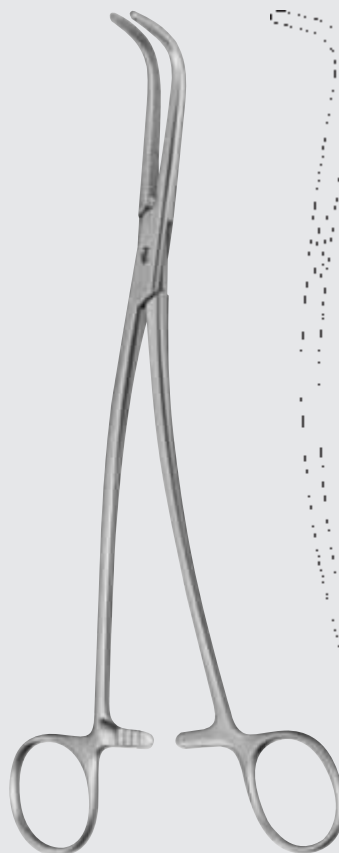

GRAY

EB011R-EB012R

Cholecystektomieklammen

Cholecystectomy forceps

220 mm, 8 3/4"

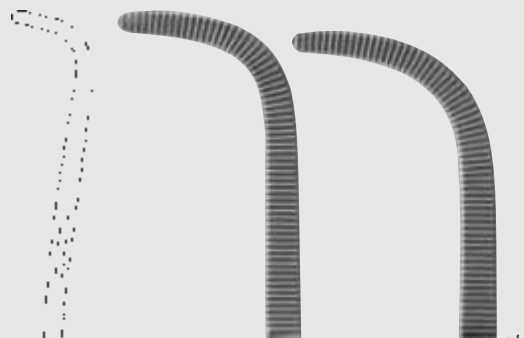

EB011R

EB012R



Instrumente für Galle, Leber – Gall Bladder-, Liver-Instruments
Gallenkanal-Klemmzangen
Gall Duct Forceps

EB

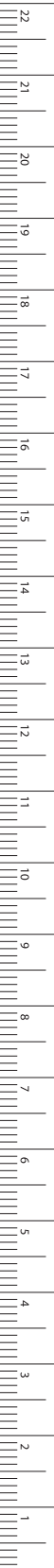

MILLIMETERS



MIXTER

BJO55R

Gallenkanal- und Cystikusklammer
Gall duct- and cystic forceps
230 mm, 9"

Instrumente für Galle, Leber – Gall Bladder-, Liver-Instruments

Gallenblasenzangen

Gall Bladder Forceps

EB



BF122R

BF123R

FOERSTER-BALLENGER

BF122R-BF123R

245 mm, 9 3/4"

1/2

1/1

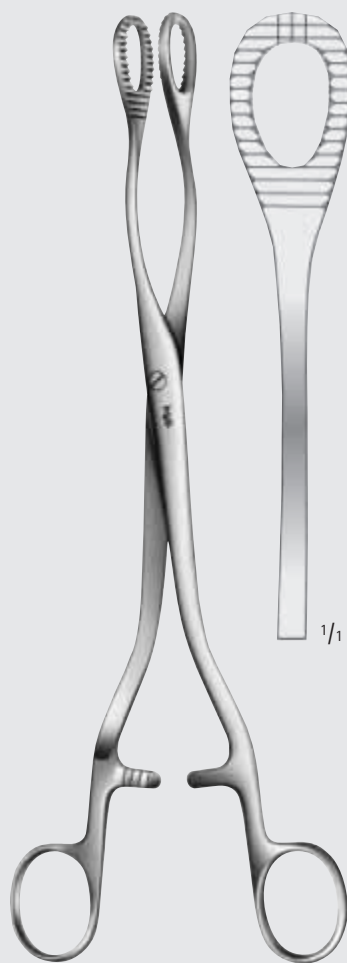

1/1

HEYWOOD-SMITH

E0310R

250 mm, 10"

1/2



Instrumente für Galle, Leber – Gall Bladder-, Liver-Instruments
Gallenblasenzangen
Gall Bladder Forceps

EB

AIRAUMATA®



E0338R
250 mm
10"

E0340R
270 mm
10 3/4"

E0338R-E0340R



HEYWOOD-SMITH

AN710R

200 mm, 8"



MILLIMETERS

Instrumente für Galle, Leber – Gall Bladder-, Liver-Instruments

Gallenblasenzangen und Gallengangscheren

Gall Bladder Forceps and Gall Duct Scissors

EB

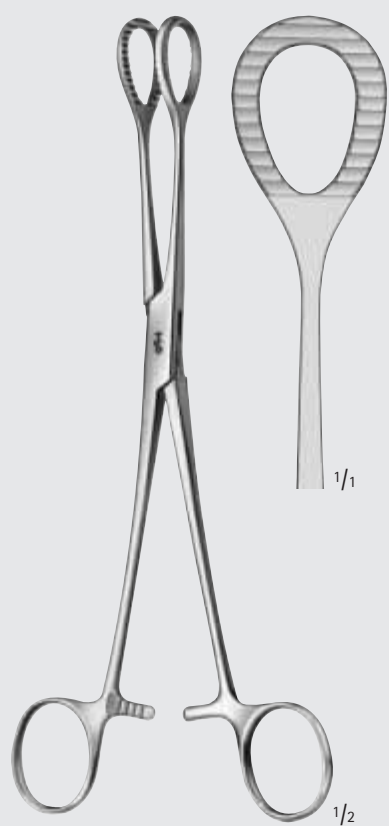

HEYWOOD-SMITH MODIF.

AN711R

215 mm, 8 1/2"

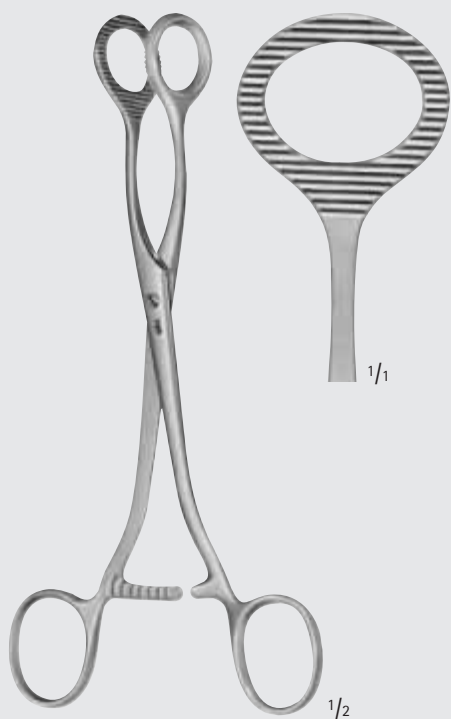

DOYEN

E0332R

185 mm, 7 1/4"

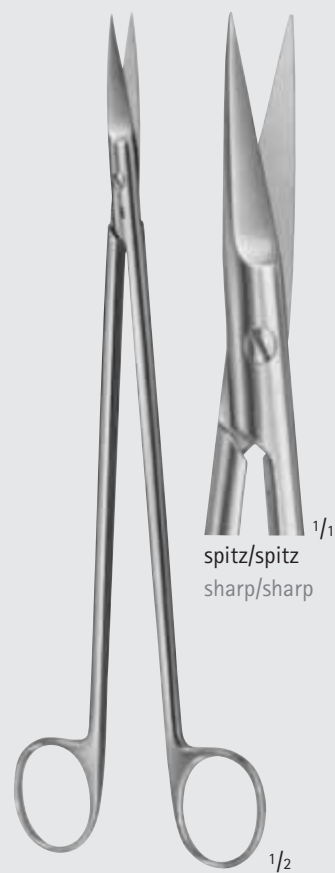

spitz/spitz
sharp/sharp

BC642R

zur Eröffnung
der Gallenblase
for opening the
gall bladder
225 mm, 9"



Instrumente für Galle, Leber – Gall Bladder-, Liver-Instruments

Gallengangsscheren
Gall Duct Scissors

EB



POTTS-DE MARTEL

BC650R

60°

MILLS ^{1/1}

BC651R

60°

^{1/2}

BC650R-BC651R

220 mm, 8 ^{3/4}"

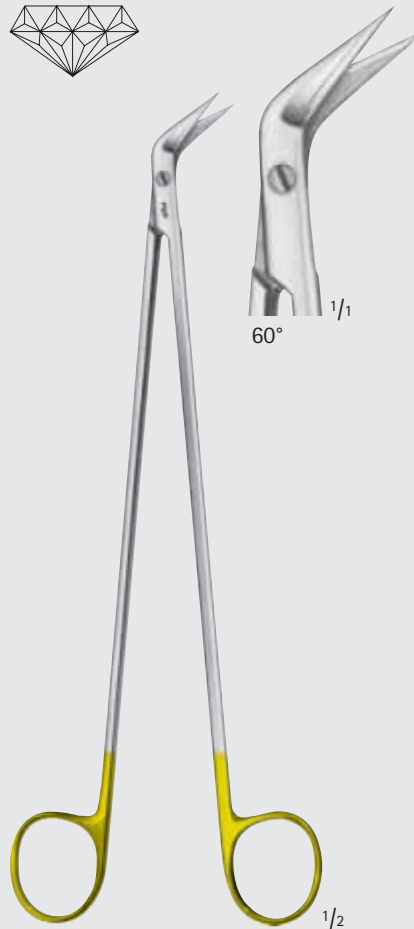

60°

^{1/1}

^{1/2}

DE BAKEY

BC245R

220 mm, 8 ^{3/4}"

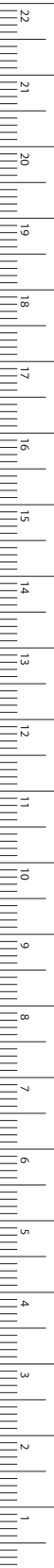

MILLIMETERS

Instrumente für Galle, Leber – Gall Bladder-, Liver-Instruments

Gallengangsonden

Gall Duct Probes

EB



Knopf-Ø 3,5 mm
Diam. of tip 3.5 mm



HAJEK

OK900

Spülkanüle, aus Silber
Irrigating cannula, silver
165 mm, 6 1/2"

Knopf-Ø 5 mm
Diam. of tip 5 mm



MOYNIHAN

EB050

Gallensteinsonde und -löffel
aus Zinn, biegsam
Gall stone probe and -scoop
of tin, malleable
365 mm, 14 1/2"

Knopf-Ø 5 mm
Diam. of tip 5 mm



MAYO

EO005R

Gallengangsonde, biegsam
Gall duct probe, malleable
330 mm, 13 1/8"



Instrumente für Galle, Leber – Gall Bladder-, Liver-Instruments

Gallengansonden
Gall Duct Probes

Knopf-Ø 3,5 mm
Diam. of tip 3.5 mm

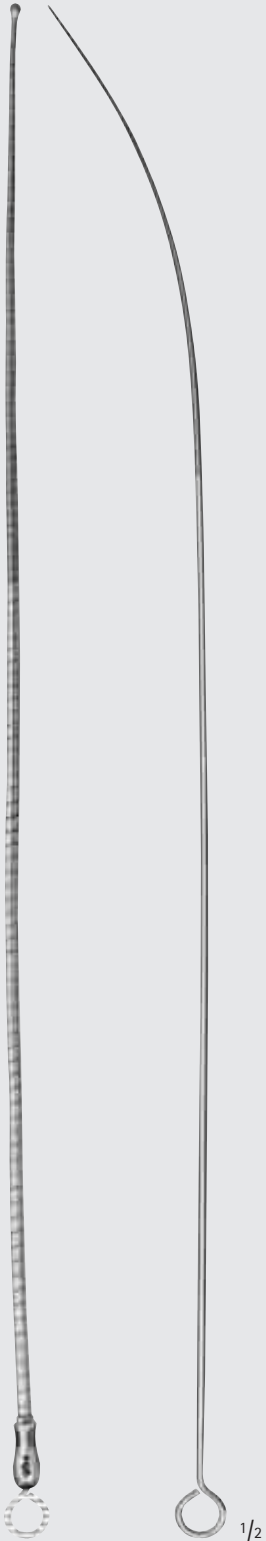

OCHSNER

EB052C

Gallengangsonde, federnd
Gall duct probe, flexible
400 mm, 16"



	EB101R	EB102R	EB103R
Knopf-Ø	3,8 mm	5,3 mm	6,8 mm
Diam. of tip	3.8 mm	5.3 mm	6.8 mm

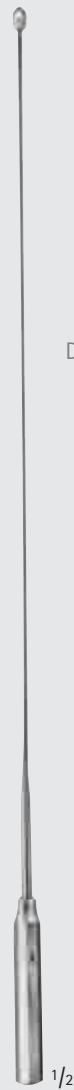

DESJARDINS

EB101R-EB103R

Gallengangsonden, federnd
Gall duct probes, flexible
285 mm, 11 1/4"

EB

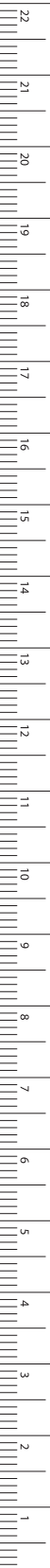

MILLIMETERS

Instrumente für Galle, Leber – Gall Bladder-, Liver-Instruments

Gallengangdilatatoren

Gall Duct Dilators

EB



Charr. (French)

EF638R	8
EF639R	9
EF640R	10
EF641R	11
EF642R	12
EF643R	13
EF644R	14
EF645R	15
EF646R	16
EF647R	17
EF648R	18
EF649R	19
EF650R	20
EF651R	21
EF652R	22
EF653R	23
EF654R	24
EF655R	25
EF656R	26
EF657R	27
EF658R	28
EF659R	29
EF660R	30

DITTEL

EF638R-EF660R

Metallbougie-Öffner

Metal bougies
and dilating sounds

345 mm, 13 3/4"

1/2

Instrumente für Galle, Leber – Gall Bladder-, Liver-Instruments

Gallengangdilatoren Gall Duct Dilators

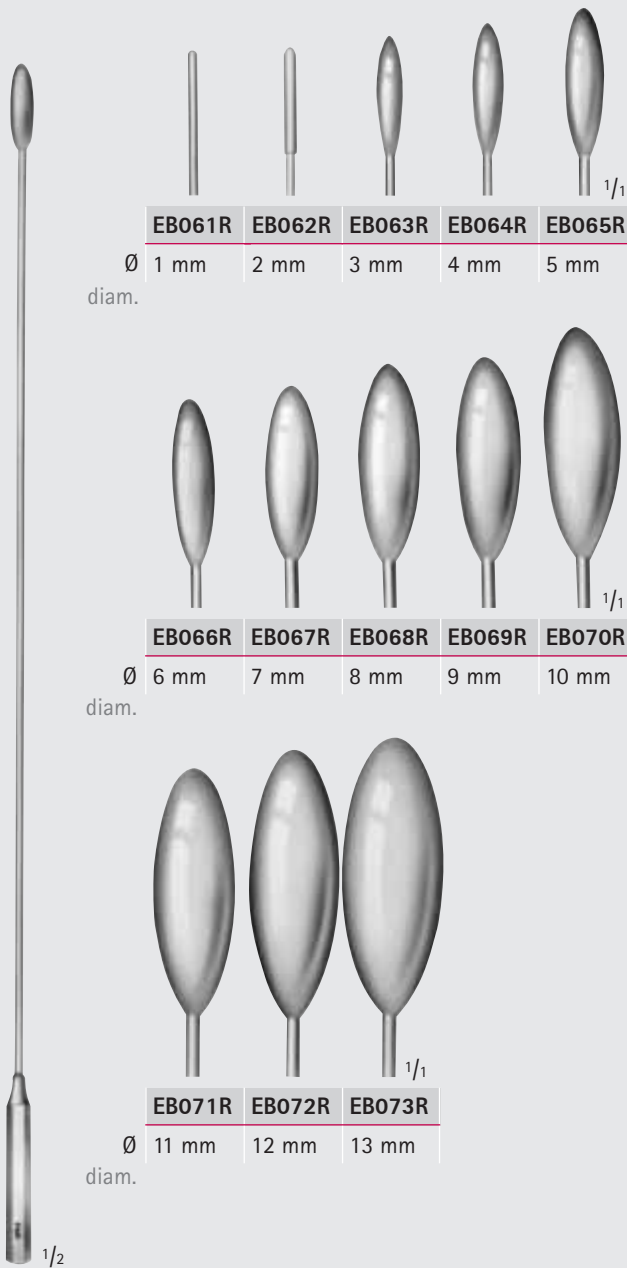
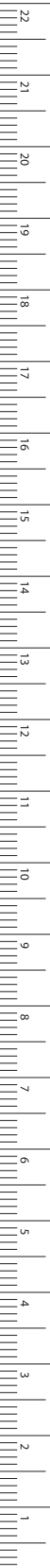

	EB061R	EB062R	EB063R	EB064R	EB065R
Ø diam.	1 mm	2 mm	3 mm	4 mm	5 mm

	EB066R	EB067R	EB068R	EB069R	EB070R
Ø diam.	6 mm	7 mm	8 mm	9 mm	10 mm

	EB071R	EB072R	EB073R
Ø diam.	11 mm	12 mm	13 mm

BAKES

EB061R-EB073R

Gallengangdilations Oliven,
biegsam

Common bile duct dilators,
malleable

EB061R-EB065R 315 mm, 12 1/2"

EB066R-EB073R 320 mm, 12 3/4"

EB074R

Satz à 9 Stück EB063R - EB071R,
in Leinentasche

Set of 9 pieces EB063R - EB071R,
in canvas roll

EB075

Leinentasche allein
Canvas roll only

Instrumente für Galle, Leber – Gall Bladder-, Liver-Instruments

Gallensteinlöffel

Gall Stone Scoops

geeignete Wundhaken siehe Rubrik BT
 selbsthaltende Bauchdeckenrahmen siehe Rubrik BV
 suitable retractors see section BT
 Self-retaining abdominal retractors see section BV

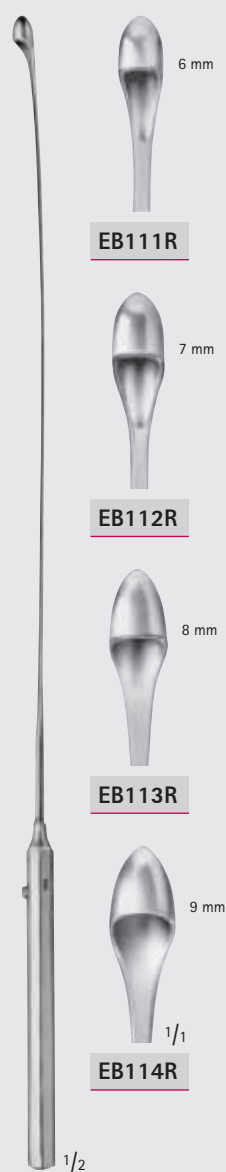

EB111R

EB112R

EB113R

EB114R

DESJARDINS

EB111R-EB114R

Sonde und Fänger mit
 federndem Schaft
 Probe and catch with
 flexible shaft
 300 mm, 12"

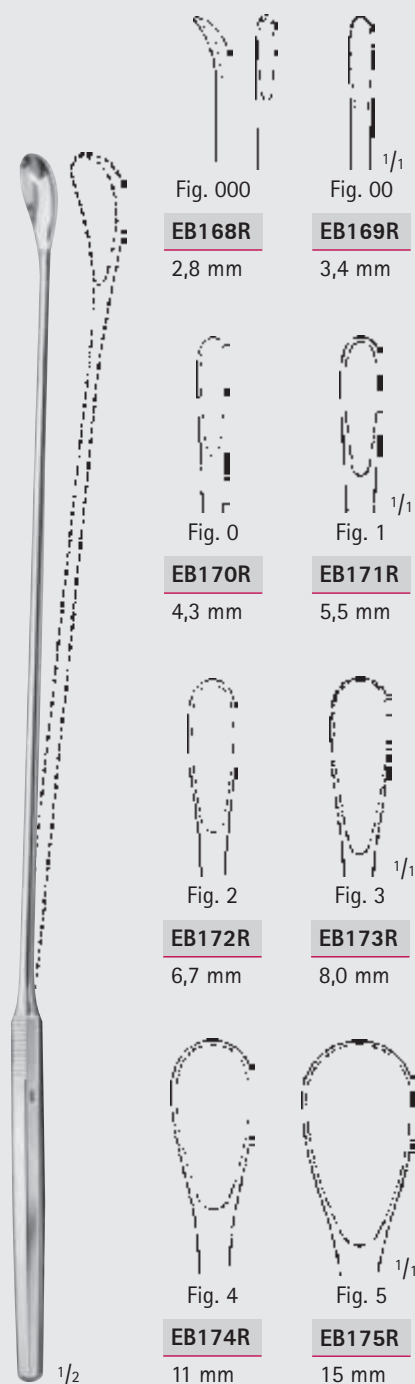

EB168R

EB169R

EB170R

EB171R

EB172R

EB173R

EB174R

EB175R

LUER-KÖRTE MODIF.

EB168R-EB175R

mit biegsamen Schaft
 with malleable shaft
 325 mm, 12 3/4"



Instrumente für Galle, Leber – Gall Bladder-, Liver-Instruments

Gallensteinzangen
Gall Stone Forceps

weitere Gallensteinzangen siehe Rubrik EF
further gall stone forceps see section EF

EB



BLAKE

EB220R

205 mm, 8"

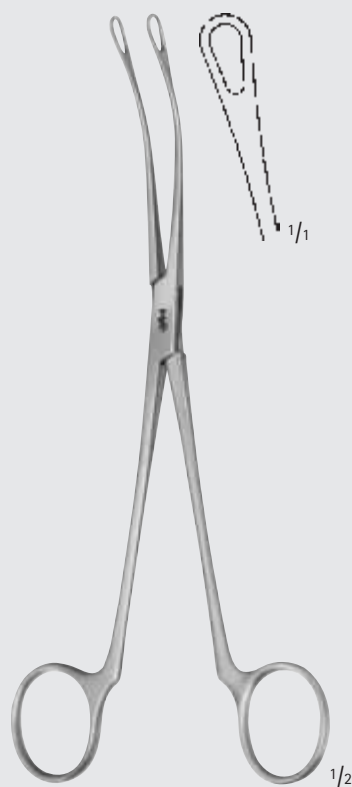

BLAKE

EB221R

205 mm, 8"

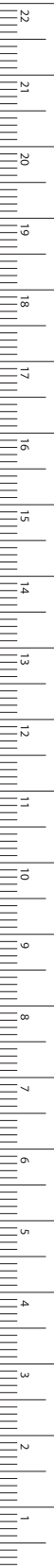

MILLIMETERS

Instrumente für Galle, Leber – Gall Bladder-, Liver-Instruments

Gallensteinzangen

Gall Stone Forceps

EB

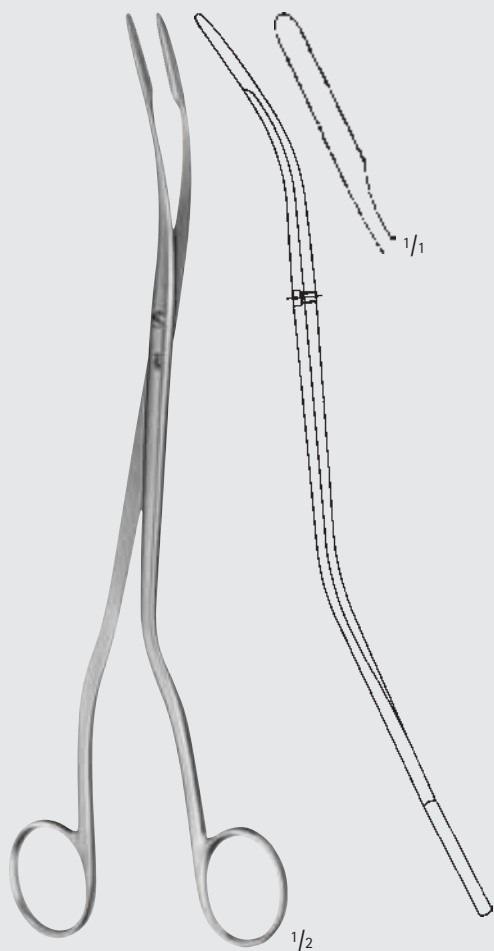

CZERNY

EB225R

245 mm, 9 3/4"



PELKMANN

EO061R

260 mm, 10 1/4"

Instrumente für Galle, Leber – Gall Bladder-, Liver-Instruments

Gallensteinzangen
Gall Stone Forceps

EB



EB231R

EB232R



EB233R

EB234R

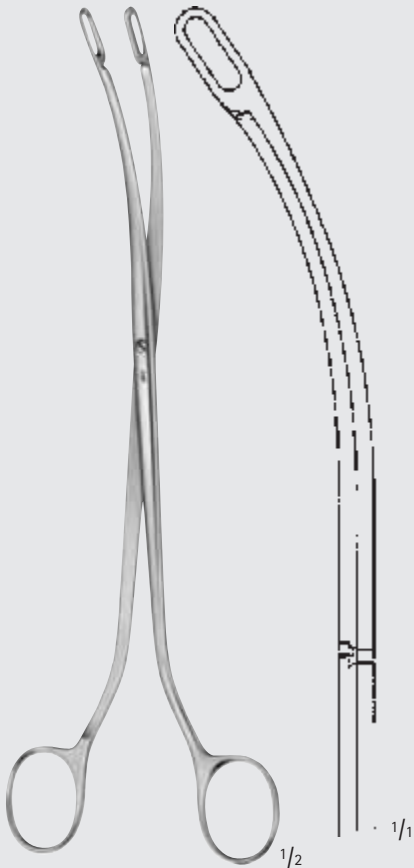

DESJARDINS

EB231R-EB233R

225 mm, 9"



EB240R

240 mm

9 1/2"



DESJARDINS

EB240R-EB242R

besonders schmale Modelle
extremely delicate patterns

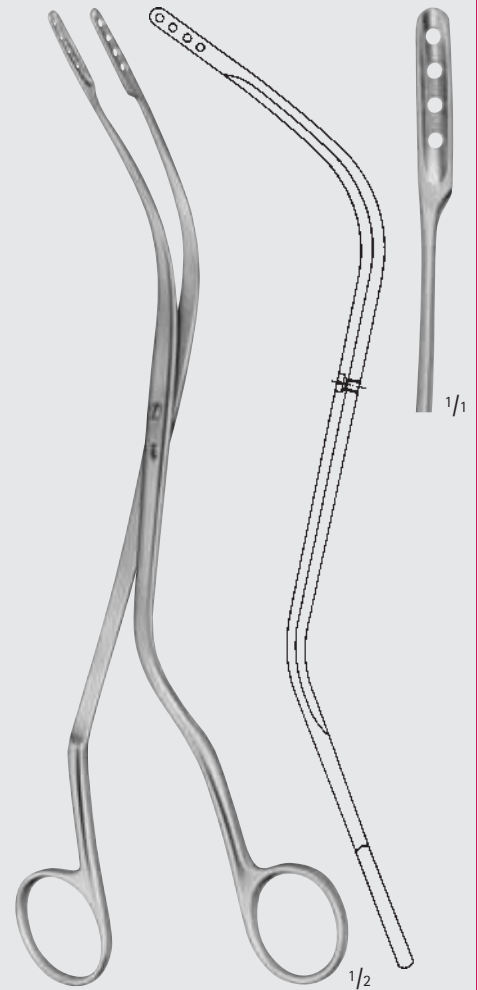

TÜBINGER MODELL

EB239R

255 mm, 10"





INCHES



EF



Urologie-Instrumente
Genito-Urinary Instruments

Urologie-Instrumente – Genito-Urinary Instruments

Nierenklemmen

Kidney Clamps

EF



AIRAUMATA®



EF001R
240 mm
9 1/2"



EF002R
230 mm
9"



EF003R
230 mm
9"

GUYON

EF001R-EF003R



GUYON

EF011R

230 mm, 9"



Urologie-Instrumente – Genito-Urinary Instruments

Nierenklemmen

Kidney Clamps

EF

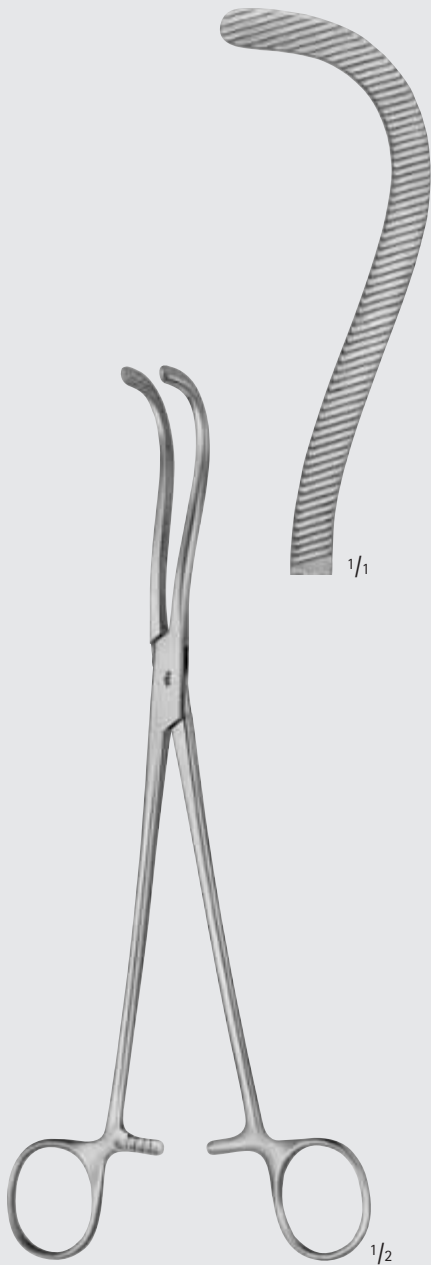

GUYON

EF010R

235 mm, 9 1/4"

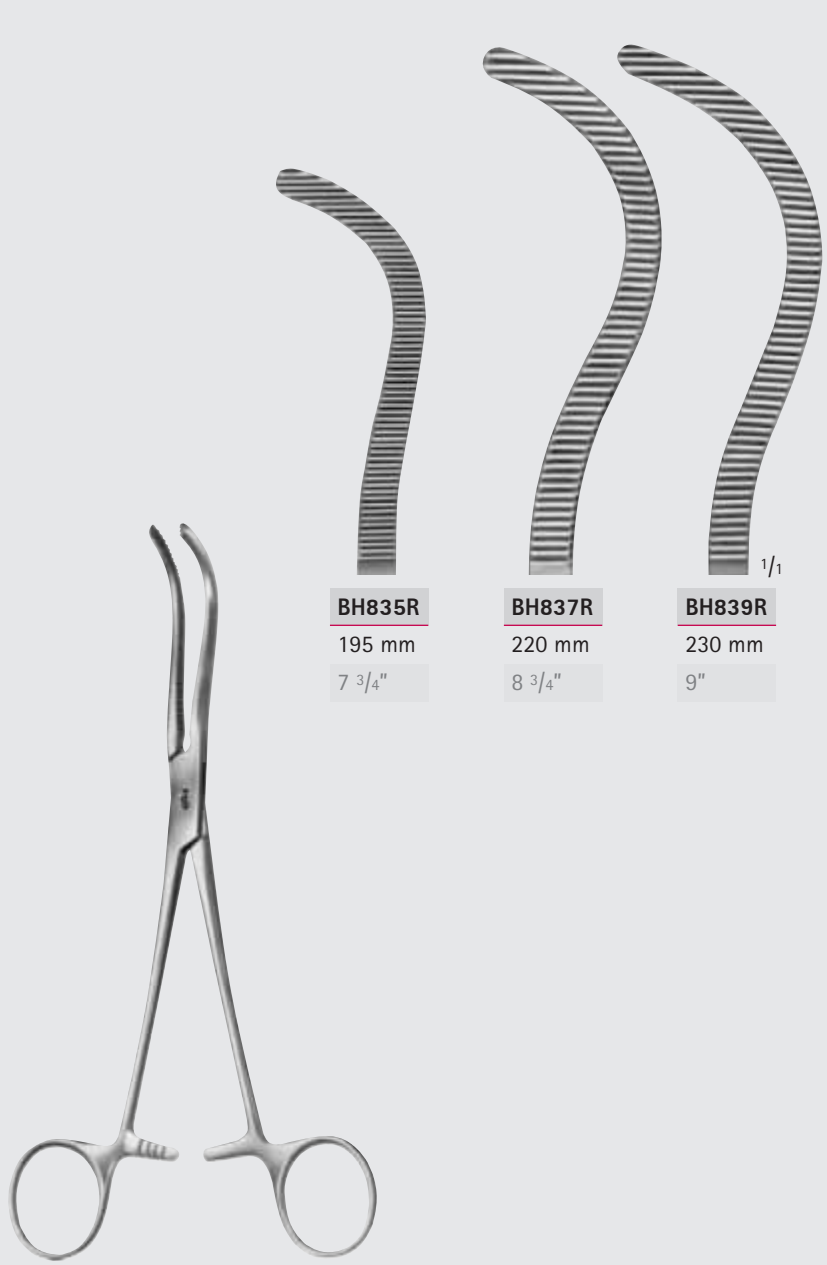

BH835R

195 mm

7 3/4"

BH837R

220 mm

8 3/4"

BH839R

230 mm

9"

PEAN

BH835R-BH839R



MILLIMETERS

Urologie-Instrumente – Genito-Urinary Instruments

Nierenklemmen

Kidney Clamps

EF

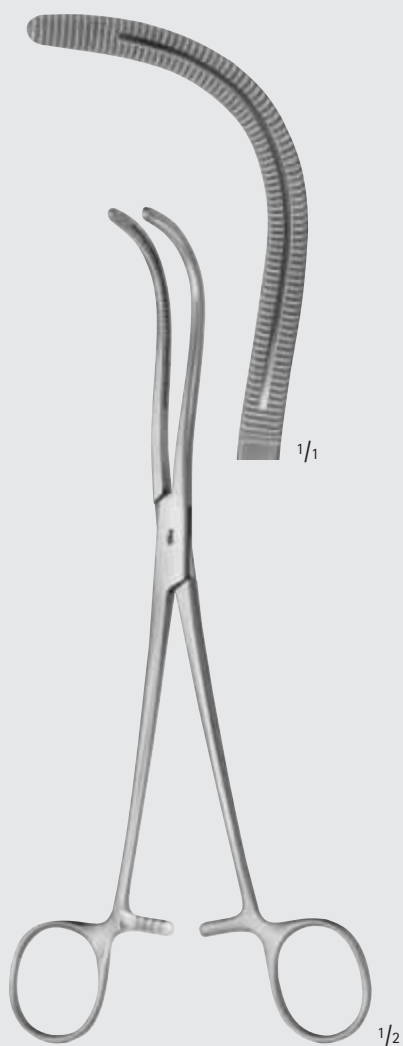

STILLE

EF016R

220 mm, 8 3/4"



STILLE

EF015R

240 mm, 9 1/2"

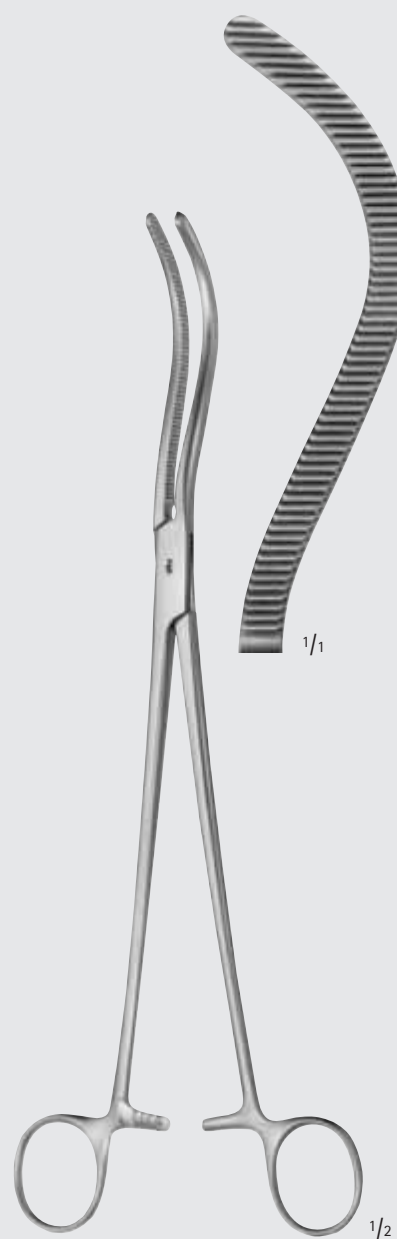

GUYON

EF012R

265 mm, 10 1/2"



Urologie-Instrumente – Genito-Urinary Instruments

Nierenstielklemmen
Kidney Pedicle Clamps

EF



HERRICK

EF030R

225 mm, 9"



WERTHEIM

BJ574R

255 mm, 10"

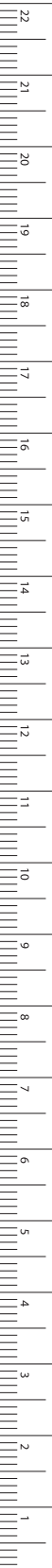

MILLIMETERS

Urologie-Instrumente – Genito-Urinary Instruments

Nierenstielklemmen

Kidney Pedicle Clamps

EF



WERTHEIM-CULLEN

BJ579R

Winkel- und Druckklemme
Angle- and pressure clamp

215 mm, 8 1/2"

AIRAUMATA®



WERTHEIM

BJ581R

Winkel- und Druckklemme
Angle- and pressure clamp

250 mm, 10"



Urologie-Instrumente – Genito-Urinary Instruments

Nierenfasszangen
Kidney Elevating Forceps

EF



COLLIN

EO405R

285 mm, 11 1/4"



DARTIGUES

EO407R

255 mm, 10"

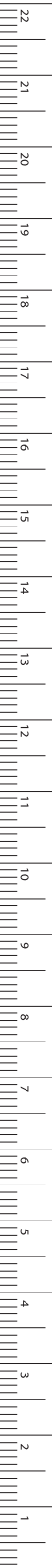

MILLIMETERS

Urologie-Instrumente – Genito-Urinary Instruments

Nierensteinzangen

Kidney Stone Forceps

EF



EF047R

170 mm

6 ³/₄"

EF048R

160 mm

6 ¹/₄"



HEIMING

EF047R-EF048R

für Kinder
for children



EF051R

EF052R

EF053R

EF054R

RANDALL

EF051R-EF054R

225 mm, 9"



Urologie-Instrumente – Genito-Urinary Instruments

Nierensteinzangen
Kidney Stone Forceps

EF



EF055R



EF056R



RANDALL

EF055R-EF056R

190 mm, 7 1/2"



MILLIMETERS

Urologie-Instrumente – Genito-Urinary Instruments

Nierensteinzangen

Kidney Stone Forceps

EF



EB244R

245 mm

9 3/4"



EB246R

230 mm

9"



RANDALL

EB244R-EB246R

besonders schmale Modelle
extremely delicate patterns



Urologie-Instrumente – Genito-Urinary Instruments

Blasenwundspreizer

Bladder Retractors



KUGELSCHNELLVERSCHLUSS

BALL SNAP CLOSURE

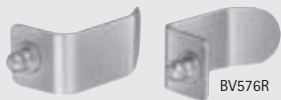

BV576R



BV577R

MILLIN

BV580R

Blasenwundspreizer komplett,
bestehend aus:

- BV575R Sperrer allein
- BV576R Blätter 57 x 25 mm
- BV577R Blätter 82 x 25 mm
- BV578R Mittelblatt 105 x 45 mm

Bladder retractor complete,
consisting of:

- BV575R Spreader only
- BV576R Blades 57 x 25 mm
- BV577R Blades 82 x 25 mm
- BV578R Center blade 105 x 45 mm

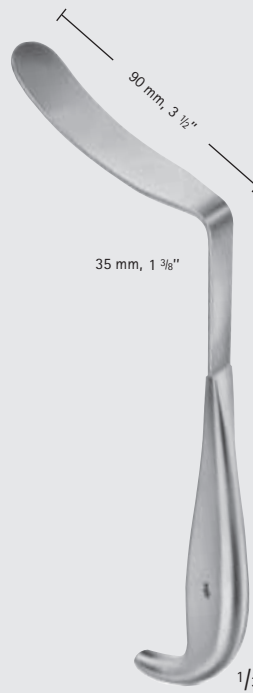

1/3

LEGUEU

BV928R

Blasenspatel

Bladder spatula

260 mm, 10 1/4"

EF

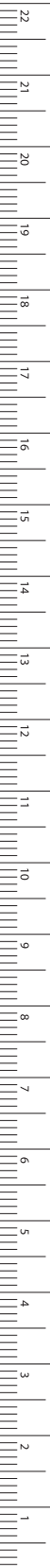

MILLIMETERS

Urologie-Instrumente – Genito-Urinary Instruments

Urologie – Prostatektomie

Genito-Urinary Instruments – Prostatectomy

EF



BARRÉ

BB176R-BB178R

No. 3 XL
für linke Hand
for left hand
250 mm, 10"



BB176R

12°



BB178R

25°

1/1



BARRÉ

BB177R

No. 3 XL
für linke Hand
for left hand
250 mm, 10"

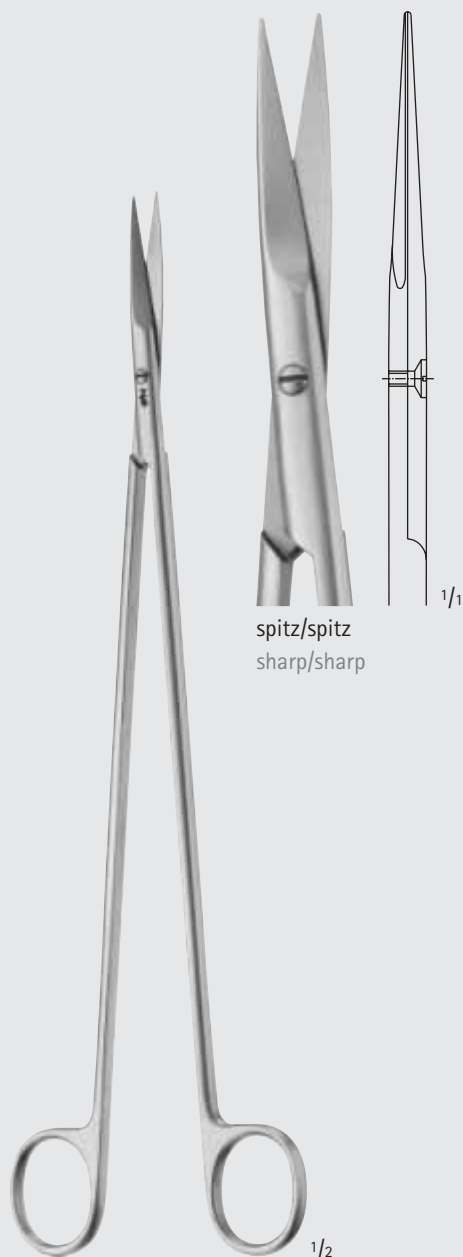

BARRÉ

BC715R

Präparierschere
Dissecting scissors
280 mm, 11"



spitz/spitz
sharp/sharp



1/1

1/2



Urologie-Instrumente – Genito-Urinary Instruments

Urologie - Prostatektomie

Genito-Urinary Instruments - Prostatectomy

EF

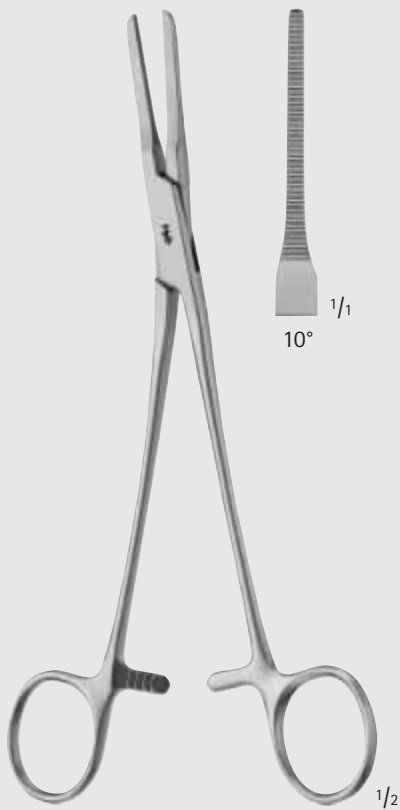

EF167R

Venenklamme
Venous plexus clamp
210 mm, 8 1/4"



BJ029R

extra fein
extra delicate

BJ110R

fein
delicate

BARRE

BJ029R-BJ110R

Präparierklemmen
Dissecting forceps
280 mm, 11"



MILLIMETERS

Urologie-Instrumente – Genito-Urinary Instruments

Urologie - Prostatektomie

Genito-Urinary Instruments - Prostatectomy

EF



BARRÉ

BT680R

Prostata-Retraktor
Prostate retractor

360 mm, 14 3/8"



BARRÉ

BT681R

Urethra-Retraktor
Urethral retractor

390 mm, 15 1/2"



BARRÉ

GK685R

Bipolare Pinzette
Bipolar forceps

260 mm, 10 1/4"



Urologie-Instrumente – Genito-Urinary Instruments

Urologie - Prostatektomie

Genito-Urinary Instruments - Prostatectomy

EF

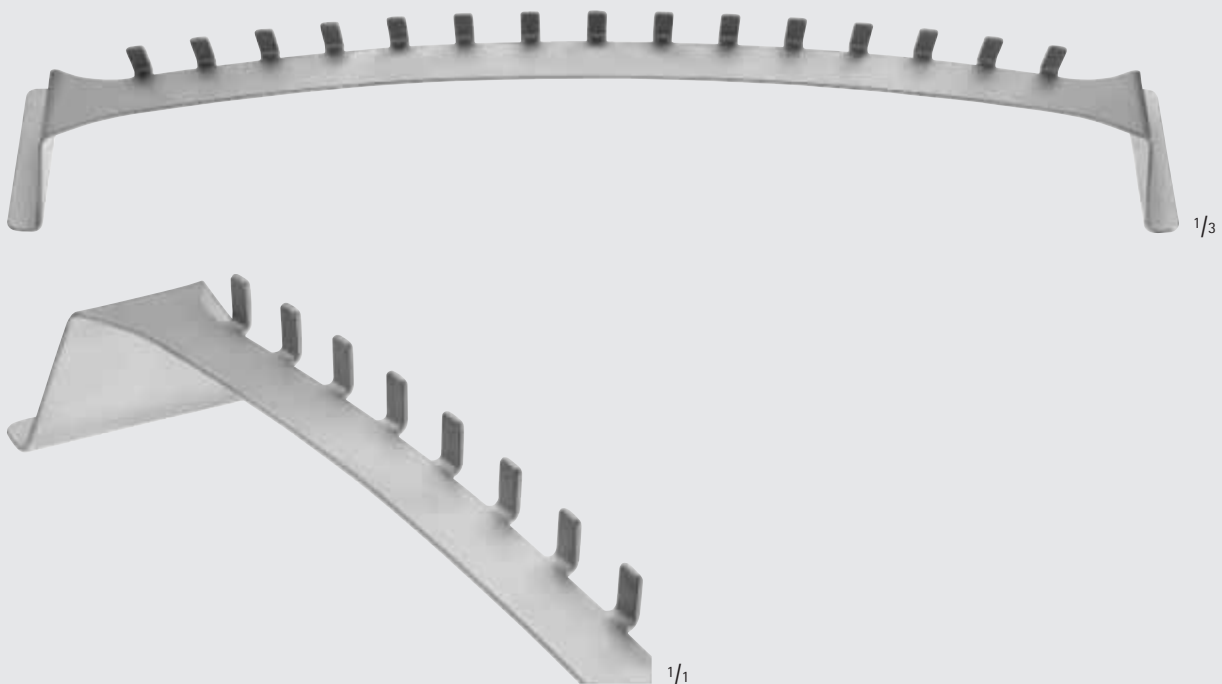

BARRÉ

BV927R

Fadenhaltebügel

Suture holding frame

465 mm, 18 1/3"

MILLIMETERS

Urologie-Instrumente – Genito-Urinary Instruments

Urologie – Prostatektomie

Genito-Urinary Instruments – Prostatectomy

EF

AIRAUMATA®

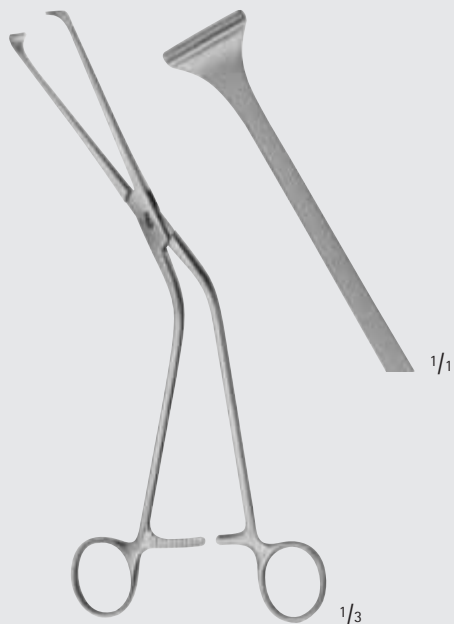

MILLIN

EF163R

Kapselzange

Lobe grasping forceps

245 mm, 9 3/4"

AIRAUMATA®



MILLIN

EF164R

Kapselzange

Lobe grasping forceps

235 mm, 9 1/4"



MILLIN

EF168R

Fadenzange

Ligature holding forceps

245 mm, 9 3/4"

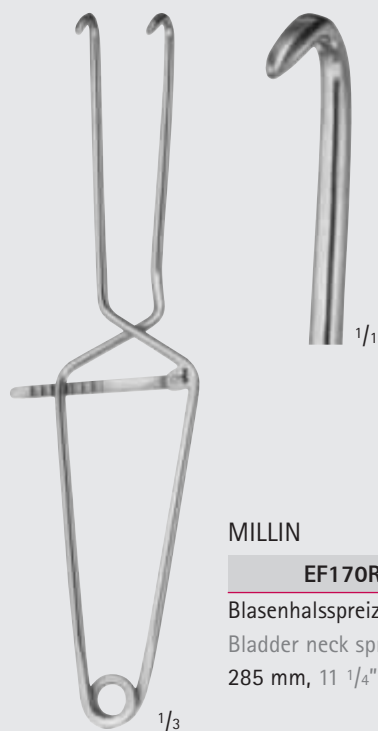

MILLIN

EF170R

Blasenhalsspreizer

Bladder neck spreader

285 mm, 11 1/4"

INCHES



Urologie-Instrumente – Genito-Urinary Instruments

Urologie - Prostatektomie

Genito-Urinary Instruments - Prostatectomy

EF



BM627R



BM628R



BM629R

BM627R-BM629R

Ersatz-Nadeln
Spare needles



YOUNG-HRYNTSCHAK

BM620R

Bumerang-Nadelhalter
mit 1 Nadel BM627R
Boomerang Needle Holder
with 1 needle BM627R
240 mm, 9 1/2"

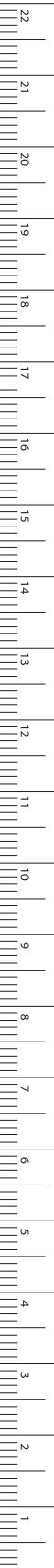

MILLIMETERS

Urologie-Instrumente – Genito-Urinary Instruments

Urologie-Instrumente

Genito-Urinary Instruments

EF



AIRAUMATA®



EF070R

Ureterzange

Ureter Forceps

240 mm, 9 1/2"

Urologie-Instrumente – Genito-Urinary Instruments

Urologie-Instrumente
Genito-Urinary Instruments

EF

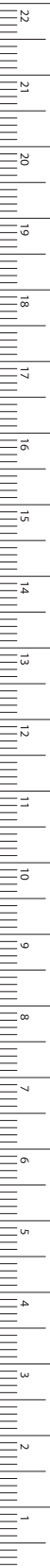

MILLIMETERS



STOCKMANN

EF400R

Penisklemme

Penis clamp

70 mm, 2 3/4"



STRAUSS

EF401R

Penisklemme

Penis clamp

130 mm, 5 1/8"



EF155R

Zange zum Erfassen der
Glans und der Vorhaut,
Ring-Ø 4,8 mm

Forceps for grasping the
glans and the foreskin,
ring diam. 4.8 mm

125 mm, 5"



EF195R

Klemme zum Fixieren
des Samenstrangs

Fixation clamp for the
spermatic cord

145 mm, 5 3/4"

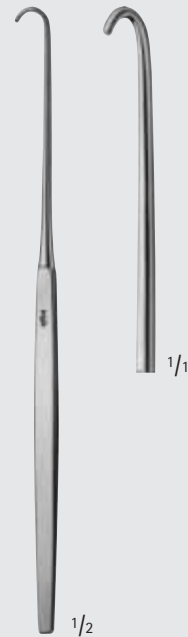

BT126R

Haken für den Samenstrang
Hook for the spermatic cord

165 mm, 6 1/2"

Urologie-Instrumente – Genito-Urinary Instruments

Urologie-Harnröhre

Genito-Urinary Instruments

EF

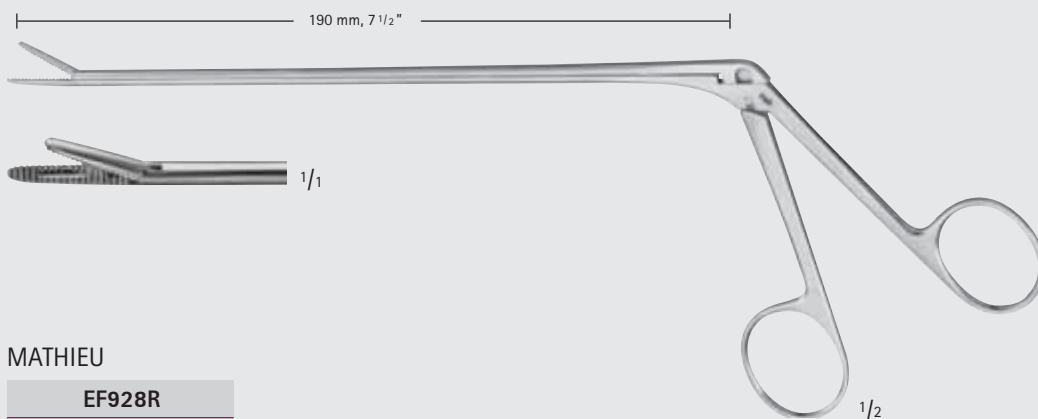

MATHIEU

EF928R

Fremdkörperzange

Foreign body forceps

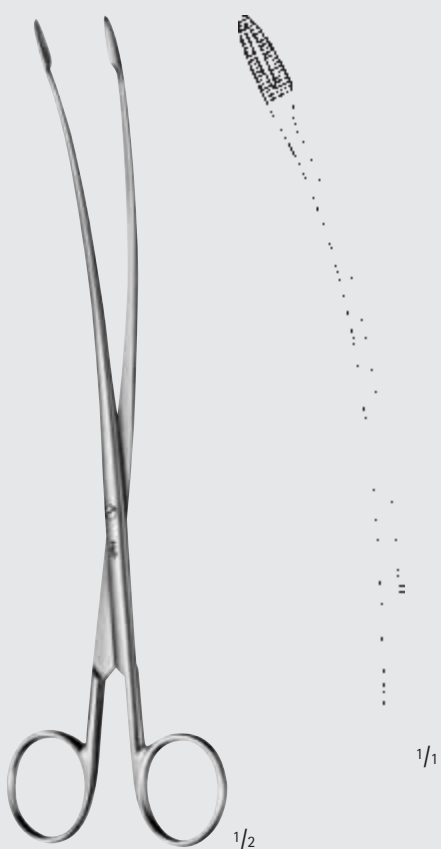

PITHA

EF921R

Fremdkörperzange

Foreign body forceps

220 mm, 8 3/4"

biegsam
malleable

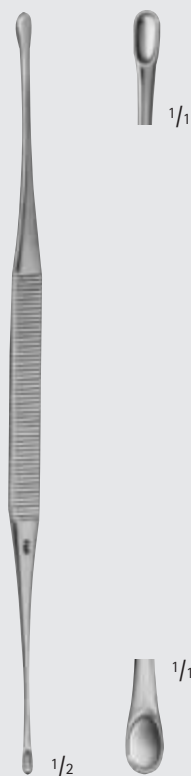

ASCH

ER005R

Sekretlöffel, stumpf

Secretion scoop, blunt

200 mm, 8"



Urologie-Instrumente – Genito-Urinary Instruments

Urologie-Instrumente
Genito-Urinary Instruments

EF

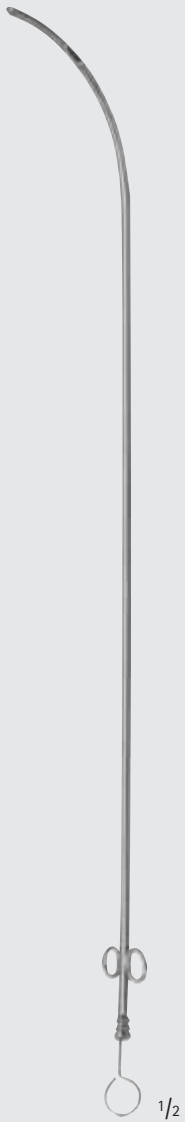

Charr. (French)

EF208C	8
EF210C	10
EF212C	12
EF214C	14
EF216C	16
EF218C	18
EF220C	20

Metallkatheter
für Männer
Male catheters,
metal
290 mm, 11 1/2"



Charr. (French)

EF306C	6
EF308C	8
EF310C	10
EF312C	12
EF314C	14
EF316C	16
EF318C	18

Metallkatheter
für Frauen
Female catheters
metal
155 mm, 6"

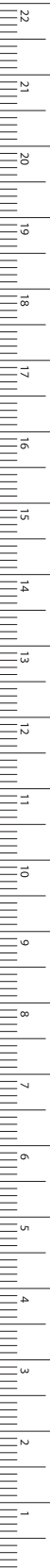

MILLIMETERS

Urologie-Instrumente – Genito-Urinary Instruments

Urologie-Instrumente

Genito-Urinary Instruments

EF

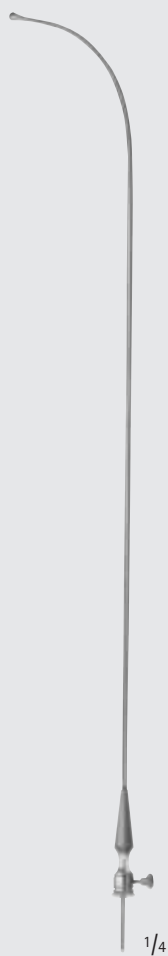

EF491C

Katheterspanner und
Einführungsinstrument
Catheter guide
(introducer)
490 mm, 19 1/2"



GUYON

EF492R

Katheterspanner und
Einführungsinstrument
Catheter guide
(introducer)
365 mm, 14 1/2"



EF493R

Kathetereinführungsinstrument
Introducer for catheters
460 mm, 18"



Urologie-Instrumente – Genito-Urinary Instruments

Urologie-Instrumente
Genito-Urinary Instruments

EF



1/2

Charr. (French)

EF638R	8
EF639R	9
EF640R	10
EF641R	11
EF642R	12
EF643R	13
EF644R	14
EF645R	15
EF646R	16
EF647R	17
EF648R	18
EF649R	19
EF650R	20
EF651R	21
EF652R	22
EF653R	23
EF654R	24
EF655R	25
EF656R	26
EF657R	27
EF658R	28
EF659R	29
EF660R	30

DITTEL

EF638R-EF660R

Metallbougie-Öffner, starr
Urethral bougies
and dilating sounds, stiff
345 mm, 13 3/4"



1/2

TURNER WARWICK

EF790R

Harnröhrenbougie
Retrograde bougie
180 mm, 7"

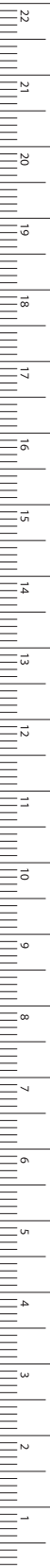

MILLIMETERS

Urologie-Instrumente – Genito-Urinary Instruments

Urologie-Instrumente

Genito-Urinary Instruments

EF



EF824R	Ben.24/Charr.12
EF826R	Ben.26/Charr.13
EF828R	Ben.28/Charr.14
EF830R	Ben.30/Charr.15
EF832R	Ben.32/Charr.16
EF834R	Ben.34/Charr.17
EF836R	Ben.36/Charr.18
EF838R	Ben.38/Charr.19
EF840R	Ben.40/Charr.20
EF842R	Ben.42/Charr.21
EF844R	Ben.44/Charr.22
EF846R	Ben.46/Charr.23
EF848R	Ben.48/Charr.24
EF850R	Ben.50/Charr.25
EF852R	Ben.52/Charr.26
EF854R	Ben.54/Charr.27
EF856R	Ben.56/Charr.28
EF858R	Ben.58/Charr.29
EF860R	Ben.60/Charr.30

GUYON

EF824R-EF860R

Metallbougie-Öffner

Urethral bougies and
dilating sounds

255 mm, 10"

Urologie-Instrumente – Genito-Urinary Instruments

Beschneidungsklemmen Circumcision Clamps

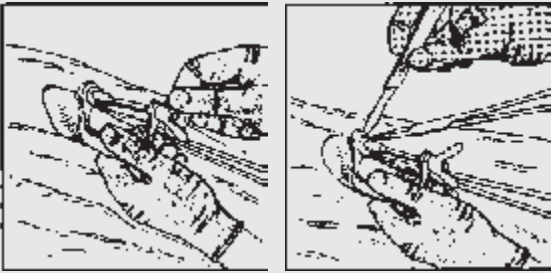

⌘ Der glockenförmige Stempel der Beschneidungsklemme wird über die Eichel geschoben und die Vorhaut darübergezogen, was 2 Klemmen oder Haltefäden erleichtern.

⌘ Die Flügelmutter wird so stark wie möglich angezogen, so dass die Vorhaut ringförmig maximal komprimiert wird.

⌘ Mit dem Skalpell wird die Vorhaut unmittelbar am Kompressionsring abgetragen. Zur Vermeidung von Blutungen bleibt die Beschneidungsklemme einige Minuten liegen. Es empfiehlt sich, größere Venen, in jedem Falle aber die Frenulararterie nach etwaiger Durchtrennung zu unterbinden.

⌘ Der Vorteil dieser Beschneidungsart liegt in der kosmetisch günstigen Narbe, wie sie nach Abstoßung des dünnen Nekrosesaumes entsteht.

⌘ Assisted by two hemostats or ligatures the foreskin is pushed over the bellshaped protection-rod and the glans is placed into it.

⌘ By now, the wing-nut is tightened as close as possible, so the foreskin is annular compressed. The foreskin is cut off with a scalpel, right next to the compression ring.

⌘ The circumcision clamp remains a few minutes to avoid bleeding. In case that any large vein, specially the frenular artery, is cut through, a ligature must be set.

⌘ The advantage of the method described is the cosmeticly favourable scar which is left after rejection of the small necrotized portion.

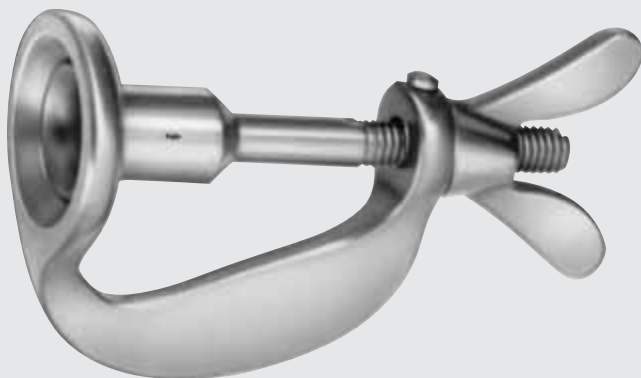

WINKELMANN

∅

diam.

EF965R 12 mm

EF966R 16 mm

EF967R 20 mm

Beschneidungsklemmen

Circumcision clamps

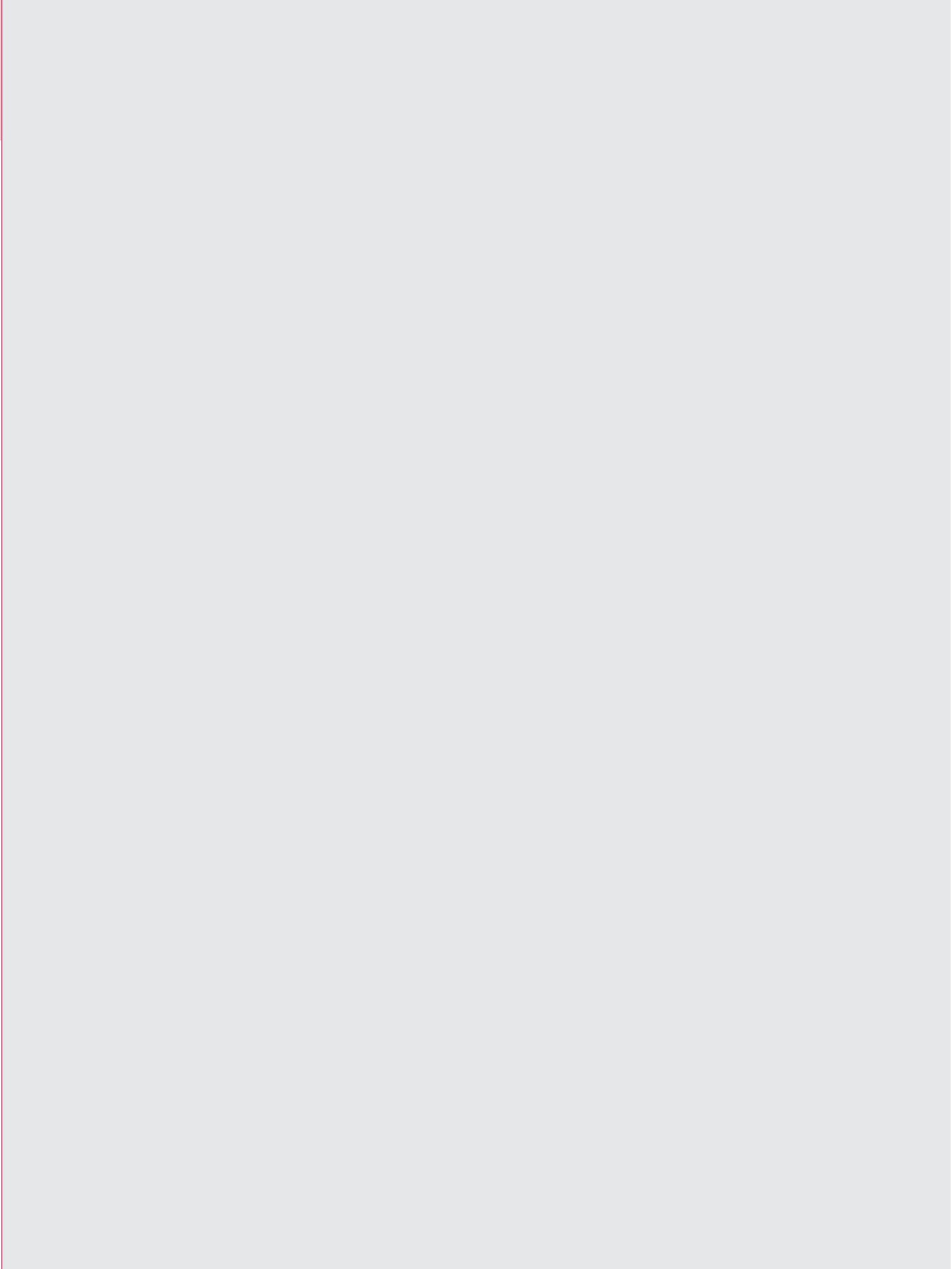

EJ



Trokare
Trocars

Trokare – Trocars

Trokare

Trochars

EJ

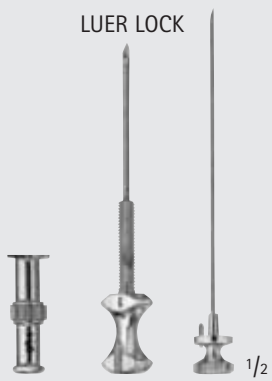

KLIMA-ROSEGGER

SR428R

Sternal-Punktionskanüle

Sternal puncture needle

1,8 x 35 mm

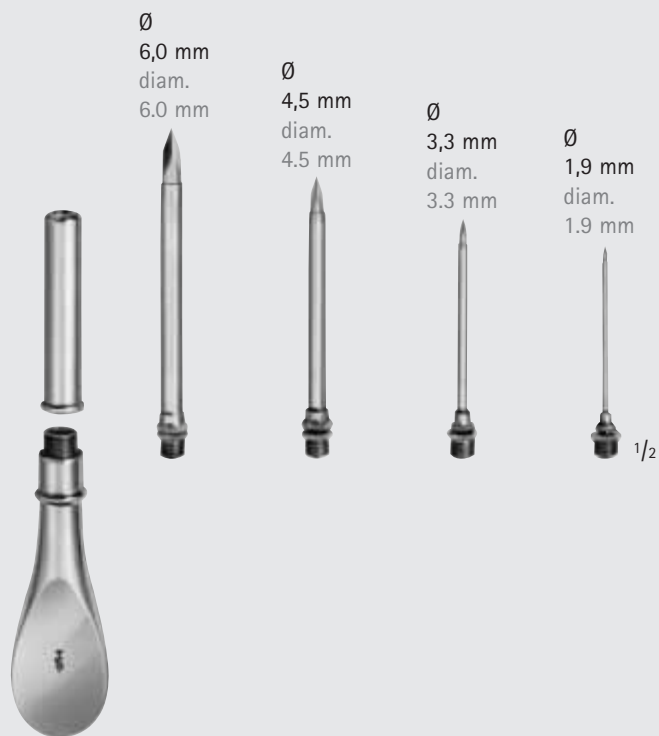

EJ126R

Universaltrokar mit 4
Aufsätzen

Universal trocar with 4 tips



EL



Scheidenspekula
Vaginal Specula

Scheidenspekula – Vaginal Specula

Scheidenspekula
Vaginal Specula

Scheidenspekula
Schema für Maßangaben bei Spekula
Vaginal specula
How to measure vaginal specula

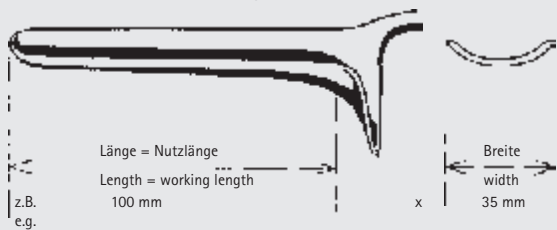

COLLIN

ELO10C

53 x 10 mm
für Kinder
for children

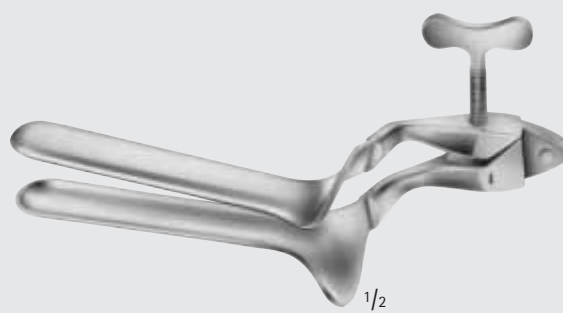

COLLIN

ELO11R

95/85 x 18 mm
für Jungfrauen
for virgins

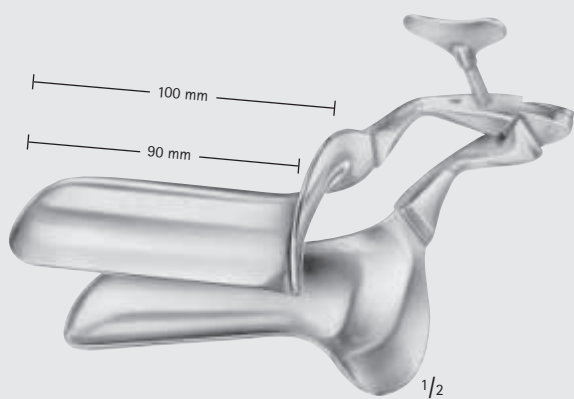

COLLIN

Gesamtlänge/Nutzlänge
Total length/working length

Breite
Width

ELO13R	100/90 mm	28 mm
ELO14R	100/90 mm	32 mm
ELO15R	105/95 mm	35 mm
ELO16R	115/105 mm	40 mm



Scheidenspekula – Vaginal Specula

Scheidenspekula
Vaginal Specula

73



CUSCO

ELO40R

75 x 17 mm
für Jungfrauen
for virgins

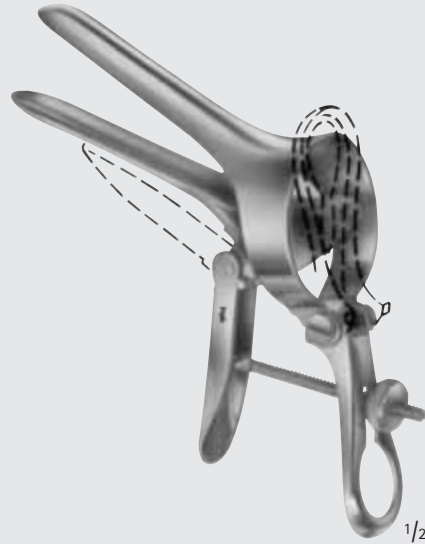

CUSCO

EL075R

75 x 17 mm
für Jungfrauen
for virgins

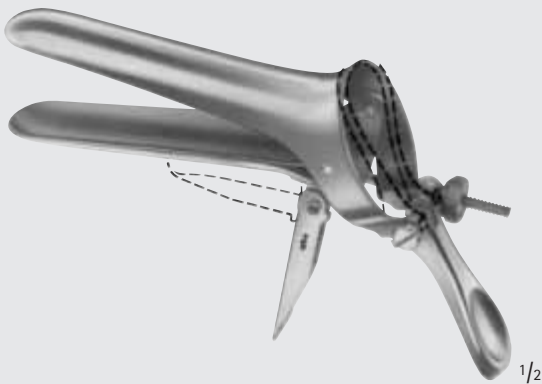

CUSCO

EL056R	92 x 23 - 25 mm
EL057R	100 x 25 - 27 mm
EL058R	110 x 27 - 30 mm

Schweizer Modelle
speziell: lang und schmal
Swiss patterns
features: long and narrow

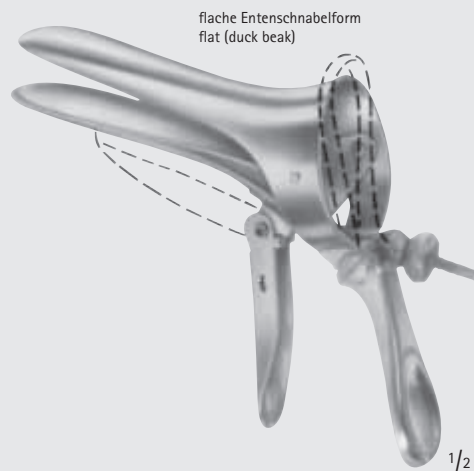

CUSCO

EL086R	80 x 32 mm
EL087R	90 x 37 mm
EL088R	115 x 37 mm



Scheidenspekula – Vaginal Specula

Scheidenspekula

Vaginal Specula

Scheidenspekula

Schema für Maßangaben bei Spekula

Vaginal specula

How to measure vaginal specula

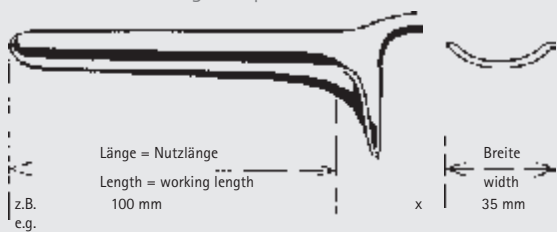

CUSCO STANDARD

EL041R	80 x 24 mm
EL042R	80 x 32 mm
EL043R	90 x 36 mm
EL044R	110 x 37 mm

Standard-Modelle
Standard patterns

CUSCO

EL076R	80 x 24 mm
EL077R	80 x 32 mm
EL078R	90 x 36 mm
EL079R	110 x 37 mm

CUSCO

EL080R	107 x 29 mm
EL081R	115 x 35 mm

mit Absaugrohr
with suction tube

TRELAT

EL150R	85 x 33 mm
EL151R	95 x 35 mm
EL152R	115 x 43 mm



Scheidenspekula – Vaginal Specula

Scheidenspekula
Vaginal Specula

73

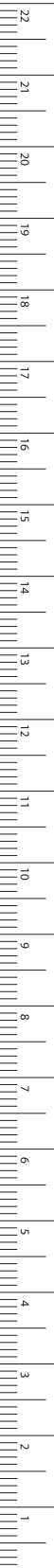

MILLIMETERS

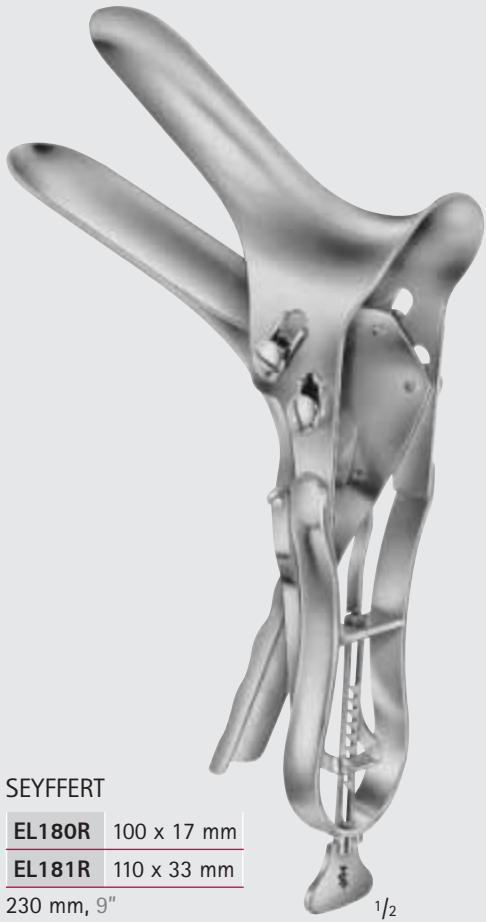

SEYFFERT

EL180R 100 x 17 mm

EL181R 110 x 33 mm

230 mm, 9"

1/2

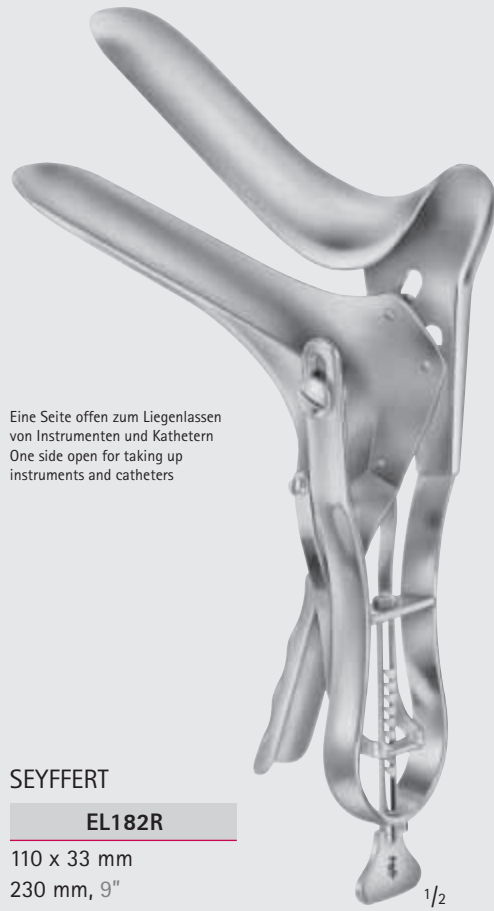

Eine Seite offen zum Liegenlassen
von Instrumenten und Kathetern
One side open for taking up
instruments and catheters

SEYFFERT

EL182R

110 x 33 mm

230 mm, 9"

1/2



Mit Doppelsperre, Fixieren und Lösen
der Sperre durch Daumendruck
With double ratchet, closing and
opening of ratchet by pressure of thumb

SEMM

EL183R

90 x 14 - 18 mm

für Kinder und Jungfrauen
for children and virgins

180 mm, 7"

1/2



Mit Doppelsperre, Fixieren und Lösen
der Sperre durch Daumendruck
With double ratchet, closing and
opening of ratchet by pressure of thumb

SEMM

EL184R 100 x 20 - 24 mm

EL185R 100 x 30 - 34 mm

185 mm, 7 1/4"

1/2

Scheidenspekula – Vaginal Specula

Scheidenspekula
Vaginal Specula

Scheidenspekula
Schema für Maßangaben bei Spekula
Vaginal specula
How to measure vaginal specula

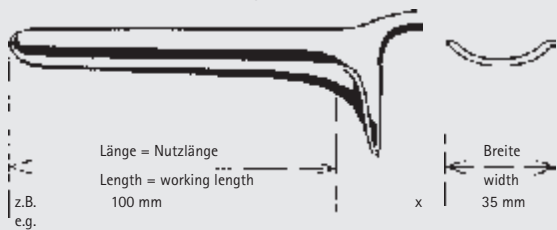

	Nutzlänge x Breite Working length x Width	Gesamtlänge Total length
SIMS		
EL407R	70 x 26 / 75 x 30 mm	125 mm, 5"
EL408R	75 x 30 / 80 x 35 mm	150 mm, 6"
EL409R	80 x 36 / 90 x 40 mm	175 mm, 7"

EL





Scheidenspekula – Vaginal Specula

Scheidenspekula - Sätze, obere und untere Blätter

Vaginal Specula - Sets, Upper and Lower Blades

73

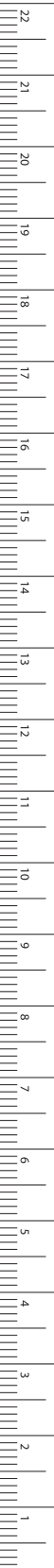

MILLIMETERS



SEIDEL

EL410R	80 x 8 mm
EL411R	80 x 10 mm
EL413R	90 x 14 mm

für Kinder und Kleinkinder
for children and infants
170 mm, 6 3/4"

1/2



KRISTELLER

EL420R

70 x 15 mm
für Kinder
for children
170 mm, 6 3/4"

1/2



KRISTELLER

EL421R	70 x 27 mm
EL422R	75 x 30 mm
EL423R	90 x 36 mm

175 mm, 7"

1/2



KRISTELLER

EL424R	110 x 18 mm
EL426R	110 x 20 mm
EL425R	110 x 27 mm
EL427R	110 x 30 mm
EL428R	110 x 36 mm

220 mm, 8 3/4"

1/2

Scheidenspekula – Vaginal Specula

Scheidenspekula - untere Blätter

Vaginal Specula - Lower Blades

Scheidenspekula

Schema für Maßangaben bei Spekula

Vaginal specula

How to measure vaginal specula

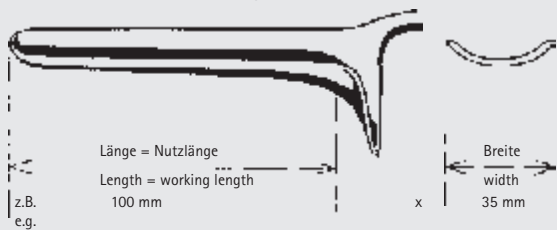

EL440R

70 x 15 mm

175 mm

7"



EL441R

70 x 27 mm

180 mm

7"



EL442R

75 x 30 mm

180 mm

7"



EL443R

90 x 36 mm

185 mm

7 1/4"

KRISTELLER

EL440R-EL443R

untere Blätter

lower blades

EL





Scheidenspekula – Vaginal Specula

Scheidenspekula – obere Blätter

Vaginal Specula - Upper Blades

13

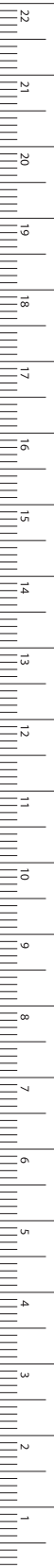

MILLIMETERS



KRISTELLER

EL450R-EL453R

obere Blätter
upper blades



EL450R

75 x 10 mm

175 mm

7"



EL451R

75 x 23 mm

180 mm

7"



EL452R

80 x 25 mm

180 mm

7"



EL453R

100 x 32 mm

185 mm

7 1/4"

Scheidenspekula – Vaginal Specula

Scheidenspekula - untere Blätter

Vaginal Specula - Lower Blades

Scheidenspekula

Schema für Maßangaben bei Spekula

Vaginal specula

How to measure vaginal specula

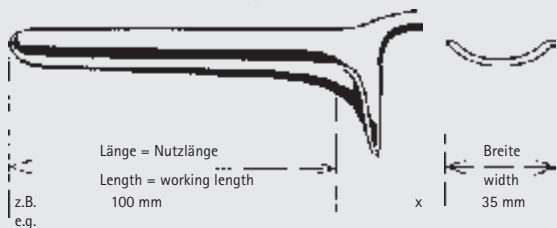

EL444R

110 x 18 mm

215 mm

8 1/2"

EL445R

110 x 27 mm

215 mm

8 1/2"

EL446R

110 x 20 mm

220 mm

8 3/4"

EL447R

110 x 30 mm

220 mm

8 3/4"

EL448R

110 x 36 mm

225 mm

9"

KRISTELLER

EL444R-EL448R

untere Blätter

lower blades

EL





Scheidenspekula – Vaginal Specula

Scheidenspekula – obere Blätter

Vaginal Specula - Upper Blades

73



EL454R

115 x 14 mm

215 mm

8 1/2"

EL455R

115 x 23 mm

215 mm

8 1/2"

EL456R

115 x 16 mm

220 mm

8 3/4"

EL457R

115 x 26 mm

220 mm

8 3/4"

EL458R

120 x 30 mm

225 mm

9"

KRISTELLER

EL454R-EL458R

obere Blätter

upper blades

MILLIMETERS

Scheidenspekula – Vaginal Specula

Scheidenspekula

Vaginal Specula

Scheidenspekula

Schema für Maßangaben bei Spekula

Vaginal specula

How to measure vaginal specula

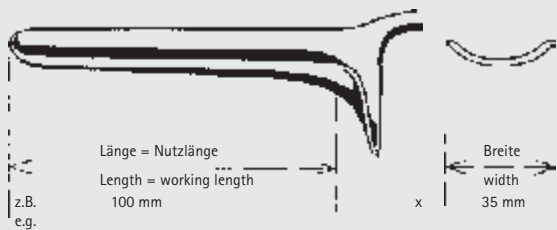

KALLMORGEN

EL480R

75 x 39 mm

Satz

Set

170 mm, 6 ³/₄"



KALLMORGEN

EL481R

95 x 39 mm

Satz

Set

200 mm, 8"

EL





Scheidenspekula – Vaginal Specula

Scheidenspekula
Vaginal Specula

73

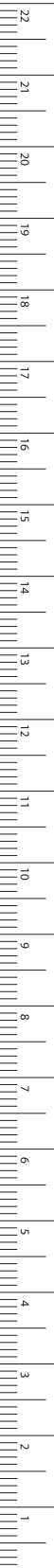

EL494R

110 x 20 mm



EL495R

110 x 30 mm



EL496R

110 x 36 mm



KRISTELLER

EL494R-EL496R

untere Blätter

lower blades

215 mm, 8 1/2"



EL497R

115 x 18 mm



EL498R

115 x 26 mm



KRISTELLER

EL497R-EL499R

obere Blätter

upper blades

220 mm, 8 3/4"

KRISTELLER

EL491R 110 x 20 mm

EL492R 110 x 30 mm

EL493R 110 x 36 mm

Wiener Modelle

Sätze

Vienna patterns

Sets

Scheidenspekula – Vaginal Specula

Scheidenspekula für Kinder und Jungfrauen

Vaginal Specula for Children and Virgins

Scheidenspekula
 Schema für Maßangaben bei Spekula
 Vaginal specula
 How to measure vaginal specula

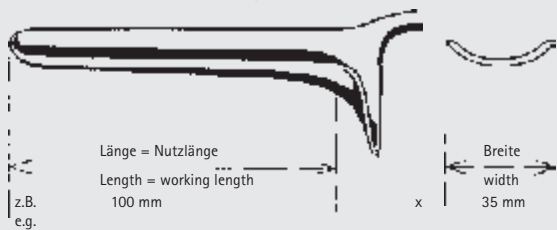

BRAUN

EL550R

56 x 13 mm
 180 mm, 7"



BRAUN

EL551R

60 x 10 mm
 180 mm, 7"

EL





Scheidenspekula – Vaginal Specula

Scheidenspekula für Kinder und Jungfrauen
Vaginal Specula for Children and Virgins

EL



MATHIEU

EL558R

95 x 17 - 30 mm
210 mm, 8 1/4"



MATHIEU

EL559R

95 x 17 - 26 mm
passend zu EL558R
fitting EL558R
210 mm, 8 1/4"

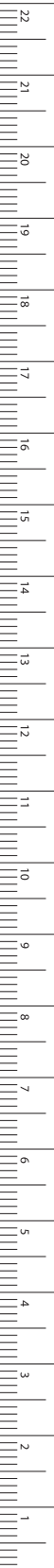

Scheidenspekula – Vaginal Specula

Scheidenspekula

Vaginal Specula

Scheidenspekula

Schema für Maßangaben bei Spekula

Vaginal specula

How to measure vaginal specula

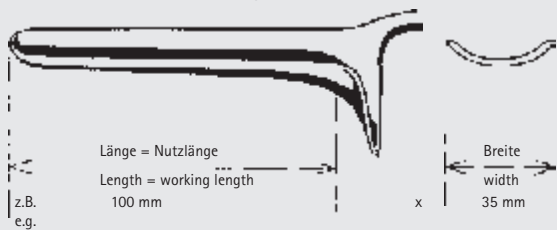

EL578R
89 x 38 mm



EL579R
102 x 38 mm

leicht hohl
slightly concave



JACKSON
EL578R-EL579R
175 mm, 7"



EL627R
60 x 45 mm



EL628R
90 x 45 mm



EL629R
112 x 45 mm



DOYEN
EL627R-EL629R
235 mm, 9 1/4"

EL





Scheidenspekula – Vaginal Specula

Scheidenspekula
Vaginal Specula

73



DOYEN

EL631R-EL644R

240 mm, 9 1/2"

	Länge Length	Breite Width
EL631R	60 mm	35 mm
EL632R	90 mm	35 mm
EL633R	120 mm	35 mm
EL634R	60 mm	45 mm
EL635R	90 mm	45 mm
EL636R	120 mm	45 mm
EL637R	60 mm	60 mm
EL638R	90 mm	60 mm
EL639R	120 mm	60 mm
EL642R	160 mm	45 mm
EL644R	160 mm	60 mm



LANDON

EL660R

89 x 25 mm
195 mm, 7 3/4"



MILLIMETERS

Scheidenspekula – Vaginal Specula

Scheidenspekula

Vaginal Specula

Scheidenspekula

Schema für Maßangaben bei Spekula

Vaginal specula

How to measure vaginal specula

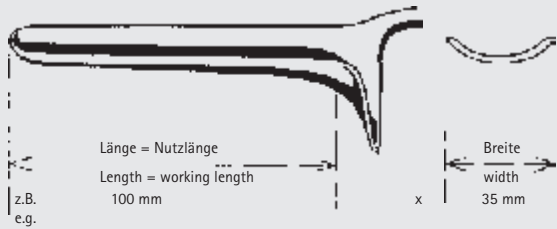

EASTMAN

EL581R

89 x 38 mm
175 mm, 7"



HEANEY

EL865R

83 x 29 mm
170 mm, 6 3/4"

EL





Scheidenspekula – Vaginal Specula
Scheidenspekula
Vaginal Specula

73



LANDAU

EL690R 100 x 28 mm

EL691R 110 x 38 mm

290 mm, 11 1/2"



BREISKY

EL703R 100 x 20 mm

EL704R 100 x 25 mm

EL705R 100 x 30 mm

EL707R 100 x 35 mm

EL708R 100 x 40 mm

Wiener Modelle

Vienna patterns

300 mm, 12"



BREISKY

EL693R 130 x 20 mm

EL694R 130 x 25 mm

EL695R 130 x 30 mm

EL697R 130 x 35 mm

EL698R 130 x 40 mm

Wiener Modelle

Vienna patterns

320 mm, 12 3/4"



BREISKY

EL700R 160 x 40 mm

EL702R 180 x 40 mm

Wiener Modelle

Vienna patterns

350 mm, 14"

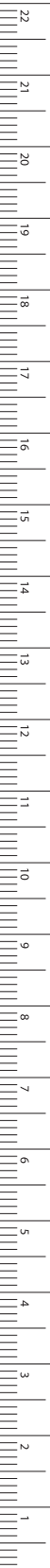

MILLIMETERS

Scheidenspekula – Vaginal Specula

Scheidenhalter und Wundhaken

Vaginal- and Wound Retractors

Scheidenspekula

Schema für Maßangaben bei Spekula

Vaginal specula

How to measure vaginal specula

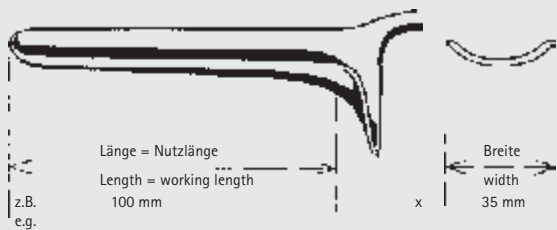

WEISSBARTH

EL720C 80 x 28 mm

EL721C 85 x 42 mm

210 mm, 8 1/4 "

EL722C

abnehmbares Auffangsieb
allein
removable strainer only



DOYEN

EL859R

60 x 30 mm
seitliches Spekulum
lateral speculum

1/2 230 mm, 9"



DOYEN

EL860R

80 x 30 mm
seitliches Spekulum
lateral speculum

1/2 250 mm, 10"

EL





Scheidenspekula – Vaginal Specula

Scheidenhalter und Wundhaken
Vaginal- and Wound Retractors

73

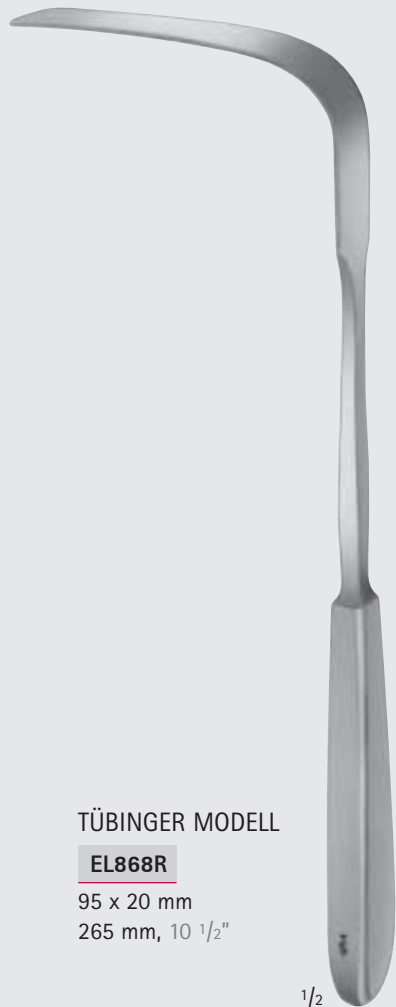

TÜBINGER MODELL

EL868R

95 x 20 mm
265 mm, 10 1/2"

1/2

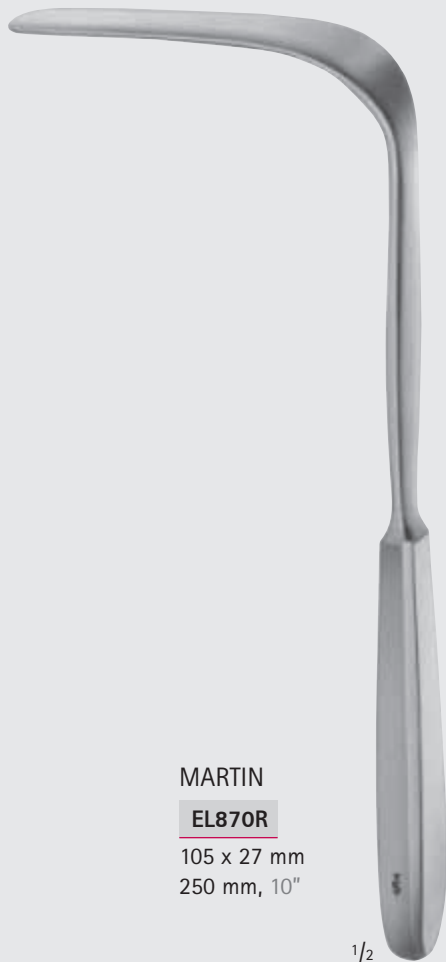

MARTIN

EL870R

105 x 27 mm
250 mm, 10"

1/2



SIMON

EL872R

115 x 22 mm
275 mm, 10 3/4"

1/2



SIMON

EL873R

115 x 26 mm
275 mm, 10 3/4" 1/2

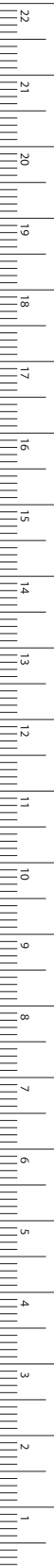

Scheidenspekula – Vaginal Specula

Scheidenspekula

Vaginal Specula

Scheidenspekula

Schema für Maßangaben bei Spekula

Vaginal specula

How to measure vaginal specula

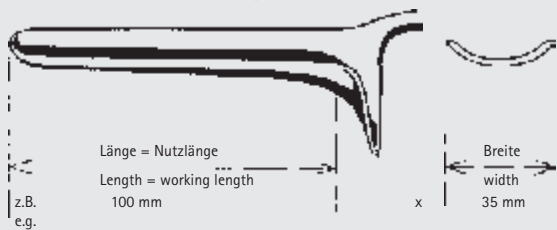

AUVARD

EL736R

65 x 38 - 28 mm

1,530 kg = 3 lbs. 6 oz.
mit abnehmbarem Gewicht

1.530 kg = 3 lbs. 6 oz.
with detachable weight
230 mm, 9"



AUVARD

EL738R 75 x 42 - 40 mm

EL739R 105 x 43 - 40 mm

1,470 kg = 3 lbs. 4 oz.
mit abnehmbarem Gewicht

1.470 kg = 3 lbs. 4 oz.
with detachable weight
230 mm, 9"



Scheidenspekula – Vaginal Specula

Scheidenspekula
Vaginal Specula

73

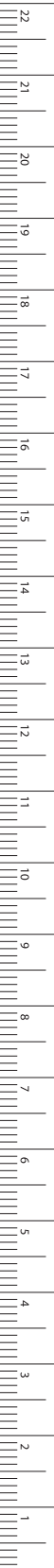

EL741R

80 x 30 mm



EL744R

55 x 40 - 60 mm



EL742R

85 x 35 mm



EL743R

85 x 40 mm

EL745R

70 x 45 - 70 mm

EL748R



EL746R

EL747R

1/3

Die Blätter sind austauschbar.
Sie passen sowohl auf den Griff EL746R,
als auch auf die Griffe EL759R und EL760R,
siehe Seite 658

The blades can be exchanged.
They fit handle EL746R as well as
handles EL759R and EL760R,
see page 658

SCHERBACK

EL740R

Satz, bestehend aus:

Griff (EL746R)

Gewicht (EL747R)

4 Blätter (EL741R - EL744R)

Set, consisting of:

Handle (EL746R)

Weight (EL747R)

4 Blades (EL741R - EL744R)

MILLIMETERS

Scheidenspekula – Vaginal Specula

Scheidenspekula

Vaginal Specula

Scheidenspekula

Schema für Maßangaben bei Spekula

Vaginal specula

How to measure vaginal specula

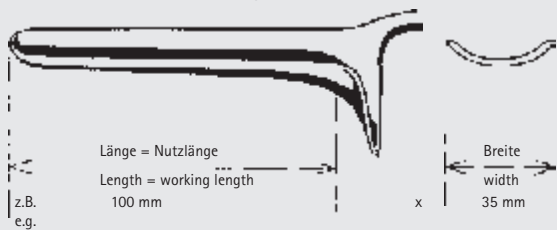

EL755R

80 x 30 mm



EL751R

65 x 30 mm



EL756R

85 x 33 mm



EL752R

75 x 35 mm



EL757R

100 x 38 mm



EL753R

85 x 35 mm



EL758R

110 x 42 mm



EL754R

95 x 35 mm



$\frac{1}{3}$

EL759R

230 mm, 9"



$\frac{1}{3}$

EL760R

220 mm, 8 $\frac{3}{4}$ "

Die Blätter sind austauschbar.

Sie passen sowohl auf den Griff EL746R,
als auch auf die Griffe EL759R und EL760R

The blades can be exchanged.

They fit handle EL746R as well as
handles EL759R and EL760R



Scheidenspekula – Vaginal Specula
Vulva-Spreizer
Vaginal Retractor

73

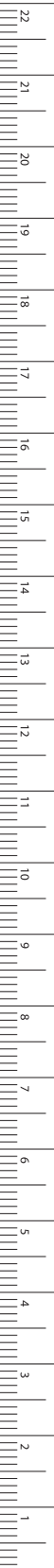

MILLIMETERS



JOLL (FRIEDMANN)

BV087R

155 mm, 6"



GELPI

BV996R

135 mm, 5 1/4"

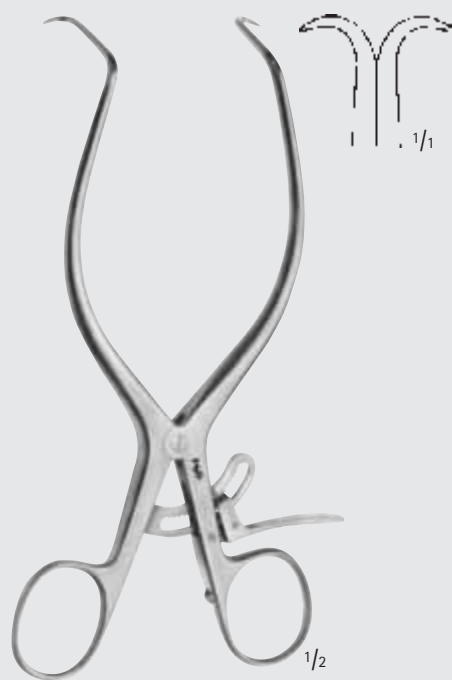

GELPI

BV997R

175 mm, 7"



INCHES

EM



Uterus-Dilatatoren
Uterine Dilators

Uterus-Dilatatoren – Uterine Dilators

Uterus-Dilatatoren

Uterine Dilators

EM



1/2

EM101R	1 mm	EM114R	14 mm	EM131R	1 1/2 mm	EM144R	14 1/2 mm
EM102R	2 mm	EM115R	15 mm	EM132R	2 1/2 mm	EM145R	15 1/2 mm
EM103R	3 mm	EM116R	16 mm	EM133R	3 1/2 mm	EM146R	16 1/2 mm
EM104R	4 mm	EM117R	17 mm	EM134R	4 1/2 mm	EM147R	17 1/2 mm
EM105R	5 mm	EM118R	18 mm	EM135R	5 1/2 mm		
EM106R	6 mm	EM119R	19 mm	EM136R	6 1/2 mm		
EM107R	7 mm	EM120R	20 mm	EM137R	7 1/2 mm		
EM108R	8 mm	EM121R	21 mm	EM138R	8 1/2 mm		
EM109R	9 mm	EM122R	22 mm	EM139R	9 1/2 mm		
EM110R	10 mm	EM123R	23 mm	EM140R	10 1/2 mm		
EM111R	11 mm	EM124R	24 mm	EM141R	11 1/2 mm		
EM112R	12 mm	EM125R	25 mm	EM142R	12 1/2 mm		
EM113R	13 mm	EM126R	26 mm	EM143R	13 1/2 mm		

HEGAR

EM101R-EM147R

mit stark konischer Spitze

with very conical point

185 mm, 7 1/4"



1/2

EM231R	1 + 2 mm
EM232R	3 + 4 mm
EM233R	5 + 6 mm
EM234R	7 + 8 mm
EM235R	9 + 10 mm
EM236R	11 + 12 mm
EM237R	13 + 14 mm
EM238R	15 + 16 mm
EM239R	17 + 18 mm

HEGAR

EM231R-EM239R

195 mm, 7 3/4"



Uterus-Dilatatoren – Uterine Dilators

Uterus-Dilatatoren
Uterine Dilators

EM

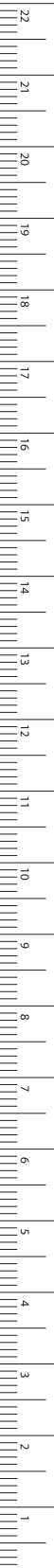

MILLIMETERS

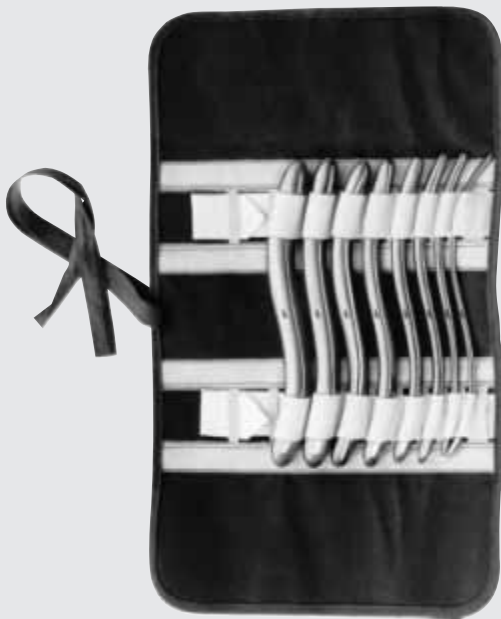

HEGAR

EM244R

Uterus-Dilatatoren,
in Segeltuchtasche (EM245),
mit 8 Dilatoren (EM232R-EM239R)

Uterine dilator set,
in canvas roll (EM245),
with 8 dilators (EM232R-EM239R)



EM271R 13 - 15 Char.

EM272R 17 - 19 Char.

EM273R 21 - 23 Char.

EM274R 25 - 27 Char.

EM275R 29 - 31 Char.

EM276R 33 - 35 Char.

EM277R 37 - 39 Char.

EM278R 41 - 43 Char.

PRATT

EM271R-EM278R

290 mm, 11 1/2"

1/2

Uterus-Dilatatoren – Uterine Dilators

Uterus-Dilatatoren – komplette Sätze

Uterine Dilators – Complete Sets



HEGAR

EM193R

Dilatatoren-Satz,
bestehend aus:

EM104R-EM117R	14 Dilatatoren
EM097R	1 Lagerungssieb für Dilatatoren 4-12 mm
EM098R	1 dto. für Dilatatoren 13-17 mm
JG161R	1 Metalletui allein, mit Scharnierdeckel, 200 x 100 x 35 mm, nichtrostend

Dilator set,
consisting of:

EM104R-EM117R	14 Dilators
EM097R	1 Rack for dilators 4-12 mm
EM098R	1 Rack for dilators 13-17 mm
JG161R	1 Metal case only, with hinged lid, 200 x 100 x 35 mm, stainless,



HEGAR

EM194R

Dilatatoren-Satz,
bestehend aus:

EM101R-EM126R	26 Dilatatoren
EM099R	1 Lagerungssieb für Dilatatoren 1-17 mm
EM100R	1 dto. für Dilatatoren 18-26 mm
JG170R	1 Metalletui allein, mit Alu-Scharnierdeckel, 330 x 220 x 80 mm

Dilator set,
consisting of:

EM101R-EM126R	26 Dilators
EM099R	1 Rack for dilators 1-17 mm
EM100R	1 Rack for dilators 18-26 mm
JG170R	1 Metal case only, with hinged lid of aluminium, 330 x 220 x 80 mm



Uterus-Dilatatoren – Uterine Dilators

Sterilgutlagertechnik für Dilatatoren

Suggestions for Sterile Storage of Dilators



Weitere Informationen finden Sie in unserem Prospekt C404.
For further details see brochure No. C404.

Gleitschieber-Halterung

zur übersichtlichen und zweckmäßigen Lagerung von Dilatatoren, Bougies, Kathetern und dergleichen.

Schiene und Anschlagrahmen können beliebig in den Siebkörben oder auf den Siebböden angeordnet werden. Die Gleitschieber sind auf der Schiene verschiebbar und werden durch einen Federmechanismus arretiert. Auf Wunsch können die Gleitschieber mit Kennzeichnungen versehen werden.

Sliding rail

with adjustable dividers for clear and suitable storage of dilators, bougies, catheters and suchlike.

Sliding rail as well as limiting bar can be optionally arranged in the wire baskets or on the wire bases. On the rail the dividers are slidable and are fixed by a spring mechanism. On demand, the dividers can be marked with identifications.

Pack- und Lagerungsbeispiele

Examples for arranging and storing

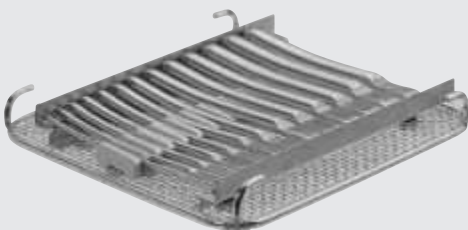

JF910R-JF908R

Uterus-Dilatatoren (ca. 12-16 Stück)

- JF910R 1 Siebboden oder
- JF489R 1 Siebkorb
- JF906R 1 Schiene
- JF905 15 Gleitschieber
- JF908R 2 Anschlagrahmen

Uterine dilators (approx. 12-16 pieces)

- JF910R 1 wire base or
- JF489R 1 wire basket
- JF906R 1 sliding rail
- JF905 15 dividers
- JF908R 2 limiting bars

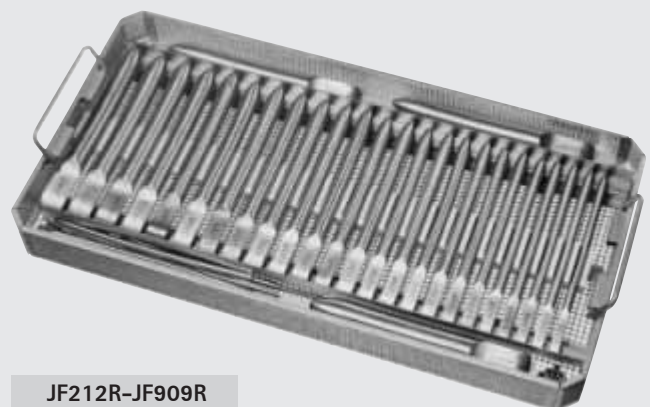

JF212R-JF909R

Uterus-Dilatatoren (ca. 26-30 Stück)

- JF212R 1 Siebkorb oder
- JF915R 1 Siebboden
- JF907R 1 Schiene
- JF905 31 Gleitschieber
- JF909R 2 Anschlagrahmen

Uterine dilators (approx. 26-30 pieces)

- JF212R 1 wire basket or
- JF915R 1 wire base
- JF907R 1 sliding rail
- JF905 31 dividers
- JF909R 2 limiting bars

EM

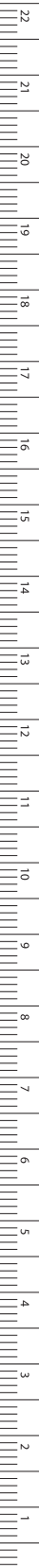

MILLIMETERS

Uterus-Dilatatoren – Uterine Dilators

Steritgutlagertechnik für Dilatatoren

Suggestions for Sterile Storage of Dilators

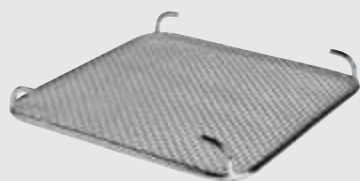

JF910R

Siebboden
mit Griffen zum Herausheben
Wire base
with handle hooks to lift out
258 x 258 x 32 mm

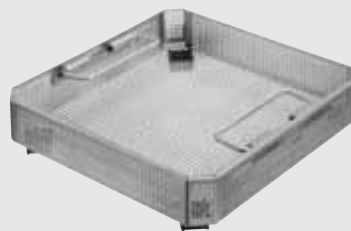

JF112R

Siebkorb
Griffbeweglichkeit 90°,
senkrecht - waagrecht
Wire basket
handles can be moved up to 90° angle,
vertical - horizontal
257 x 245 x 50 mm

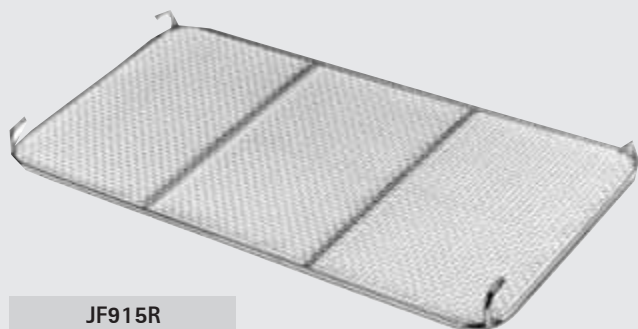

JF915R

Siebboden
mit Griffen zum Herausheben
Wire base
with handle hooks to lift out
544 x 257 x 32 mm

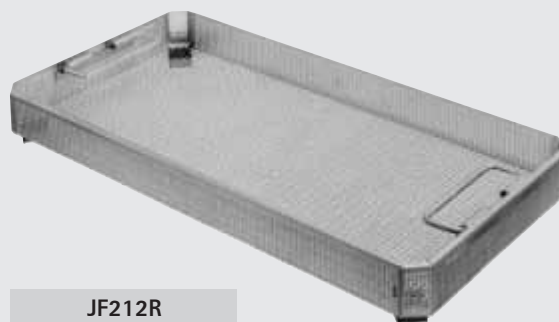

JF212R

Siebkorb
Griffbeweglichkeit 90°,
senkrecht - waagrecht
Wire basket
handles can be moved up to 90° angle,
vertical - horizontal
485 x 257 x 50 mm



JF905

Gleitschieber
auf den Schienen JF906R und
JF907R individuell verschiebbar
Divider
to be used on sliding rails
JF906R and JF907R



Länge
Length

JF906R	232 mm
JF907R	471 mm

Schiene DBGM
für Gleitschieber JF905,
mit Befestigungsschrauben
Sliding rails DBGM
with securing screws,
for divider JF905



Länge
Length

JF908R	232 mm
JF909R	471 mm

Anschlagrahmen DBGM
speziell zur Lagerung von Dilatatoren,
mit Befestigungsschrauben
Limiting bars DBGM
with securing screws,
particularly useful for storing dilators



Uterus-Dilatatoren – Uterine Dilators

Endospekula für Cervix und Harnröhre
Endospecula for Cervix and Urethra

EM



KOGAN

EM710R

ohne Sperre
without ratchet
240 mm, 9 1/2"

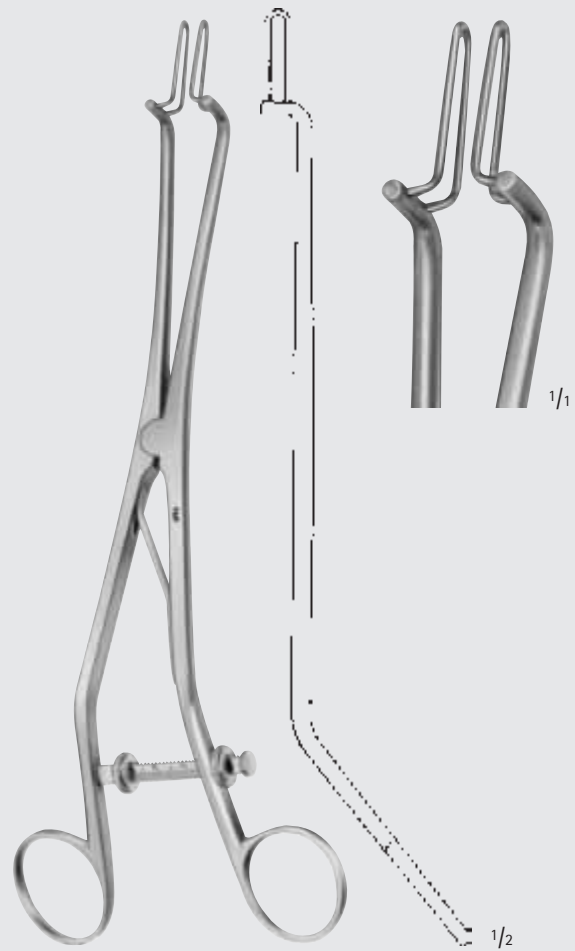

KOGAN

EM711R

mit Skalensperre und
Fixierschraube
with scale-ratchet and
fixing screw
240 mm, 9 1/2"

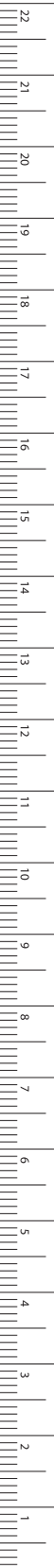



INCHES

EO



**Uterussonden, Tampon-, Haken-,
Uterusfasszangen**
Uterine Probes, Uterine Dressing-,
Tenaculum and Uterine Elevating Forceps

Uterussonden – Uterine Probes

Uterussonden

Uterine Probes

EO



Knopf-Ø 5 mm
Diam. of tip



1/2

MAYO

EO005R

biegsam
malleable
330 mm, 13 1/8"

Knopf-Ø 4 mm
Diam. of tip

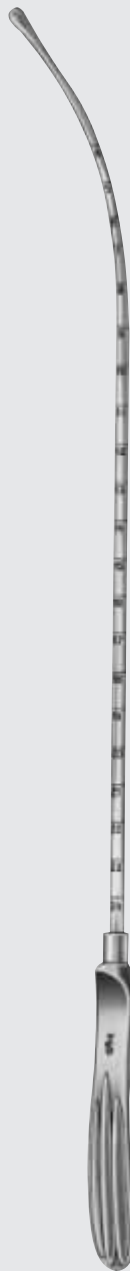

1/2

SIMS

EO010R

330 mm, 13"

EO012R

biegsam
malleable
330 mm, 13"

Knopf-Ø 3,6 mm
Diam. of tip



1/2

GALABINS

EO013R

Schaft graduert in cm,
biegsam

Schaft graduated in cm,
malleable
295 mm, 11 3/4"

Knopf-Ø 3 mm
Diam. of tip



1/2

MARTIN

EO015R

300 mm, 12"



Uterussonden – Uterine Probes Uterussonden, Uterus-Depressor Uterine Probes, Uterine Depressor

EO

Knopf-Ø 4 mm
Diam. of tip



VALLEIX

EO016R

graduiert,
mit Schieber
graduated,
with slider
250 mm, 10"

Knopf-Ø 4 mm
Diam. of tip



SIMPSON

EO020

biegsam,
versilbert
malleable,
silver-plated
310 mm, 12 1/4"



BRAUN

EO030R

Uterus-Depressor
Uterine depressor
270 mm, 10 3/4"

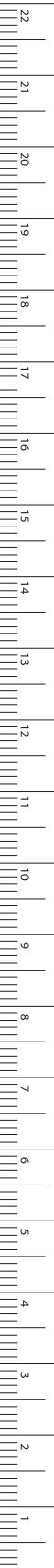

MILLIMETERS

Uterussonden – Uterine Probes

Tamponzangen

Uterine Dressing Forceps

EO

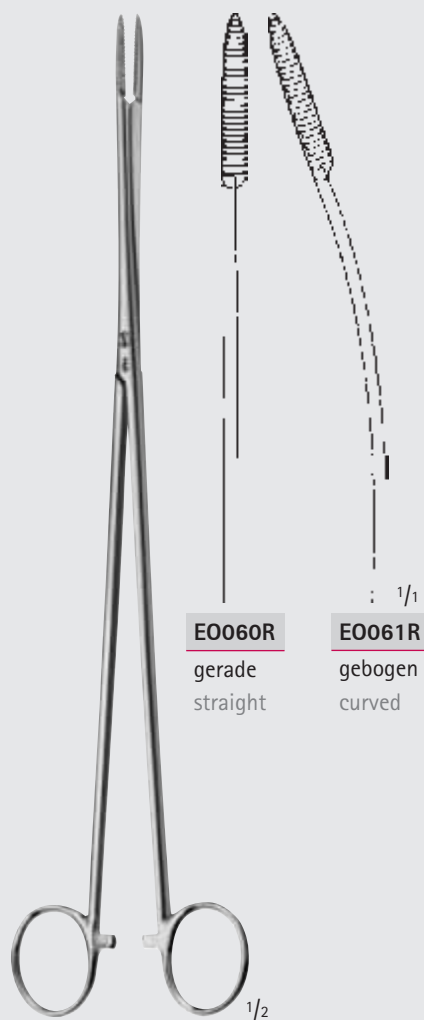

EO060R
gerade
straight

EO061R
gebogen
curved

PELKMANN

EO060R-EO061R

260 mm, 10 1/4"

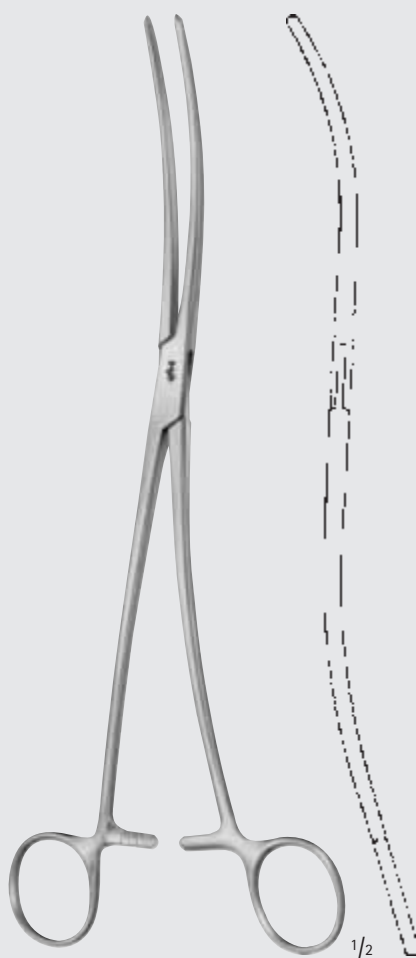

BOZEMANN

EO075R

250 mm, 10"

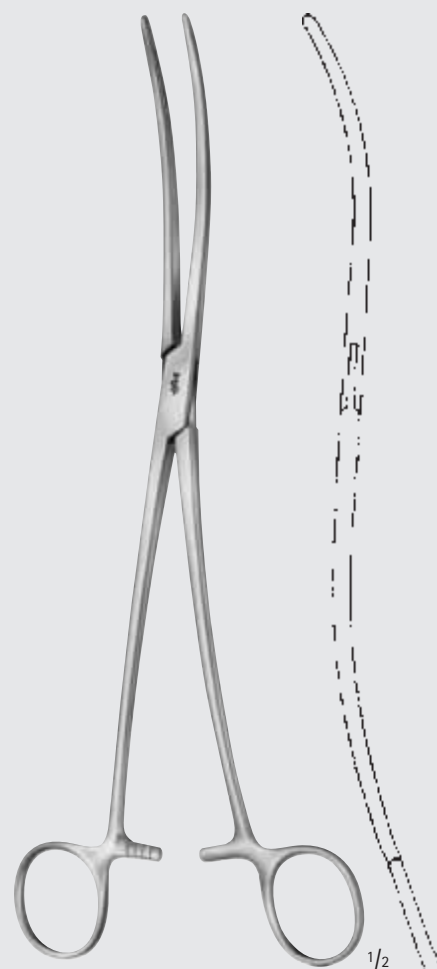

BOZEMANN

EO077R

Maul mit Längskehle
Jaws with longitudinal groove
255 mm, 10"



Uterussonden – Uterine Probes
Tamponzangen
Uterine Dressing Forceps

EO

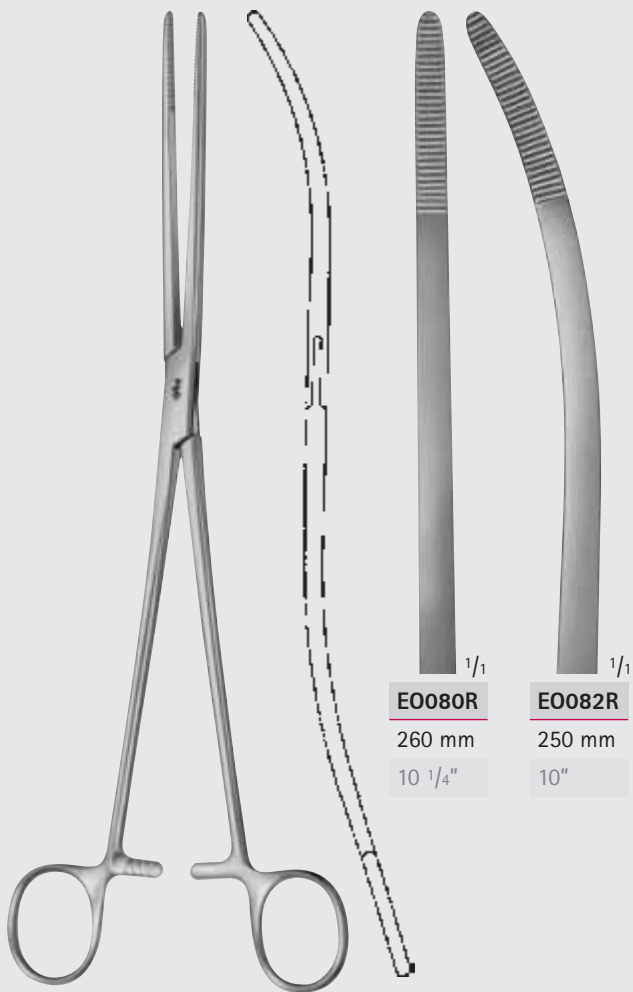

EO080R 260 mm 10 1/4"	EO082R 250 mm 10"
------------------------------------	--------------------------------

BOZEMANN
EO080R-EO082R

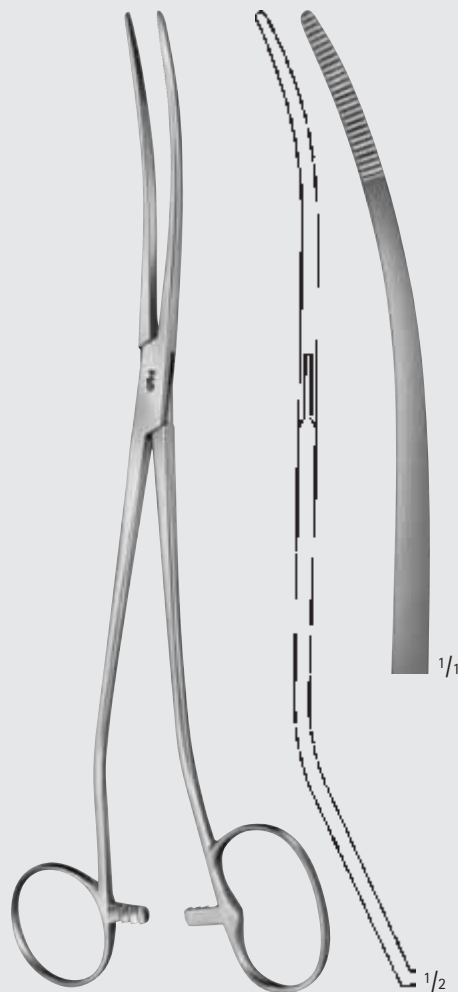

BOZEMANN-DOUGLAS
EO085R
260 mm, 10 1/4"

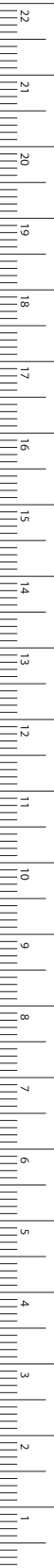

MILLIMETERS

Uterussonden – Uterine Probes

Hakenzangen

Uterine Tenaculum Forceps

EO

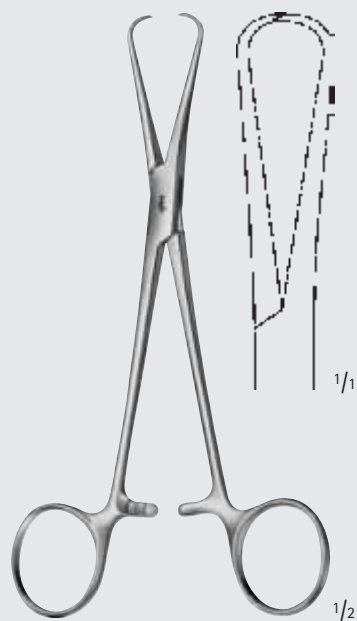

BERNHARD

BF426R

160 mm, 6 1/4"



POZZI

EO105R

175 mm, 7"



ADAIR

EO106R

190 mm, 7 1/2"



Uterussonden – Uterine Probes
Hakenzangen
Uterine Tenaculum Forceps

EO

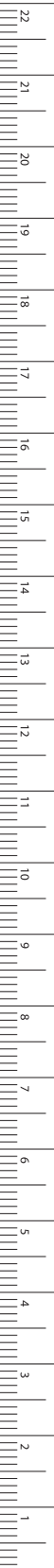

MILLIMETERS



BRAUN

EO108R

feines Modell
slender pattern
250 mm, 10"



COLLIN-POZZI

EO122R

250 mm, 10"



SCHRÖDER

EO110R

Standard Modell
Standard pattern
250 mm, 10"

Uterussonden – Uterine Probes

Hakenzangen

Uterine Tenaculum Forceps

EO



SCHRÖDER

EO111R

250 mm, 10"



WILSON

EO112R

240 mm, 9 1/2"



POZZI

EO125R

kräftiges Modell
heavy pattern
255 mm, 10"



Uterussonden – Uterine Probes
Hakenzangen
Uterine Tenaculum Forceps

EO



MARTIN

EO115R

265 mm, 10 1/2"

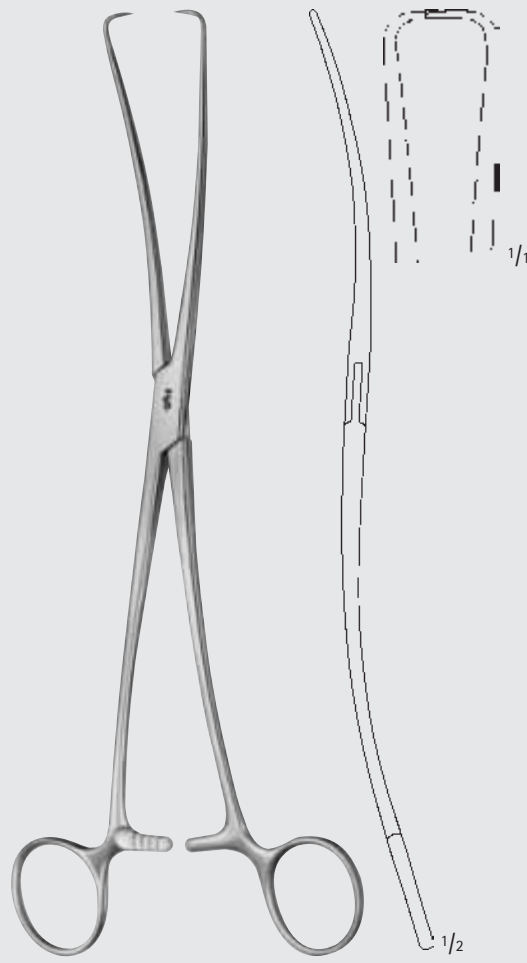

DUPLAY

EO130R

250 mm, 10"

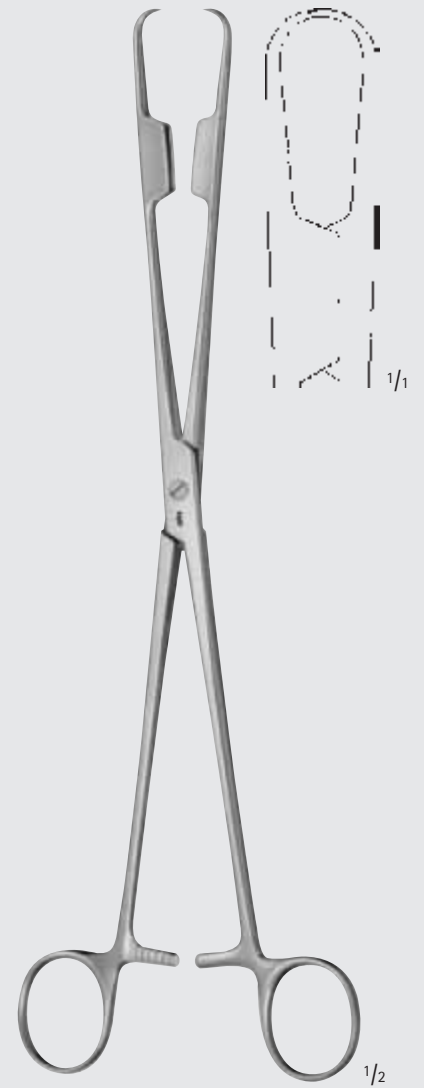

ABEL

EO140R

280 mm, 11"

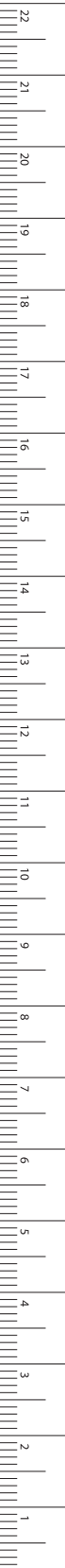

MILLIMETERS

Uterussonden – Uterine Probes

Hakenzangen

Uterine Tenaculum Forceps

EO

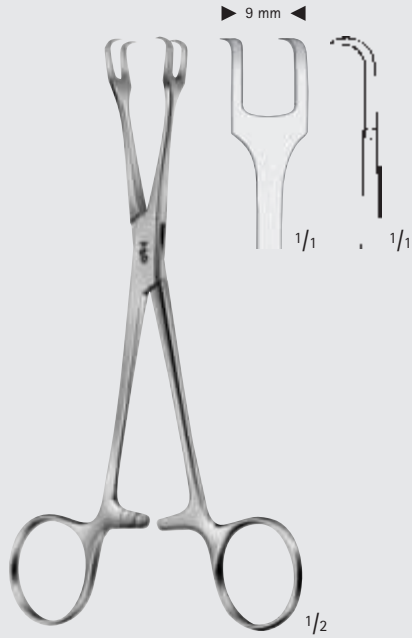

LAHEY

BF309R

155 mm, 6"

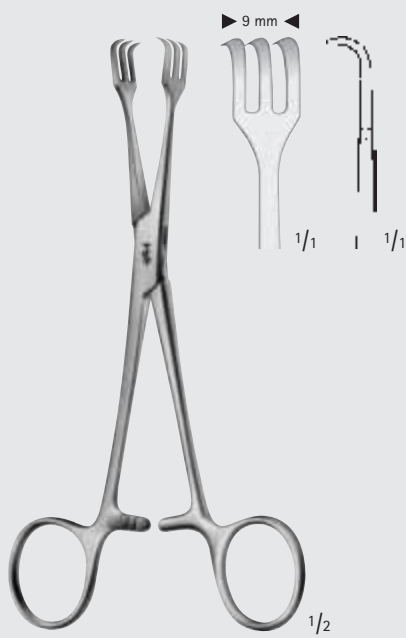

LAHEY

BF310R

155 mm, 6"

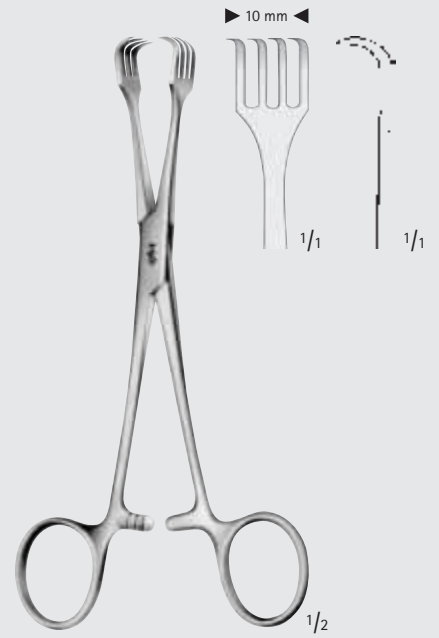

BRAUN

BF311R

155 mm, 6"

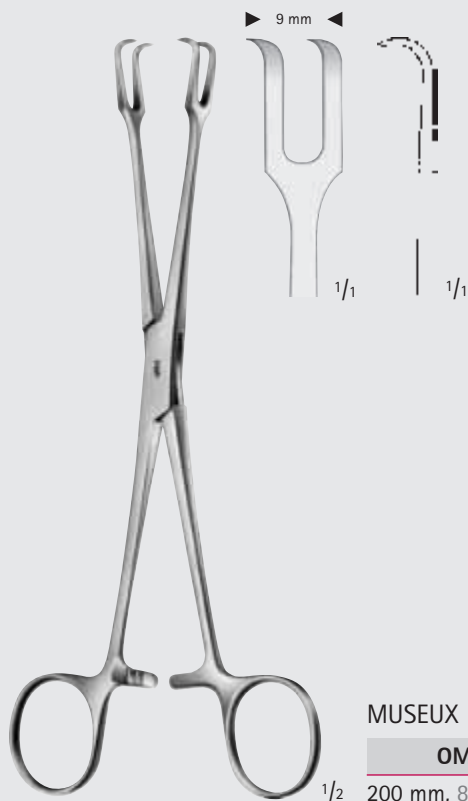

MUSEUX

OM602R

200 mm, 8"

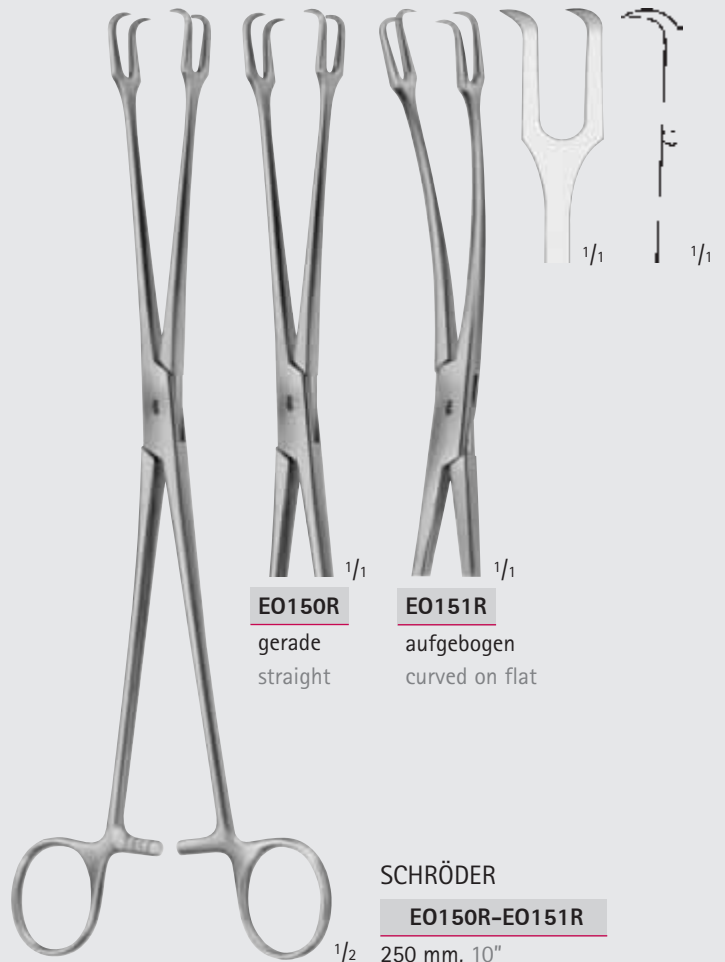

EO150R

gerade
straight

EO151R

aufgebogen
curved on flat

SCHRÖDER

EO150R-EO151R

250 mm, 10"



Uterussonden – Uterine Probes
Hakenzangen
Uterine Tenaculum Forceps

EO

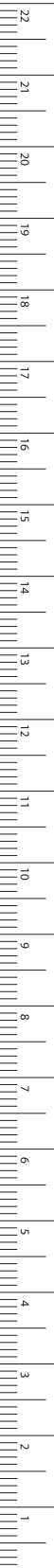

MILLIMETERS



CZERNY

EO164R

200 mm, 8"



SCHRÖDER

EO163R

270 mm, 10 3/4"

Uterussonden – Uterine Probes

Hakenzangen

Uterine Tenaculum Forceps

EO



AESCULAP-PRATT

EO165R

260 mm, 10 1/4"

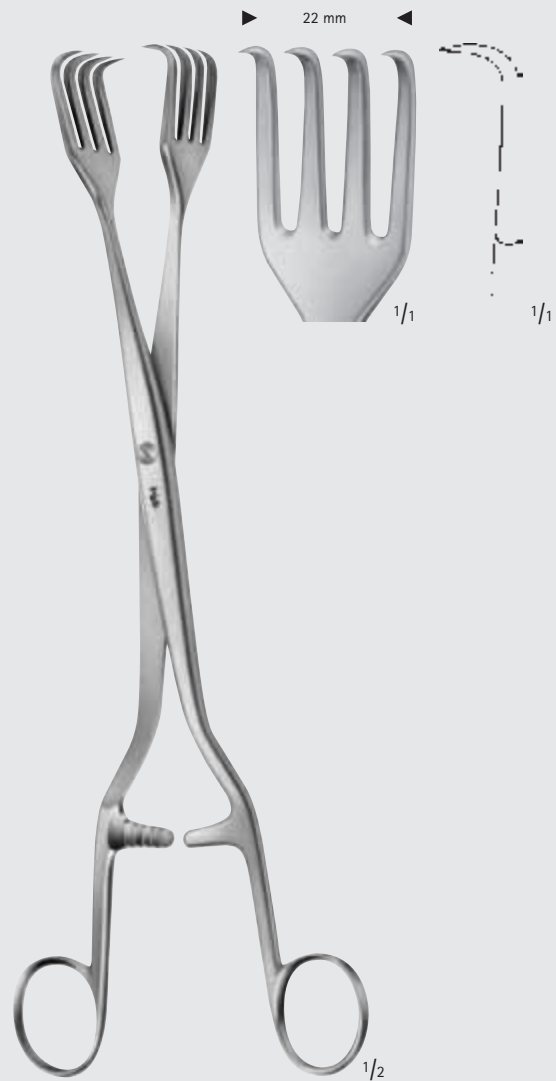

PRATT

EO166R

270 mm, 10 3/4"



Uterussonden – Uterine Probes
Hakenzangen
Uterine Tenaculum Forceps

EO

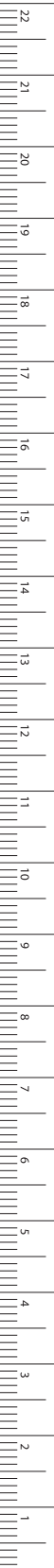

MILLIMETERS



KÜSTNER

E0171R

250 mm, 10"



TEALE

E0177R

180 mm, 7"

Uterussonden – Uterine Probes
Hakenzangen
Uterine Tenaculum Forceps

EO



TEALE
EO180R
255 mm, 9"



JACOBS
EO202R
215 mm, 8 1/2"



Uterussonden – Uterine Probes
Hakenzangen
Uterine Tenaculum Forceps

EO

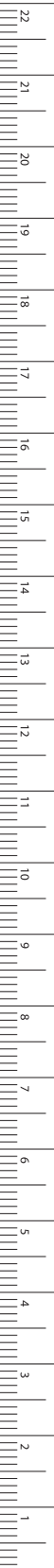

MILLIMETERS



LITTLEWOOD

EO216R

185 mm, 7 1/4"



MUSEUX

EO218R

200 mm, 8"

Uterussonden – Uterine Probes

Hakenzangen

Uterine Tenaculum Forceps

EO

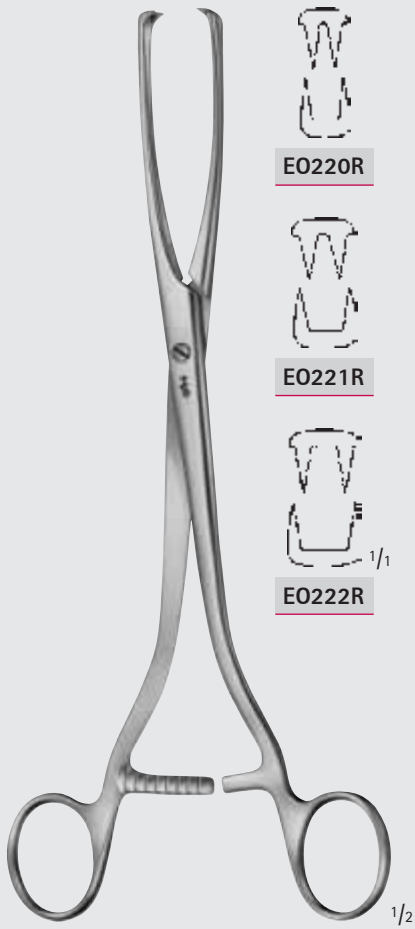

EO220R

EO221R

EO222R

1/2

MUSEUX

EO220R-EO222R

240 mm, 9 1/2"

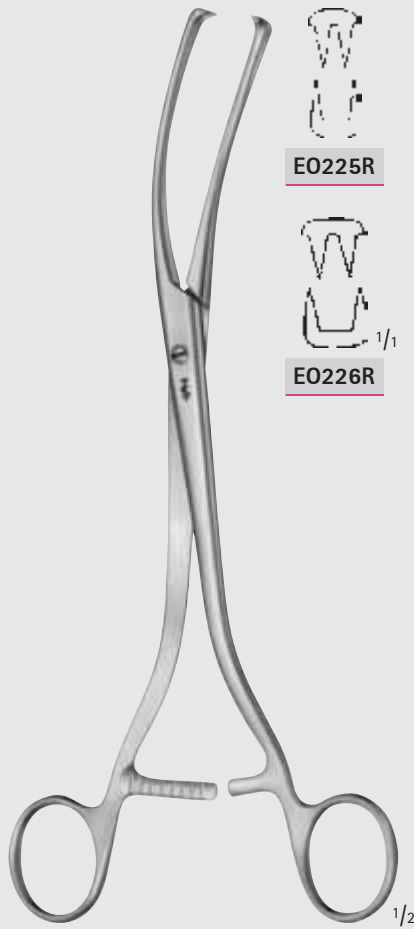

EO225R

EO226R

1/2

MUSEUX

EO225R-EO226R

seitwärts gebogen
curved to side
240 mm, 9 1/2"



EO240R

EO242R

1/2

MUSEUX

EO240R-EO242R

265 mm, 10 1/2"



Uterussonden – Uterine Probes
Polypen- und Ovarienzangen
Polypus- and Ovum Forceps

EO



HEYWOOD-SMITH

AN710R

200 mm, 8"

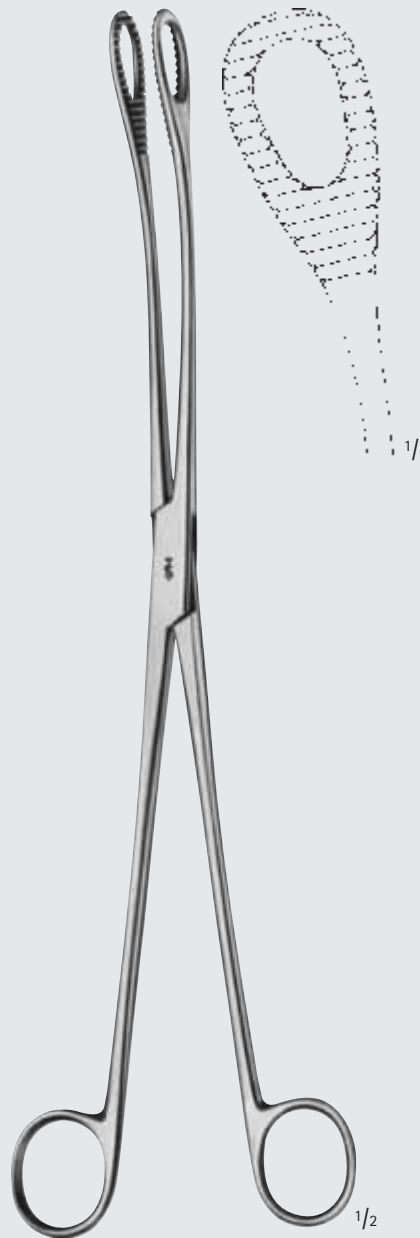

KELLY

BF135R

320 mm, 12 3/4"

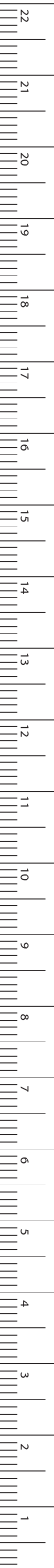

MILLIMETERS

Uterussonden – Uterine Probes

Polypen- und Ovarienzangen

Polypus- and Ovum Forceps

EO

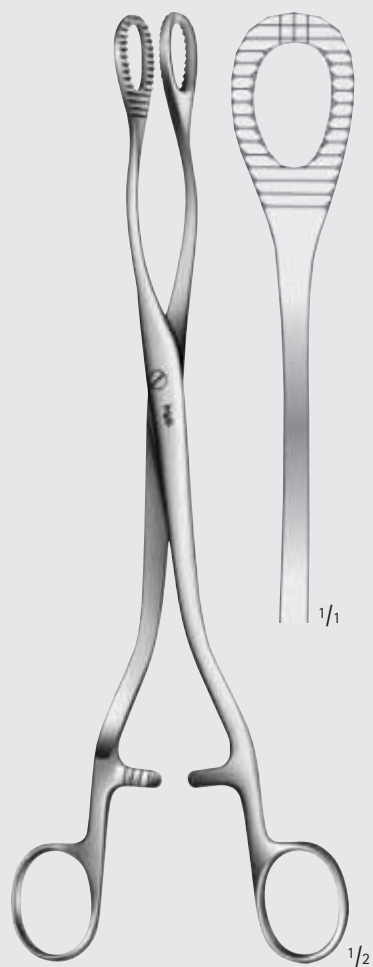

HEYWOOD-SMITH

E0310R

250 mm, 10"

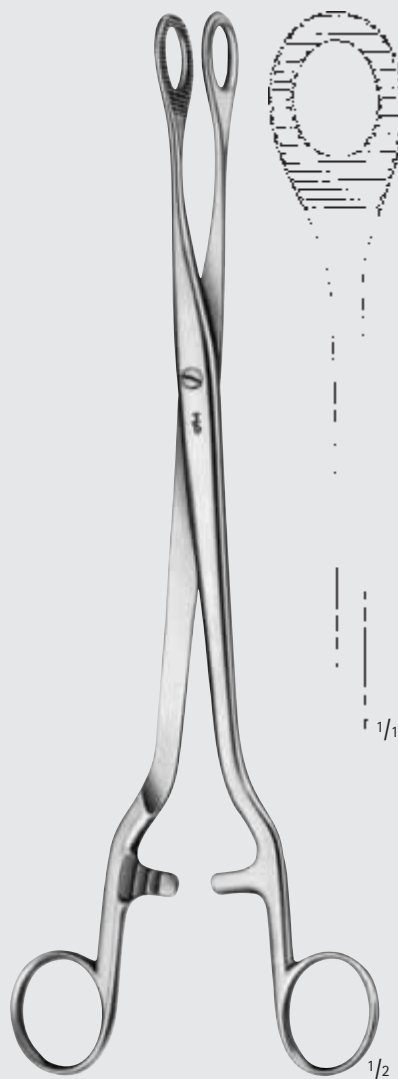

NOTO

E0315R

280 mm, 11"



Uterussonden – Uterine Probes
 Polypen- und Ovarienzangen
 Polypus- and Ovum Forceps

EO

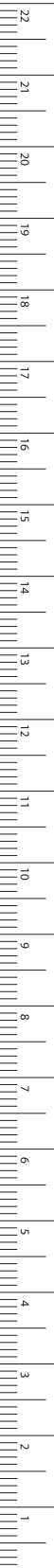

MILLIMETERS

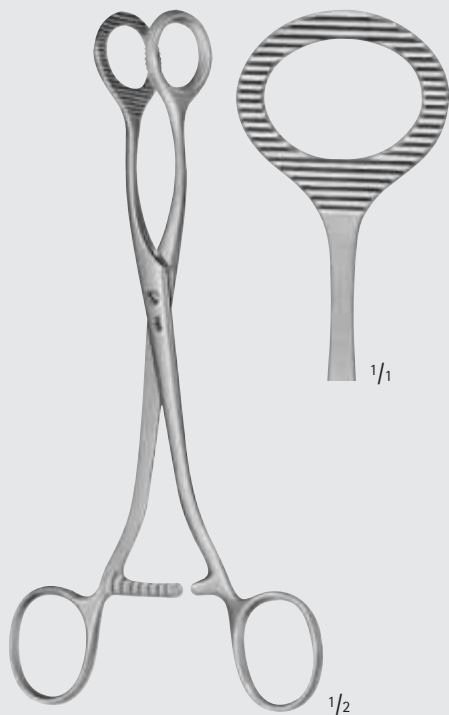

DOYEN

EO332R

185 mm, 7 1/4"

AIRAUMATA®



21 mm

27 mm

EO338R

EO340R

EO338R 250 mm 10"

EO340R 270 mm 10 3/4"

Uterussonden – Uterine Probes

Polypen- und Ovarienzangen, Uterusfasszangen

Polypus- and Ovum Forceps, Uterine Elevating Forceps

EO

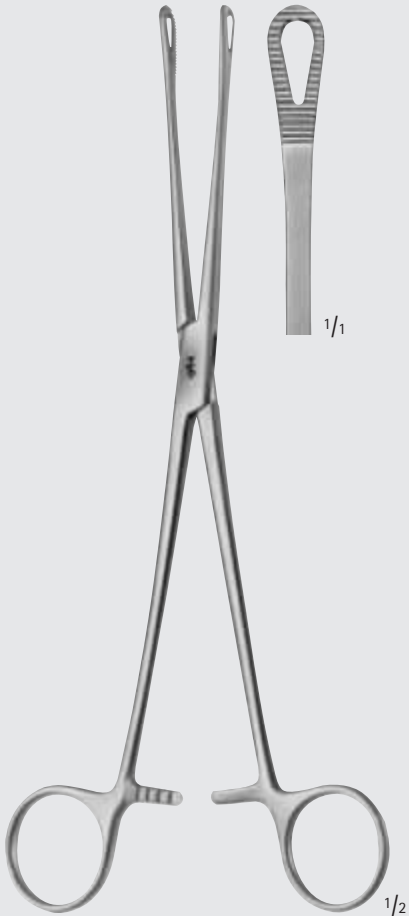

BONNEY

EO342R

240 mm, 9 1/2"



COLLIN

EO300R

250 mm, 10"



COLLIN

EO405R

285 mm, 11 1/4"



Uterussonden – Uterine Probes
Uterusfazzangen
Uterine Elevating Forceps

EO



1/2

DARTIGUES

EO407R

255 mm, 10"



1/2

SOMER

EO415R

235 mm, 9 1/4"



mit beweglichen Maulteilen
with movable jaws

1/2

COLLIN

EO420R

265 mm, 10 1/2"

MILLIMETERS

Uterussonden – Uterine Probes

Myomheber

Myoma Screws

EO



DOYEN

EO433R

150 mm, 6"



DOYEN

EO435R

190 mm, 7 1/2"



Uterussonden – Uterine Probes

Modifiziertes Instrumentarium für die Wertheimsche Operation Modified Instruments for Radical Hysterectomy

Die Austunnung des blasennahen Ureters und das Absetzen der Parametrien sind die charakteristischen Bestandteile bei der Wertheimschen Operation. Für das Austunneln des Ureters gibt es verschiedene Vorgehensweisen. Das Risiko der Ureter-Verletzung, das allen diesen Vorgehensweisen gemeinsam ist, ist bedingt durch das wiederholte Anklebmen, Spreizen und Durchtrennen von Gewebe in unmittelbarer Nähe des Ureters ohne direkte visuelle Kontrolle. Die Durchtrennung der Parametrien ist ein weiterer kritischer Operationsschritt. Das Durchtrennen der Gewebsbündel ist oft technisch unbefriedigend und hinterläßt gezahnte Resektionsränder. Aesculap hat daher ein Instrumentarium entwickelt, das die oben genannten operativen Schritte sicherer und präziser macht. Das Instrumentarium ermöglicht es dem Chirurgen, den Eingriff sicherer und präziser durchzuführen und daraus folgt ein schonender OP-Verlauf für die Patientin. Das bislang bestehende Risiko von ungewollten Verletzungen bei dieser Radikaloperation beim Zervixkarzinom wird durch das Design der von Aesculap entwickelten Instrumente minimiert.

Tunneling of the ureter and severance of the parametria are the characteristic components of the Wertheim operation. There are various procedures for tunnelling the ureter. The risk of injury to the ureter, which is common to all these procedures, is due to the repeated clamping, separation and severance of tissues in the immediate proximity of the ureter without direct visual monitoring. The severance of the parametria is another critical step in the operation. The severance of the tissue bundles is often technically unsatisfactory and leaves serrated resection edges. Aesculap has therefore developed an instrument set which makes the operating steps mentioned safer and more precise. The instrument set enables the surgeon to carry out the operation more safely and precisely, resulting in a less traumatic operation for the patient. The existing risk of undesired injuries in this radical operation for carcinoma of the cervix is minimized by the design of the instruments developed by Aesculap.

EO



MILLIMETERS



UCHIDA (MODIF. N. BURKE)

BM976R	270 mm	10 3/4"
BM977R	350 mm	14"

Ureterlöffel
Spoons



BJ075R	BJ076R
235 mm	350 mm
9 1/4"	14"

KIEBACK

BJ075R-BJ076R

Ureter-Tunnelier-Klemmen,
seitwärts gebogen
Ureteral tunnel clamps,
curved to side

Uterussonden – Uterine Probes

Modifiziertes Instrumentarium für die Wertheimsche Operation

Modified Instruments for Radical Hysterectomy

EO

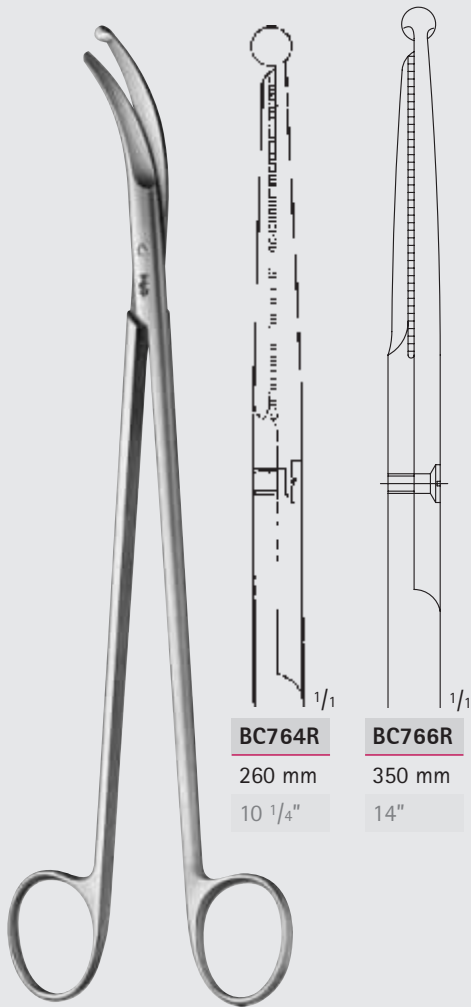

BC764R

260 mm

10 1/4"

BC766R

350 mm

14"

KIEBACK

BC764R-BC766R

Parametriumscheren, seitwärts gebogen, 1 Blatt mit Knopfspitze
Parametrium scissors, curved to side, with 1 probe pointed blade



BJ560R

250 mm

10"

BJ562R

350 mm

14"

BURKE

BJ560R-BJ562R

Parametriumklemmen, kurzes Maul
Parametrium clamps, short jaw part



Uterussonden – Uterine Probes

Modifiziertes Instrumentarium für die Wertheimsche Operation
Modified Instruments for Radical Hysterectomy

EO



BJ561R

250 mm

10"

BJ563R^{1/1}

350 mm

14"

BURKE

BJ561R-BJ563R

Parametriumklemmen, langes Maul
Parametrium clamps, long jaw part



BC763R

240 mm

9 1/2"

BC765R^{1/1}

350 mm

14"

KIEBACK

BC763R-BC765R

Parametriumscheren
Parametrium scissors

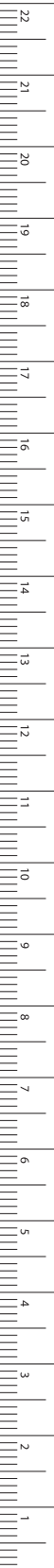

MILLIMETERS



ER



Biopsie- und Kürettage-Instrumente
Biopsy Instruments and Currettes

Biopsie- und Kürettage-Instrumente – Biopsy Instruments and Curettes

Skalpellgriffe und Skalpellklingen Scalpel Handles and Scalpel Blades

ER

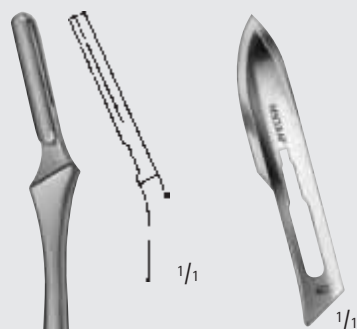

BB540

auswechselbare Skalpellklingen,
doppelschneidig
interchangeable scalpel
blades, double cutting

Bestelleinheit:

PAK= Packung à 100 Stück

Sales unit:

PAK= Package of 100 pieces

BB079R

Skalpellgriff, winklig aufgebogen
Scalpel handle, angular curved

1/1 225 mm, 9"





Biopsie- und Kürettage-Instrumente – Biopsy Instruments and Curettes

Biopsieküretten, I.U.D.-Entfernungshaken
Biopsy Curettes, I.U.D. Removing Hook

ER



SAUNDERS

ER002R

I.U.D.-Entfernungshaken
I.U.D. Removing hook
320 mm, 12 1/2"



ASCH

ER005R

Sekretlöffel
Secretion scoop
200 mm, 8"

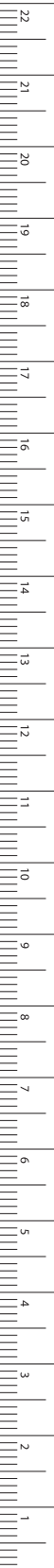

MILLIMETERS

Biopsie- und Kürettage-Instrumente – Biopsy Instruments and Curettes

Biopsieküretten

Biopsy Curettes

ER



1/1



1/1

Luer-Lock
Luer-Lock

Luer-Lock
Luer-Lock

1/2

1/2

NOVAK-SCHOECKAERT

RANDALL

ER011R

ER012R

Endometrium-Biopsiekürette
Endometrial biopsy curette
240 mm, 9 1/2"

Endometrium-Biopsiekürette
Endometrial biopsy curette
240 mm, 9 1/2"



1/1
Ø 3,5 mm
diam. 3.5 mm



1/1
Ø 4,0 mm
diam. 4.0 mm

1/2

1/2

MOD. BERLIN

MOD. MÜNCHEN

ER015R

ER016R

Endometrium-Strickkürette
Endometrial biopsy curette
270 mm, 10 3/4"

Endometrium-Strickkürette
Endometrial biopsy curette
270 mm, 10 3/4"



Biopsie- und Kürettage-Instrumente – Biopsy Instruments and Curettes

Biopsiezangen
Biopsy Forceps

ER

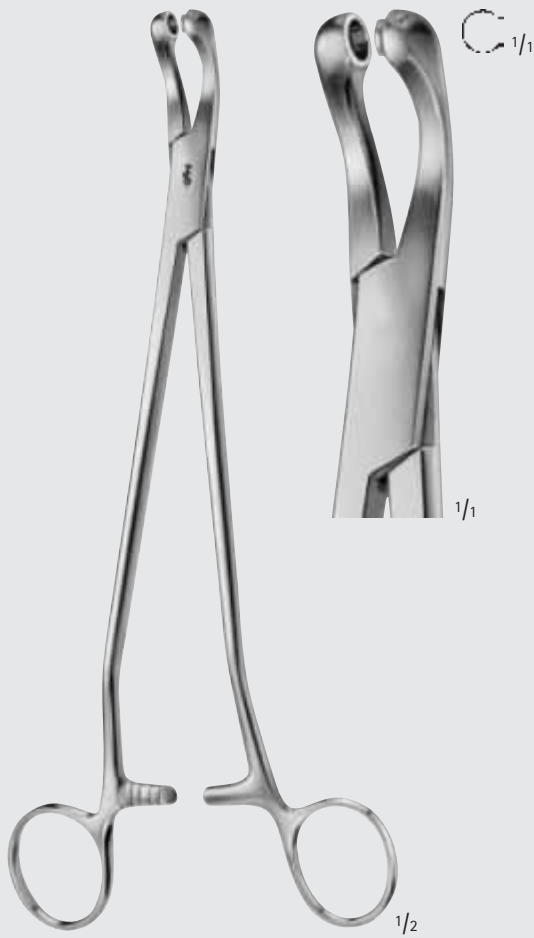

THOMS-GAYLOR

ER050R

240 mm, 9 1/2"

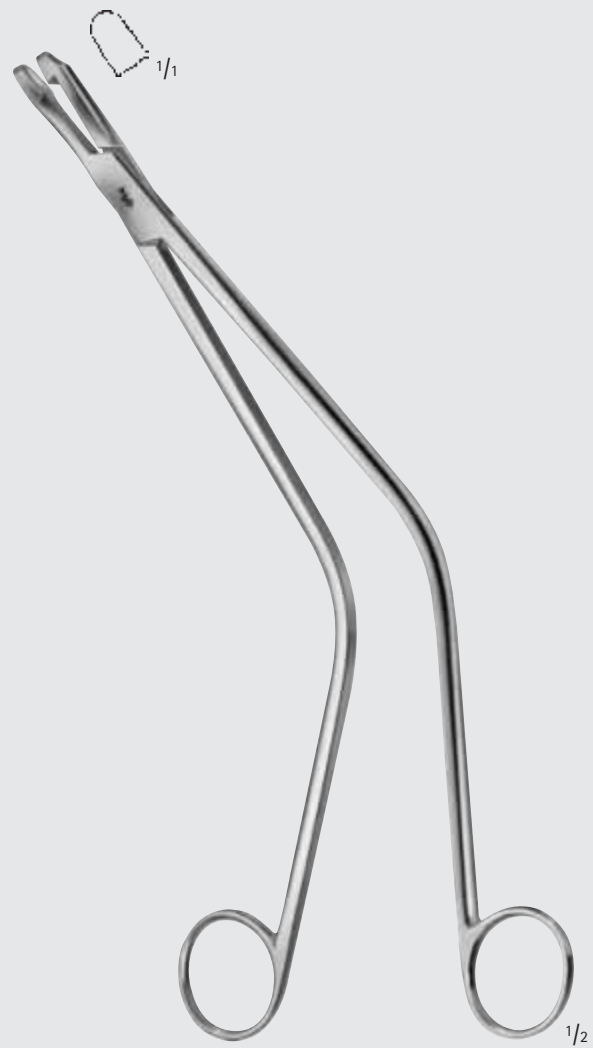

SCHUBERT

ER058R

260 mm, 10 1/4"

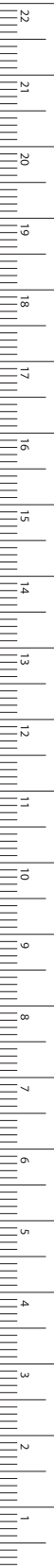

MILLIMETERS

Biopsie- und Kürettage-Instrumente – Biopsy Instruments and Curettes

Biopsiezangen
Biopsy Forceps

ER



FAURE

ER054R

210 mm, 8 1/4"



FAURE

ER055R

240 mm, 9 1/2"



Biopsie- und Kürettage-Instrumente – Biopsy Instruments and Currettes

Biopsiezangen Biopsy Forceps

Vorteile der SCHUMACHER-Zangen:

- Sicheres Erfassen des Gewebes aufgrund des Anhakeeffekts.
- Großer Öffnungswinkel.
- Glatter, ziehender Schnitt.
- Proben werden nicht gequetscht.
- Nicht schmerzhaft, selbstschließende Wunde, gute Heilung.

Advantages of the Schumacher forceps:

- More reliable grip on the tissue due to "hooking" effect.
- Wide angle of opening.
- Smooth, steady cut.
- Specimens are not squashed.
- Not painful; self-sealing wound, heals well.

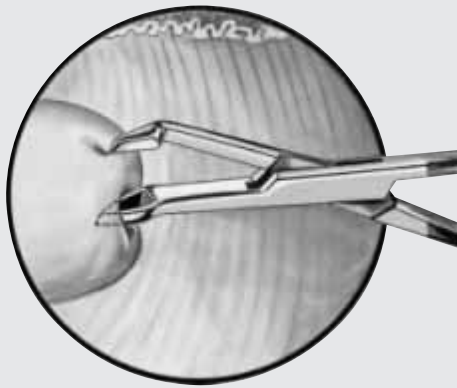

Zange an der Portio vaginalis uteri angesetzt.
Der gute Anhakeeffekt ist erkennbar.
Forceps applied to the portio vaginalis uteri.
The excellent hooking effect can be seen.

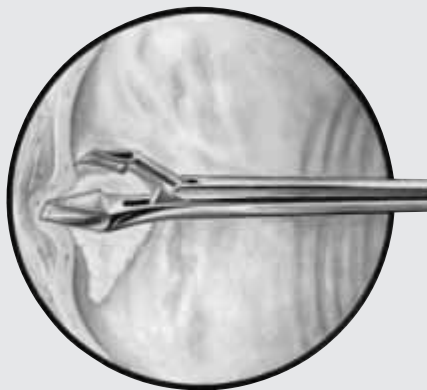

Zange am narbig veränderten flachen
Scheidengewölbe angesetzt.
Forceps applied to cicatricially altered flat
vaginal vault.

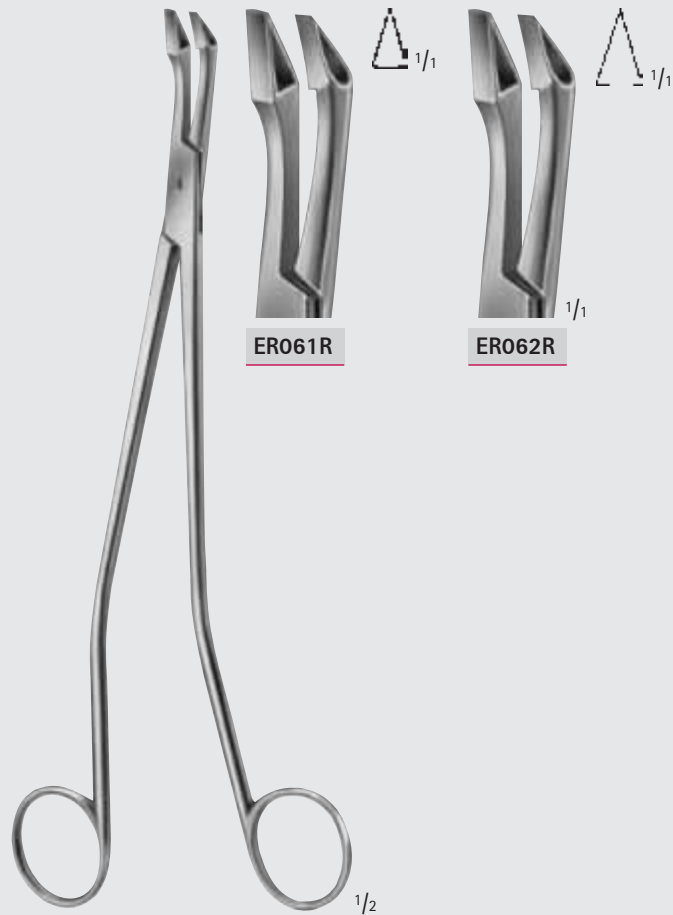

SCHUMACHER

ER061R-ER062R

240 mm, 9 1/2"

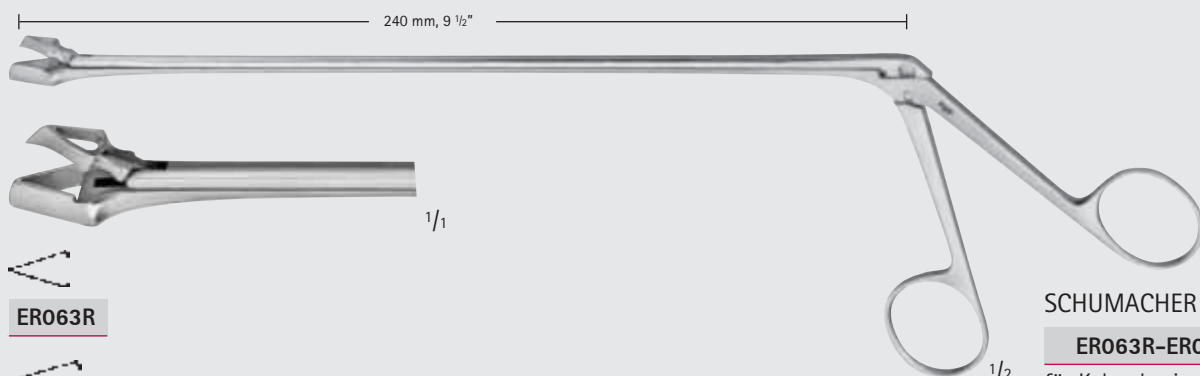

ER063R

ER064R

SCHUMACHER

ER063R-ER064R

für Kolposkopie geeignet
suitable for colposcopy
240 mm, 9 1/2"

ER

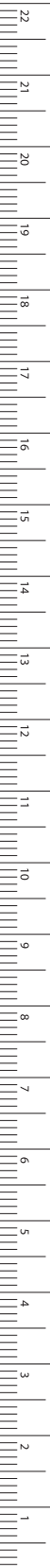

MILLIMETERS

Biopsie- und Kürettage-Instrumente – Biopsy Instruments and Currettes

Biopsiezangen Biopsy Forceps

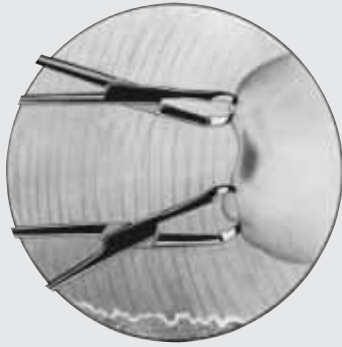

Die Größe des PE-Stücks wird durch den Öffnungswinkel der Zange bestimmt. Der Anhakeeffekt des gebogenen Zangenmaules ermöglicht eine Gewebeatnahme meist ohne zusätzliche Verwendung einer fixierenden Hakenzange.

The size of the biopsy is determined by the opening angle of the forceps. The hook effect of the curved jaws allows tissue removal and an additional hook forceps is hardly ever necessary.

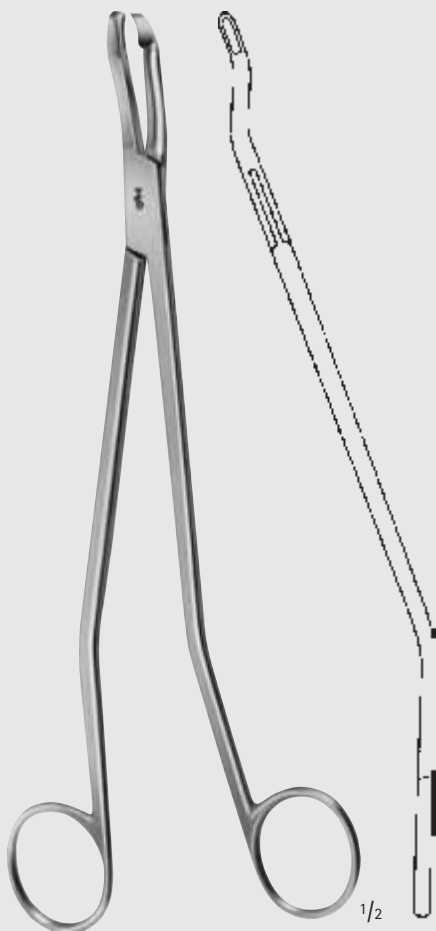

SEIDL DBP

ER072R-ER076R

Biopsiezangen, bajonettförmig,
für Portio, Vagina und Vulva

Biopsy forceps, bayonet-shaped,
for portio, vagina and vulva

240 mm, 9 1/2"

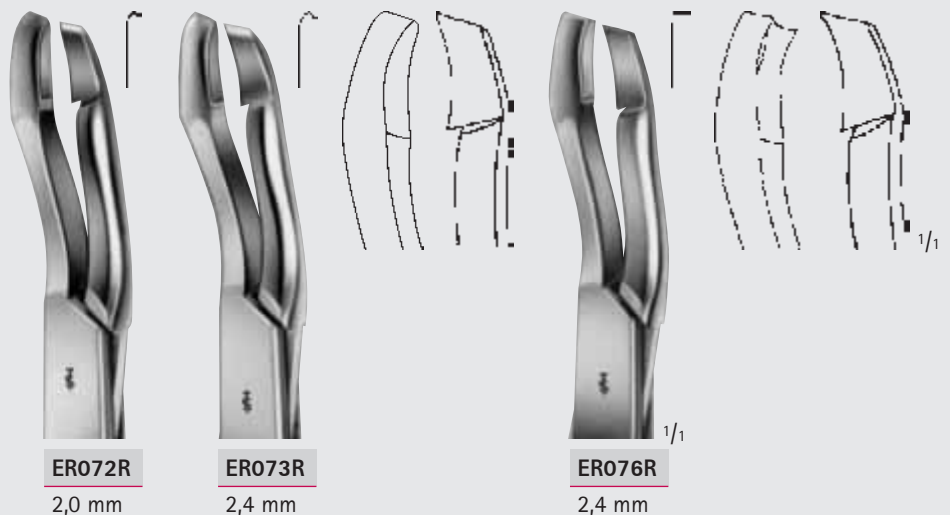

ER072R
2,0 mm

ER073R
2,4 mm

ER076R
2,4 mm

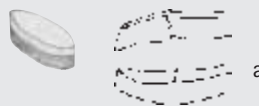

■ Es stehen zwei Maulformen zur Verfügung:

- a) Gotische Form (verursacht weniger Blutung), 2,0 bzw. 2,4 mm breit
- b) Rechteckige Form, 2,4 mm breit

■ Die glatte, senkrechte Schnittführung durch Epithel und Bindegewebe ermöglicht eine optimale histologische Untersuchung. Das PE-Stück wird seitlich auf einer planen Unterlage (z.B. Kork) fixiert und kann so "schnittgerecht" eingebettet werden. Keine tangentialen Anschnitte!

■ Durch die Bajonettbiegung bleibt die Sicht (mit oder ohne Kolposkop) auf die Portio bzw. das PE-Gebiet frei. Das Ansetzen der Zange kann gut kontrolliert werden.



■ 2 different shapes of the jaw are available:
a) gothic shape (causes less bleeding)

2.0 resp. 2.4 mm wide

b) rectangular shape, 2.4 mm wide

■ The smooth vertical cut through the epithelium and fibrous tissue allows an immediate histological examination. The biopsy is laterally fixed to a plane support (e.g. cork) and can thus properly be embedded for intersection. No tangential incisions.

■ The bayonet-shape of the forceps does neither obstruct the view to the portio nor to the area of biopsy, no matter whether a colposcope is used or not. Application of the forceps can be well controlled.



Biopsie- und Kürettage-Instrumente – Biopsy Instruments and Curettes

Biopsiezangen
Biopsy Forceps

ER

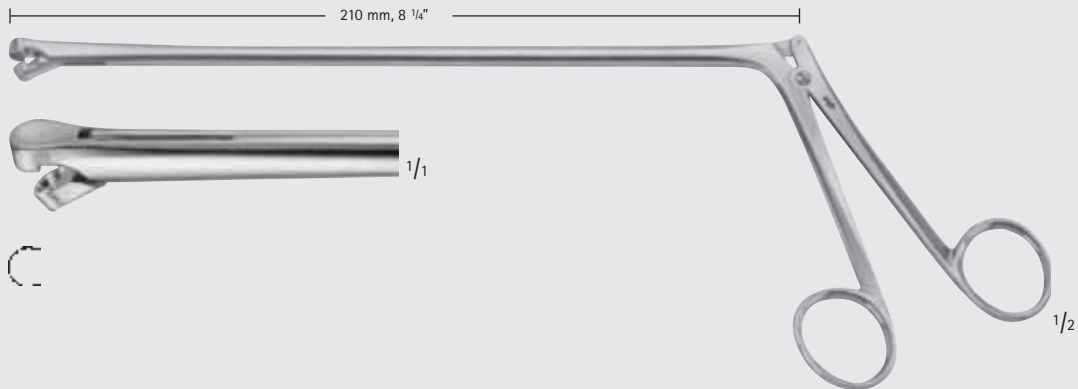

BERGER

ER066R

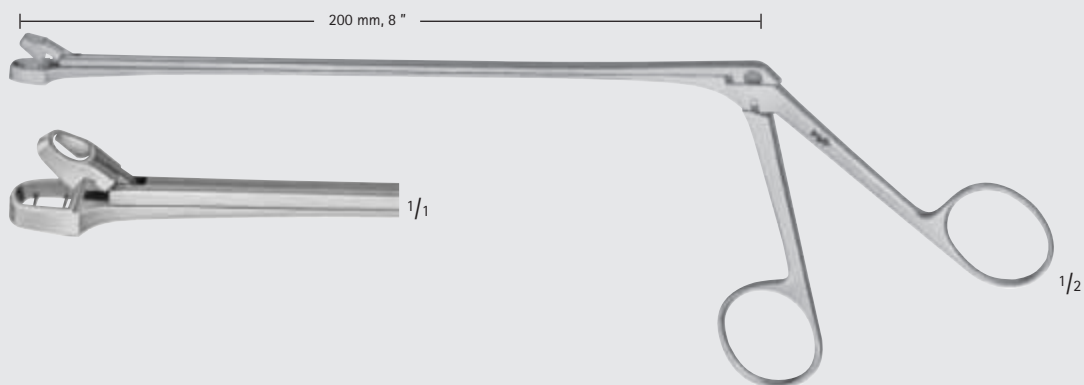

EPPENDORF

ER070R

für Kolposkopie geeignet
suitable for colposcopy

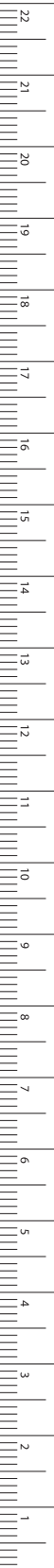

MILLIMETERS

Biopsie- und Kürettage-Instrumente – Biopsy Instruments and Currettes

Biopsiezangen

Biopsy Forceps

ER

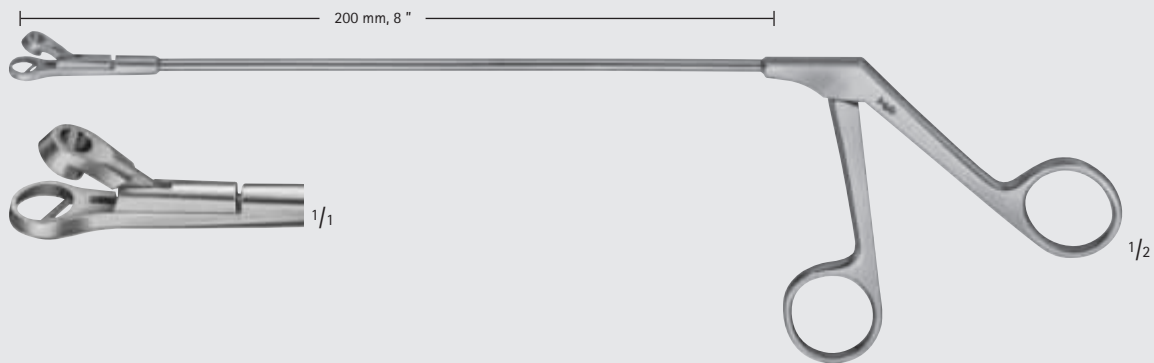

LEECH-WILKINSON

ER071R

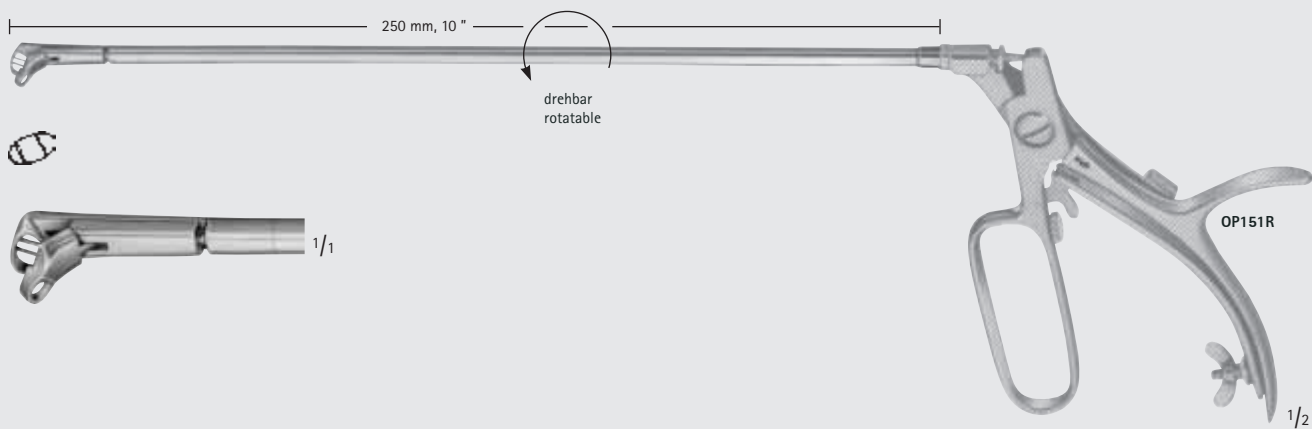

AESCULAP

EA912R

Aufsatz allein
mit ziehendem Schnitt,
passend auf Griff OP151R

Attachment only
with cut beginning from the top,
suitable for handle OP151R



Biopsie- und Kürettage-Instrumente – Biopsy Instruments and Curettes

Biopsiezangen
Biopsy Forceps

ER



AESCULAP

OP151R

Universalgriff
Universal handle
140 mm, 5 1/2"



HUBER

OP152R

Universalgriff
Universal handle
140 mm, 5 1/2"



BRÜNNINGS

OP160R 200 mm, 8"

OP161R 250 mm, 10"

Verlängerungsrohre
Extension cannula



OP222R



OP223R

KRAUSE

OP222R-OP223R

Biopsie-Aufsätze
Biopsy attachments



SCHUMACHER

OP230R

Biopsie-Aufsatz
mit ziehendem Schnitt
Biopsy attachment
with cut beginning from
the top

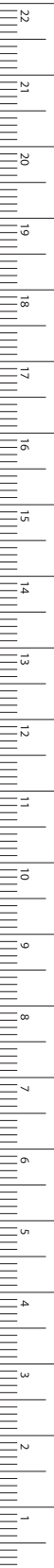

MILLIMETERS

Biopsie- und Kürettage-Instrumente – Biopsy Instruments and Curettes

Biopsiezangen

Biopsy Forceps

ER

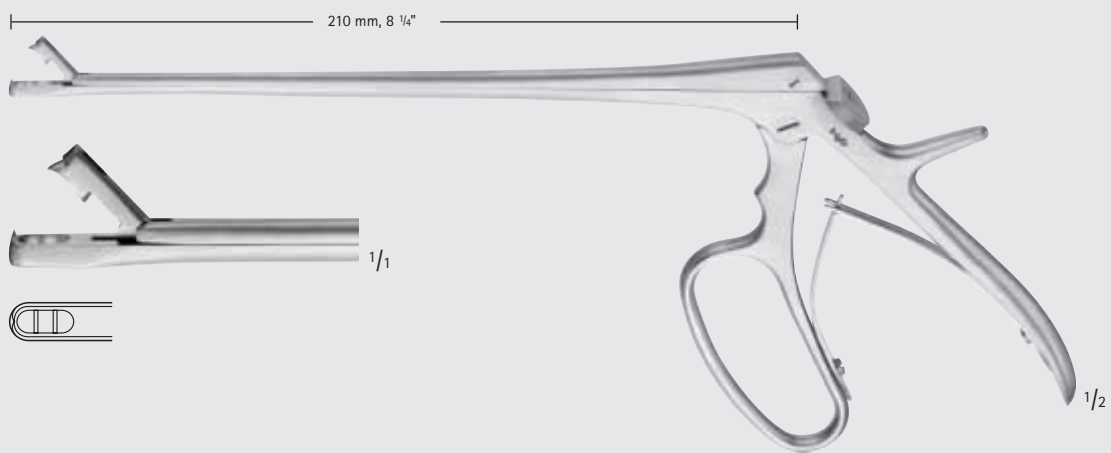

TISCHLER

ER068R



Biopsie- und Kürettage-Instrumente – Biopsy Instruments and Curettes

Uteruslöffel
Uterine Scoops

ER

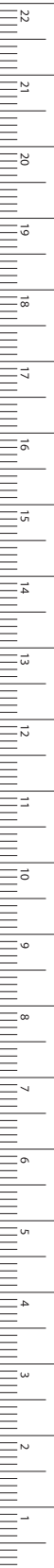

MILLIMETERS

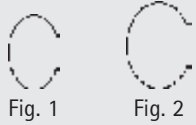

ER101R 6,8 mm
ER102R 8,5 mm

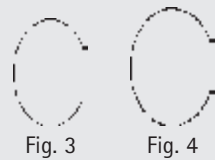

ER103R 10 mm
ER104R 11,5 mm



ER105R 13 mm
ER106R 14,5 mm

SIMON

ER101R-ER106R
max. 240 mm, 9 1/2"

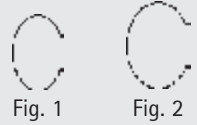

ER111R 6,8 mm
ER112R 8,5 mm



ER113R 10 mm
ER114R 11,5 mm



ER115R 13 mm
ER116R 14,5 mm

SCHRÖDER

ER111R-ER116R
max. 310 mm, 12 3/8"



ER126R 6 mm
ER128R 8 mm



ER130R 10 mm
ER132R 12 mm



ER134R 14 mm

GOURDET

ER126R-ER134R
stumpf
blunt
280 mm, 11"

Biopsie- und Kürettage-Instrumente – Biopsy Instruments and Curettes

Uterusküretten

Uterine Curettes

ER



RECAMIER

ER219R-ER230R

scharf-fest
sharp-rigid

ER241R-ER248R

scharf-biegsam
sharp-malleable

ER320R-ER330R

stumpf-fest
blunt-rigid
max. 300 mm, 12"

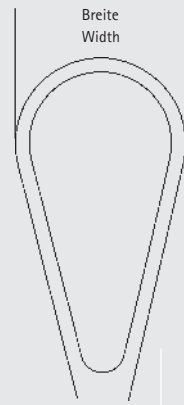
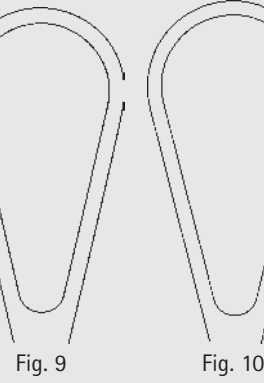
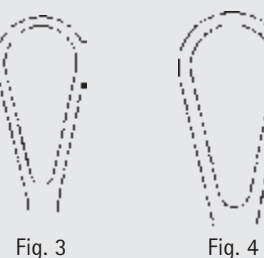
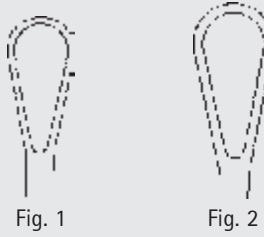
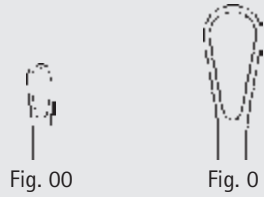

Fig.	Breite Width	scharf sharp		stumpf blunt
		fest rigid	biegsam malleable	fest rigid
00	4,5 mm	ER219R		
0	7,5 mm	ER220R		ER320R
1	8,5 mm	ER221R	ER241R	ER321R
2	10,5 mm	ER222R	ER242R	ER322R
3	12,0 mm	ER223R	ER243R	ER323R
4	14,0 mm	ER224R	ER244R	ER324R
5	15,0 mm	ER225R	ER245R	ER325R
6	16,5 mm	ER226R	ER246R	ER326R
7	18,0 mm	ER227R	ER247R	ER327R
8	19,5 mm	ER228R	ER248R	ER328R
9	21,5 mm	ER229R		ER329R
10	23,5 mm	ER230R		ER330R



Biopsie- und Kürettage-Instrumente – Biopsy Instruments and Curettes

Uterusküretten
Uterine Curettes

ER

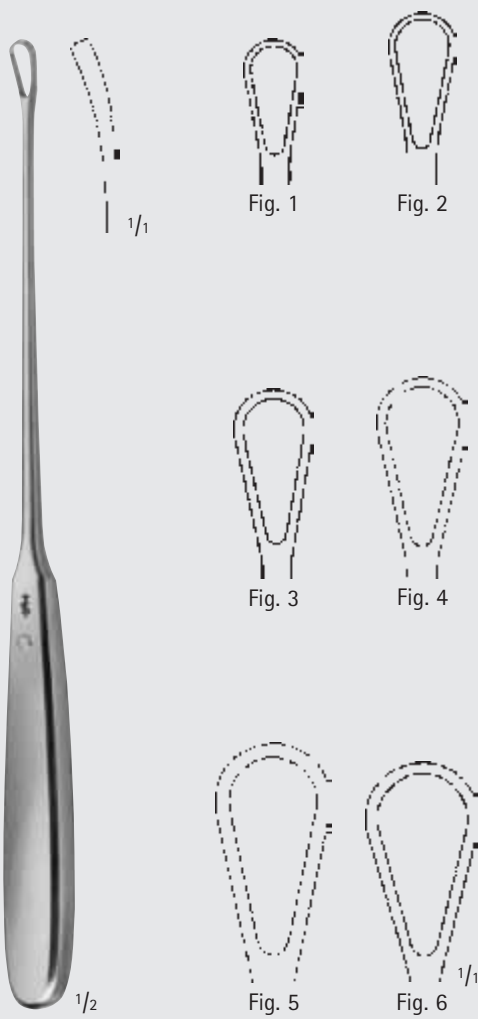

SIMS

ER401R-ER406R

scharf-fest
sharp-rigid

ER411R-ER416R

scharf-biegsam
sharp-malleable
max. 255 mm, 10"

ER421R-ER426R

stumpf-fest
blunt-rigid

Fig.	Breite Width	scharf sharp		stumpf blunt
		fest rigid	biegsam malleable	fest rigid
1	7,5 mm	ER401R	ER411R	ER421R
2	8,5 mm	ER402R	ER412R	ER422R
3	10,5 mm	ER403R	ER413R	ER423R
4	12,0 mm	ER404R	ER414R	ER424R
5	14,0 mm	ER405R	ER415R	ER425R
6	15,0 mm	ER406R	ER416R	ER426R

MILLIMETERS

Biopsie- und Kürettage-Instrumente – Biopsy Instruments and Curettes

Uterusküretten

Uterine Curettes

ER



BUMM

ER520R-ER526R

stumpf-biegsam

blunt-malleable

max . 290 mm, 11 1/2"



Fig. 0



Fig. 1



Fig. 2

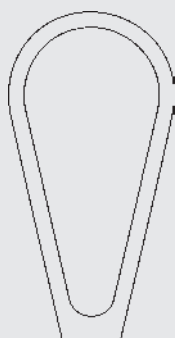

Fig. 3

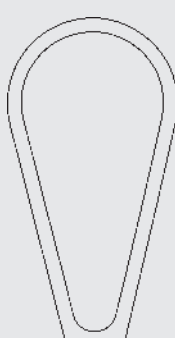

Fig. 4



Fig. 5



Fig. 6

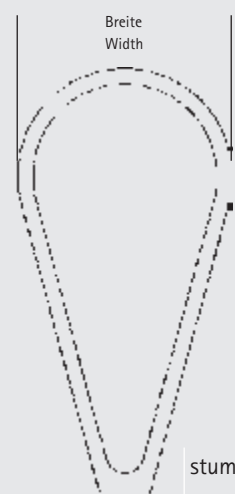

Fig.	Breite Width	stumpf blunt	biegsam malleable
0	16,0 mm	ER520R	
1	18,0 mm	ER521R	
2	19,5 mm	ER522R	
3	21,5 mm	ER523R	
4	23,5 mm	ER524R	
5	26,0 mm	ER525R	
6	28,5 mm	ER526R	



Biopsie- und Kürettage-Instrumente – Biopsy Instruments and Currettes

Uterusküretten, Plazentar- und Abortusküretten

Uterine Currettes, Placenta- and Ovum Currettes

ER



BLAKE

ER585R

275 mm, 10 3/4"



COLLIN

ER580R

300 mm, 12"



HEANEY

ER025R

240 mm, 9 5/8"

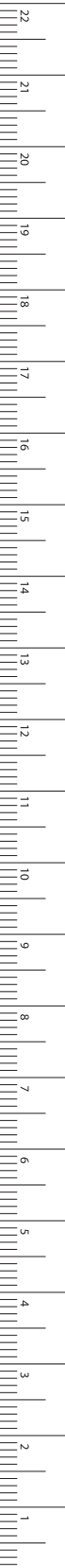

MILLIMETERS

Biopsie- und Kürettage-Instrumente – Biopsy Instruments and Curettes

Plazentar- und Abortuslöffel

Placenta- and Ovum Scoop

ER

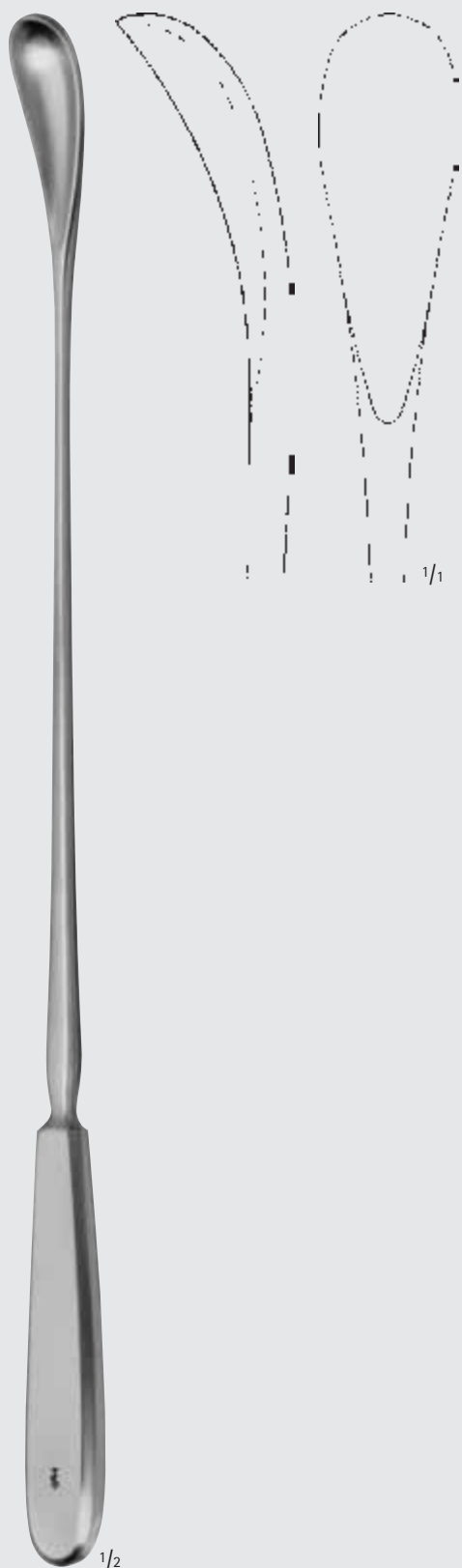

WALLICH

ER602R

420 mm, 16 3/4"



Biopsie- und Kürettage-Instrumente – Biopsy Instruments and Curettes

Plazentar- und Abortusküretten

Placenta- and Ovum Curettes

ER

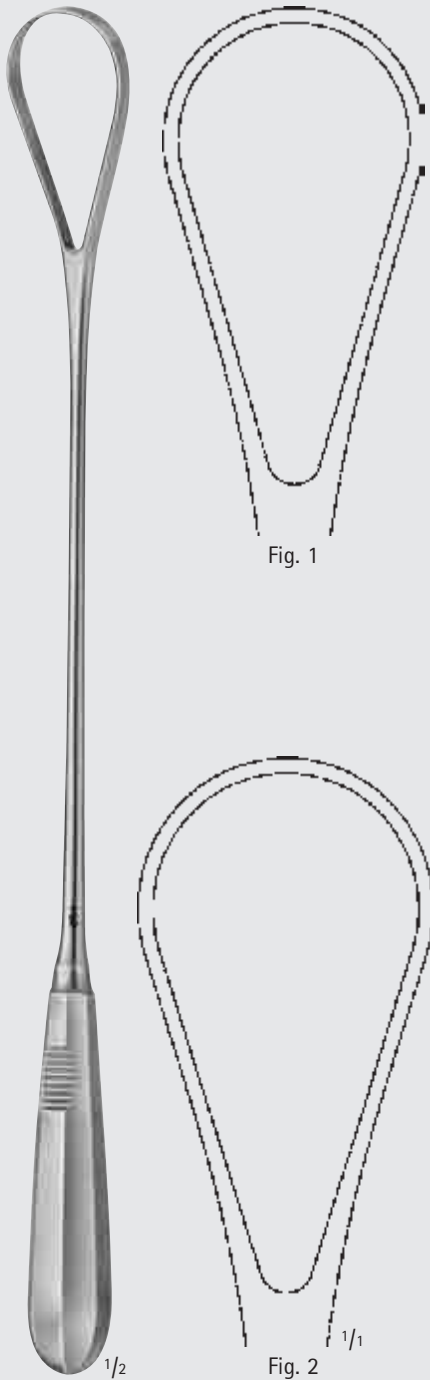

RECAMIER

ER611R-ER612R

stumpf-fest
blunt-rigid
max. 360 mm, 14 3/8"

Fig.	Breite Width	fest rigid	stumpf blunt
1	34,5 mm	ER611R	
2	39,5 mm	ER612R	

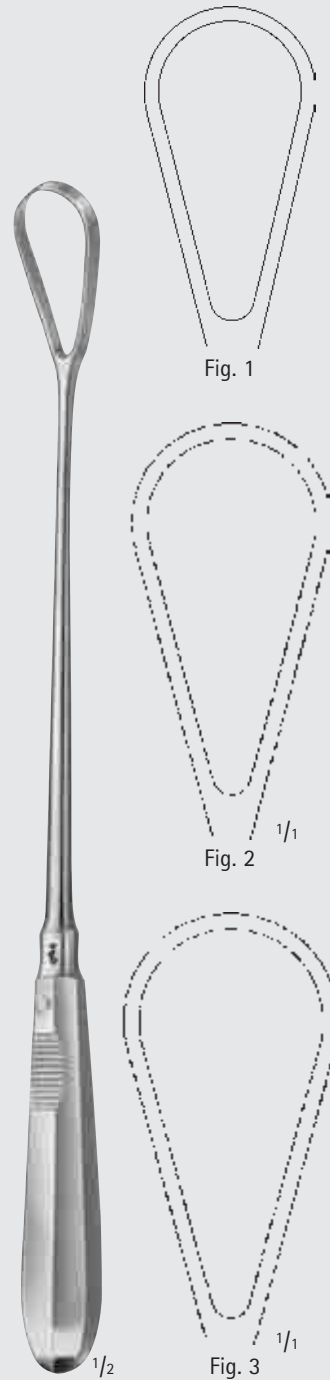

BUMM

ER621R-ER623R

scharf-biegsam
sharp-malleable

ER626R-ER628R

stumpf-biegsam
blunt-malleable
max. 310 mm, 12 3/8"

Fig.	Breite Width	scharf sharp	stumpf blunt
1	23,5 mm	ER621R	ER626R
2	26,0 mm		ER627R
3	28,5 mm	ER623R	ER628R



MILLIMETERS

Biopsie- und Kürettage-Instrumente – Biopsy Instruments and Curettes

Vakuümküretten

Vacuum Curettes

Kanülen zur Vakuümkürettage mit Graduierung und Saugunterbrecher, passend auf den Schlauchansatz GF720R. Arbeitstenden sorgfältig verrundet, daher keine Perforationsgefahr.

Curettes with graduation and suction interrupter, for vacuum curettage, fitting hose connection GF720R. Working tips are smoothly rounded off, therefore no danger of perforation.



Ø
diam.
4 mm (zur Saugbiopsie geeignet)
(suitable for suction biopsy)

GF704R	
GF706R	6 mm
GF708R	8 mm
GF710R	10 mm
GF712R	12 mm
GF714R	14 mm

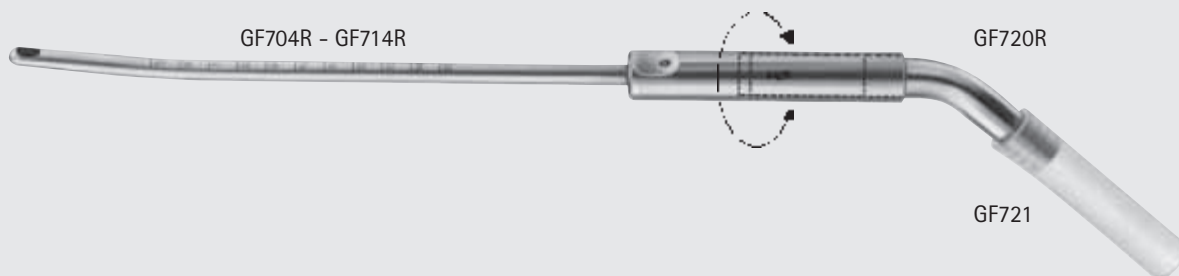

GF704R - GF714R

GF720R

GF721



GF720R

Schlauchansatz, gebogen
Innen-Ø: 11 mm
Hose connection, curved
inside diam.: 11 mm



GF721

Saugschlauch, transparent, 1,8 m lang, Innen-Ø 11 mm, Außen-Ø 16,5 mm, sterilisierbar im Autoklav bei 143 °C (3 bar)

Die Verbindung zwischen Saugküretten und Schlauchansatz GF720R gewährleistet schnelles Wechseln und freies Drehen der Saugküretten auf dem Schlauchansatz.

The connection between suction curette and hose connection GF720R guarantees quick changing and free turning of the suction curettes on the hose connection.

Transparent suction hose, 1.8 m long, inside diam. 11 mm, outside diam. 16.5 mm, can be sterilized in an autoclave at 143 °C (3 bar)



GF722

Gewebe-Auffangsieb aus Kunststoff, zum Einmalgebrauch für die histopathologische Untersuchung.

Strainer for tissues, plastic, for single use only, to be used for histopathological examination.

GF722

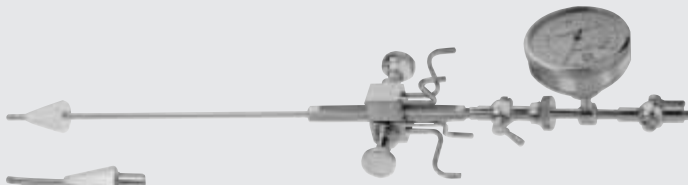
ER826C

ER827C

ER828C
SCHULZE
ER820C

Salpingograph zur Hystereo-Salpingographie, komplett bestehend aus:

- ER825C Tubenkatheter mit Hahn, ohne Kegel
- ER826C Kegel allein, klein
- ER827C Kegel allein, mittel
- ER828C Kegel allein, groß
- Manometer
- Zwischenstück
- ER829 Holzetui

Salpingograph, for utero-salpingography, complete consisting of:

- ER825 C Uterine cannula with tap without cone
- ER826C Cone only, small
- ER827C Cone only, medium
- ER828C Cone only, large
- Manometer
- Connection
- ER829 Wooden case

SCHULZE
ER822C

Salpingograph, Ausstattung wie ER820C, jedoch ohne Manometer

Salpingograph, equipment like ER820C, but without manometer

Biopsie- und Kürettage-Instrumente – Biopsy Instruments and Curettes

Uterus-Kanülen

Uterine Cannulae

ER



$\frac{1}{2}$

LEECH-WILKINSON

ER871R-ER873R

265 mm, 10 $\frac{1}{2}$ "

ER871R

klein

small

Ø 10 x 25 mm

diam. 10 x 25 mm

ER872R

mittel

medium

Ø 13 x 30 mm

diam. 13 x 30 mm

ER873R

groß

large

Ø 16 x 30 mm

diam. 16 x 30 mm

$\frac{1}{1}$



$\frac{1}{2}$

SPACKMAN

ER874R

mit Befestigungsplatte für
Hakenzange verstellbar

with adjustable plate for
vulsellum forceps

360 mm, 14 $\frac{1}{4}$ "

Biopsie- und Kürettage-Instrumente – Biopsy Instruments and Curettes

Uterus-Kanülen, Spülkatheter
Uterine Cannulae, Irrigation Catheter

ER



BEHRMAN

ER875

Uterus-Kanüle
mit abnehmbarem Konus
Uterine cannula
with detachable cone
305 mm, 12"



ER876

Uterus-Kanüle
mit Federmechanismus, selbsthaltend,
komplett mit 2 auswechselbaren Koni
groß und klein
Uterine cannula
with spring connector, self-retaining,
complete with 2 interchangeable cones
large and small
250 mm, 13"



ROTUNDA

ER867R

Spülkatheter
Ø 5 mm
Irrigation cannula
diam. 5 mm
200 mm, 8"

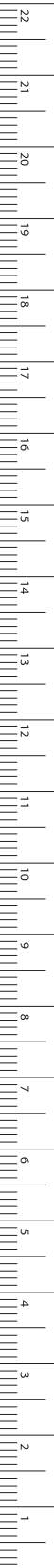

MILLIMETERS



INCHES



ET

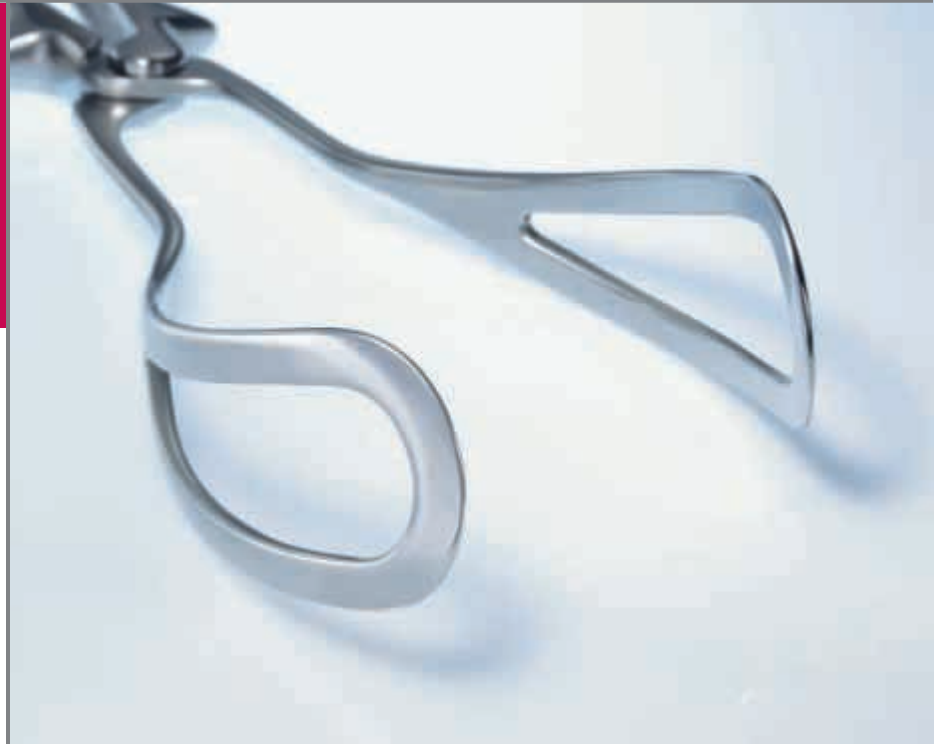

Geburtshilfe
Obstetrics

Geburtshilfe – Obstetrics

Beckenzirkel

Pelvimeters



DE LEE

ET005R

Beckenzirkel mit Zentimeter- und Zolleinteilung für innere Messungen zwischen Symphyse und Promontorium

Pelvimeter graduated in centimeters and inches for interior measurements between symphysis and promontory

$\frac{1}{2}$



MARTIN

ET073R

mit Zentimereinteilung graduated in centimeters

$\frac{1}{3}$



SCHMELZ

ET002

Rechenscheibe
Gestation calculator

$\frac{1}{3}$

Nach Applikation der Führungshülse am Injektionsort wird die Kanüle (mit aufgesetzter Spritze) durch den Trichter bzw. durch die Hülse hindurchgeführt und ins Gewebe eingestochen. Verletzungen der Vagina werden dabei vermieden. Die Einstichtiefe ist auf ca. 10 mm begrenzt. Ein Daumenring sowie eine kleine Stütze für Zeige- oder Mittelfinger dienen zur besseren Handhabung. Der Daumenring ist auf der Führungshülse verschiebbar und kann mit einer Rändelmutter – für jede Hand passend – fixiert werden. Die Fingerstütze läßt sich um die Führungshülse drehen und ermöglicht dadurch die Verwendung sowohl für Rechts- als auch für Linkshänder. Außerdem kann die Fingerstütze – evtl. bei der Pudendusnästhesie – ganz aus dem Aktionsbereich heraus in Richtung Daumenring geschoben werden.

When the guide sheath is introduced at the spot to be injected the needle (mounted on the syringe) is passed through the guide sheath and the tissue is finally injected. Injuries of the vagina are thus avoided. Depth of puncture is limited to 10 mm. Thumb ring as well as a small support for middle- or forefinger facilitate the handling. Thumb ring slides on the guide sheath and can be fixed by a knurled nut to any size of the hand. The finger support can be turned round on the guide sheath so left-handers can use it, too. Completely away from the range of actions is the finger support when it is moved towards the thumb ring, e.g. for anesthesia of the pudendus.



ET096R

Führungshülse
Guide sheath
175 mm, 7"

SR580R

Injektionskanüle Luer-Lock
Injection needle Luer-Lock hub
1,0 x 185 mm

Spezialbesteck zur transvaginalen
Injektion bei Paracervical-und
Pudendusnästhesie

Special set for transvaginal injection
for paracervical anesthesia as well
as anesthesia of the pudendus

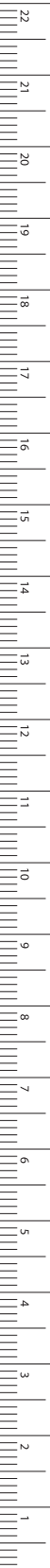

Geburtshilfe – Obstetrics

Amniotom, Blasensprenger

Amniotome, Membrane Puncturing Forceps

Stethoskope für die Geburtshilfe siehe Rubrik AC

Obstetrical stethoscopes see section AC



BEACHAM

ET102R

Amniotom

Amniotome

240 mm, 9 1/2"

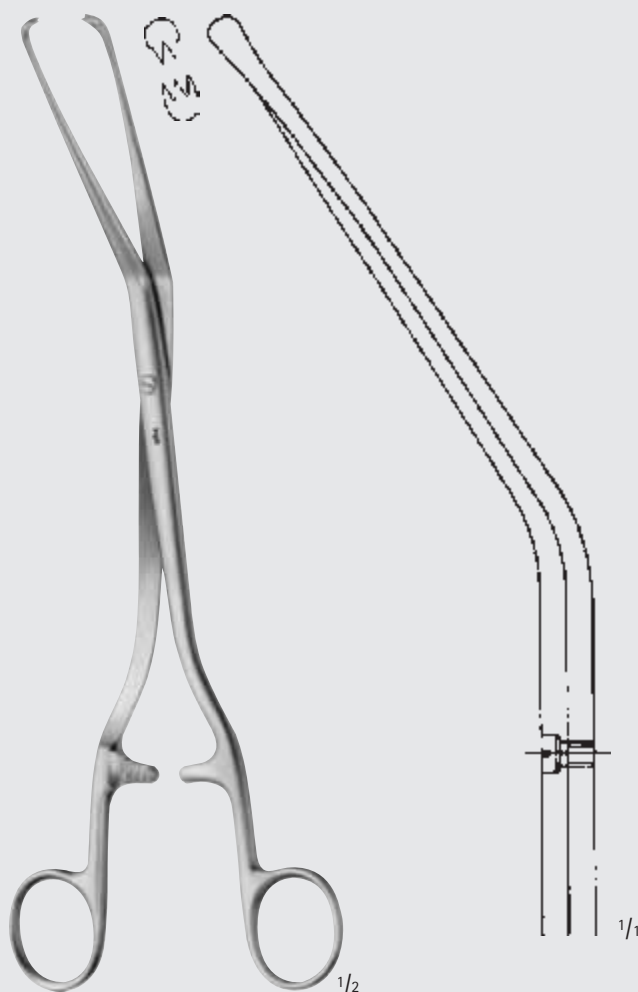

HERFF

ET106R

Blasensprenger

Membrane puncturing forceps

255 mm, 10"

ET





Geburtshilfe – Obstetrics
 Nabelschnurscheren
 Umbilical Cord Scissors

ET

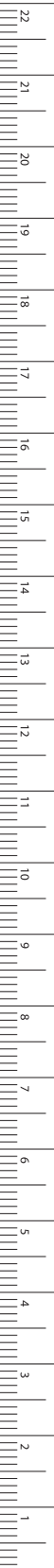

MILLIMETERS



SCHUHMACHER

ET150R

Nabelschnurschere
 Umbilical cord scissors
 155 mm, 6"

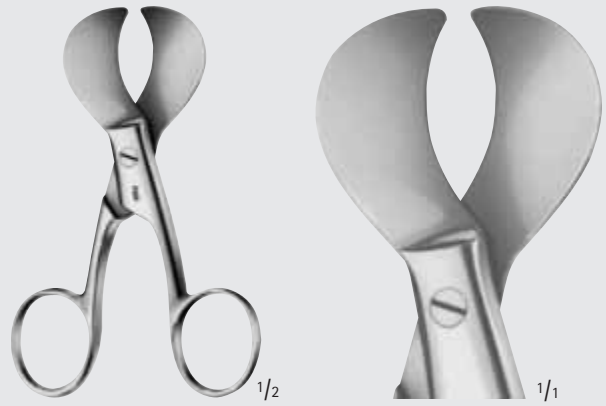

ET152R

Nabelschnurschere
 Umbilical cord scissors
 105 mm, 4 1/8"

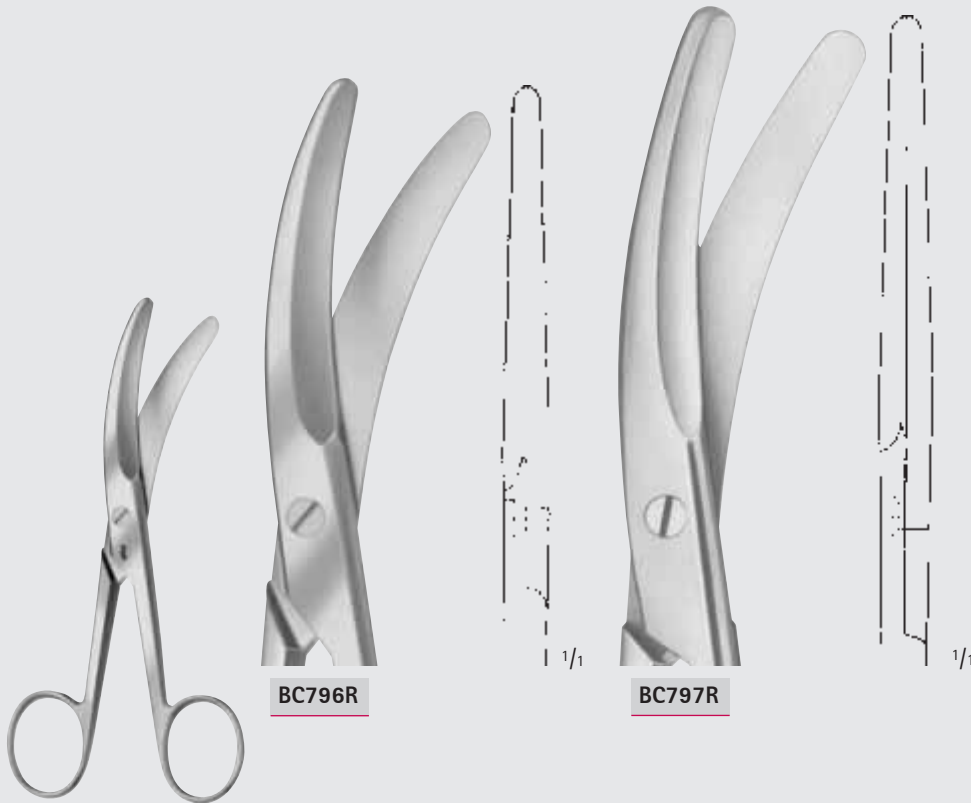

BC796R

BC797R

BC796R	135 mm	5 1/4"
BC797R	160 mm	6 1/4"

Nabelschnurscheren
 Umbilical cord scissors

Geburtshilfe – Obstetrics

Dammscheren, Nabelschnurdilatator, Nabelschnurklemme
 Episiotomy Scissors, Umbilical Dilator, Umbilical Cord Clamp



BRAUN-STADLER

ET140R 145 mm 5 3/4"

ET141R 200 mm 8"

Dammscheren

Episiotomy scissors



ET140R

1/1

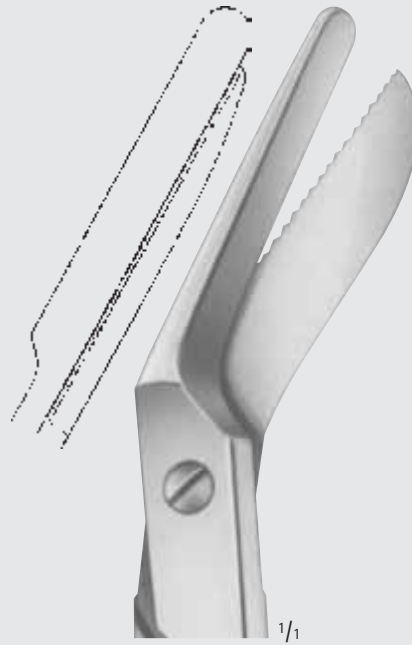

ET141R

1/1



ET142R

Dammschere
 Episiotomy scissors
 240 mm, 9 1/2"

1/2



1/1

ET130R

Nabelschnurdilatator
 Umbilical dilator
 95 mm, 3 3/4"



1/2

COLLIN

ET160R

Nabelschnurklemme
 Umbilical cord clamp
 85 mm, 3 3/8"



Geburtshilfe – Obstetrics

Vakuum-Extraktion bei der Geburtshilfe

Vacuum Extraction for Obstetrics

13

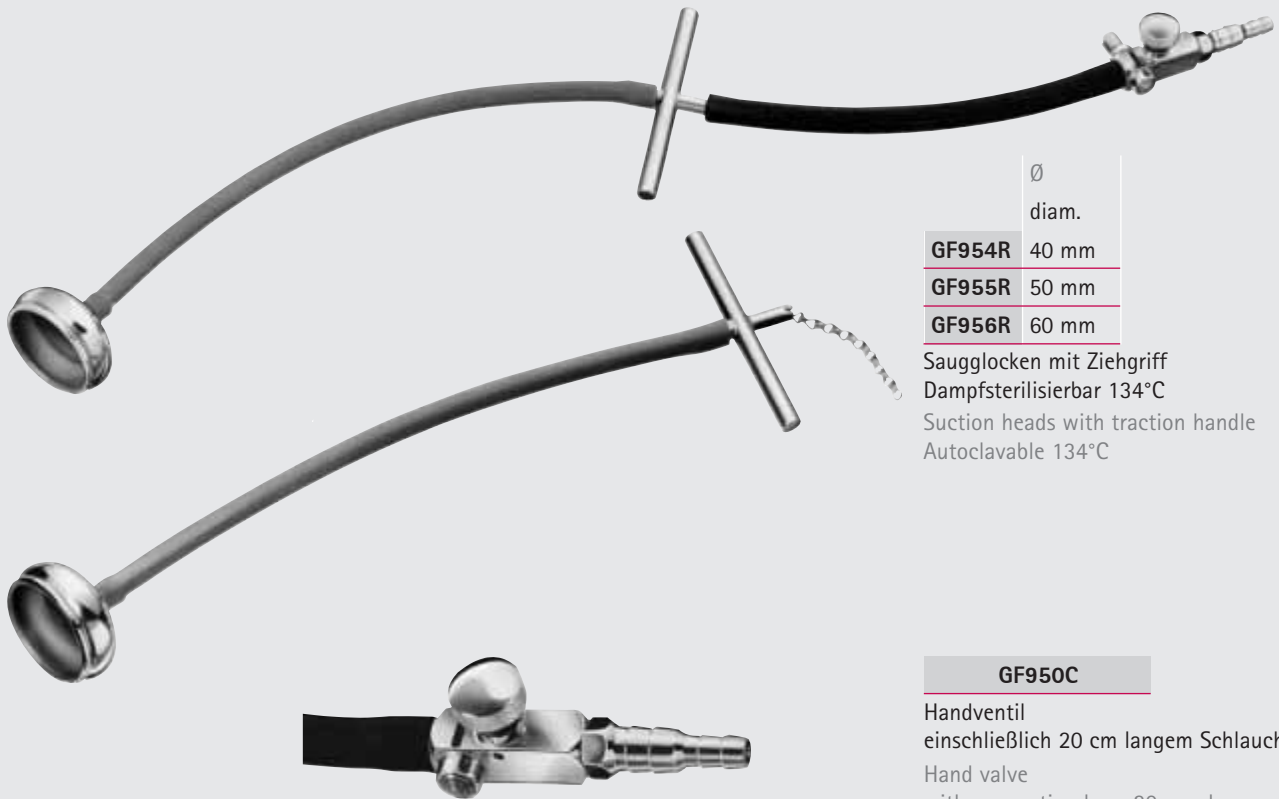

	Ø diam.
GF954R	40 mm
GF955R	50 mm
GF956R	60 mm

Sauglocken mit Ziehgriff
Dampfsterilisierbar 134°C
Suction heads with traction handle
Autoclavable 134°C

GF950C

Handventil
einschließlich 20 cm langem Schlauch
Hand valve
with connection hose 20 cms long

Mit dem Handventil GF950C können die Aesculap-Sauger auch zur Vakuum-Extraktion nach Malmström verwendet werden. Das Vakuum-Handventil GF950C ist auch an zentrale Sauganlagen anschließbar.

With the hand valve GF950C Aesculap electric suction pumps can also be used for Malmström vacuum extraction. The vacuum hand valve GF950C can also be connected to central suction system.

Funktionsweise: Das benötigte Vakuum ist durch die Regulierschraube beliebig voreinstellbar und veränderbar und besteht bis zum geschlossenen Stoppschieber. Sobald man den Stoppschieber öffnet, d.h. von links nach rechts drückt, wird die aufgesetzte Saugglocke unmittelbar unter das eingestellte Vakuum gesetzt. Zum sofortigen Absetzen der Saugglocke braucht der Stoppschieber nur geschlossen zu werden, wodurch das Vakuum der Saugglocke spontan zusammenbricht, während das Vakuum in der Saugflasche voll erhalten bleibt und nicht immer wieder zeitraubend neu aufgebaut werden muß.

Function: The vacuum required can be constantly preset by the adjusting screw. This vacuum exists then up to the closed quick-shutter, thus the vacuum in the suction head is pressed from the left to the right, the mounted suction head is immediately put under the preset vacuum. In case the preset vacuum has to be changed, this can be done with the adjusting screw. For immediate removal of the suction head simply close the quick-shutter, thus the vacuum in the suction head is eliminated at once whereas the vacuum in the suction jar remains unchanged.



GF957

Saugglocke aus Silicon-Gummi, Ø 60 mm,
mit 1,5 m Siliconschlauch
Dampfsterilisierbar 134°C
Suction head, made of silicone, 60 mm diam.,
with silicone tube 1.5 m long
Autoclavable 134°C



MILLIMETERS

Geburtshilfe – Obstetrics

Geburtszangen

Obstetrical Forceps

ET

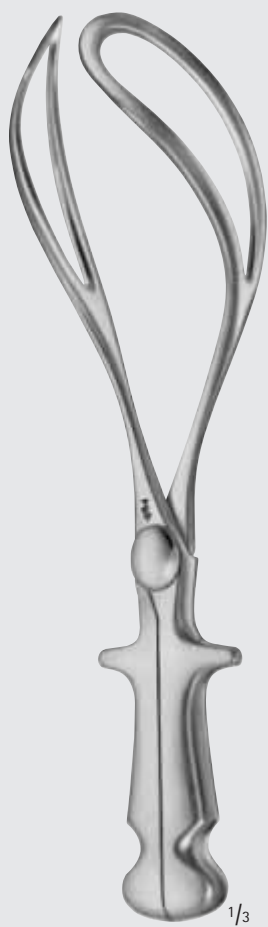

NÄGELE

ET205R

355 mm, 14 ¹/₈"



KIELLAND

ET210R

420 mm, 16 ³/₄"



SIMPSON-BRAUN

ET220R

305 mm, 12"



SIMPSON-BRAUN

ET221R

350 mm, 14"



PIPER

ET237R

für nachkommenden
Kopf bei Steißblagen
for delivery of the after
coming head in breech
presentation
445 mm, 17 1/2"

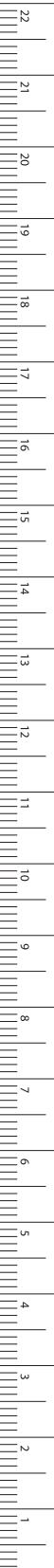

MILLIMETERS

Geburtshilfe – Obstetrics

Geburtszangen

Obstetrical Forceps

ET



SIMPSON

ET245R

für sectio caesarea
(Schnittentbindung)
for caesarean section
235 mm, 9 1/4"



WRIGLEY

ET246R

für sectio caesarea
(Schnittentbindung)
for caesarean section
250 mm, 10"



Geburtshilfe – Obstetrics
Geburtszangen
Obsterical Forceps

ET



TARNIER

ET251R

mit Achsenzugvorrichtung
with traction rod
400 mm, 16"



BARNES-NEVILLE

ET255R

mit Zugvorrichtung
with traction handle
435 mm, 17"

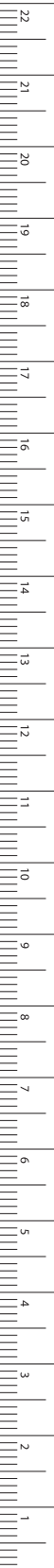

Geburtshilfe – Obstetrics

Geburtslöffel, Uterus-Klemmzange

Obstetrics Lever, Caesarean Section Hemostatic Forceps

ET



SELLHEIM

ET270R

Geburtslöffel
Obstetric lever
300 mm, 12"

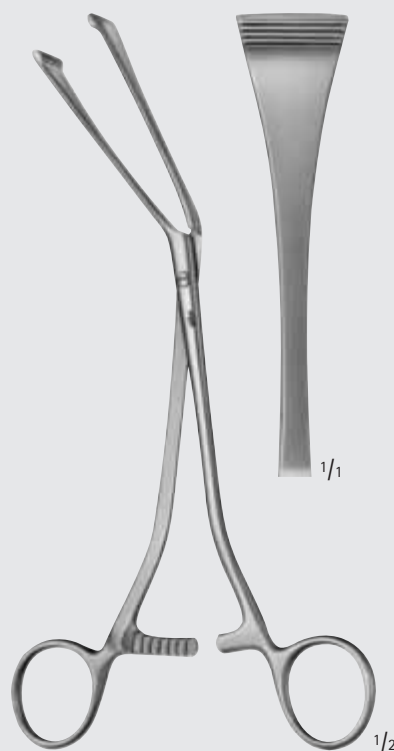

GREEN-ARMYTAGE

ET268R

Uterus-Klemmzange, abgewinkelt,
zur Blutstillung an den Schnitt-
rändern im unteren Segment bei
Kaiserschnitt-Entbindungen
Caesarean section hemostatic
forceps, angled,
for edges of the transverse
incision in the lower segment
195 mm, 7 3/4"



Geburtshilfe – Obstetrics

Uterus-Klemmzange, Kopfschwartenzange
Caesarean Hemostasis Forceps, Scalp Flap Forceps

ET



GREEN-ARMYTAGE

ET269R

Uterus-Klemmzange zur Blutstillung an den Schnittträndern im unteren Segment bei Kaiserschnitt-Entbindungen

Caesarean section haemostatic forceps, for edges of the transverse incision in the lower segment

220 mm, 8 ³/₄"

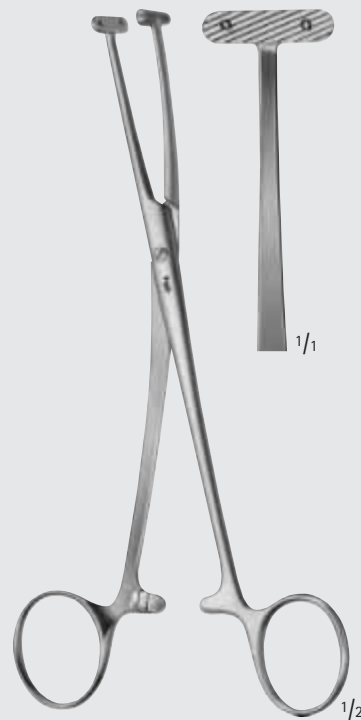

WILLETT

FF011R

Kopfschwartenzange

Scalp flap forceps

185 mm, 7 ¹/₄"

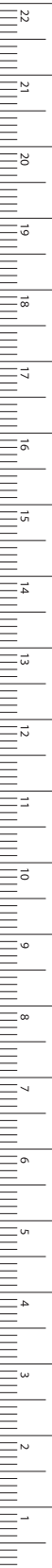

MILLIMETERS

Geburtshilfe – Obstetrics
 Plazentar- und Abortuszangen
 Placenta- and Ovum Forceps

ET



Fig. 1 Fig. 2 ^{1/1}

ET301R ET302R



Fig. 1 Fig. 2 Fig. 3 ^{1/1}

ET306R ET307R ET308R



Fig. 2 Fig. 3 ^{1/1}

ET315R ET316R



WINTER ^{1/2}

ET301R-ET302R

290 mm, 11 1/2"



WINTER ^{1/2}

ET306R-ET308R

290 mm, 11 1/2"



WINTER ^{1/2}

ET315R-ET316R

mit Sperre
 with ratchet
 290 mm, 11 1/2"



Geburtshilfe – Obstetrics
Plazentar- und Abortuszangen
Placenta- and Ovum Forceps

ET

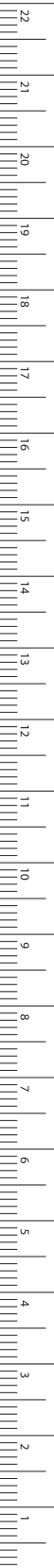

MILLIMETERS



SAENGER

ET325R

285 mm, 11 1/4"

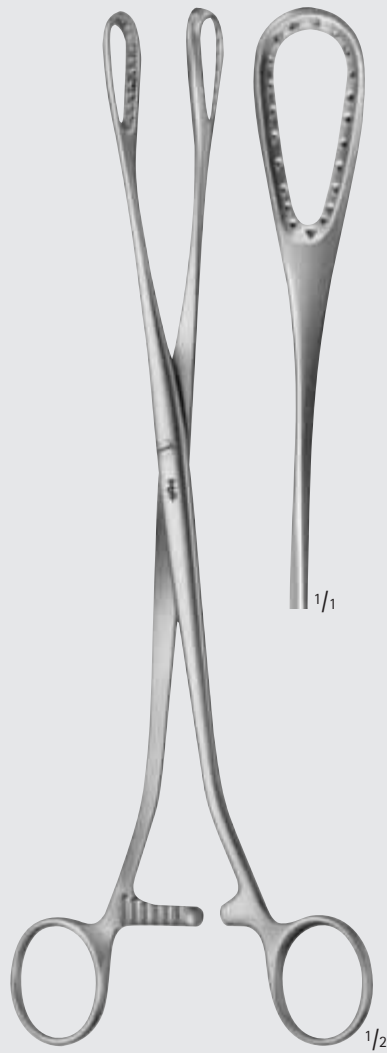

SAENGER

ET326R

275 mm, 10 3/4"

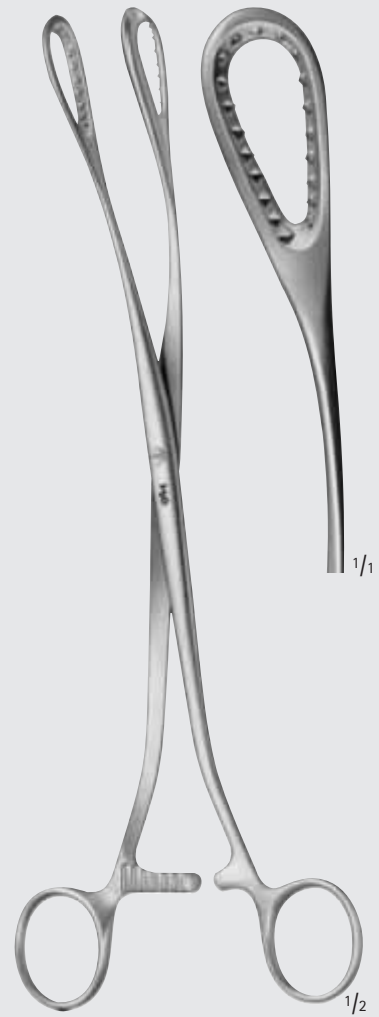

SAENGER

ET327R

265 mm, 10 1/2"

Geburtshilfe – Obstetrics
Plazentar- und Abortuszangen
Placenta- and Ovum Forceps

ET



mit Schutzklappe
with protecting cap

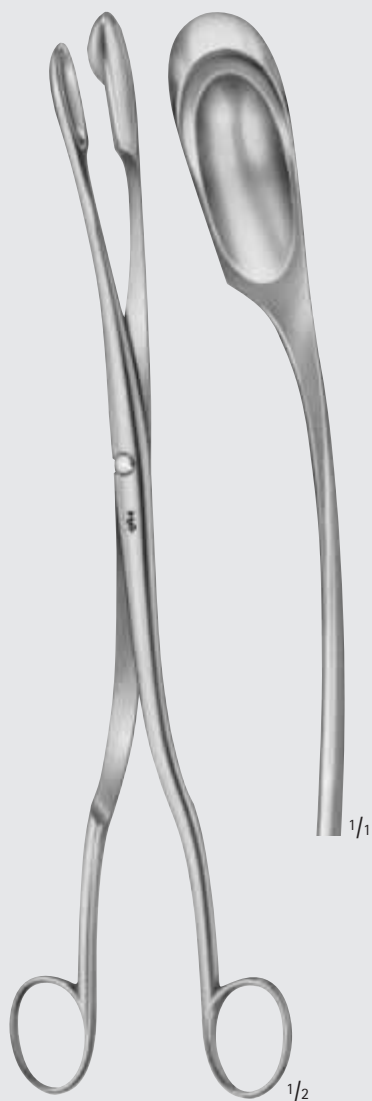

AESCULAP

ET320R

285 mm, 11 1/4"

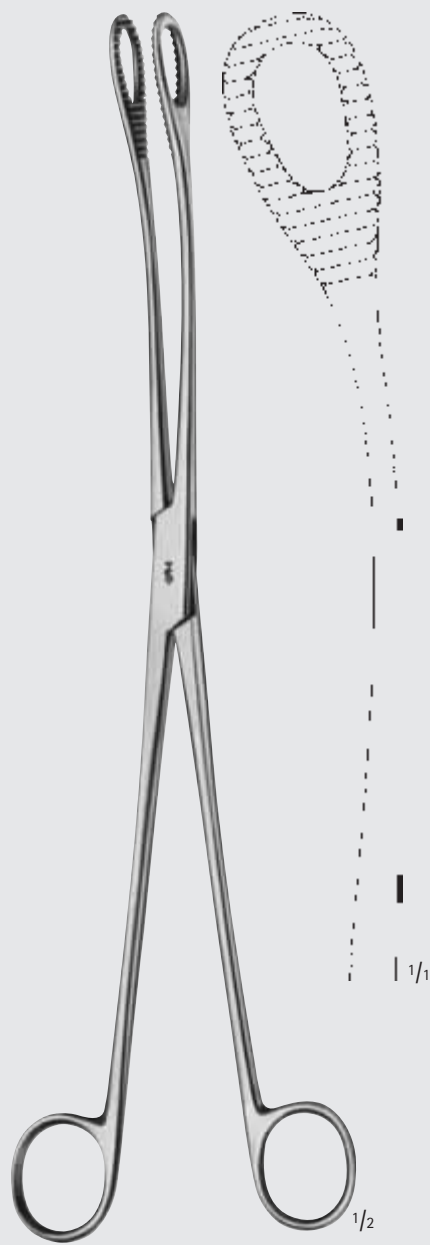

KELLY

BF135R

320 mm, 12 3/4"



Geburtshilfe – Obstetrics
Plazentar- und Abortuszangen
Plazenta- and Ovum Forceps

ET

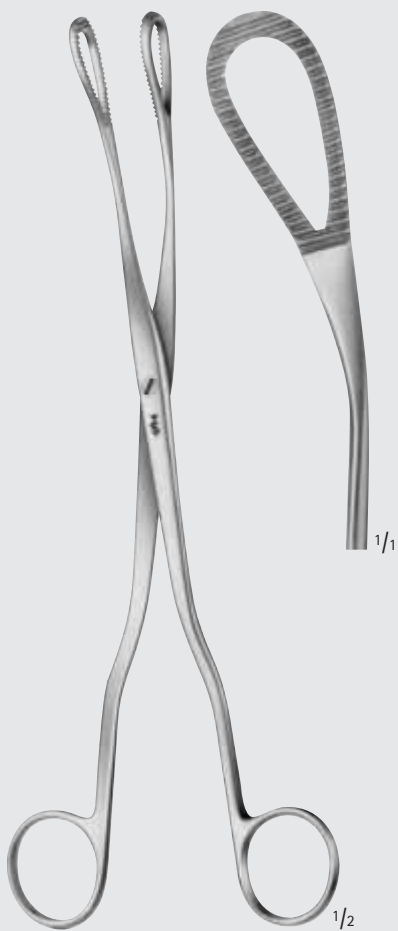

MC CLINTOCK

ET329R

240 mm, 9 1/2"

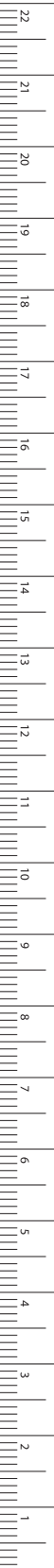

MILLIMETERS

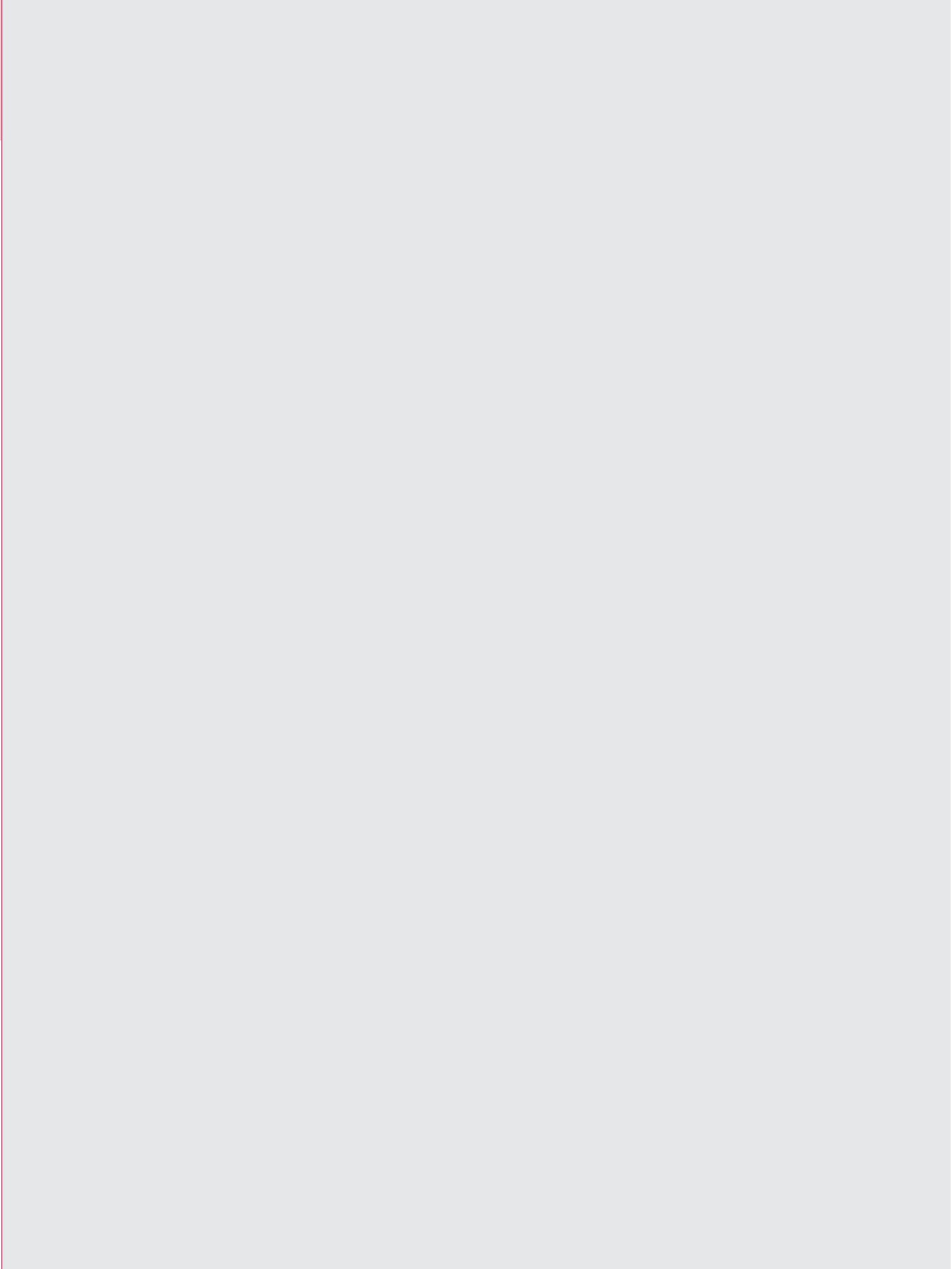



FB



Herz-, Thorax- und Gefäß-Chirurgie
Cardiovascular- and Thoracic Surgery

Herz- und Gefäß-Chirurgie – Cardiovascular Surgery

Titan Ligaturclips und Anlegezangen

Titanium Ligating Clips and Appliers

SMALL

FB

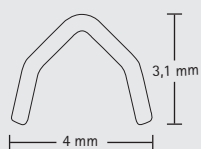

1/1

PL565T

Titan-Ligatur-Clips
small (gelb)

Bestelleinheit:

PAK = Packung à

30 Magazine = 180 Stück

Titanium ligating clips
small (yellow)

Sales unit:

PAK = Package of

30 cartridges = 180 pieces

PL566T

Cardiopack

Titan-Ligatur-Clips
small (gelb)

Bestelleinheit:

PAK = Packung à

8 Magazine = 192 Stück

Cardiopack

Titanium ligating clips

small (gelb)

Sales unit:

PAK = Package of

8 cartridges = 192 pieces



FB222R

Clipanlegezange
small (gelb)

Clip applicator

small (yellow)

150 mm, 6"



SMALL

Herz- und Gefäß-Chirurgie – Cardiovascular Surgery

Titan Ligaturclips und Anlegezangen

Titanium Ligating Clips and Appliers

FB

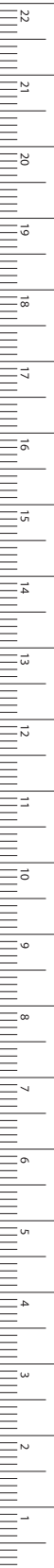

MILLIMETERS



FB223R
25°

FB226R
65°

FB224R
25°

FB227R
65°

FB223R-FB226R

Clipanlegezangen
small (gelb)
Clip appliers
small (yellow)
200 mm, 8"



FB224R-FB227R

Clipanlegezangen
small (gelb)
Clip appliers
small (yellow)
280 mm, 11"

Herz- und Gefäß-Chirurgie – Cardiovascular Surgery

Titan Ligaturclips und Anlegezangen

Titanium Ligating Clips and Appliers

MEDIUM

FB

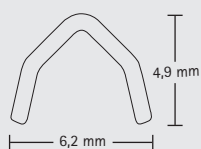

PL567T

Titan-Ligatur-Clips
medium (blau)

Bestelleinheit:

PAK = Packung à

30 Magazine = 180 Stück

Titanium ligating clips

medium (blue)

Sales unit:

PAK = Package of

30 cartridges = 180 pieces



FB234R

Clipanlegezange
medium (blau)

Clip applier
medium (blue)

150 mm, 6"



MEDIUM

Herz- und Gefäß-Chirurgie – Cardiovascular Surgery

Titan Ligaturclips und Anlegezangen
Titanium Ligating Clips and Appliers

FB

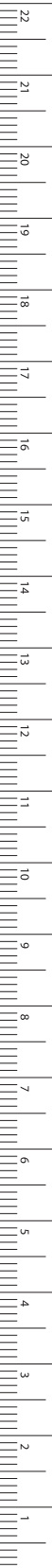

MILLIMETERS



FB235R
25°

FB238R
65°

FB235R-FB238R

Clipanlegezangen
medium (blau)

Clip appliers
medium (bleu)

200 mm, 8"



FB236R
25°

FB239R
65°

FB236R-FB239R

Clipanlegezangen
medium (blau)

Clip appliers
medium (bleu)

280 mm, 11"

Herz- und Gefäß-Chirurgie – Cardiovascular Surgery

Titan Ligaturclips und Anlegezangen

Titanium Ligating Clips and Appliers

MEDIUM-LARGE

FB

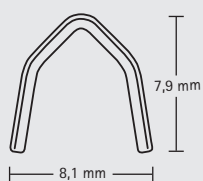

PL568T

Titan-Ligatur-Clips
medium-large (grün)
Bestelleinheit:
PAK= Packung à
20 Magazine = 120 Stück
Titanium ligating clips
medium-large (green)
Sales unit:
PAK= Package of
20 cartridges = 120 pieces



FB240R
25°

FB243R
65°

FB254R
90°
1/1

FB240R-FB254R

Clipanlegezangen
medium-large (grün)
Clip appliers
medium-large (green)
200 mm, 8"



MEDIUM-LARGE

Herz- und Gefäß-Chirurgie – Cardiovascular Surgery
Titan Ligaturclips und Anlegezangen
Titanium Ligating Clips and Appliers

FB

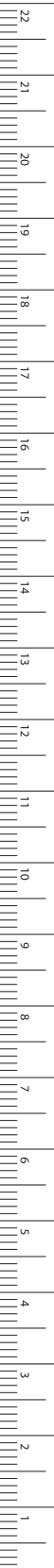

MILLIMETERS



FB242R
25°

FB245R
65°

FB255R
90°

FB242R-FB255R

Clipanlegezangen
medium-large (grün)
Clip appliers
medium-large (green)
280 mm, 11"

Herz- und Gefäß-Chirurgie – Cardiovascular Surgery

Titan Ligaturclips und Anlegezangen

Titanium Ligating Clips and Appliers

LARGE

FB

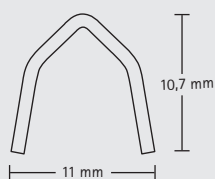

PL561T

Titan-Ligatur-Clips
large (orange)

Bestelleinheit:

PAK = Packung à

20 Magazine = 120 Stück

Titanium ligating clips

large (orange)

Sales unit:

PAK = Package of

20 cartridges = 120 pieces



FB246R-FB252R

Clipanlegezangen
large (orange)

Clip appliers

large (orange)

200 mm, 8"





LARGE

Herz- und Gefäß-Chirurgie – Cardiovascular Surgery

Titan Ligaturclips und Anlegezangen
Titanium Ligating Clips and Appliers

FB



FB248R

25°

FB251R

65°

FB253R

90°

FB248R-FB253R

Clipanlegezangen
large (orange)

Clip appliers
large (orange)

280 mm, 11"

MILLIMETERS

Herz- und Gefäß-Chirurgie – Cardiovascular Surgery

Mikro-Federschere mit Flachgriff

Micro Scissors with Flat Handle

FB



1/1

165 mm, 6 1/2"



Herz- und Gefäß-Chirurgie – Cardiovascular Surgery

Mikro-Federscheren mit Flachgriff

Micro Scissors with Flat Handle

25°



FM470R

45°



FM471R

60°



FM472R

90°



FM473R

125°



FM474R

1/1

gerade
straight

aufgebogen
curved
on flat

Feines Blatt
Fine blade



FM451R



FM452R



FM453R



FM454R



FM455R

1/1

Feines Blatt,
1 Blatt mit Knopf
Fine blade,
with 1 probe
pointed blade



FM437R



FM438R



FM439R



FM440R



FM441R



FM442R



FM436R

1/1

Sehr feines Blatt
Delicate blade



FM431R



FM432R



FM433R



FM434R



FM435R



FM444R



FM430R

1/1

Extrem feines Blatt
Ultra delicate blade

FB

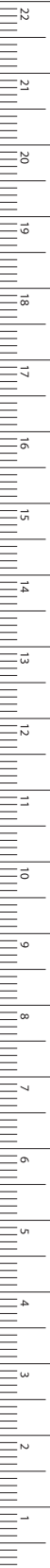

MILLIMETERS

Herz- und Gefäß-Chirurgie – Cardiovascular Surgery

Mikro-Federscheren mit Rundgriff

Micro Scissors (Spring Type) with Round Handle

FB



1/1

165 mm, 6 1/2"



Herz- und Gefäß-Chirurgie – Cardiovascular Surgery

Mikro-Federscheren mit Rundgriff Micro Scissors with Round Handle

25°



FM476R

45°



FM477R

60°



FM478R

90°



FM479R

125°



FM480R

gerade
straight

aufgebogen
curved
on flat

Feines Blatt
Fine blade



FM482R



FM483R



FM484R



FM485R



FM486R



FM488R



FM481R

Sehr feines Blatt
Delicate blade



FM489R



FM490R



FM491R



FM492R



FM493R

Sehr feines Blatt,
1 Blatt mit Knopf
Delicate blade,
with 1 probe
pointed blade



FM504R



FM505R



FM506R



FM507R



FM508R



FM503R

Extrem feines Blatt
Ultra delicate blade

FB

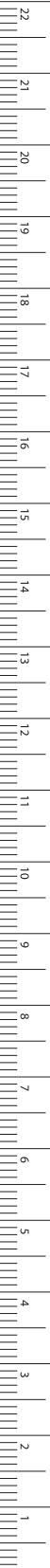

MILLIMETERS

Herz- und Gefäß-Chirurgie – Cardiovascular Surgery

Mikro-Gefäßscheren

Micro Vascular Scissors

FB



DIETHRICH-POTTS
180 mm, 7"

1/1



Herz- und Gefäß-Chirurgie – Cardiovascular Surgery

Mikro-Gefäßscheren
Micro Vascular Scissors

FB

25°



BC522R

45°

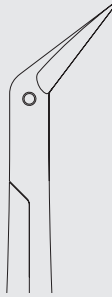

BC523R

60°

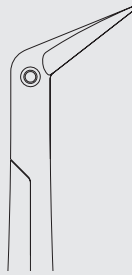

BC524R

90°

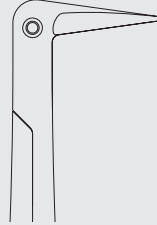

BC525R

125°

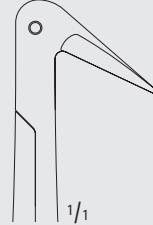

BC526R

Standard Blatt
Standard blade



BC531R

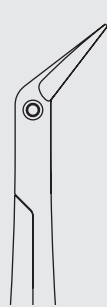

BC532R

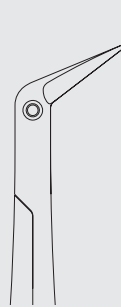

BC533R

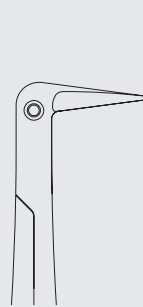

BC534R

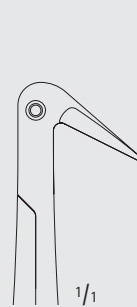

BC535R

Sehr feines Blatt
Delicate blade



BC515R

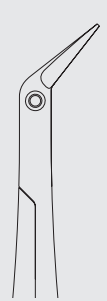

BC516R

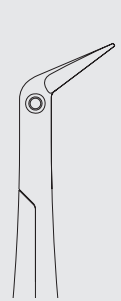

BC517R

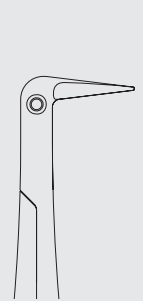

BC518R

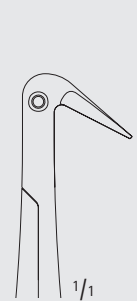

BC519R

Extrem feines Blatt
Ultra delicate blade

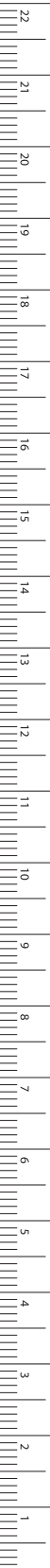

MILLIMETERS

Herz- und Gefäß-Chirurgie – Cardiovascular Surgery

Mikro-Pinzetten mit Rundgriff und Gewicht

Micro Forceps with Round Handles and Counter Balance

FB

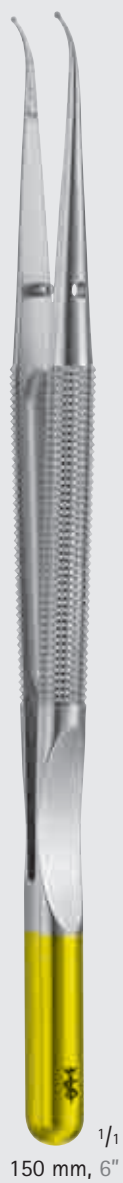

150 mm, 6" $\frac{1}{1}$

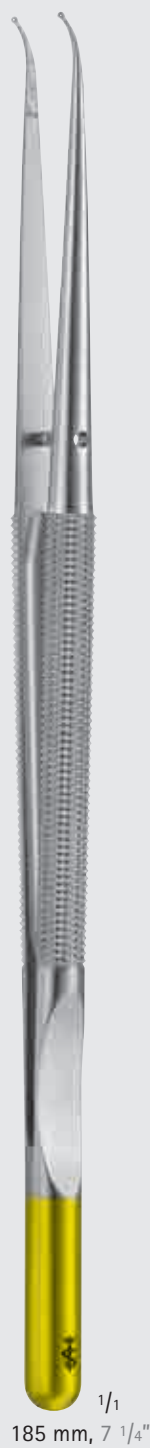

185 mm, 7 $\frac{1}{4}$ " $\frac{1}{1}$

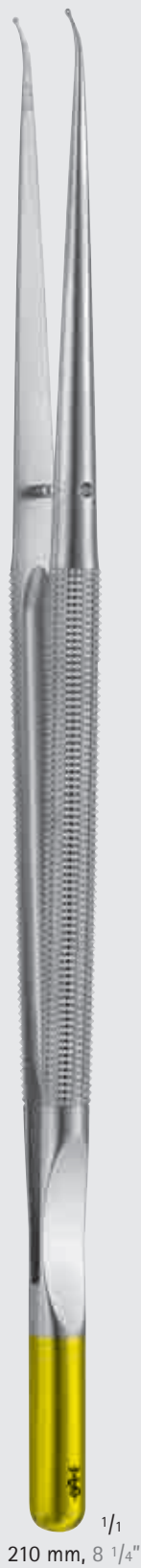

210 mm, 8 $\frac{1}{4}$ " $\frac{1}{1}$



230 mm, 9" $\frac{1}{1}$



250 mm, 10" $\frac{1}{1}$



Herz- und Gefäß-Chirurgie – Cardiovascular Surgery

Mikro-Pinzetten mit Rundgriff und Gewicht

Micro Forceps with Round Handles and Counter Balance

FB



MILLIMETERS

DIADUST



Die Diamantstaubbeschichtung sorgt für eine noch härtere und verschleißfestere Maulinnenfläche. Darüber hinaus garantiert die Struktur der DIADUST-Beschichtung ein zuverlässiges Fassen von feinen Nadeln und Nahtmaterialien sowie von Weichgewebe.

The diamond dust coating ensures an even harder and more wear resistant surface on the inside of the jaws. Moreover, the structure of the DIADUST coating guarantees a reliable grip for fine needles and sutures, as well as for tissue.

Maulform
Jaw

Ring-Ø: 1 mm, gerade diam. of ring: 1 mm, straight	Ring-Ø: 1 mm, gebogen diam. of ring: 1 mm, curved	Ring-Ø: 2 mm, gerade diam. of ring: 2 mm, straight	Fadenplatte, gerade Platform tips, straight	Fadenplatte, gebogen Platform tips, curved	1 mm, DeBakey Zahnung 1 mm, DeBakey tip
---	--	---	--	---	---



1/1

Länge (mm)
Length (in.)

150 mm 6"	FM570R	FM571R		FM578R	FM581R	
185 mm 7 1/4"	FM572R	FM573R	FM579R	FM580R	FM583R	FM592R
210 mm 8 1/4"	FM574R	FM575R		FM599R	FM585R	FM600R
230 mm 9"	FM576R	FM577R				
250 mm 10"	FM596R	FM595R		FM594R	FM593R	

Herz- und Gefäß-Chirurgie – Cardiovascular Surgery

Mikro-Pinzetten mit Rundgriff, ohne Gewicht

Micro Forceps with Round Handles, without Counter Balance

DIADUST

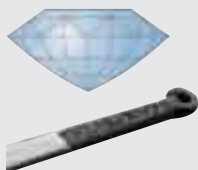

Die Diamantstaubbeschichtung sorgt für eine noch härtere und verschleißfestere Maulinnenfläche. Darüber hinaus garantiert die Struktur der DIADUST-Beschichtung ein zuverlässiges Fassen von feinen Nadeln und Nahtmaterialien sowie von Weichgewebe.

The diamond dust coating ensures an even harder and more wear resistant surface on the inside of the jaws. Moreover, the structure of the DIADUST coating guarantees a reliable grip for fine needles and sutures, as well as for tissue.



185 mm, 7 1/4"

210 mm, 8 1/4"

FB





Herz- und Gefäß-Chirurgie – Cardiovascular Surgery

Mikro-Pinzetten mit Rundgriff, ohne Gewicht

Micro Forceps with Round Handles, without Counter Balance

Maulform Jaw	Ring-Ø: 1 mm, gerade diam. of ring: 1 mm, straight	Ring-Ø: 1 mm, gebogen diam. of ring: 1 mm, curved	Ring-Ø: 1 mm mit Fadenplatte diam. of ring: 1 mm with platform tip	Fadenplatte, gerade Platform tip, straight	1 mm, DeBakey Zahnung 1 mm, DeBakey tip
Länge (mm) Length (in.)					
185 mm 7 1/4"	FM597R	FM587R	FM582R	FM586R	FM590R
210 mm 8 1/4"	FM598R	FM589R	FM584R	FM588R	FM591R

Karoprofil
cross serrated

1/1

1/2

FM063R

Rundgriff
round handle
200 mm, 8"

DIADUST

FM053R

Ring-Ø: 2,5 mm
diam. of ring: 2.5 mm

180 mm
7"

FM054R

Ring-Ø: 2,5 mm
diam. of ring: 2.5 mm

200 mm
8"

FM053R-FM054R

Rundgriff
round handle

FB

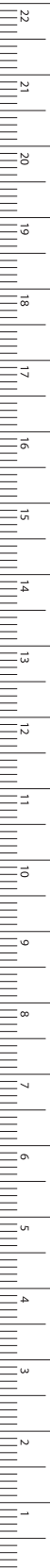

MILLIMETERS

Herz- und Gefäß-Chirurgie – Cardiovascular Surgery

Mikro-Pinzetten mit Flachgriff

Micro Forceps with Flat Handle

FB



180 mm, 7" $\frac{1}{1}$



200 mm, 8" $\frac{1}{1}$



250 mm, 10" $\frac{1}{1}$



Herz- und Gefäß-Chirurgie – Cardiovascular Surgery

Mikro-Pinzetten mit Flachgriff Micro Forceps with Flat Handle

FB

DIADUST



Die Diamantstaubbeschichtung sorgt für eine noch härtere und verschleißfestere Maulinnenfläche. Darüber hinaus garantiert die Struktur der DIADUST-Beschichtung ein zuverlässiges Fassen von feinen Nadeln und Nahtmaterialien sowie von Weichgewebe.

The diamond dust coating ensures an even harder and more wear resistant surface on the inside of the jaws. Moreover, the structure of the DIADUST coating guarantees a reliable grip for fine needles and sutures, as well as for tissue.

Maulform
Jaw

1 mm,
Karoprofil

1 mm,
cross serrated



1 mm,
DeBakey
Zahnung

1 mm,
DeBakey tip



Ring-Ø:
1 mm,
gerade

diam. of ring:
1 mm,
straight



Ring-Ø:
1 mm,
gebogen

diam. of ring:
1 mm,
curved



1 mm,
gerade

1 mm,
straight



Länge (mm)
Length (in.)

180 mm
7"

BD190R

BD191R

BD192R

BD193R

BD194R

200 mm
8"

BD195R

BD196R

250 mm
10"

BD197R

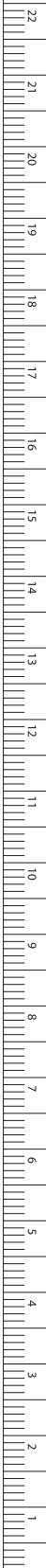

MILLIMETERS



Herz- und Gefäß-Chirurgie – Cardiovascular Surgery

DIADUST Mikro-Nadelhalter mit Rundgriff

DIADUST Micro Needle Holders with Round Handle

DIADUST



Die Diamantstaubbeschichtung sorgt für eine noch härtere und verschleißfestere Maulinnenfläche. Darüber hinaus garantiert die Struktur der DIADUST-Beschichtung ein zuverlässiges Fassen von feinen Nadeln und Nahtmaterialien sowie von Weichgewebe.

The diamond dust coating ensures an even harder and more wear resistant surface on the inside of the jaws. Moreover, the structure of the DIADUST coating guarantees a reliable grip for fine needles and sutures, as well as for tissue.

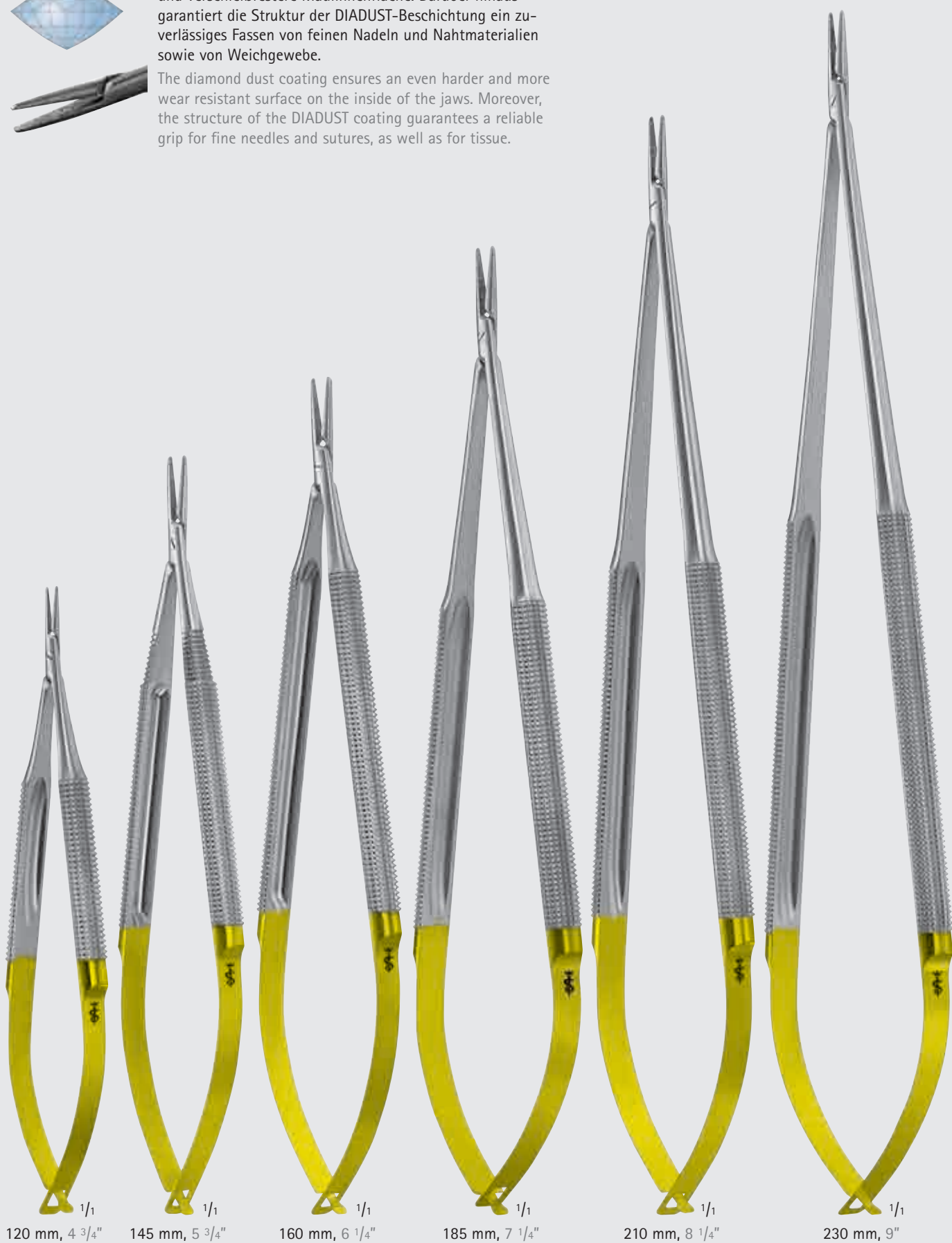

120 mm, 4 ³/₄"

145 mm, 5 ³/₄"

160 mm, 6 ¹/₄"

185 mm, 7 ¹/₄"

210 mm, 8 ¹/₄"

230 mm, 9"

1/1

1/1

1/1

1/1

1/1

1/1



DIADUST



Herz- und Gefäß-Chirurgie – Cardiovascular Surgery

DIADUST Mikro-Nadelhalter mit Rundgriff

DIADUST Micro Needle Holders with Round Handle

FB

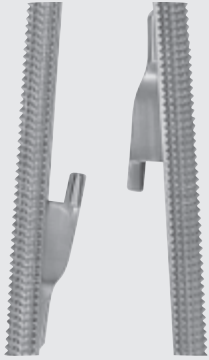

mit Sperre
with ratchet



Nahtmaterialgröße
Suture size

Länge (mm) Length (in.)	7/0 und kleiner 7/0 and smaller	5/0 und kleiner 5/0 and smaller	4/0 und kleiner 4/0 and smaller	4/0 und kleiner 4/0 and smaller
120 mm 4 3/4"	FM520R			
145 mm 5 3/4"		FM522R		
160 mm 6 1/4"	FM521R	FM523R		
185 mm 7 1/4"	FM563R	FM564R	FM218R	
210 mm 8 1/4"	FM565R	FM566R	FM228R	FM221R
230 mm 9"	FM567R	FM568R	FM230R	FM223R

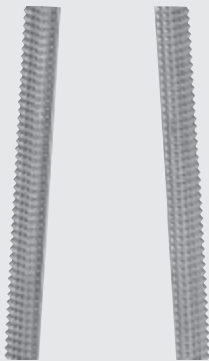

ohne Sperre
without
ratchet



Nahtmaterialgröße
Suture size

Länge (mm) Length (in.)	7/0 und kleiner 7/0 and smaller	5/0 und kleiner 5/0 and smaller
120 mm 4 3/4"	FM524R	
145 mm 5 3/4"		FM528R
160 mm 6 1/4"	FM525R	FM529R
185 mm 7 1/4"	FM526R	FM530R
210 mm 8 1/4"	FM527R	FM531R
230 mm 9"	FM532R	FM533R

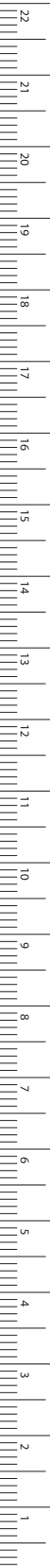

MILLIMETERS

Herz- und Gefäß-Chirurgie – Cardiovascular Surgery

DIADUST Mikro-Nadelhalter mit Rundgriff

DIADUST Micro Needle Holders with Round Handle

DIADUST



Die Diamantstaubbeschichtung sorgt für eine noch härtere und verschleißfestere Maulinnenfläche. Darüber hinaus garantiert die Struktur der DIADUST-Beschichtung ein zuverlässiges Fassen von feinen Nadeln und Nahtmaterialien sowie von Weichgewebe.

The diamond dust coating ensures an even harder and more wear resistant surface on the inside of the jaws. Moreover, the structure of the DIADUST coating guarantees a reliable grip for fine needles and sutures, as well as for tissue.



190 mm, 7 1/2"

230 mm, 9"

250 mm, 10"



DIADUST



Herz- und Gefäß-Chirurgie – Cardiovascular Surgery

DIADUST Mikro-Nadelhalter mit Rundgriff

DIADUST Micro Needle Holders with Round Handle

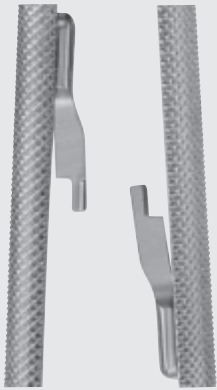

mit Sperre,
kräftige
Ausführung
with ratchet,
heavy style

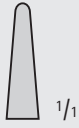

Nahtmaterialgröße
Suture size

Länge (mm)
Length (in.)

190 mm
7 1/2"

FM538R

230 mm
9"

FM539R

250 mm
10"

FM534R

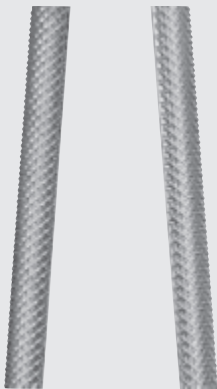

ohne Sperre,
kräftige
Ausführung
without
ratchet,
heavy style



Nahtmaterialgröße
Suture size

Länge (mm)
Length (in.)

190 mm
7 1/2"

FM535R

230 mm
9"

FM536R

250 mm
10"

FM537R

FB

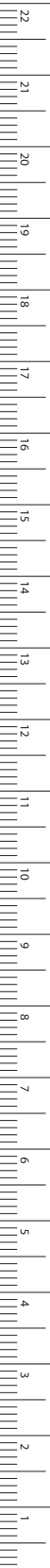

MILLIMETERS

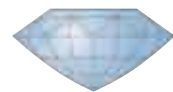

Herz- und Gefäß-Chirurgie – Cardiovascular Surgery

DIADUST Mikro-Nadelhalter mit Flachgriff

DIADUST Micro Needle Holders with Flat Handles

DIADUST



Die Diamantstaubbeschichtung sorgt für eine noch härtere und verschleißfestere Maulinnenfläche. Darüber hinaus garantiert die Struktur der DIADUST-Beschichtung ein zuverlässiges Fassen von feinen Nadeln und Nahtmaterialien sowie von Weichgewebe.

The diamond dust coating ensures an even harder and more wear resistant surface on the inside of the jaws. Moreover, the structure of the DIADUST coating guarantees a reliable grip for fine needles and sutures, as well as for tissue.



145 mm, 5 ³/₄"

170 mm, 6 ³/₄"

185 mm, 7 ¹/₄"

210 mm, 8 ¹/₄"

230 mm, 9"



DIADUST



Herz- und Gefäß-Chirurgie – Cardiovascular Surgery

DIADUST Mikro-Nadelhalter mit Flachgriff

DIADUST Micro Needle Holders with Flat Handles

FB

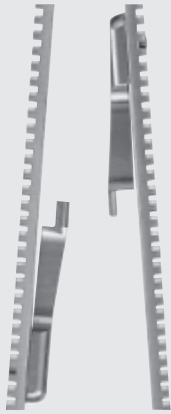

mit Sperre
with ratchet



Nahtmaterialgröße
Suture size

Länge (mm) Length (in.)	7/0 und kleiner 7/0 and smaller	5/0 und kleiner 5/0 and smaller
145 mm 5 3/4"		FM541R
170 mm 6 3/4"	FM540R	
185 mm 7 1/4"		FM542R
210 mm 8 1/4"		FM543R
230 mm 9"		FM544R

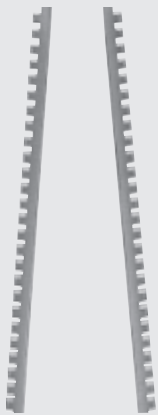

ohne Sperre
without
ratchet



Nahtmaterialgröße
Suture size

Länge (mm) Length (in.)	7/0 und kleiner 7/0 and smaller	5/0 und kleiner 5/0 and smaller
145 mm 5 3/4"		FM546R
170 mm 6 3/4"	FM545R	
185 mm 7 1/4"		FM547R
210 mm 8 1/4"		FM548R
230 mm 9"		FM549R

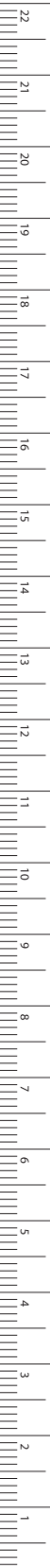

MILLIMETERS

Herz- und Gefäß-Chirurgie – Cardiovascular Surgery

DIADUST Mikro-Nadelhalter mit Flachgriff

DIADUST Micro Needle Holder with Flat Knurled Handle

DIADUST



DIADUST



Die Diamantstaubbeschichtung sorgt für eine noch härtere und verschleißfestere Maulinnenfläche. Darüber hinaus garantiert die Struktur der DIADUST-Beschichtung ein zuverlässiges Fassen von feinen Nadeln und Nahtmaterialien sowie von Weichgewebe.

The diamond dust coating ensures an even harder and more wear resistant surface on the inside of the jaws. Moreover, the structure of the DIADUST coating guarantees a reliable grip for fine needles and sutures, as well as for tissue.



185 mm, 7 1/4"

210 mm, 8 1/4"

230 mm, 9"

FB





DIADUST



Herz- und Gefäß-Chirurgie – Cardiovascular Surgery

DIADUST Mikro-Nadelhalter mit Flachgriff

DIADUST Micro Needle Holders with Flat Knurled Handle



mit Sperre
with ratchet



Nahtmaterialgröße
Suture size

Länge (mm)
Length (in.)

5/0 und kleiner
5/0 and smaller

185 mm
7 1/4"

FM550R

210 mm
8 1/4"

FM551R

230 mm
9"

FM552R



ohne Sperre
without
ratchet



Nahtmaterialgröße
Suture size

Länge (mm)
Length (in.)

5/0 und kleiner
5/0 and smaller

185 mm
7 1/4"

FM553R

210 mm
8 1/4"

FM554R

230 mm
9"

FM555R

FB

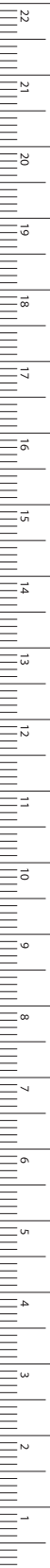

MILLIMETERS

Herz- und Gefäß-Chirurgie – Cardiovascular Surgery

DIADUST Mikro-Nadelhalter

DIADUST Micro Needle Holders

DIADUST

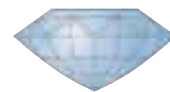

DIADUST



Die Diamantstaubbeschichtung sorgt für eine noch härtere und verschleißfestere Maulinnenfläche. Darüber hinaus garantiert die Struktur der DIADUST-Beschichtung ein zuverlässiges Fassen von feinen Nadeln und Nahtmaterialien sowie von Weichgewebe.

The diamond dust coating ensures an even harder and more wear resistant surface on the inside of the jaws. Moreover, the structure of the DIADUST coating guarantees a reliable grip for fine needles and sutures, as well as for tissue.



GLASSER

FM560R

Nahtmaterialgröße: 5/0 und kleiner
Suture size: 5/0 and smaller
125 mm, 5"



GLASSER

FM561R

Nahtmaterialgröße: 5/0 und kleiner
Suture size: 5/0 and smaller
180 mm, 7"



DIADUST



Herz- und Gefäß-Chirurgie – Cardiovascular Surgery

DIADUST Mikro-Nadelhalter
DIADUST Micro Needle Holders

FB

FM236R
mit Sperre
Nahtmaterialgröße: 5/0 und kleiner
with ratchet
Suture size: 5/0 and smaller
210 mm, 8 1/4"

1/1

1/2

FM276R
ohne Sperre
Nahtmaterialgröße: 5/0 und kleiner
without ratchet
Suture size: 5/0 and smaller
210 mm, 8 1/4"

1/1

1/2

BM301R	BM325R	BM302R	BM327R	BM328R
140 mm	160 mm	180 mm	220 mm	250 mm
5 1/2"	6 1/4"	7"	8 3/4"	10"

RYDER
BM301R-BM328R
Nahtmaterialgröße: 5/0 und kleiner
Suture Size: 5/0 and smaller



MILLIMETERS

Herz- und Gefäß-Chirurgie – Cardiovascular Surgery

Spezialinstrumentarium für die Anlage von AV-Shunts bei Dialysepatienten

Instruments for Shunt Operations

Die Shunt Instrumente wurden speziell für Operationen an Gefäßen mit einem Durchmesser zwischen 4 und 6 mm entwickelt.

Besonders häufig tritt dieser Gefäßdurchmesser bei der Anlage oder Revision Dialysehunts auf. Bei den vorliegenden Instrumenten handelt es sich um eine Synthese von konventionellen Instrumenten und Mikroinstrumenten. Die Arbeitsenden wurden entsprechend dem Gefäßdurchmesser etwas größer gewählt, das Griffdesign entspricht einem Mikroinstrument um eine bessere Handhabung zu ermöglichen.

The shunt instruments were developed especially for operations on vessels that are between 4 and 6 mm in diameter.

This width is frequently found in dialysis shunt operations and re-operations. These instruments combine the features of conventional instruments and micro instruments. The working tips are larger than usual for instruments of this type, and the micro instrument style handles make the instruments better to use.

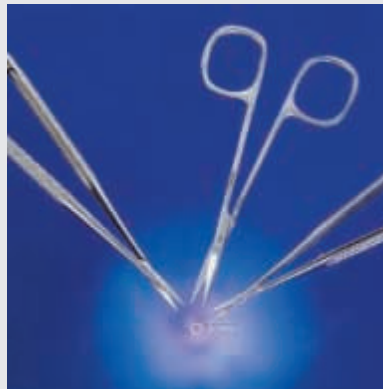

Entwickelt in Zusammenarbeit mit Prof. Dr. med. Gottfried Müller Caritas Krankenhaus Bad Mergentheim Uhlandstrasse 7 97980 Bad Mergentheim

The shunt set was developed in cooperation with Prof. Dr. med. Gottfried Müller, M.D. Caritas Krankenhaus Bad Mergentheim Uhlandstrasse 7 97980 Bad Mergentheim

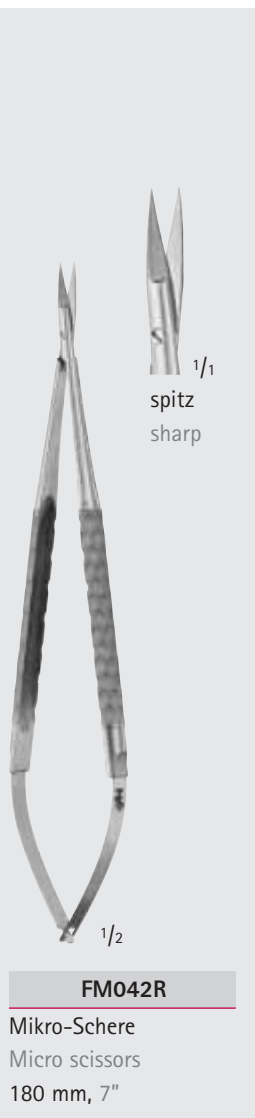



FB





Herz- und Gefäß-Chirurgie – Cardiovascular Surgery



Spezialinstrumentarium für die Anlage von AV-Shunts bei Dialysepatienten Instruments for Shunt Operations

1/1
Ring-Ø: 2 mm
diam. of ring: 2 mm

FM047R
Mikro-Ringpinzette
Micro ring forceps
180 mm, 7"

1/2

DIADUST

1/1
Ring-Ø: 1 mm
diam. of ring: 1 mm

FM572R
Mikro-Ringpinzette
Micro ring forceps
185 mm, 7 1/4"

1/2



DIADUST

2/1

FD255R
Chirurgische Mikro-Pinzette
Micro tissue forceps
180 mm, 7"

1/2







DIADUST

1/1
mit Plateau
with platform tip

FD253R
Anatomische Mikro-Pinzette
Micro dissecting forceps
180 mm, 7"

1/2

DIADUST

FD258R **FD259R**

1/1

FD258R-FD259R
Mikro-Nadelhalter
Micro needle holders
180 mm, 7"

1/2

FB

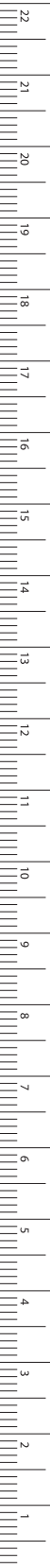

MILLIMETERS

Herz- und Gefäß-Chirurgie – Cardiovascular Surgery

Mikro-Nadelhalter mit Flachgriff

Micro Needle Holders with Flat Handles

FB



BM563R

BM564R

1/2

CASTROVIEJO

BM563R-BM564R

mit Sperre
with catch

145 mm, 5 3/4"

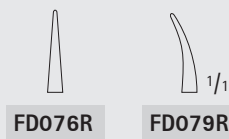

FD076R

FD079R

1/2

FD076R-FD079R

ohne Sperre
without catch

160 mm, 6 1/4"



FD080R

FD081R

1/2

FD080R-FD081R

ohne Sperre
without catch

185 mm, 7 1/4"



FD045R

FD046R

ohne Sperre
without catch

mit Sperre
with catch

1/2

JACOBSON

FD045R-FD046R

185 mm, 7 1/4"

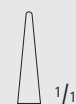

1/1

1/2

FD048R

mit Sperre
with catch

200 mm, 8"



Herz- und Gefäß-Chirurgie – Cardiovascular Surgery

Mikro-Nadelhalter mit Rundgriffen

Micro Needle Holders with Round Handles

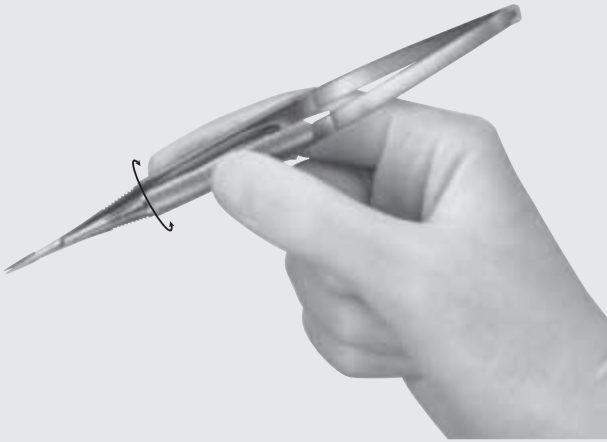

... mit Rundgriffen

- Rundgriffe erlauben Drehbewegungen zwischen den Fingern.
- Optimale Balance, individuell je nach Instrument, durch volle oder gehöhlte Griffpartien.

... with round handles

- Round handles allow turning manipulations between the fingers.
- Optimum balance individually for each instrument due to solid or hollowed-out handles.

FB

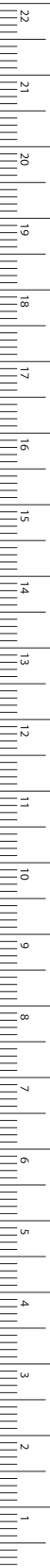

MM/MILLIMETERS



BARRAQUER

BM560R-BM562R

ohne Sperre
without catch

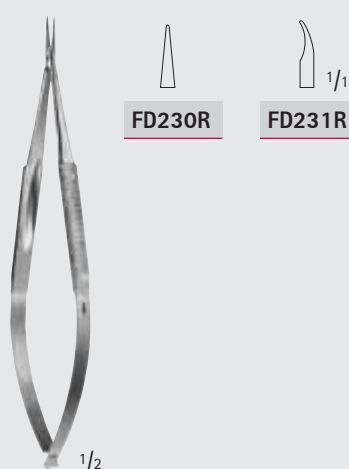

BARRAQUER

FD230R-FD231R

ohne Sperre
without catch
120 mm, 4 3/4"

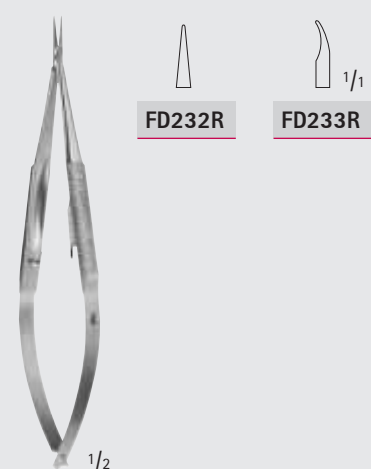

BARRAQUER

FD232R-FD233R

mit Sperre
with catch
120 mm, 4 3/4"

Herz- und Gefäß-Chirurgie – Cardiovascular Surgery

Mikro-Nadelhalter mit Rundgriffen

Micro Needle Holders with Round Handles

FB



FD240R

FD241R

1/2

REILL

FD240R-FD241R

ohne Sperre
without catch
150 mm, 6"

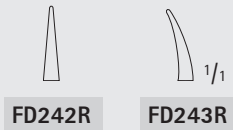

FD242R

FD243R

1/2

FD242R-FD243R

mit Sperre
with catch
150 mm, 6"

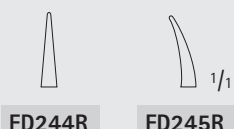

FD244R

FD245R

1/2

FD244R-FD245R

ohne Sperre
without catch
185 mm, 7 1/4"



FD246R

FD247R

1/2

FD246R-FD247R

mit Sperre
with catch
185 mm, 7 1/4"



FM398R

FM392R

ohne Sperre
without catch

mit Sperre
with catch

1/2

FM398R-FM392R



Herz- und Gefäß-Chirurgie – Cardiovascular Surgery

DUROGRIP® Mikro-Nadelhalter

DUROGRIP® Micro Needle Holders

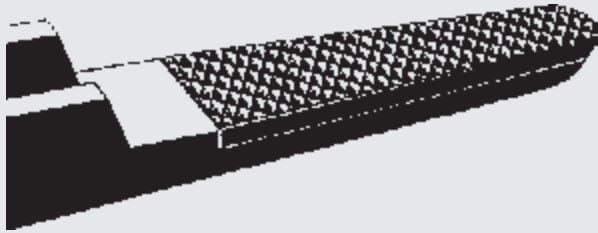
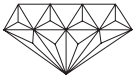

AESCULAP-Nadelhalter sind durch die Struktur der Hartmetall-Maulteile auf das jeweilige, indikationsbezogene Nahtmaterial abgestimmt. Eine glatte Maulfläche sowie 3 verschiedene Haftprofile garantieren den sicheren „Griff“ der jeweiligen Nadel.

AESCULAP needle holders have jaws with carbide inserts and according to the use required the resp. structure can be chosen. A smooth jaw surface as well as 3 different serrations guarantee a sure „grip“ of the resp. needle.



glatt
smooth



0,2



0,4



0,5

Wir empfehlen Hartmetall-Maulteile mit glatter Fläche für Nahtmaterial mit Teilung 0,2 mm für Nahtmaterial 0,4 mm 0,5 mm

9/0 – 11/0
6/0 – 10/0
4/0 – 6/0
bis 3/0

We recommend carbide inserts with smooth jaw surface for suture material with 0.2 mm pitch of serration for suture material 0.4 mm 0.5 mm

9/0 – 11/0
6/0 – 10/0
4/0 – 6/0
up to 3/0



DUROGRIP®-Nadelhalter mit Hartmetall-Plättchen

Kennzeichnung:

Vergoldete Ringe, Branchenenden und Sperren

DUROGRIP® Needle Holders with carbide inserts

Identification:

gold-plated rings, handle ends and ratchets



1/1
mit glattem Maul
with smooth jaw

1/2

CASTROVIEJO

BM001R

145 mm, 5 3/4"



1/1
0,2

1/2

CASTROVIEJO

BM002R

145 mm, 5 3/4"



1/1
0,4

1/2

BM003R

170 mm, 6 3/4"

FB

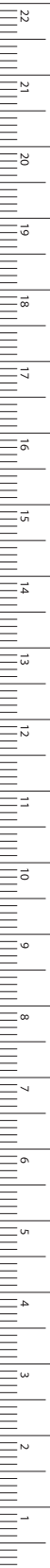

MILLIMETERS

Herz- und Gefäß-Chirurgie – Cardiovascular Surgery

DUROGRIP® Mikro-Nadelhalter

DUROGRIP® Micro Needle Holders

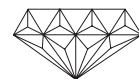

FB



CASTROVIEJO

BM004R

180 mm, 7"



CASTROVIEJO

BM005R

215 mm, 8 1/2"



FM388R

mit Sperre
with catch
180 mm, 7"



FM390R

mit Sperre
with catch
200 mm, 8"

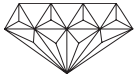

Herz- und Gefäß-Chirurgie – Cardiovascular Surgery

DUROGRIP® Nadelhalter, ergonomische Griff-Form
DUROGRIP® Nadelhalter, Ergonomic Handle

Diese Instrumente bieten dem Chirurgen ein Maximum an ergonomischem Komfort. Das optimierte Design der Instrumente ermöglicht ein ermüdungsfreies Arbeiten insbesondere bei schwierigen Naht- und Anastomostechiken.

These instruments provide the surgeon with a maximum of ergonomical comfort. The optimized design of the Instruments offers a fatigue-free working especially with regard to difficult suture and anastomosis techniques.

FB



HELLBERG-KUPKA

BM320R

mit Anreichsperre
with locking ratchet
210 mm, 8 1/4"



REIN-KUPKA

BM310R

ohne Sperre
without ratchet
190 mm, 7 1/2"



REIN-KUPKA

BM311R

mit Sperre
with ratchet
190 mm, 7 1/2"

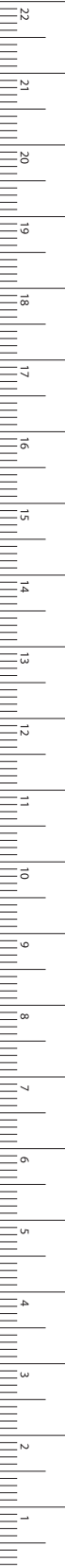

MILLIMETERS

Herz- und Gefäß-Chirurgie – Cardiovascular Surgery

DUROGRIP® Nadelhalter

DUROGRIP® Needle Holders

»grazil«

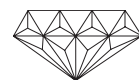

FB

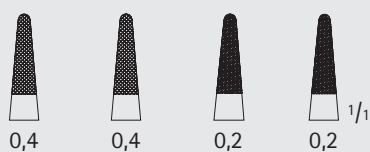

BM033R	BM034R	BM063R	BM064R
165 mm	210 mm	165 mm	210 mm
6 1/2"	8 1/4"	6 1/2"	8 1/4"

DE BAKAY

BM033R-BM064R

sehr fein

very delicate

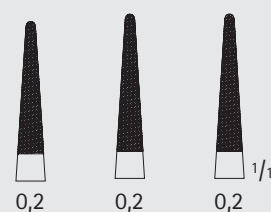

BM025R	BM026R	BM027R
180 mm	200 mm	230 mm
7"	8"	9"

BM025R-BM027R

sehr fein

very delicate

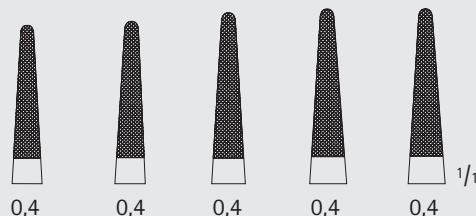

BM032R	BM035R	BM036R	BM037R	BM038R
150 mm	180 mm	230 mm	250 mm	305 mm
6"	7"	9"	10"	12"

DE BAKAY

BM032R-BM038R

1/2

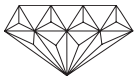

»grazil«

Herz- und Gefäß-Chirurgie – Cardiovascular Surgery

DUROGRIP® Nadelhalter
DUROGRIP® Needle Holders

FB



DE BAKEY

BM040R

schlankes Modell
slender pattern
305 mm, 12"

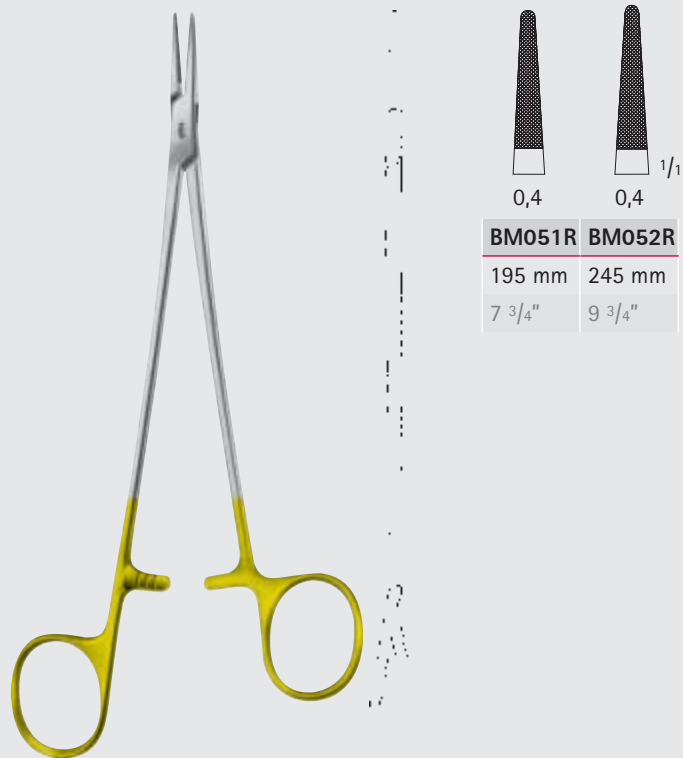

DE BAKEY

BM051R-BM052R

Ringe griffgünstig abgesetzt
und gebogen
one extended handle and curved
rings ensure optimum grip



MILLIMETERS

Herz- und Gefäß-Chirurgie – Cardiovascular Surgery

DUROGRIP® Nadelhalter

DUROGRIP® Needle Holders

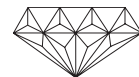

Diese Spezialmodelle mit extra schmalen Mäulern eignen sich für atraumatische Nadeln und für feine Gefäßnadeln.

These special patterns with extremely fine jaws are suitable for holding non-traumatic needles and fine vein needles.

FB



BM074R	BM075R	BM076R
150 mm	180 mm	230 mm
6"	7"	9"

RYDER

BM074R-BM076R

mit glattem Maul
with smooth jaws



1/2

BM184R

200 mm, 8"

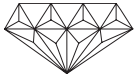

Herz- und Gefäß-Chirurgie – Cardiovascular Surgery

DUROGRIP® Nadelhalter
DUROGRIP® Needle Holders

Diese Spezialmodelle mit extra schmalen Mäulern eignen sich für atraumatische Nadeln und für feine Gefäßnadeln.

These special patterns with extremely fine jaws are suitable for holding non-traumatic needles and fine vein needles.

FB

»grazil«

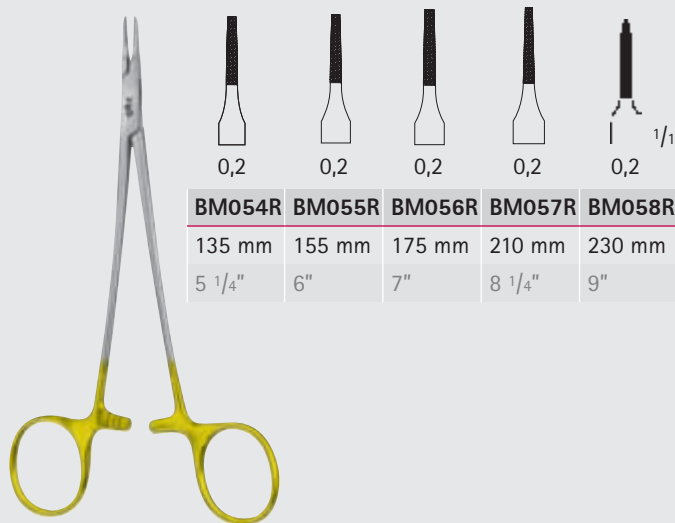

BM054R	BM055R	BM056R	BM057R	BM058R
135 mm	155 mm	175 mm	210 mm	230 mm
5 1/4"	6"	7"	8 1/4"	9"

RYDER

BM054R-BM058R

sehr fein
very delicate

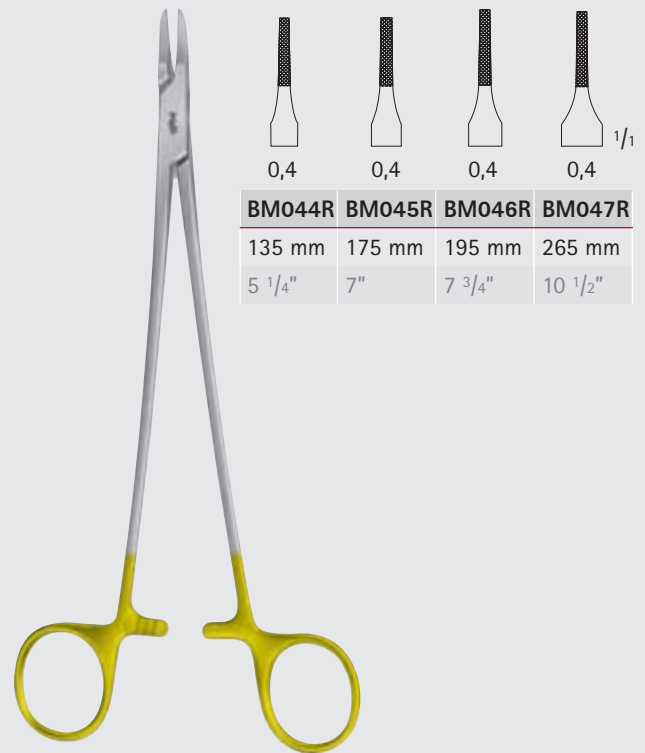

BM044R	BM045R	BM046R	BM047R
135 mm	175 mm	195 mm	265 mm
5 1/4"	7"	7 3/4"	10 1/2"

RYDER

BM044R-BM047R



MILLIMETERS



DE BAKY

1 : 2 Zahnreihen

1 : 2 rows of teeth



DE BAKY

2 : 3 Zahnreihen

2 : 3 rows of teeth

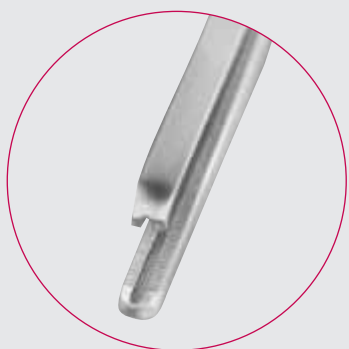

COOLEY

2 : 2 Zahnreihen

2 : 2 rows of teeth





DE BAKEY Zahnung

Herz- und Gefäß-Chirurgie – Cardiovascular Surgery

Ultra-Light-Pinzetten

Ultra-Light-Forceps

Toothing DE BAKEY

AIRAUMATA®

FB



Model	Tip Width	Length (mm)	Length (inches)
FC411R	1,2 mm	150 mm	6"
FC412R	1,5 mm	200 mm	8"
FC413R	1,5 mm	240 mm	9 1/2"
FC418R	1,5 mm	300 mm	12"

DE BAKEY
FC411R-FC418R



MILLIMETERS

Herz- und Gefäß-Chirurgie – Cardiovascular Surgery

Pinzetten
Forceps

DE BAKEY Zahnung

ARAUMATA[®] Toothing DE BAKEY

FB

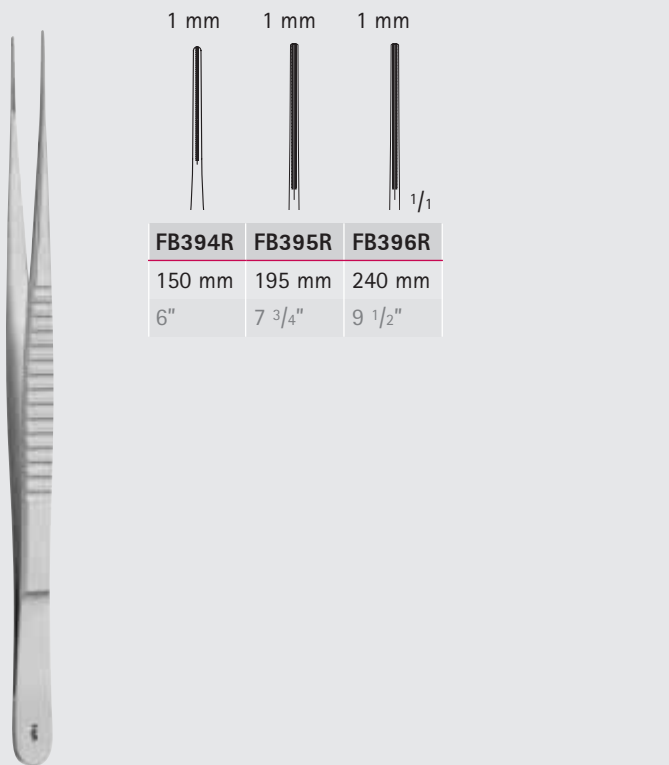

FB394R	FB395R	FB396R
150 mm	195 mm	240 mm
6"	7 3/4"	9 1/2"

DE BAKEY

FB394R-FB396R

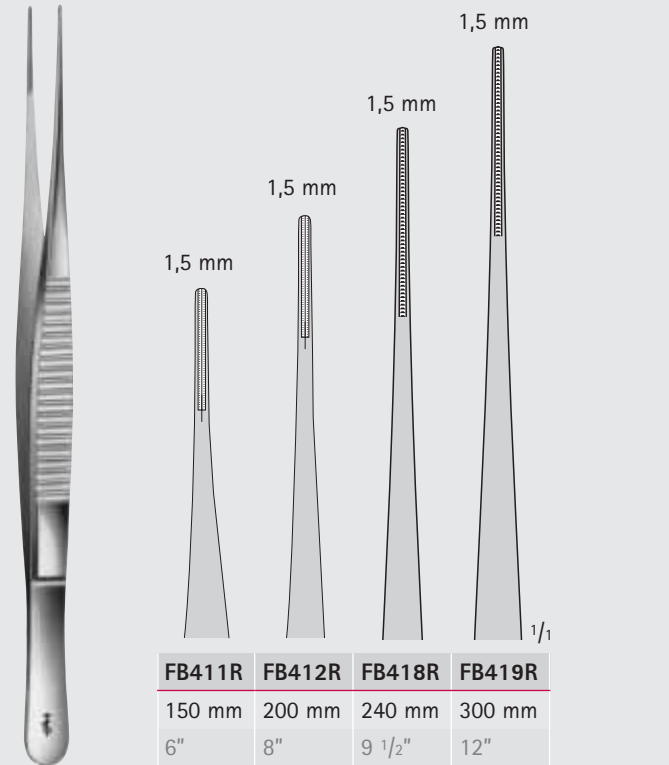

FB411R	FB412R	FB418R	FB419R
150 mm	200 mm	240 mm	300 mm
6"	8"	9 1/2"	12"

DE BAKEY

FB411R-FB419R

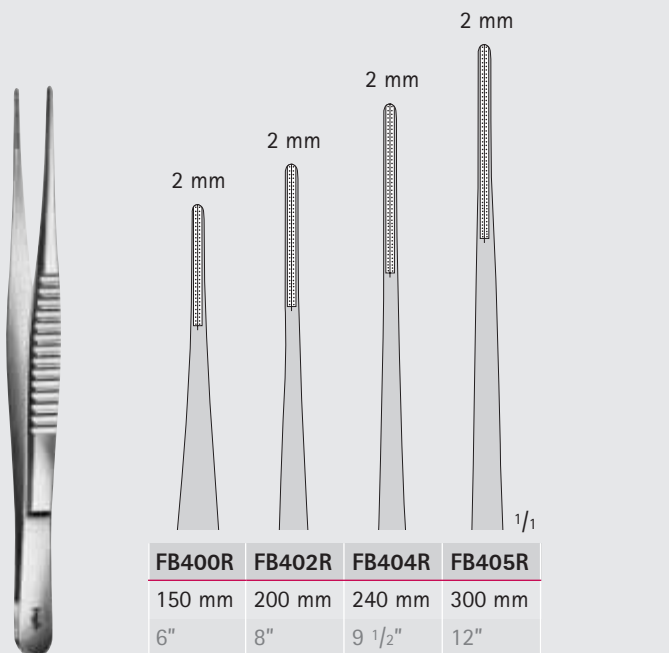

FB400R	FB402R	FB404R	FB405R
150 mm	200 mm	240 mm	300 mm
6"	8"	9 1/2"	12"

DE BAKEY

FB400R-FB405R

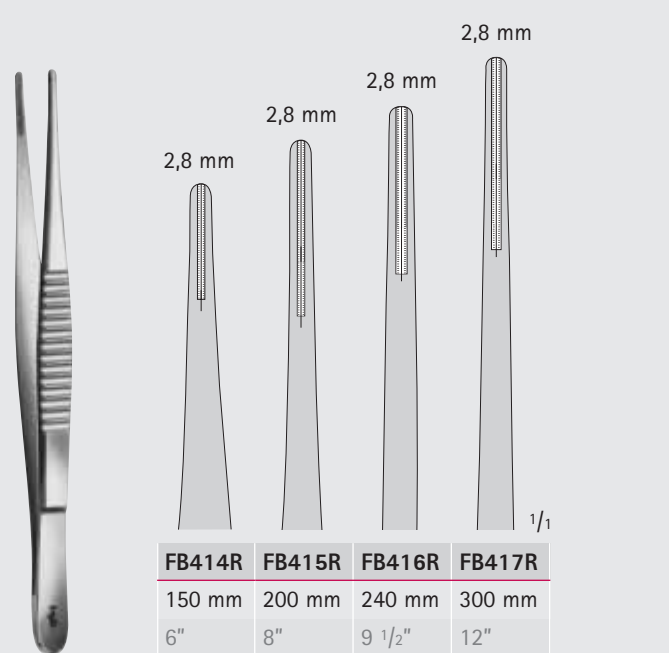

FB414R	FB415R	FB416R	FB417R
150 mm	200 mm	240 mm	300 mm
6"	8"	9 1/2"	12"

DE BAKEY

FB414R-FB417R



DE BAKEY Zahnung

Herz- und Gefäß-Chirurgie – Cardiovascular Surgery

Pinzetten
Forceps

Toothing DE BAKEY



FB406R	FB407R	FB408R	FB409R
200 mm	240 mm	300 mm	350 mm
8"	9 1/2"	12"	14"

DE BAKEY
FB406R-FB409R

COOLEY Zahnung

Toothing COOLEY

FB784R	FB785R	FB786R
150 mm	195 mm	240 mm
6"	7 3/4"	9 1/2"

COOLEY
FB784R-FB786R

DE BAKEY
FB401R

150 mm, 6"

DE BAKEY
FB403R

200 mm, 8"

COOLEY
BD250R

200 mm, 8"

FB

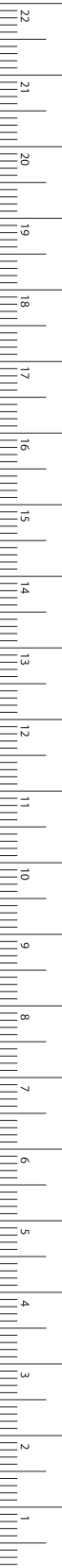

Gefäßclips nach MÜLLER

Merkmale:

- Atraumatisches Maulprofil
- Beidseitig angebrachte Griffplateaus zum sicheren Anlegen und Abnehmen des Clips.
- Exakt definierter Schließdruck für arterielle und venöse Gefäße.
- Gefäßclips eindeutig mit Schließdruck gekennzeichnet.
- Geschlossener Maulkasten zur sicheren Maulführung. Kein ungewolltes Verfangen des Fadens möglich.

MÜLLER Vascular Clips

Features:

- Atraumatic mouth profile
- Handle plateau mounted on both sides for secure application and removal of the clip.
- Exactly defined closing pressure for arterial and venous vessels.
- Vascular clips are clearly marked with closing pressure.
- Closed mouth box guarantees precise guidance of the working tips. No risk of threads getting tangled up in clip.

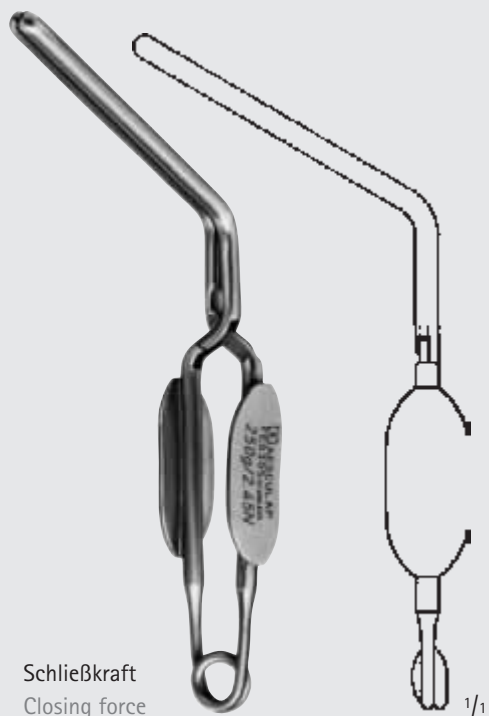

Schließkraft
Closing force

MÜLLER
250 g **FE030S**
350 g **FE040S**
gerade
straight

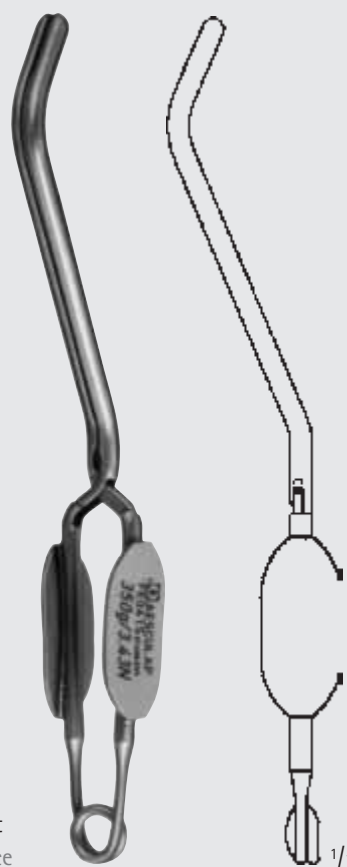

Schließkraft
Closing force

MÜLLER
250 g **FE031S**
350 g **FE041S**
gebogen
curved





DE BAKEY Zahnung

Toothing DE BAKEY

Herz- und Gefäß-Chirurgie – Cardiovascular Surgery

Gefäßclips
Vascular Clips

FB



Schließkraft
Closing force

MÜLLER

250 g **FE032S**

350 g **FE042S**

Spitze gebogen
curved tips

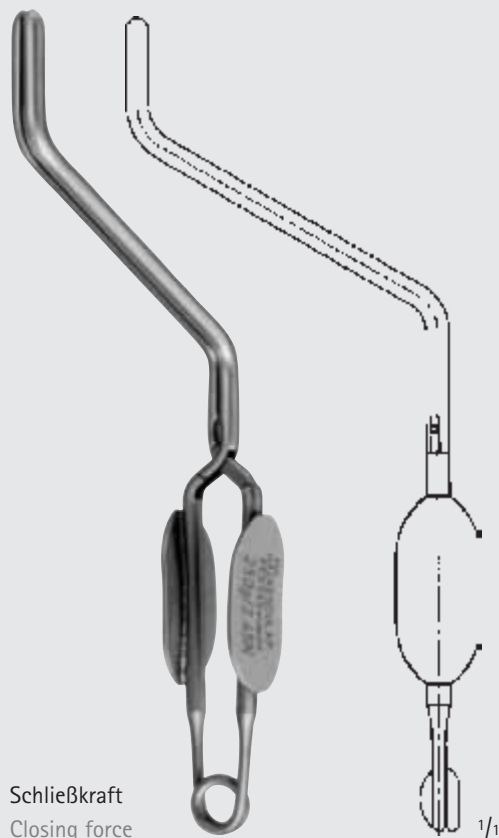

Schließkraft
Closing force

MÜLLER

250 g **FE034S**

350 g **FE044S**

kniegebogen
knee-bent

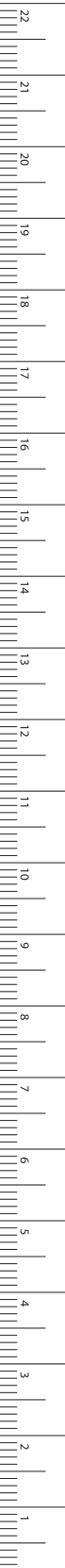

MILLIMETERS

Herz- und Gefäß-Chirurgie – Cardiovascular Surgery

Bulldogklemmen

Bulldog Clamps

FB



JOHNS-HOPKINS

BH018R

Zange zum Anlegen und Abnehmen der Bulldogklemmen BH011R - BH031R und FB420R - FB427R

Forceps for applying and removing bulldog clamps BH011R - BH031R and FB420R - FB427R

240 mm, 9 3/4"

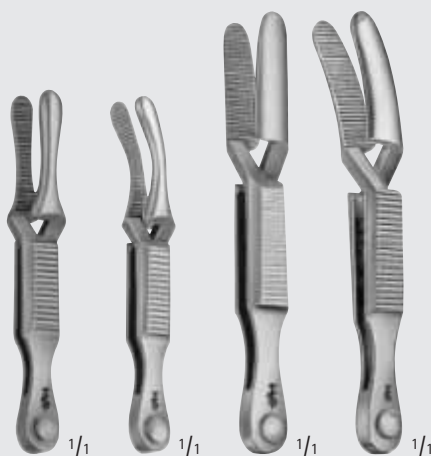

BH020R **BH021R** **BH026R** **BH027R**
BH022R **BH023R**

DIEFFENBACH

Gesamtlänge: Maullänge:
 Total length: Jaw length:

BH020R	38 mm, 1 1/2"	12 mm, 1/2"
BH022R	48 mm, 2"	16 mm, 5/8"
BH021R	38 mm, 1 1/2"	12 mm, 1/2"
BH023R	48 mm, 2"	16 mm, 5/8"
BH026R	58 mm, 2 1/8"	16 mm, 5/8"
BH027R	58 mm, 2 1/8"	16 mm, 5/8"



BH011R-BH017R

JOHNS-HOPKINS

Gesamtlänge: Maullänge:
 Total length: Jaw length:

BH011R	38 mm, 1 1/2"	12 mm, 1/2"
BH012R	48 mm, 2"	17 mm, 5/8"
BH013R	56 mm, 2 1/8"	25 mm, 1"
BH014R	63 mm, 2 1/2"	30 mm, 1 3/16"
BH015R	70 mm, 2 3/4"	33 mm, 1 1/4"
BH016R	80 mm, 3 1/8"	42 mm, 1 3/4"
BH017R	91 mm, 3 1/2"	52 mm, 2"





Herz- und Gefäß-Chirurgie – Cardiovascular Surgery

Bulldogklemmen

Bulldog Clamps

FB



1/1

DE BAKEY-HESS

BH030R

Gesamtlänge: 34 mm
 Total length: 1 3/8"
 Maullänge: 20 mm
 Jaw length: 3/4"



FB328R

Gesamtlänge: 35 mm
 Total length: 1 3/8"
 Maullänge: 14 mm
 Jaw length: 1/2"



FB329R

Gesamtlänge: 35 mm
 Total length: 1 3/8"
 Maullänge: 14 mm
 Jaw length: 1/2"



FB330R

Gesamtlänge: 45 mm
 Total length: 1 3/4"
 Maullänge: 19 mm
 Jaw length: 3/4"



1/1

FB331R

Gesamtlänge: 45 mm
 Total length: 1 3/4"
 Maullänge: 19 mm
 Jaw length: 3/4"



1/1

DE BAKEY-HESS

BH031R

Gesamtlänge: 43 mm
 Total length: 1 7/10"
 Maullänge: 30 mm
 Jaw length: 1 3/16"



DIETHRICH

MB285R

Gesamtlänge: 55 mm
 Total length: 2 1/8"
 Maullänge: 13 mm
 Jaw length: 1/2"



DIETHRICH

BH032R

Gesamtlänge: 48 mm
 Total length: 1 7/8"
 Maullänge: 10 mm
 Jaw length: 3/8"



1/1

DIETHRICH

BH034R

Gesamtlänge: 48 mm
 Total length: 1 7/8"
 Maullänge: 13 mm
 Jaw length: 1/2"



MILLIMETERS

Herz- und Gefäß-Chirurgie – Cardiovascular Surgery

Bulldogklemmen

Bulldog Clamps

DE BAKEY Zahnung

ARAUMATA®

Toothing DE BAKEY

Mini-Bulldogklemmen

Schließdruck 180 g

Mini-bulldog clamps

Closing force 180 g

gerade
straight



gewinkelt, 55°
angled, 55°



curved
gebogen

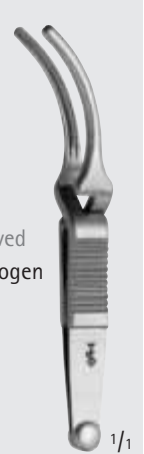

	FB362R	FB364R	FB366R	FB363R	FB365R	FB367R	FB369R
Gesamtlänge:	50 mm	55 mm	60 mm	50 mm	50 mm	55 mm	55 mm
Total length:	2"	2 1/8"	2 3/8"	2"	2"	2 1/8"	2 1/8"
Maullänge:	10 mm	14 mm	20 mm	10 mm	14 mm	20 mm	20 mm
Jaw length:	3/8"	1/2"	3/4"	3/8"	1/2"	3/4"	3/4"



DE BAKEY
FB352R



DE BAKEY
FB353R



GLOVER
FB431R



DE BAKEY
FB357R



DE BAKEY
FB358R



DE BAKEY
FB359R

Gesamtlänge:	50 mm	48 mm	52 mm	73 mm	99 mm	95 mm
Total length:	2"	2"	2"	2 3/4"	4"	3 1/2"
Maullänge:	27 mm	27 mm	35 mm	38 mm	63 mm	54 mm
Jaw length:	1 1/8"	1 1/8"	1 1/3"	1 1/2"	2 1/2"	2 1/8"



DE BAKEY Zahnung

Herz- und Gefäß-Chirurgie – Cardiovascular Surgery

Bulldogklemmen
Bulldog Clamps

Toothing DE BAKEY **AIRAUMATA®**

FB



DE BAKEY

FB420R

Gesamtlänge: 80 mm

Total length: 3 1/8"

Maullänge: 25 mm

Length of jaw: 1"

DE BAKEY

FB422R

90 mm

3 1/2"

35 mm

1 3/8"

DE BAKEY

FB424R

105 mm

4 1/8"

50 mm

2"

DE BAKEY

FB426R

124 mm

5"

68 mm

2 3/4"



DE BAKEY

FB421R

78 mm

3 1/8"

23 mm

1"

DE BAKEY

FB423R

86 mm

3 3/8"

31 mm

1 1/8"

DE BAKEY

FB425R

97 mm

3 3/4"

42 mm

1 3/4"

DE BAKEY

FB427R

114 mm

4 1/2"

58 mm

2 3/8"



GLOVER

FB432R

Gesamtlänge: 68 mm

Total length: 2 3/4"

Maullänge: 33 mm

Length of jaw: 1 3/8"

GLOVER

FB434R

96 mm

3 3/4"

50 mm

2"

GLOVER

FB436R

117 mm

4 3/4"

69 mm

2 3/4"



GLOVER

FB433R

65 mm

2 1/2"

33 mm

1 3/8"

GLOVER

FB435R

91 mm

3 1/2"

50 mm

2"

GLOVER

FB437R

110 mm

4 3/8"

69 mm

2 3/4"



MILLIMETERS

Herz- und Gefäß-Chirurgie – Cardiovascular Surgery

Bulldogklemmen mit Ringgriffen

Ring Handle Bulldog Clamps

DE BAKEY Zahnung

ARAUMATA®

Toothing DE BAKEY

FB



DE BAKEY

FB540R

gerade

straight

130 mm, 5 1/8"



DE BAKEY

FB541R

Maul gebogen

curved jaws

125 mm, 5"

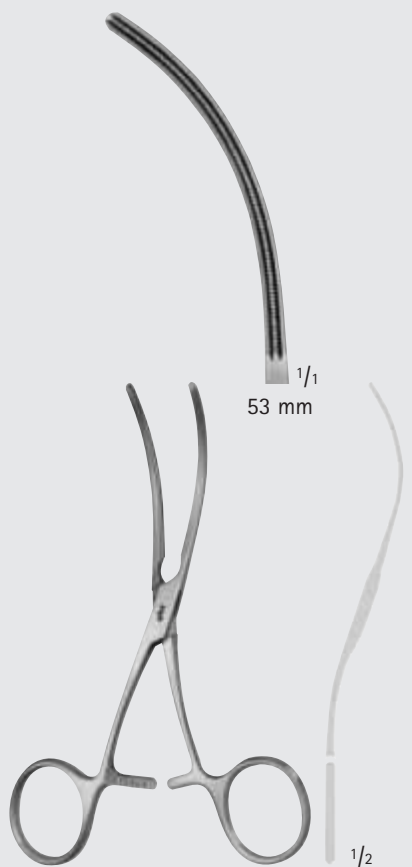

DE BAKEY

FB542R

S-förmig

S-shaped

125 mm, 5"

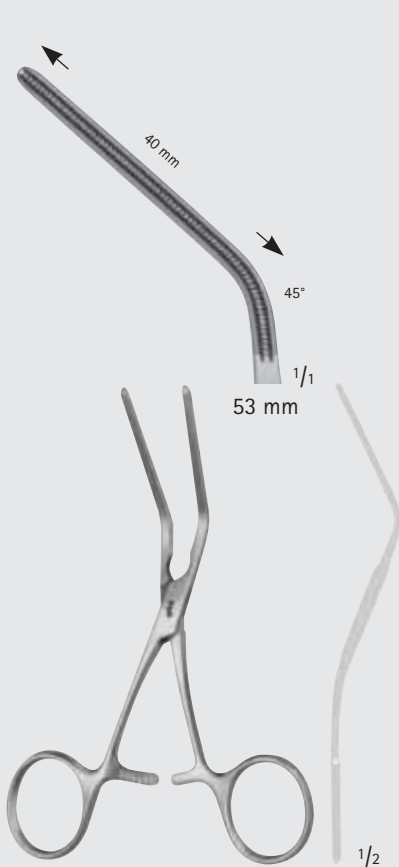

DE BAKEY

FB543R

45° winklig gebogen

angled 45°

125 mm, 5"

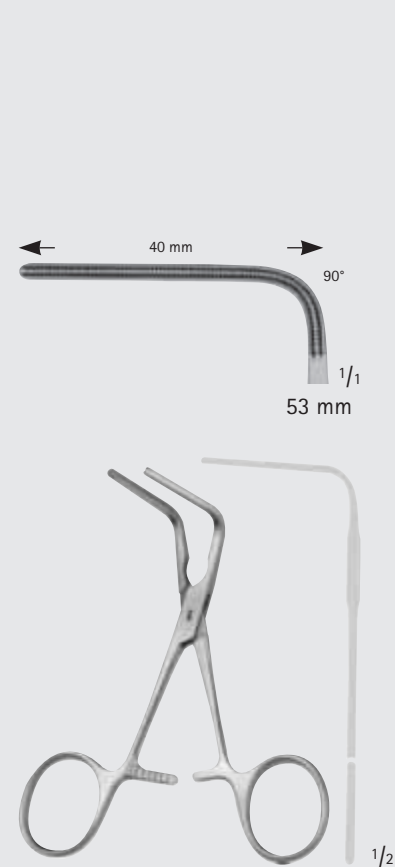

DE BAKEY

FB544R

90° winklig gebogen

angled 90°

105 mm, 4 1/8"



DE BAKEY Zahnung

Herz- und Gefäß-Chirurgie – Cardiovascular Surgery

Anastomosen-, Mehrzweckklemmen für Neugeborene

Anastomosis-, Multi-Purpose-Clamps for Neonatales

Toothing DE BAKEY

AIRAUMATA®

FB



CASTANEDA

FB581R-FB582R

120 mm, 4 3/4"

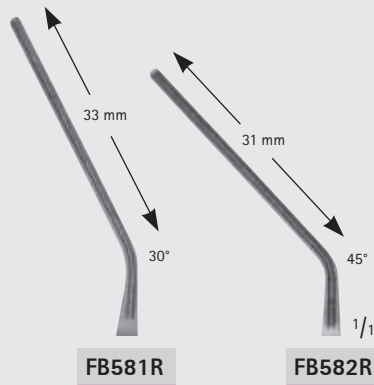

CASTANEDA

FB590R-FB593R

155 mm, 6"

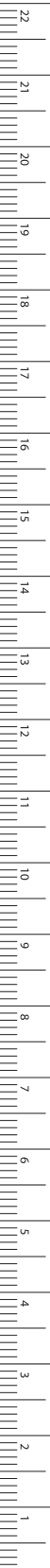

MILLIMETERS

Herz- und Gefäß-Chirurgie – Cardiovascular Surgery

Anastomosen- und Mehrzweckklemmen - Kinder-Modelle

Anastomosis- and Multi-Purpose-Clamps - Pediatric Patterns

AIRAUMATA®

DE BAKEY Zahnung

Toothing DE BAKEY

FB



DE BAKEY

FB557R-FB558R

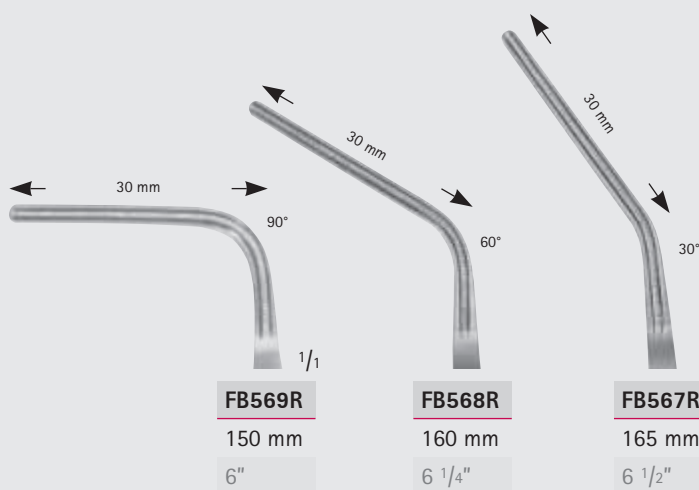

COOLEY

FB567R-FB569R



DE BAKEY Zahnung

Herz- und Gefäß-Chirurgie – Cardiovascular Surgery

Anastomosen-, Mehrzweckklemmen - Kinder-Modelle

Toothing DE BAKEY

AIRAUMATA®

Anastomosis-, Multi-Purpose-Clamps - Pediatric Patterns

FB

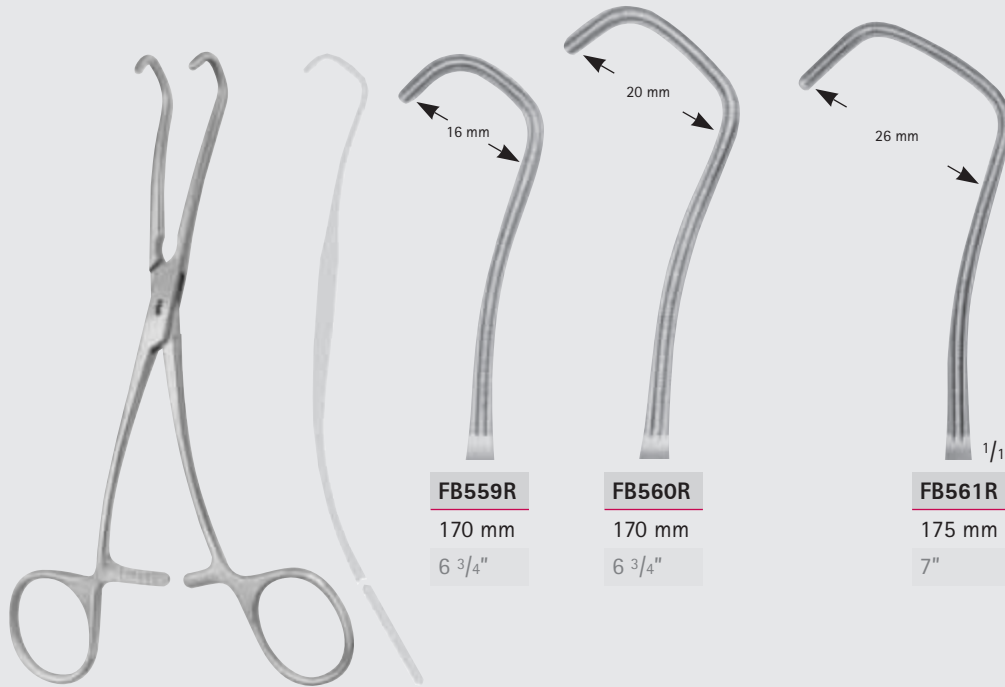

FB559R

170 mm

6 3/4"

FB560R

170 mm

6 3/4"

FB561R

175 mm

7"

DERRA

FB559R-FB561R

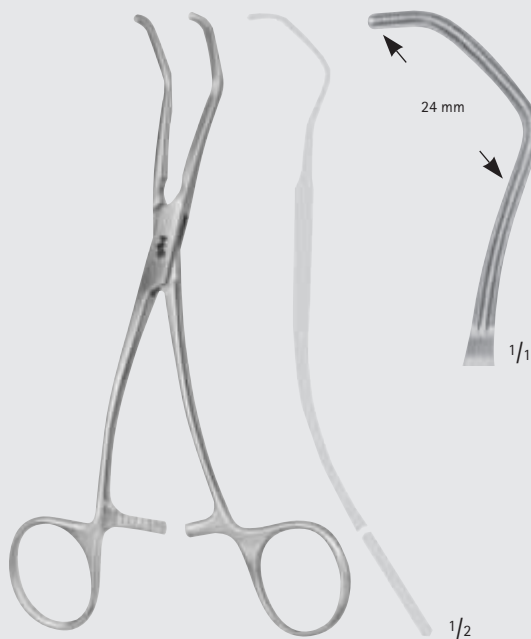

24 mm

1/1

1/2

90 mm

1/1

1/2

COOLEY

FB563R

160 mm, 6 1/4"

COOLEY

FB570R

200 mm, 8"

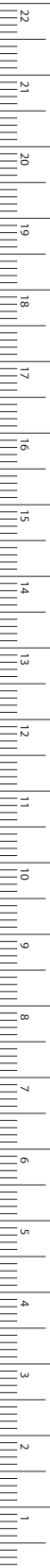

MILLIMETERS

Herz- und Gefäß-Chirurgie – Cardiovascular Surgery

Gefäßklemmen

Hemostatic Forceps

DE BAKEY Zahnung

ARAUMATA®

Toothing DE BAKEY

FB

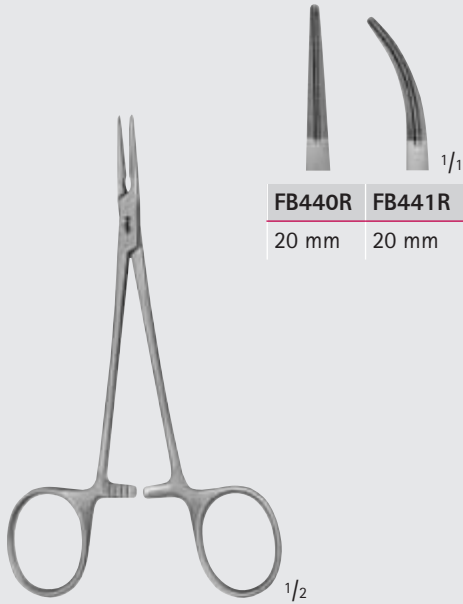

FB440R	FB441R
20 mm	20 mm

FB440R-FB441R

Mosquitoklemmen
Mosquito Forceps
125 mm, 5"



FB442R	FB443R
27 mm	27 mm

FB442R-FB443R

Mosquitoklemmen
Mosquito forceps
165 mm, 6 1/2"



FB446R	FB447R
40 mm	40 mm

DE BAKEY-BAINBRIDGE

FB446R-FB447R

155 mm, 6"



FB448R	FB449R
65 mm	65 mm

DE BAKEY-BAINBRIDGE

FB448R-FB449R

180 mm, 7"



DE BAKEY Zahnung

Herz- und Gefäß-Chirurgie – Cardiovascular Surgery

Gefäßklemmen

Toothing DE BAKEY

AIRAUMATA®

Hemostatic Forceps

FB

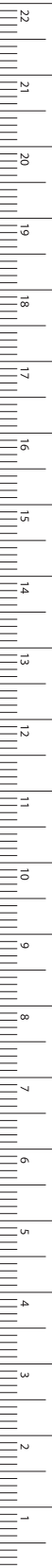

MILLIMETERS



1/2



1/1

FB444R	FB445R
50 mm	50 mm

PEAN

FB444R-FB445R
155 mm, 6"



DE BAKEY-PEAN

FB526R-FB535R

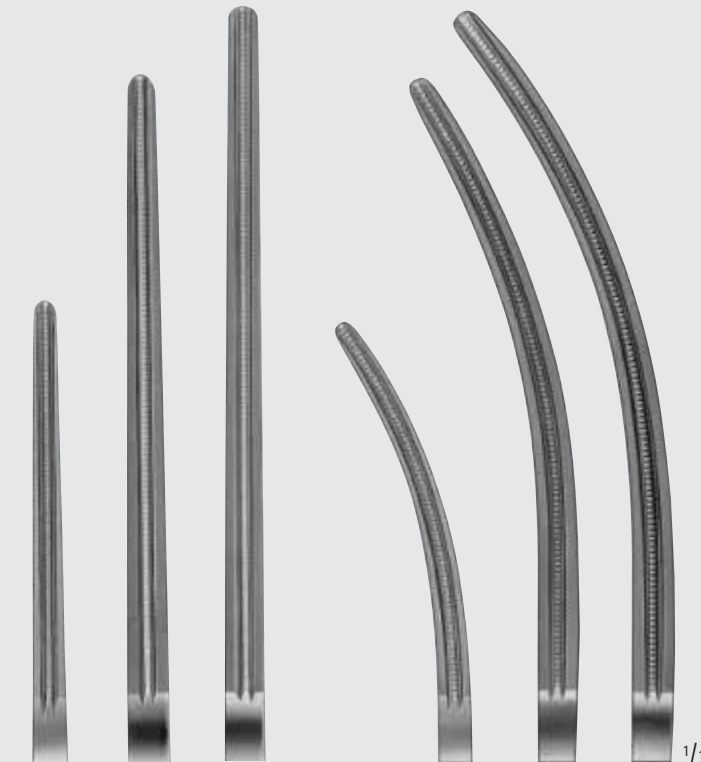

1/1

FB526R	FB532R	FB534R
60 mm	89 mm	99 mm
200 mm	265 mm	280 mm
8"	10 1/2"	11"

FB527R	FB533R	FB535R
60 mm	89 mm	99 mm
200 mm	260 mm	275 mm
8"	10 1/4"	10 3/4"

Herz- und Gefäß-Chirurgie – Cardiovascular Surgery

Klemmen für Nieren- und Pankreaseingriffe

Kidney and Pankreas Clamps

DE BAKEY Zahnung

ARAUMATA®

Toothing DE BAKEY

FB

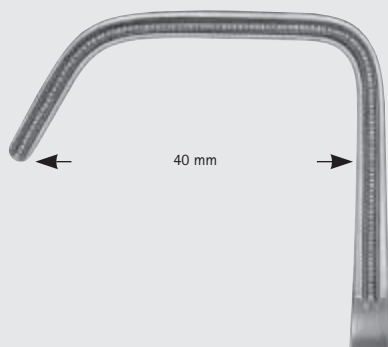

40 mm

FB528R

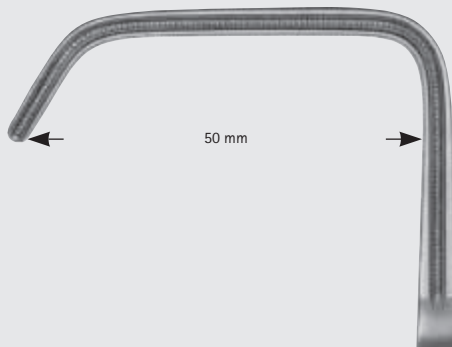

50 mm

FB529R



HOPT



65 mm

FB530R

1/1

FB528R	230 mm	9"
FB529R	235 mm	9 1/4"
FB530R	245 mm	9 3/4"



DE BAKEY Zahnung

Herz- und Gefäß-Chirurgie – Cardiovascular Surgery

Präparier- und Ligaturklemmen

Dissecting- and Ligature Forceps

Toothing DE BAKEY

AIRAUMATA®

FB

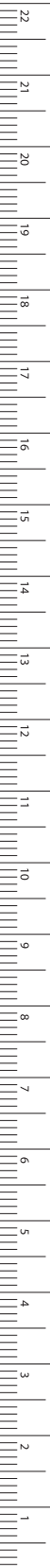

FB486R
81 mm

FB487R
81 mm

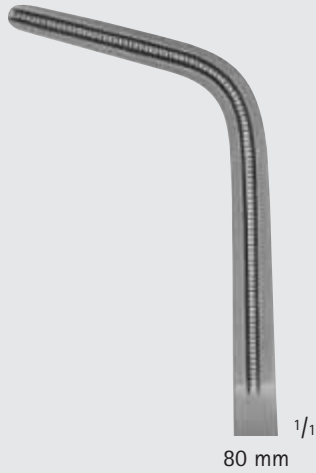

FB497R
80 mm



FB496R
70 mm



DE BAKEY-RUMEL

FB486R	250 mm	10"
FB487R	245 mm	9 3/4"



DE BAKEY-MIXTER

FB497R	285 mm, 11 1/4"
---------------	-----------------



DE BAKEY-MC QUIGG-MIXTER

FB496R	210 mm, 8 1/4"
---------------	----------------

MILLIMETERS

Herz- und Gefäß-Chirurgie – Cardiovascular Surgery

Präparier- und Ligaturklemmen, Profunda Klemmen

Dissecting- and Ligature Forceps, Profunda Clamps

DE BAKEY Zahnung

AIRAUMATA[®]

Toothing DE BAKEY

FB

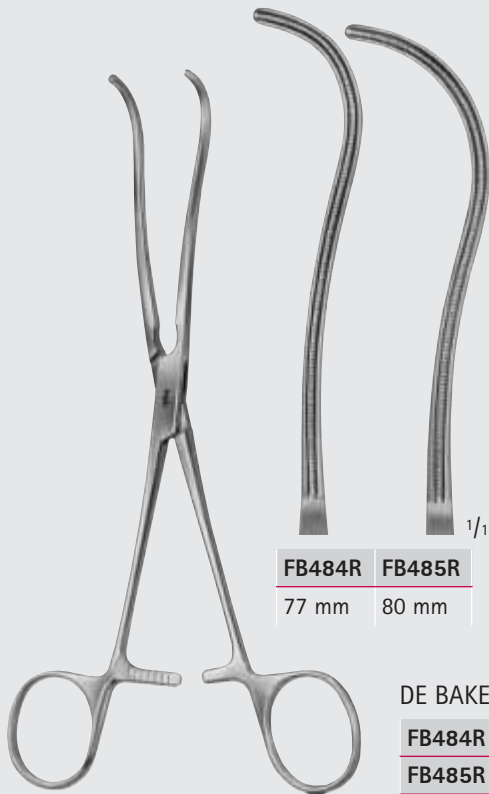

FB484R	FB485R
77 mm	80 mm

DE BAKEY

FB484R	190 mm	7 1/2"
FB485R	230 mm	9"



GREGORY

MB750R 57 mm

MB751R 62 mm

Profunda Klemmen

Profunda clamps

200 mm, 8"

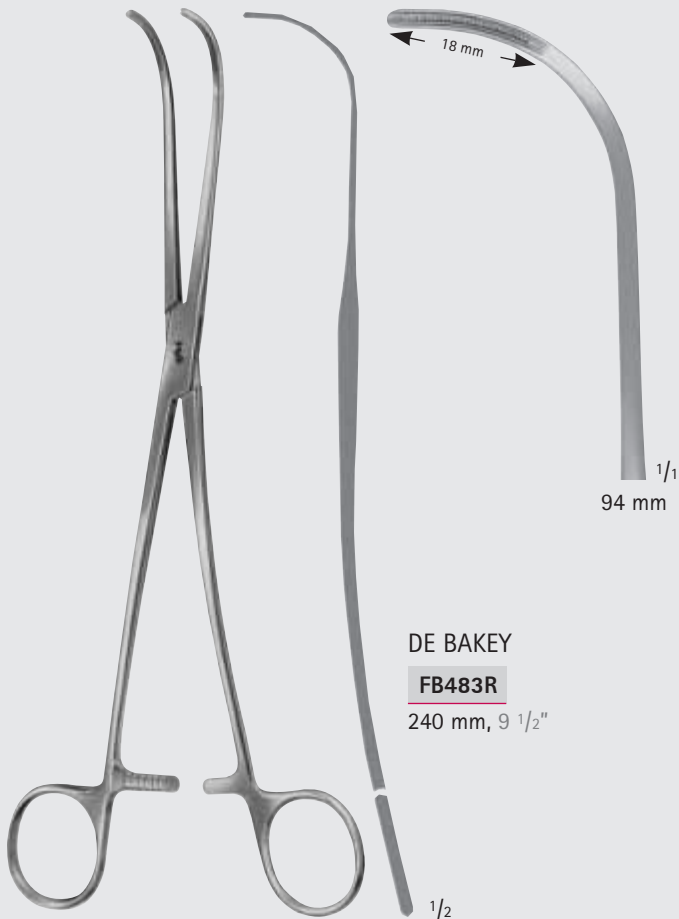

94 mm

DE BAKEY

FB483R	240 mm, 9 1/2"
---------------	----------------



FB498R	FB499R
51 mm	75 mm

DE BAKEY

FB498R	210 mm	8 1/4"
FB499R	230 mm	9"



DE BAKEY Zahnung

Herz- und Gefäß-Chirurgie – Cardiovascular Surgery

Anastomosenklemmen

Anastomosis Clamps

Toothing DE BAKEY AIRAUMATA®

FB

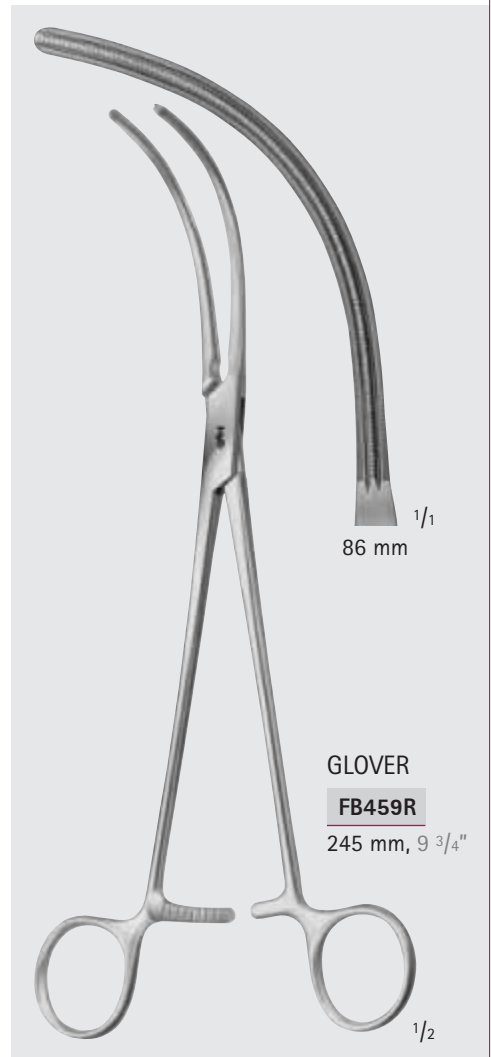
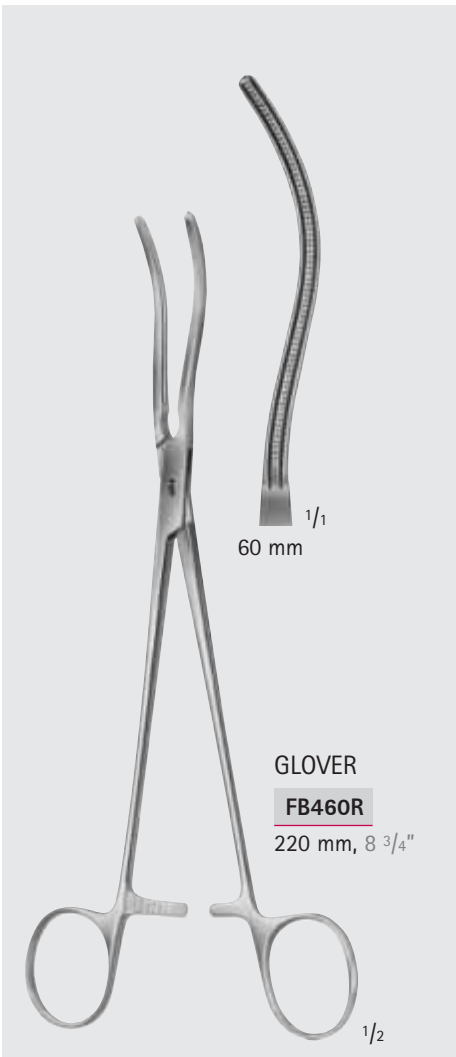
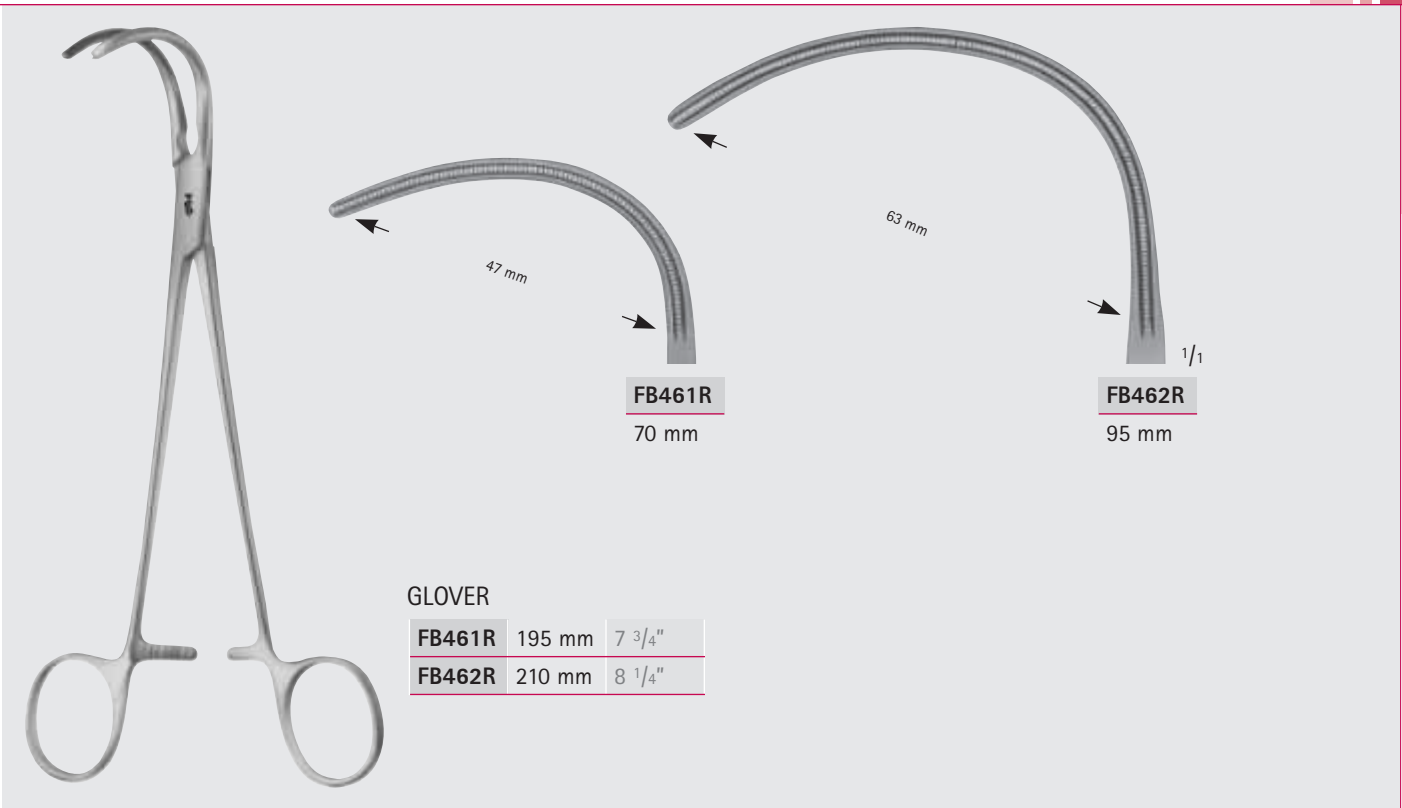

Herz- und Gefäß-Chirurgie – Cardiovascular Surgery

Vena-Cava-Klemmen

Vena Cava Clamps

DE BAKEY Zahnung

AIRAUMATA®

Toothing DE BAKEY

FB

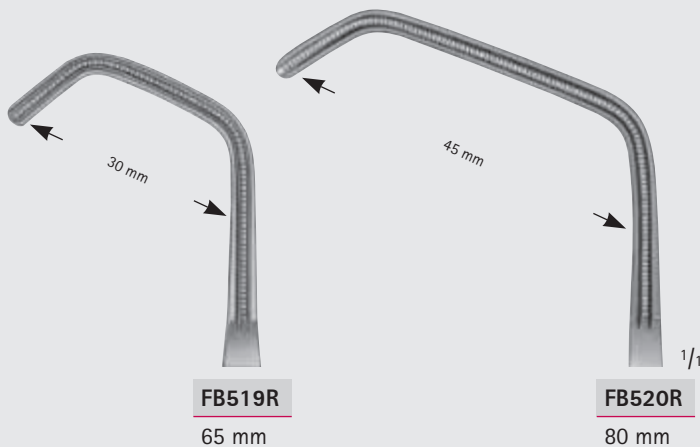

DE BAKEY-BECK

FB519R	205 mm	8"
FB520R	210 mm	8 1/4"

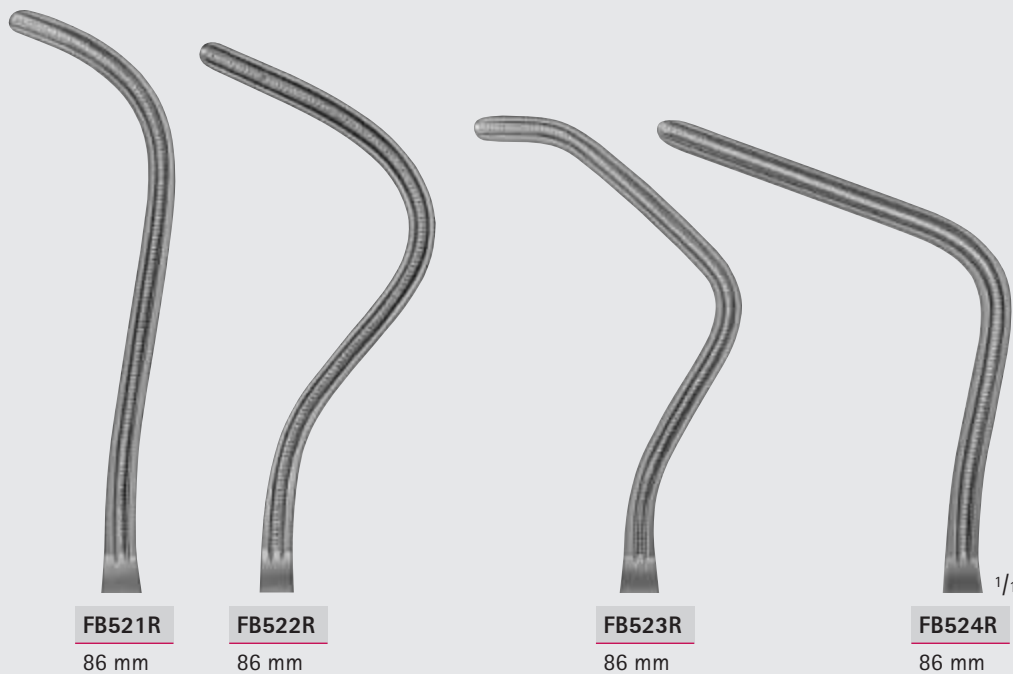

DE BAKEY-HARKEN

FB521R	255 mm	10"
FB522R	245 mm	9 3/4"
FB523R	245 mm	9 3/4"
FB524R	245 mm	9 3/4"



DE BAKEY Zahnung

Herz- und Gefäß-Chirurgie – Cardiovascular Surgery

Gefäßklemmen für Tangential-Verschluss

Tangential Occlusion Clamps

Toothing DE BAKEY

AIRAUMATA®

FB

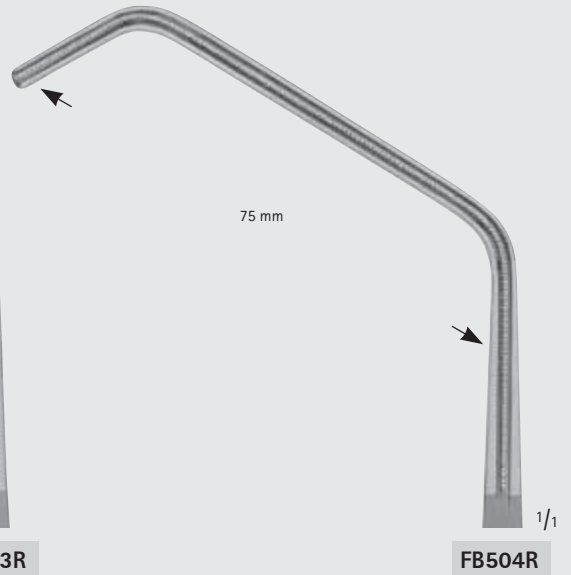
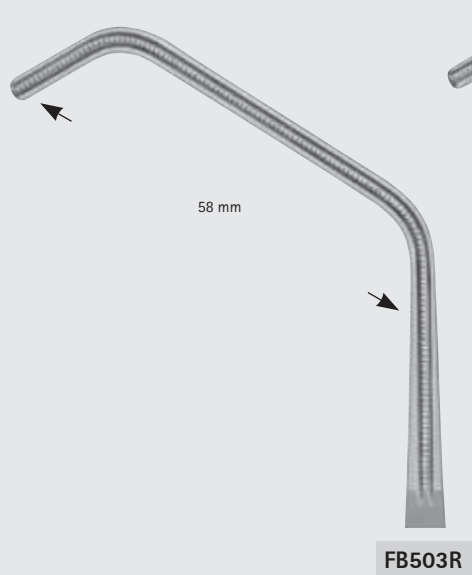
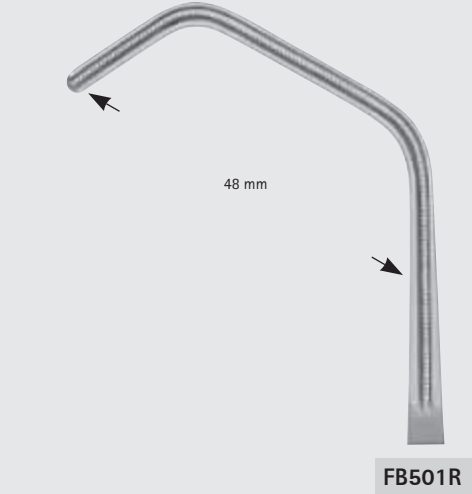
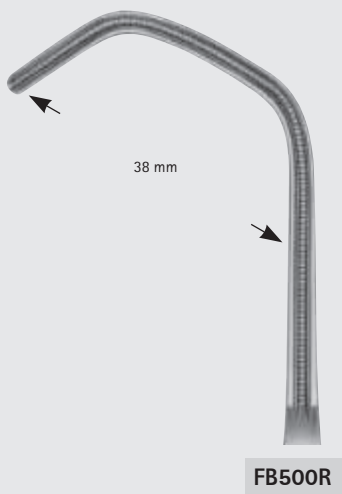

DE BAKEY

Gesamtlänge:
Total Length:
Maullänge:
Jaw length:

	FB500R	FB501R	FB502R	FB503R	FB504R
Gesamtlänge:	220 mm	265 mm	270 mm	270 mm	280 mm
Total Length:	7 3/4"	10 1/4"	10 3/4"	10 3/4"	11"
Maullänge:	85 mm	95 mm	99 mm	103 mm	119 mm
Jaw length:	3 3/8"	3 3/4"	4"	4 1/8"	4 3/4"

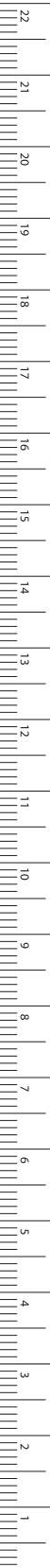

MILLIMETERS

FB

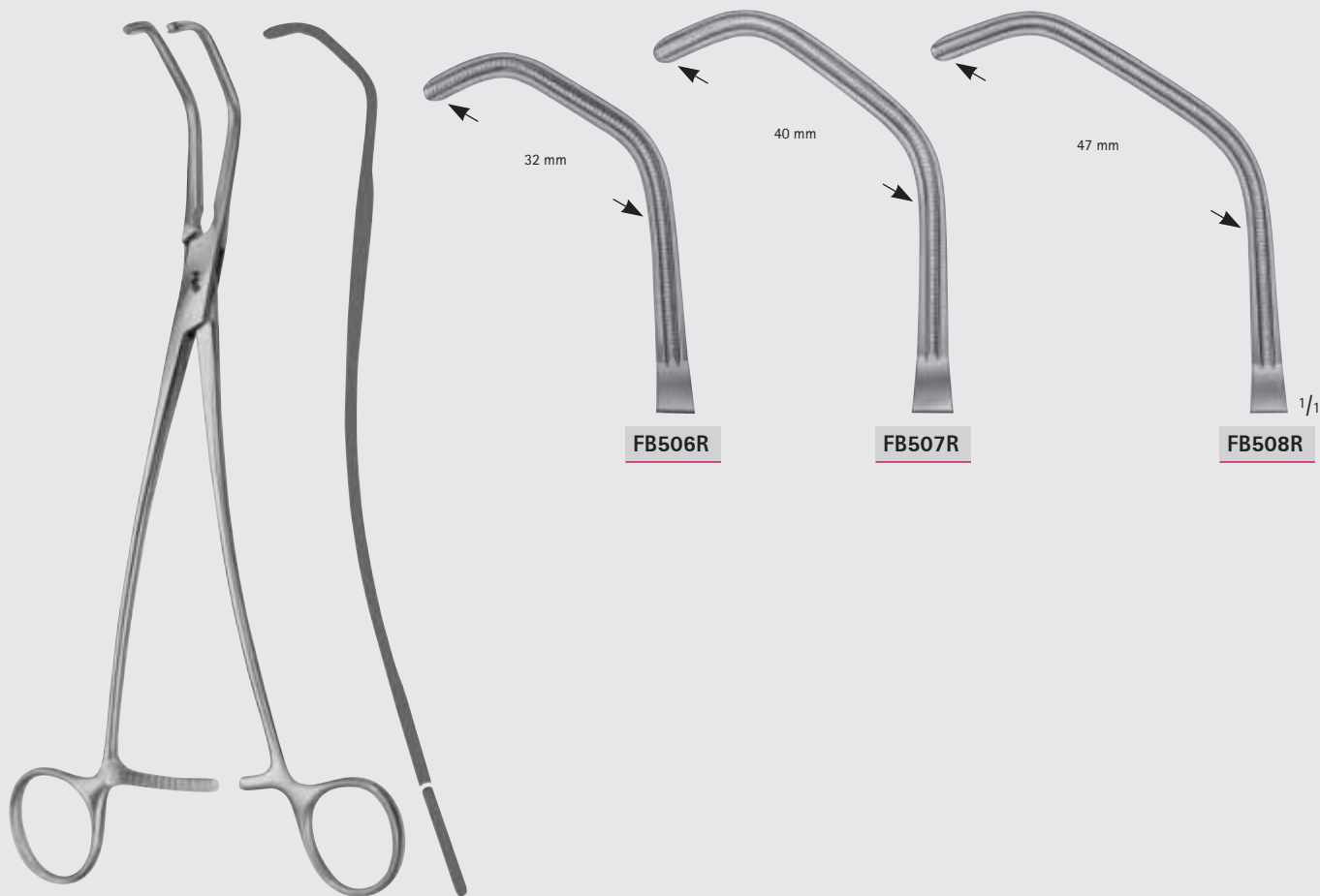

DE BAKEY-SATINSKY

	FB506R	FB507R	FB508R
Gesamtlänge:	235 mm	240 mm	245 mm
Total Length:	9 1/4"	9 1/2"	9 3/4"
Maullänge:	68 mm	76 mm	84 mm
Jaw length:	2 3/4"	3"	3 3/8"



DE BAKEY Zahnung

Herz- und Gefäß-Chirurgie – Cardiovascular Surgery

Toothing DE BAKEY AIRAUMATA®

Gefäßklemmen
Hemostatic Forceps

FB

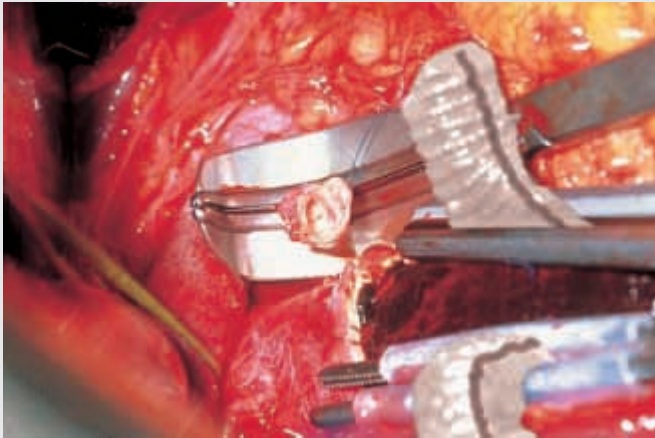

FB587R

235 mm

9 1/4"

FB588R

245 mm

9 3/4"

ALLENBERG

FB587R-FB588R

mit Retraktionsblättern zum Weghalten von Weichteilen während der Anastomose
with retraction blades for retraction of soft tissue during the anastomosis

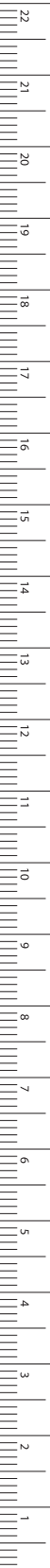

MILLIMETERS

Herz- und Gefäß-Chirurgie – Cardiovascular Surgery

Coarctationsklemmen
Coarctation Clamps

DE BAKEY Zahnung

ARAUMATA®

Toothing DE BAKEY

FB

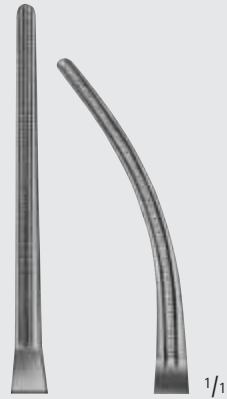

FB552R	FB554R
50 mm	50 mm

DE BAKEY

FB552R	170 mm	6 3/4"
FB554R	165 mm	6 1/2"

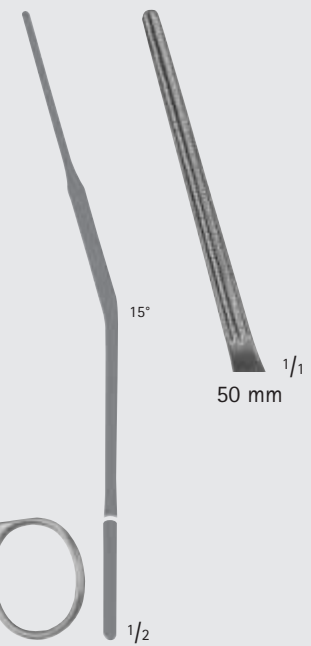

DE BAKEY

FB553R	165 mm, 6 1/2"
---------------	----------------

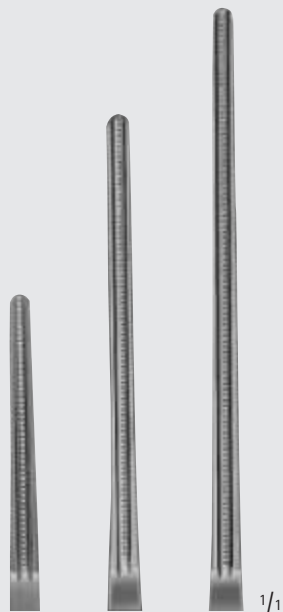

FB452R	FB454R	FB456R
41 mm	65 mm	80 mm

DE BAKEY

FB452R	205 mm	8"
FB454R	225 mm	9"
FB456R	240 mm	9 1/2"

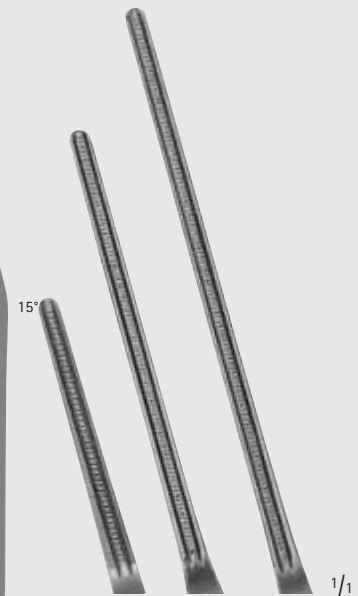

FB453R	FB455R	FB457R
41 mm	65 mm	80 mm

DE BAKEY

FB453R	200 mm	8"
FB455R	225 mm	9"
FB457R	240 mm	9 1/2"



DE BAKEY Zahnung

Herz- und Gefäß-Chirurgie – Cardiovascular Surgery

Patent-Ductusklemmen, Peripheralklemmen

Toothing DE BAKEY

AIRAUMATA®

Patent-Ductus-Clamps, Peripheral-Vascular-Clamps

FB



DE BAKEY

FB450R

210 mm, 8 1/4"

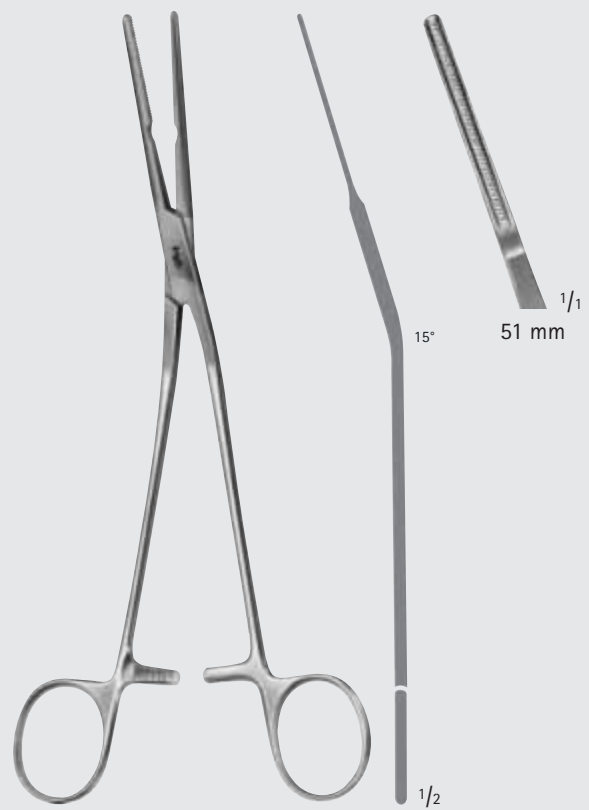

DE BAKEY

FB451R

210 mm, 8 1/4"

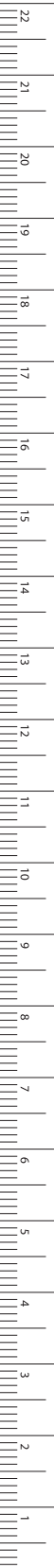

Herz- und Gefäß-Chirurgie – Cardiovascular Surgery

Patent-Ductusklemmen, Peripheralklemmen

Patent-Ductus-Clamps, Peripheral-Vascular-Clamps

DE BAKEY Zahnung

ARAUMATA®

Toothing DE BAKEY

FB

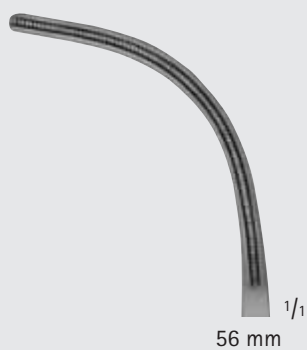

56 mm

1/1



90 mm

1/1



92,5 mm

1/1



1/2

DE BAKEY

FB463R

160 mm, 6 1/4"



1/2

DE BAKEY

FB464R

190 mm, 7 1/4"

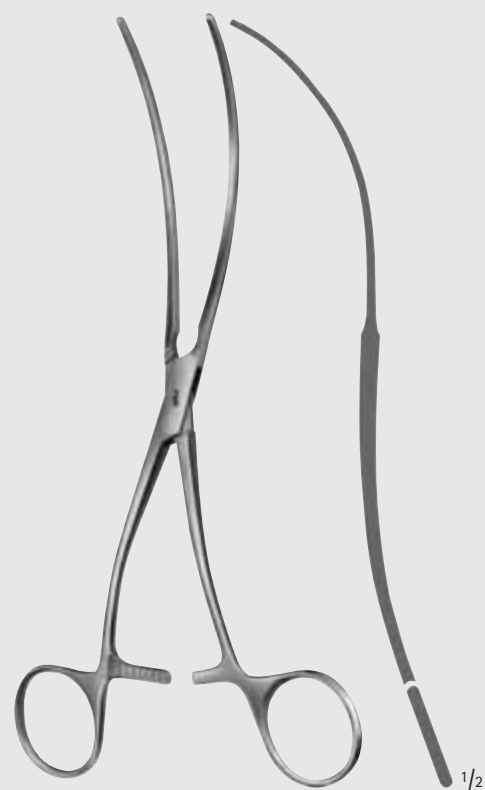

1/2

DE BAKEY

FB465R

200 mm, 8"



DE BAKEY Zahnung

Herz- und Gefäß-Chirurgie – Cardiovascular Surgery

Toothing DE BAKEY **AIRAUMATA®**

Peripheralklemmen
Peripheral-Vascular-Clamps

FB

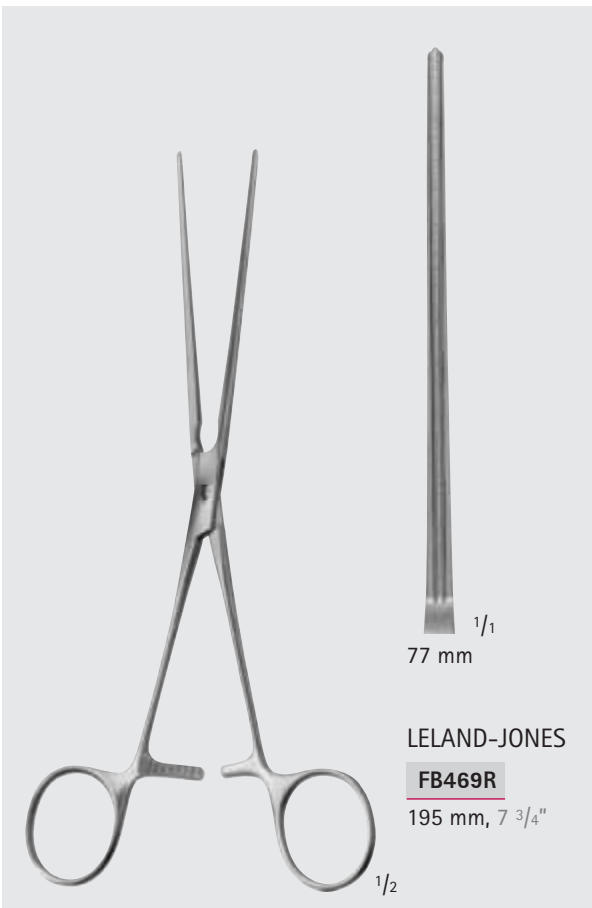
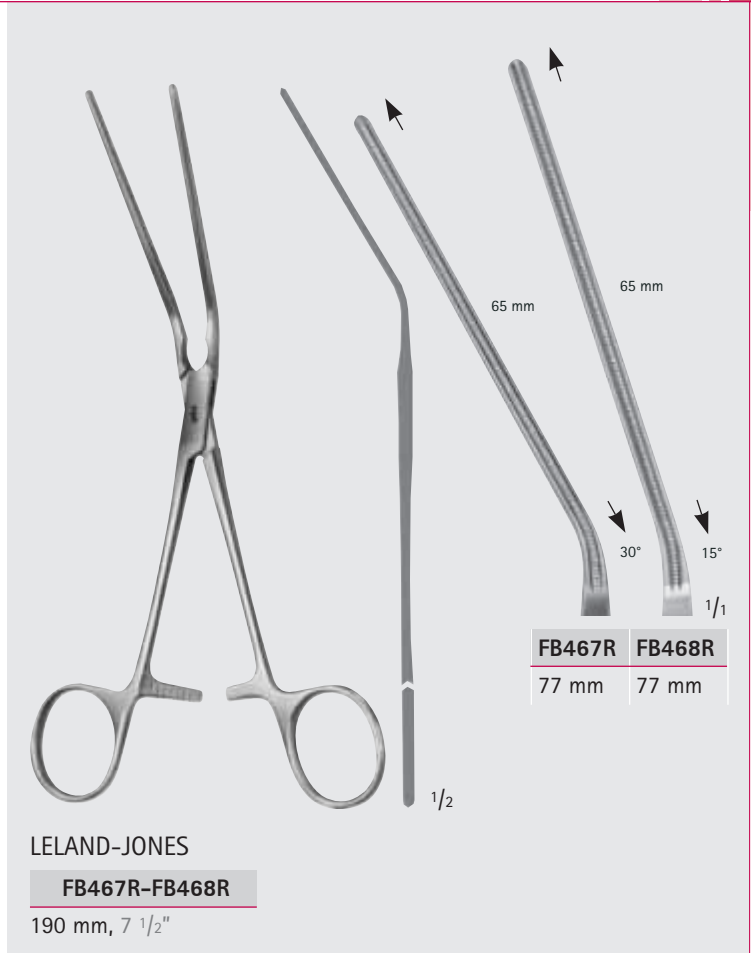
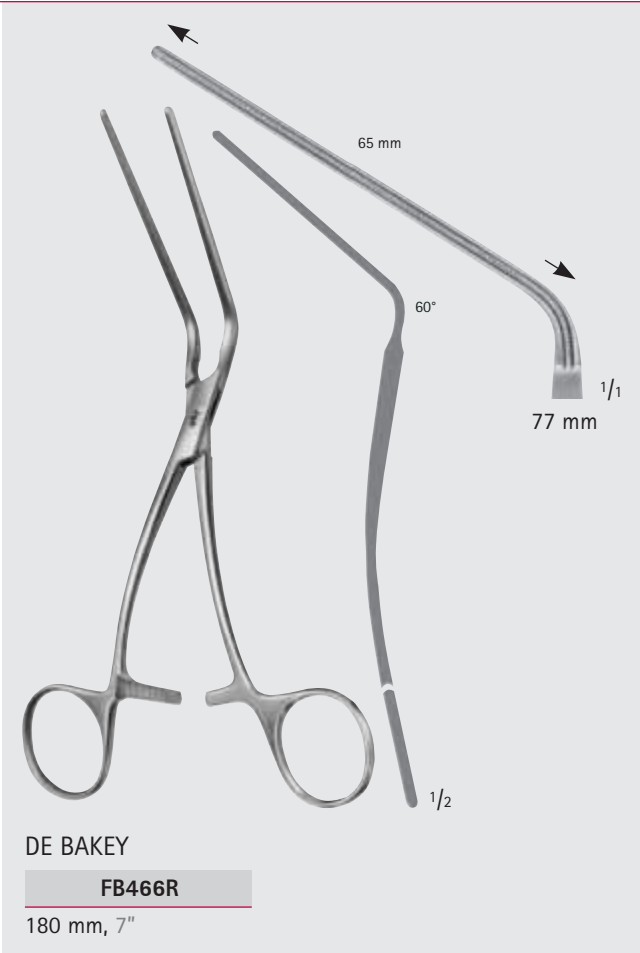

MILLIMETERS

Herz- und Gefäß-Chirurgie – Cardiovascular Surgery

Anastomosenklemmen

Anastomosis Clamps

DE BAKEY Zahnung

ARAUMATA®

Toothing DE BAKEY

FB



WERTHEIM

BJ581R

250 mm, 10"



FB956R

255 mm

10"

FB957R

265 mm

10 1/2"

FB958R

275 mm

10 3/4"

DICK

FB956R-FB958R



DE BAKEY Zahnung

Herz- und Gefäß-Chirurgie – Cardiovascular Surgery

Mehrzweckklemmen

Multi-Purpose-Clamps

Toothing DE BAKEY AIRAUMATA®

FB

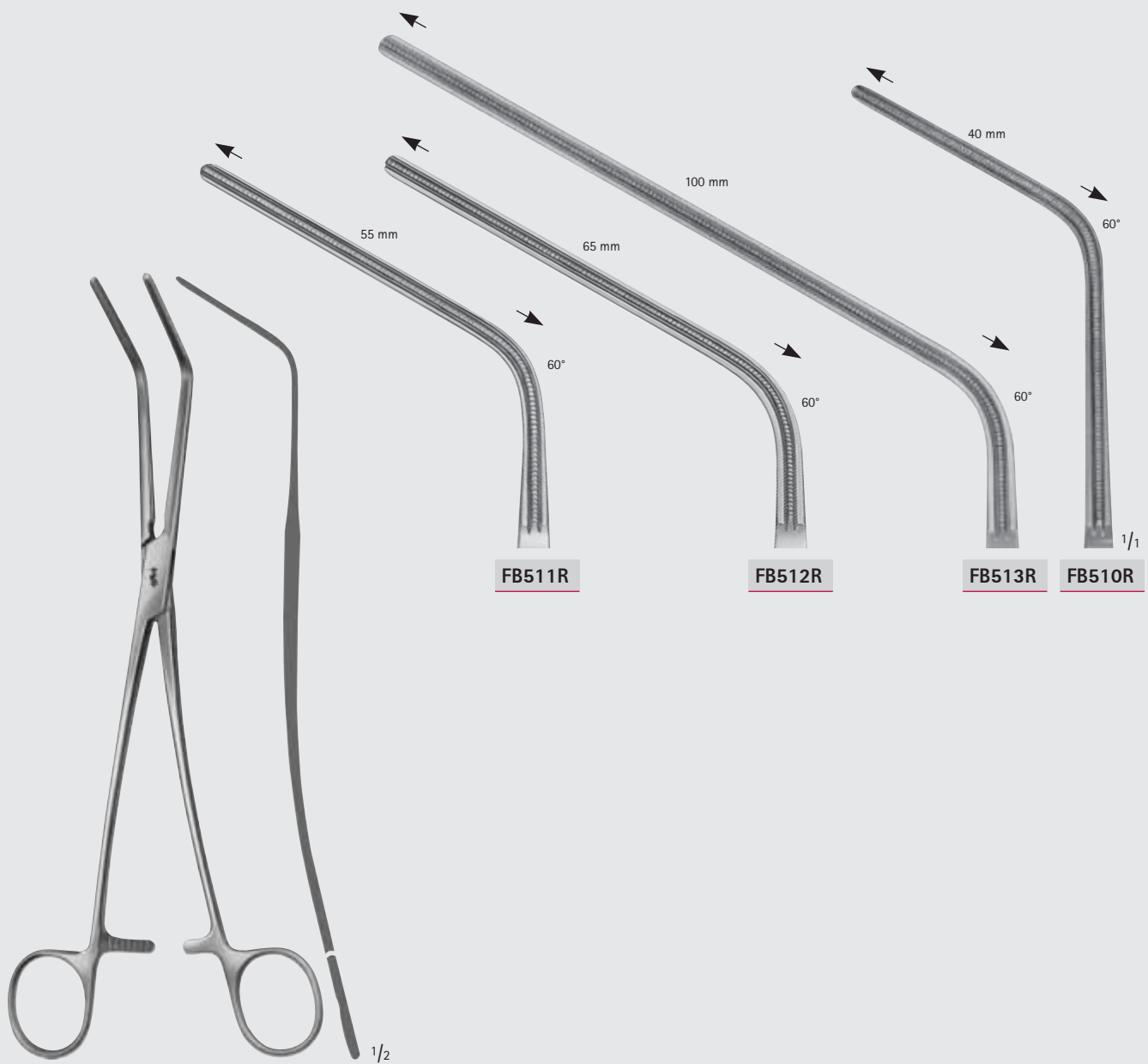

DE BAKEY

	FB511R	FB512R	FB513R	FB510R
Gesamtlänge:	230 mm	280 mm	305 mm	240 mm
Total Length:	9"	11"	12"	9 1/2"
Mauillänge:	85 mm	100 mm	135 mm	93 mm
Jaw length:	3 3/8"	4"	5 1/8"	3 3/4"



MILLIMETERS

Herz- und Gefäß-Chirurgie – Cardiovascular Surgery

Mehrweckklemmen
Multi-Purpose-Clamps

DE BAKEY Zahnung

ARAUMATA®

Toothing DE BAKEY

FB

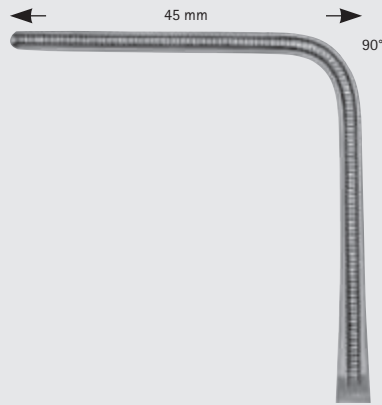

FB515R

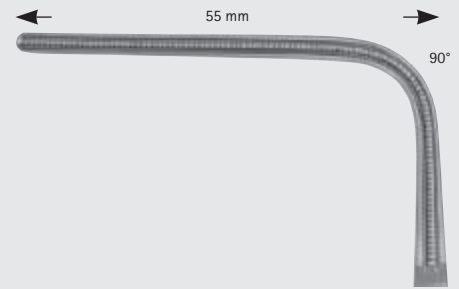

FB516R

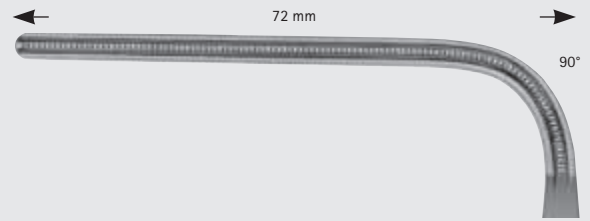

FB517R

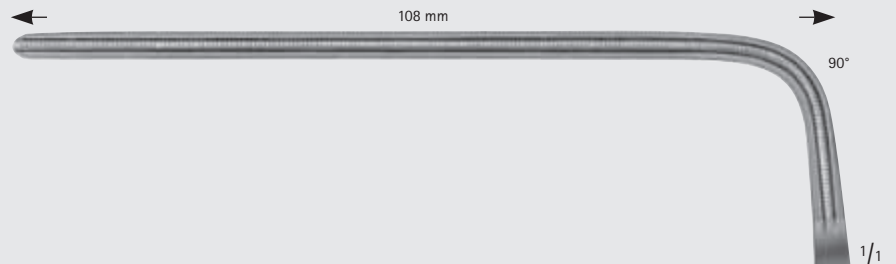

FB518R

DE BAKEY

	FB515R	FB516R	FB517R	FB518R
Gesamtlänge:	225 mm	210 mm	255 mm	275 mm
Total Length:	9"	8 1/4"	10"	10 3/4"
Maullänge:	93 mm	85 mm	92 mm	134 mm
Jaw length:	3 3/4"	3 3/8"	3 5/8"	5 1/4"



DE BAKEY Zahnung

Herz- und Gefäß-Chirurgie – Cardiovascular Surgery

Aortaklemmen

Toothing DE BAKEY

AIRAUMATA®

Ascending Aorta Cross Clamps

FB

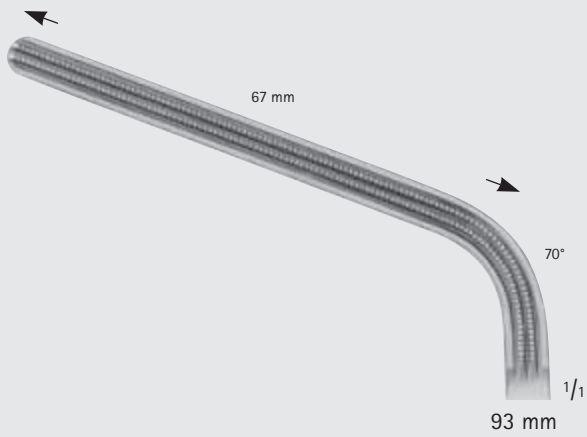

MORRIS

FB493R

175 mm, 7"

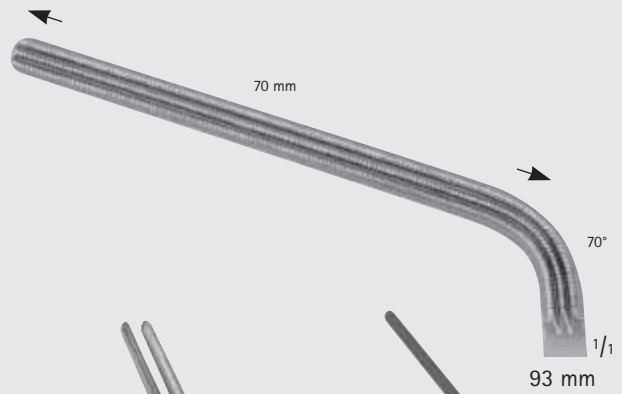

DE BAKY (MORRIS MODIF.)

FB494R

240 mm, 9"

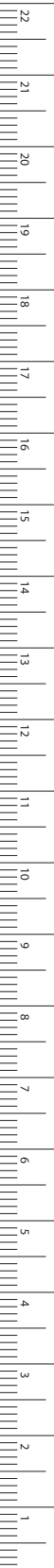

Herz- und Gefäß-Chirurgie – Cardiovascular Surgery

Bronchusklemmen

Bronchus Clamps

DE BAKEY Zahnung

APRAUMATA®

Toothing DE BAKEY

FB

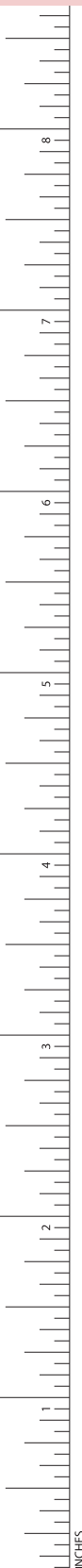

LEES

FB573R

220 mm, 8 3/4"



LEES

FB574R

245 mm, 9 3/4"



DE BAKEY Zahnung

Toothing DE BAKEY

ARAUMATA®

Herz- und Gefäß-Chirurgie – Cardiovascular Surgery

Aorta-Aneurysma-Klemmen

Aorta-Aneurysm-Clamps

FB

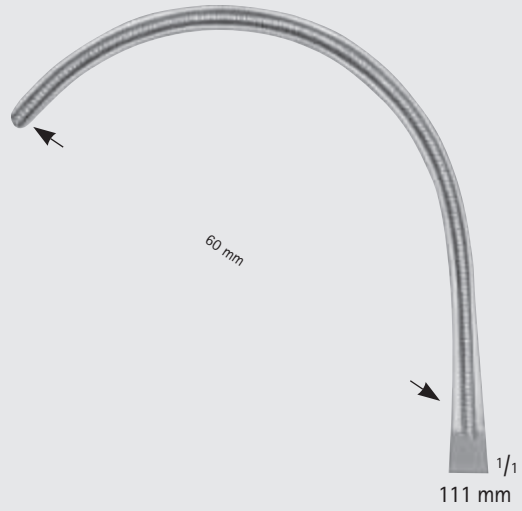
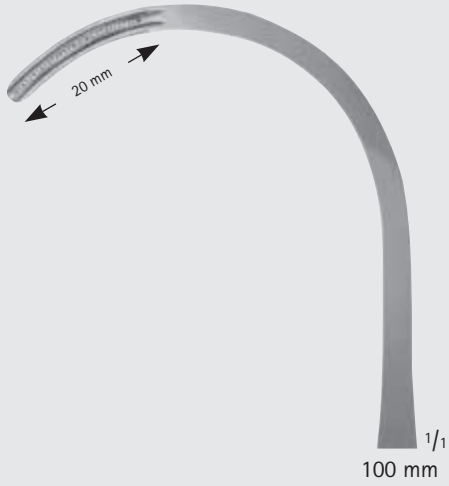

DE BAKEY (SEMB MODIF.)

FB482R

265 mm, 10 1/2"



DE BAKEY

FB481R

270 mm, 10 3/4"

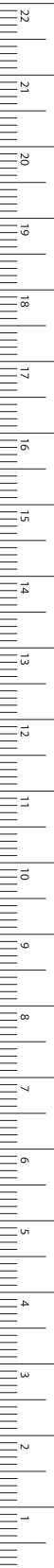

Herz- und Gefäß-Chirurgie – Cardiovascular Surgery

Aorta-Aneurysma-Klemmen

Aorta-Aneurysm-Clamps

DE BAKEY Zahnung

ARAUMATA®

Toothing DE BAKEY

FB

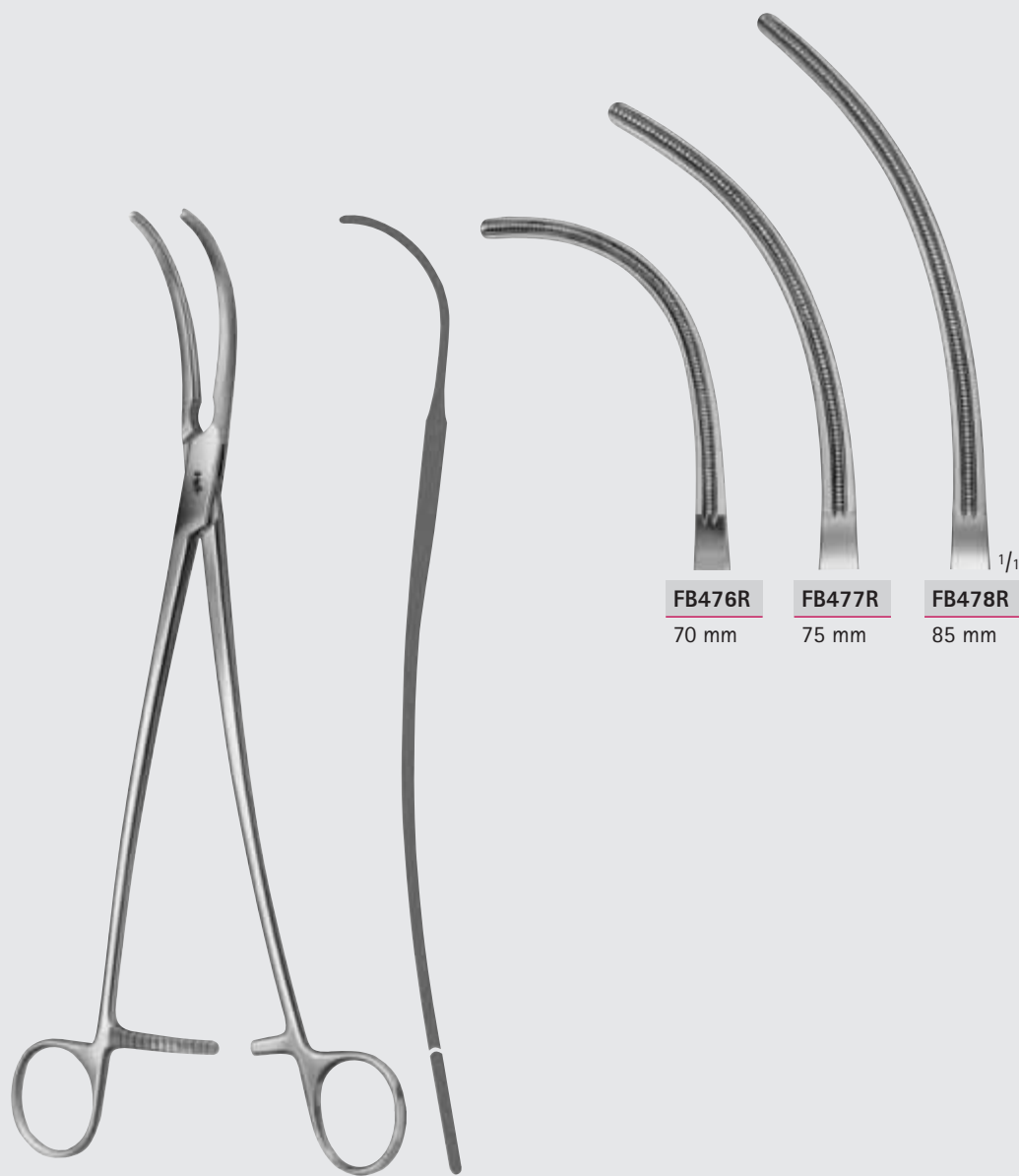

FB476R
70 mm

FB477R
75 mm

FB478R
85 mm

DE BAKEY

FB476R	255 mm	10"
FB477R	265 mm	10 1/2"
FB478R	280 mm	11"



DE BAKEY Zahnung



Toothing DE BAKEY

ARAUMATA[®]

Herz- und Gefäß-Chirurgie – Cardiovascular Surgery

Aorta-Aneurysma-Klemmen

Aorta-Aneurysm-Clamps

2:3 Zahnreihen
2:3 Teeth rows

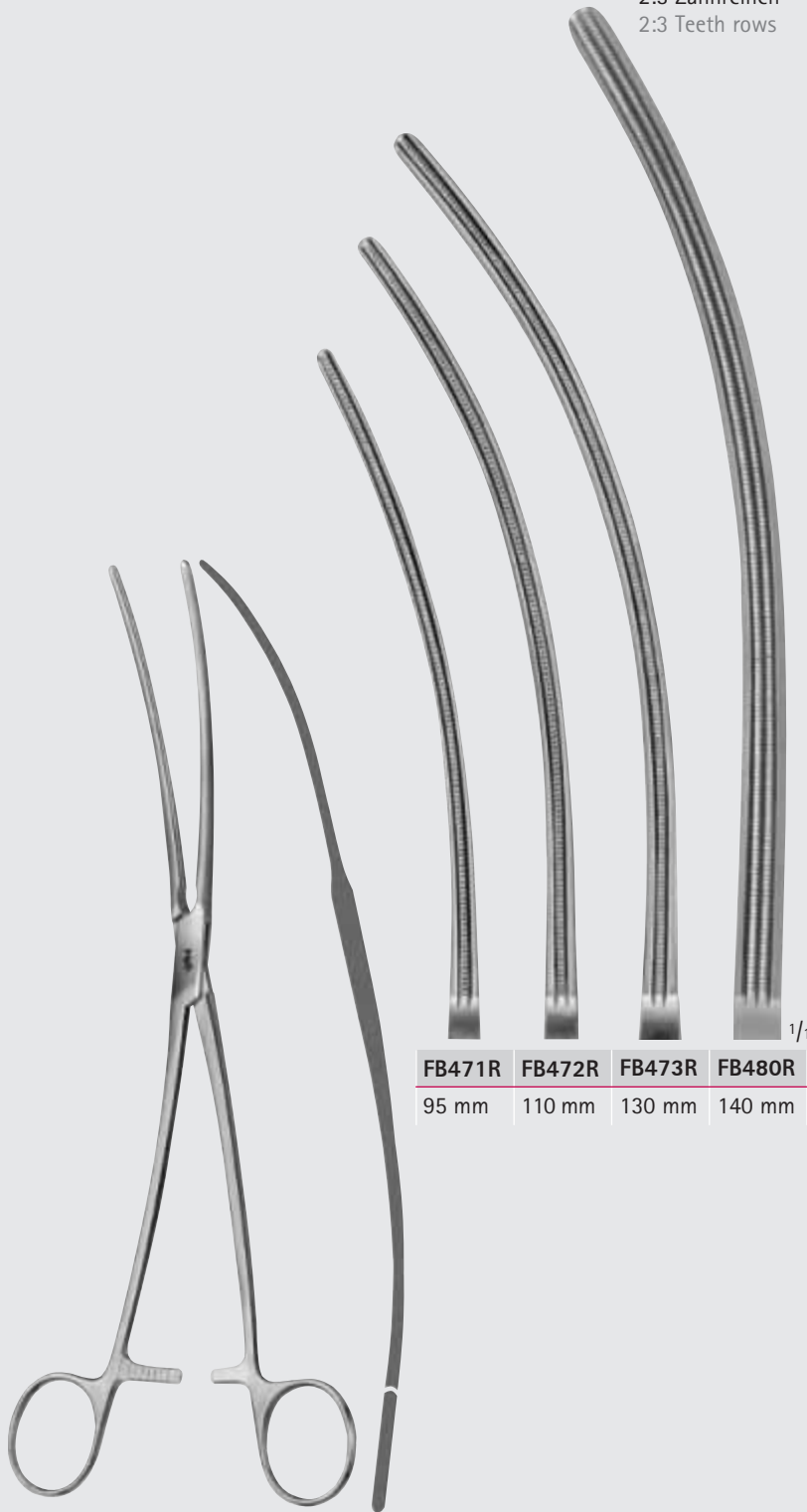

FB471R	FB472R	FB473R	FB480R
95 mm	110 mm	130 mm	140 mm

DE BAKEY

FB471R	250 mm	10"
FB472R	300 mm	12"
FB473R	315 mm	12 1/2"
FB480R	330 mm	13"

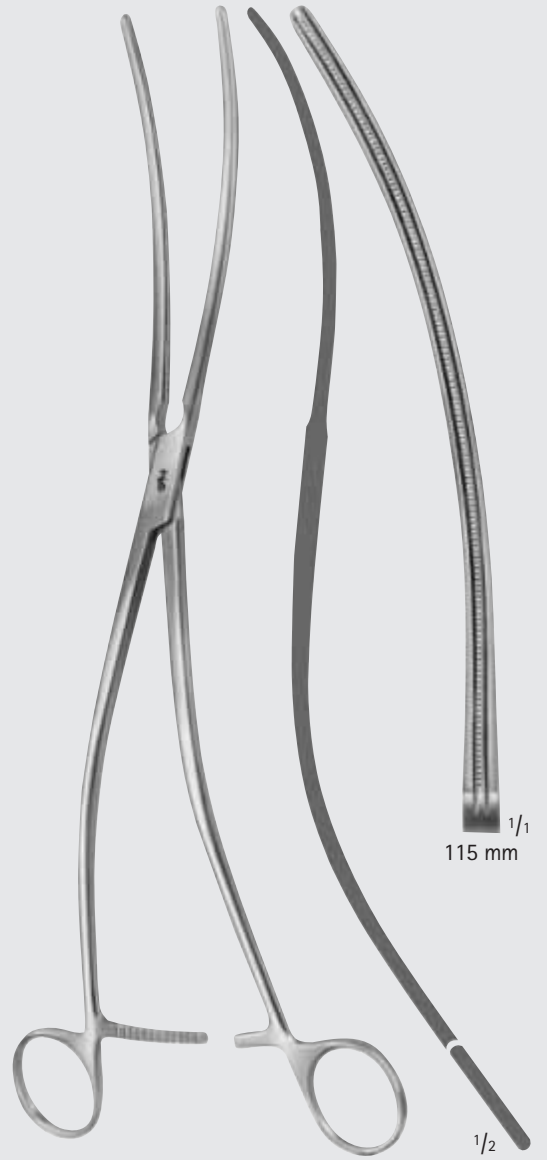

115 mm

DE BAKEY

FB475R
300 mm, 12"

FB

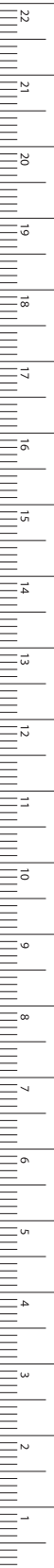

MILLIMETERS

Herz- und Gefäß-Chirurgie – Cardiovascular Surgery

Aortaklemmen

Aorta Clamps

DE BAKEY Zahnung

ARAUMATA®

Toothing DE BAKEY

FB

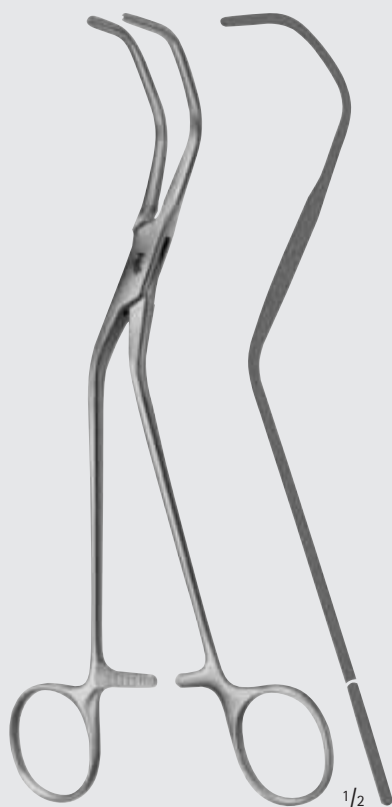
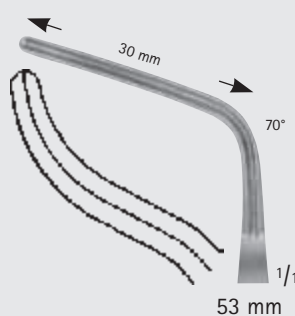

DIETRICH

FB525R

210 mm, 8 1/4"



SUBRAMANIAN (MODIF.)

FB578R

155 mm, 6"



DE BAKEY Zahnung

Toothing DE BAKEY

ARAUMATA®

Herz- und Gefäß-Chirurgie – Cardiovascular Surgery

Aortaklemmen

Aorta Clamps

FB

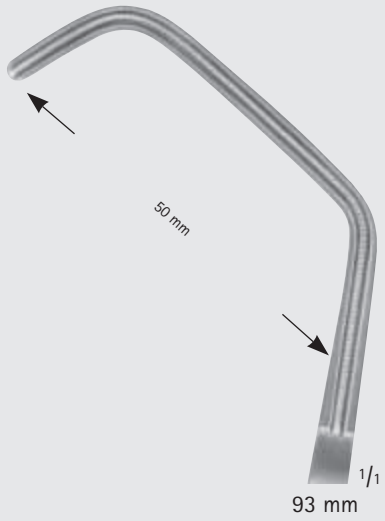

OCHSNER

FB495R

260 mm, 10 1/4"

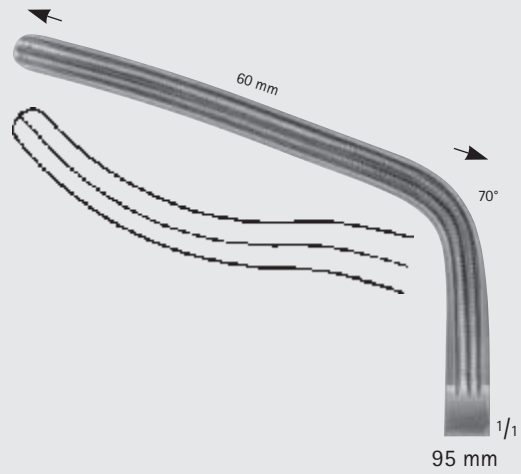

DE BAKY

FB576R

265 mm, 10 1/2"

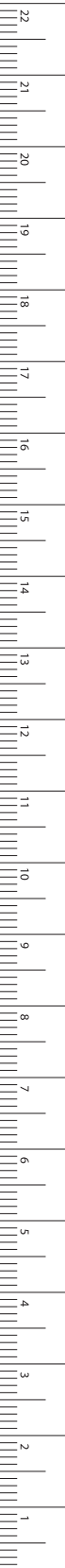

MILLIMETERS

Herz- und Gefäß-Chirurgie – Cardiovascular Surgery

Aorta-Anastomosenklemmen

Aorta-Anastomosis Clamps

DE BAKEY Zahnung

APRAUMATA®

Toothing DE BAKEY

FB

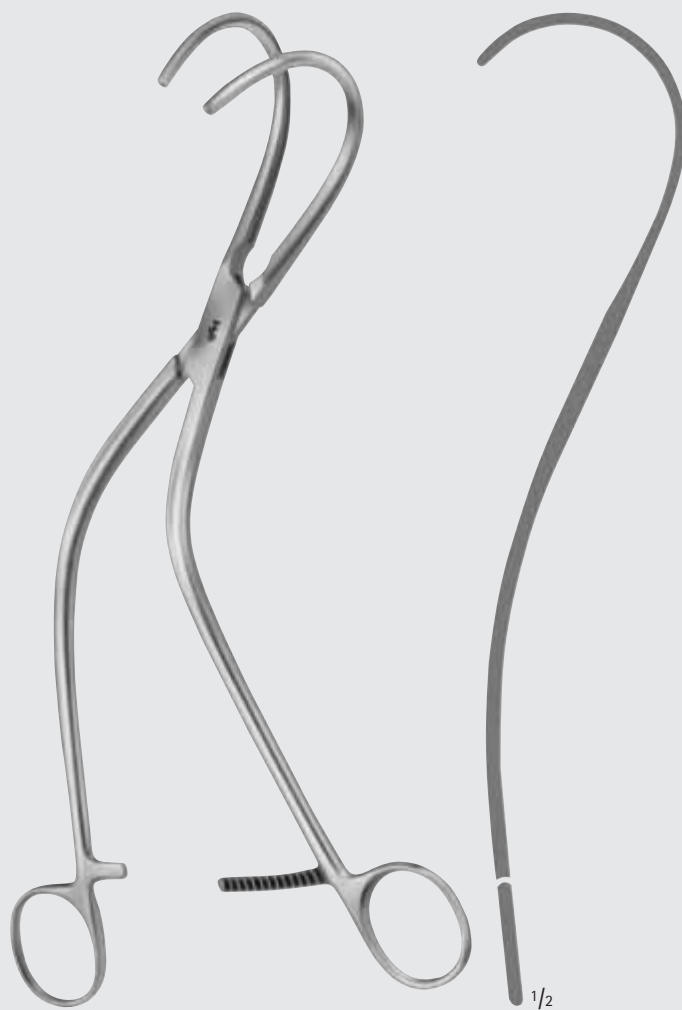
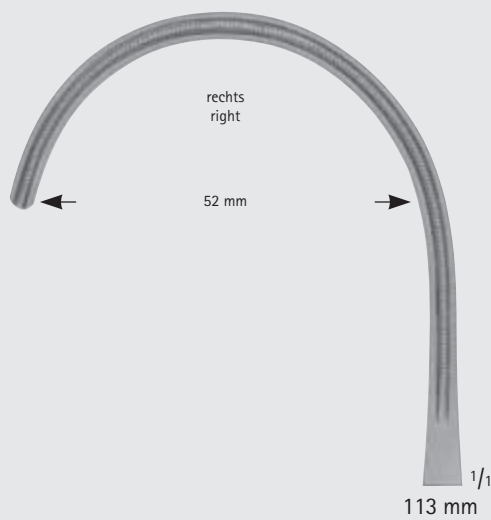
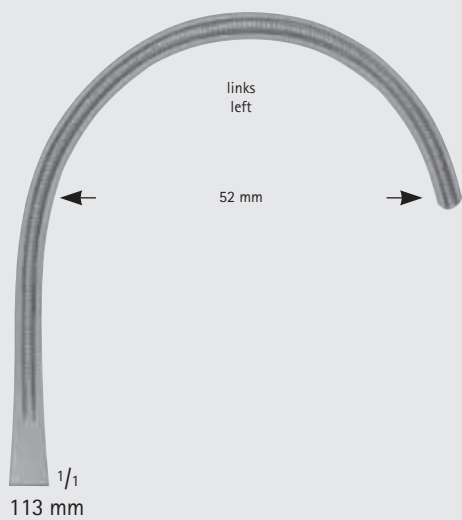

WEBER

FB488R

260 mm, 10 1/4"

WEBER

FB489R

260 mm, 10 1/4"



DE BAKEY Zahnung

Toothing DE BAKEY

ARAUMATA®

Herz- und Gefäß-Chirurgie – Cardiovascular Surgery

Aorta-Anastomosenklemmen

Aorta-Anastomosis Clamps

FB

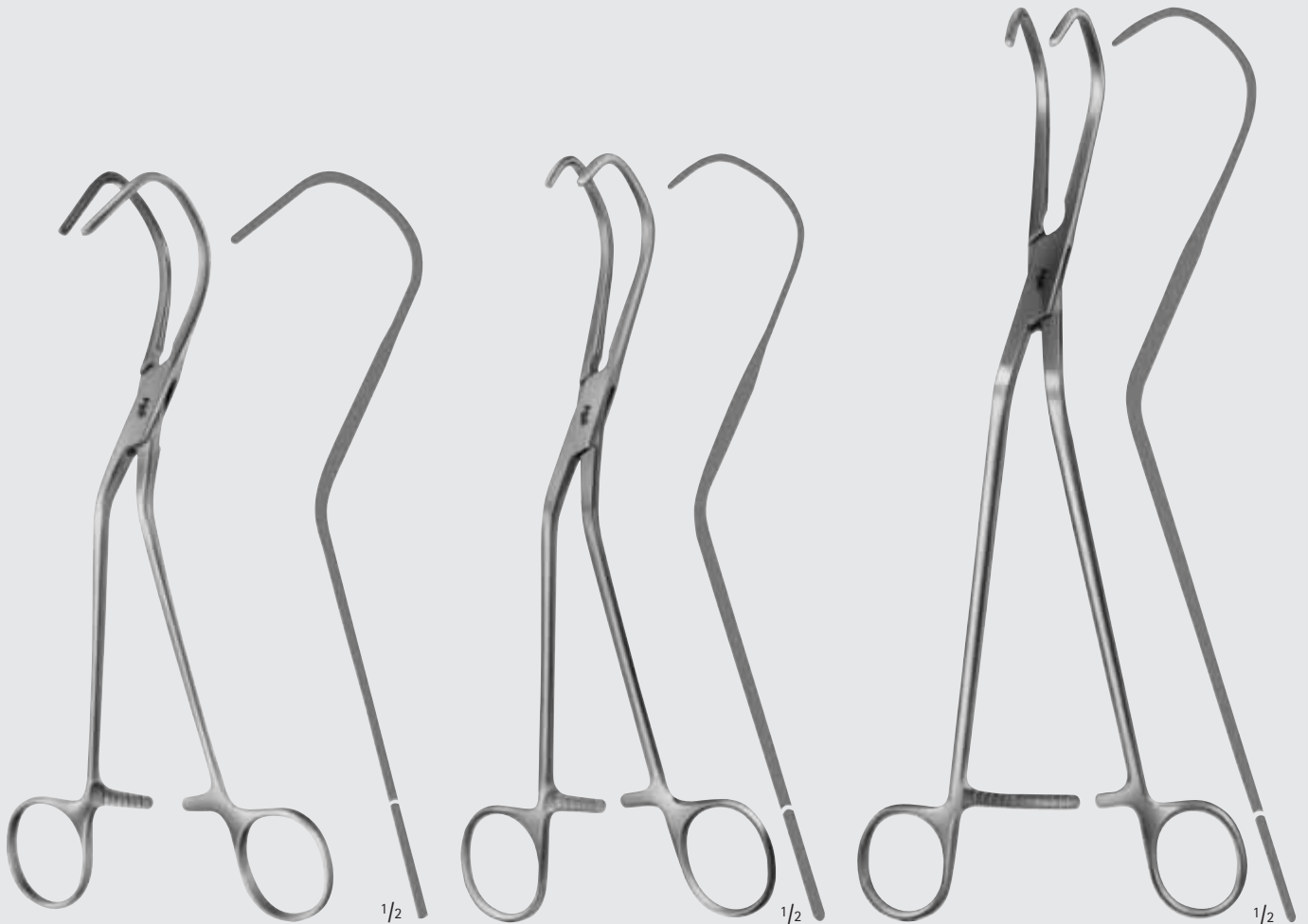
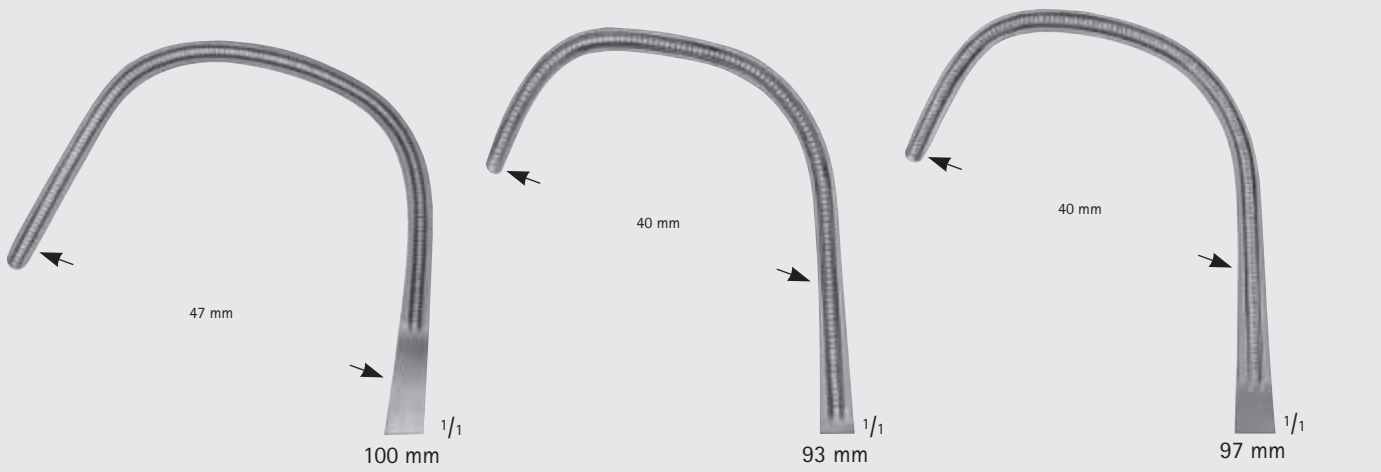

LAMBERT-KAY

FB492R

210 mm, 8 1/4"

LAMBERT-KAY

FB490R

215 mm, 8 1/2"

DE BAKEY (MOD. LAMBERT)

FB491R

255 mm, 10"



MILLIMETERS

Herz- und Gefäß-Chirurgie – Cardiovascular Surgery

Bulldogklemmen mit Ringgriffen
Ring Handle Bulldog Clamps

COOLEY Zahnung

ARAUMATA®

Toothing COOLEY

FB

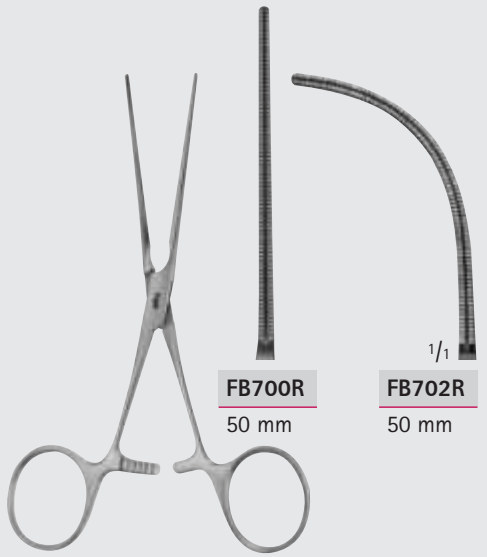

FB700R
50 mm

FB702R
50 mm

COOLEY

FB700R	125 mm	5"
FB702R	115 mm	4 1/2"

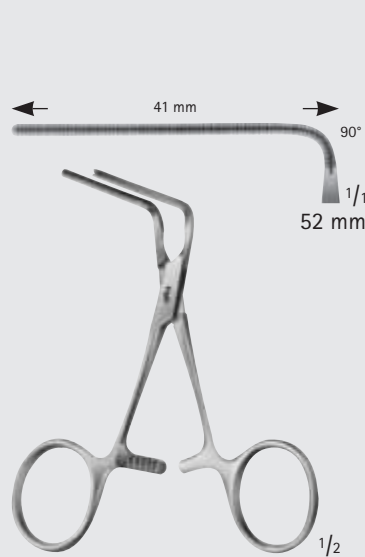

COOLEY

FB707R

100 mm, 4"

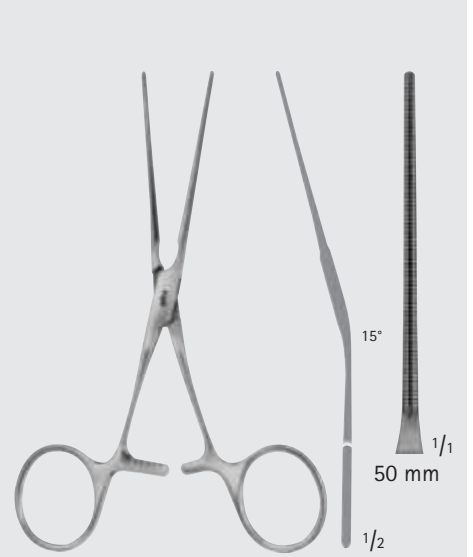

COOLEY

FB701R

125 mm, 5"

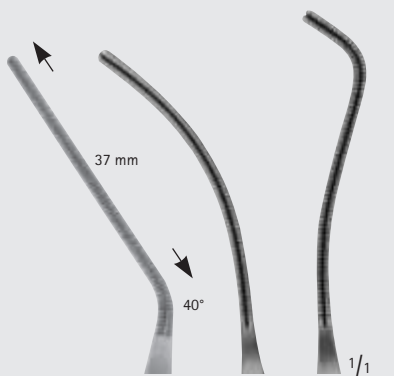

FB704R	FB703R	FB706R
50 mm	50 mm	52 mm

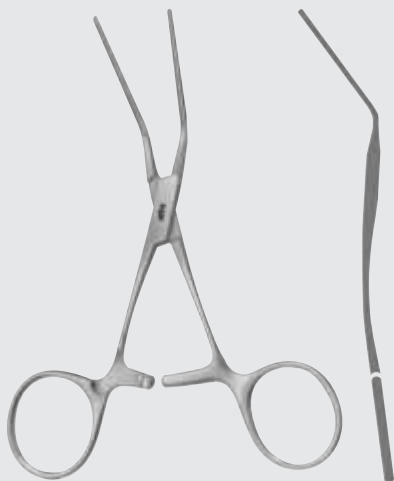

COOLEY

FB704R	120 mm	4 3/4"
FB703R	125 mm	5"
FB706R	125 mm	5"

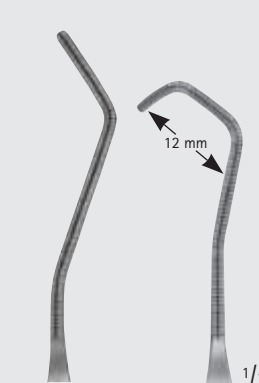

FB705R
50 mm

FB708R
50 mm

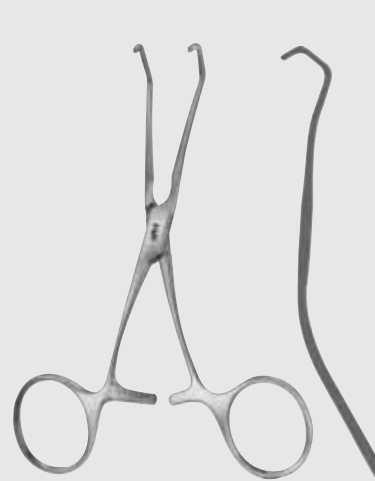

COOLEY

FB705R	120 mm	4 3/4"
FB708R	115 mm	4 1/2"



COOLEY Zahnung

Toothings COOLEY

ARAUMATA®

Herz- und Gefäß-Chirurgie – Cardiovascular Surgery

Bulldogklemmen mit Ringgriffen

Ring Handle Bulldog Clamps

FB

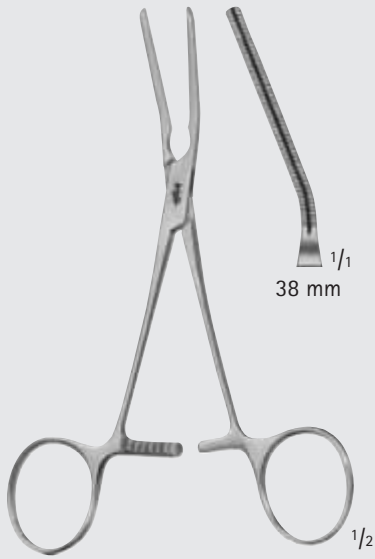

COOLEY

FB741R

145 mm, 5 3/4"



COOLEY

FB742R

140 mm, 5 1/2"

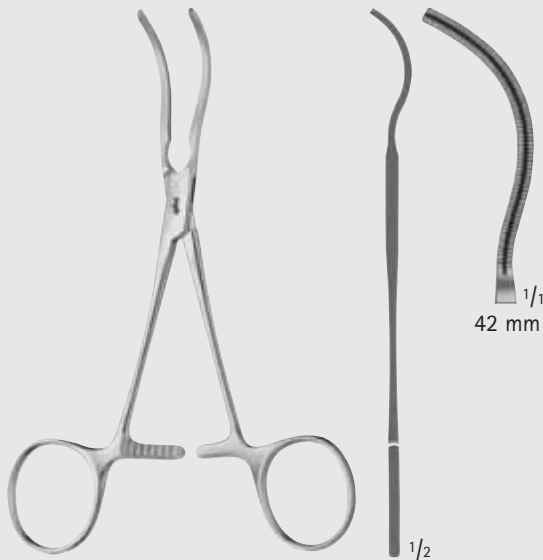

COOLEY

FB743R

145 mm, 5 3/4"



SATINSKY

MB613R

140 mm, 5 1/2"

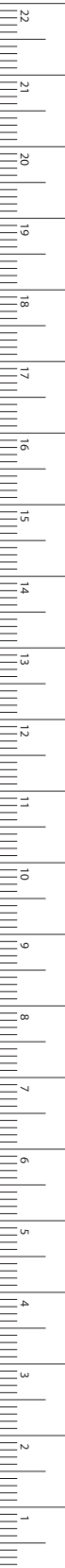

MILLIMETERS

Herz- und Gefäß-Chirurgie – Cardiovascular Surgery

Anastomosenklemmen, Kinder-Modelle

Anastomosis Clamps, Pediatric Patterns

COOLEY Zahnung

ARAUMATA®

Toothing COOLEY

FB

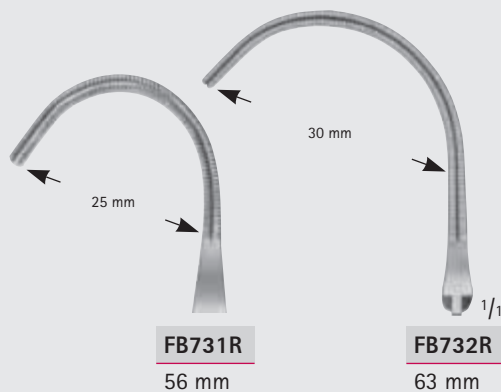

COOLEY-BECK

FB731R	150 mm	6"
FB732R	155 mm	6"

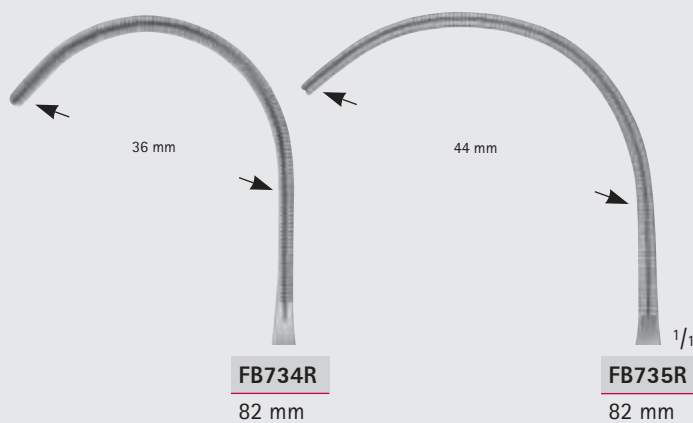

COOLEY

FB734R-FB735R	170 mm, 6 3/4"
----------------------	----------------



COOLEY Zahnung

Toothing COOLEY

ARAUMATA®

Herz- und Gefäß-Chirurgie – Cardiovascular Surgery

Anastomosenklemmen, Kinder-Modelle

Anastomosis Clamps, Pediatric Patterns

FB

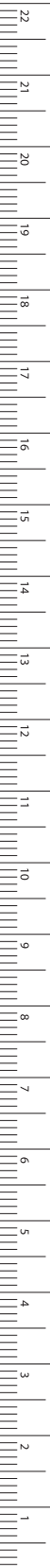

MILLIMETERS

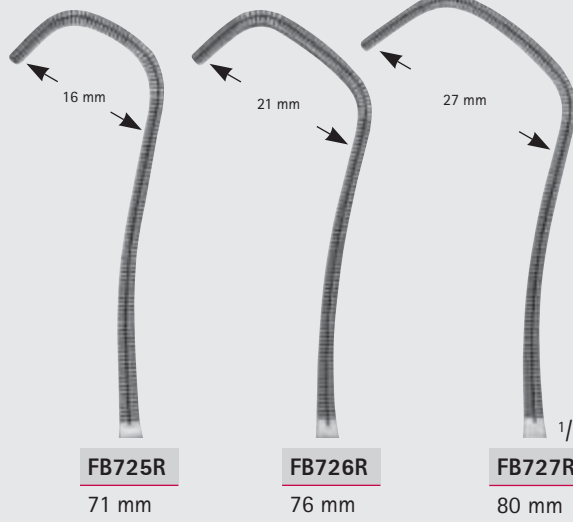

FB725R
71 mm

FB726R
76 mm

FB727R
80 mm

DERRA-COOLEY

FB725R	170 mm	6 3/4"
FB726R	175 mm	7"
FB727R	175 mm	7"

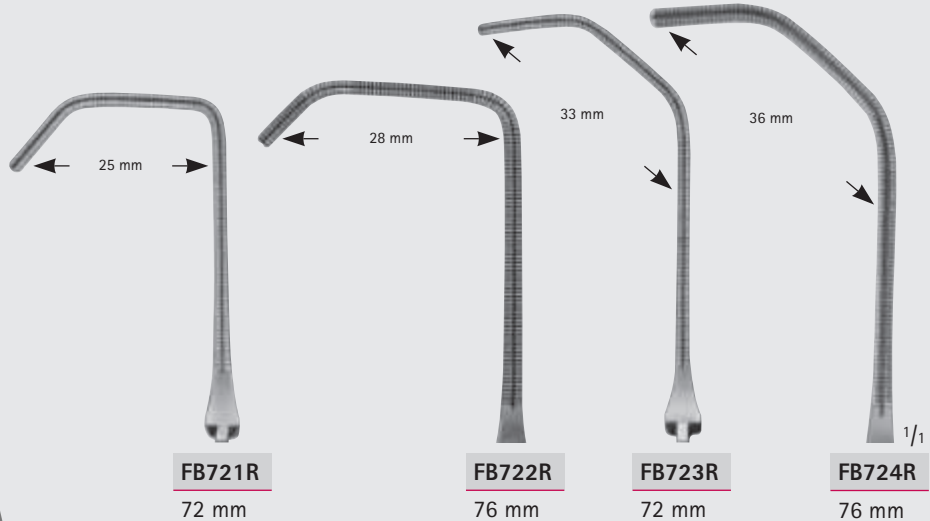

FB721R
72 mm

FB722R
76 mm

FB723R
72 mm

FB724R
76 mm

COOLEY

FB721R	165 mm	6 1/2"
FB722R	165 mm	6 1/2"
FB723R	175 mm	7"
FB724R	180 mm	7"

Herz- und Gefäß-Chirurgie – Cardiovascular Surgery

Mehrzweckklemmen, Kinder-Modelle
Multi-Purpose Clamps, Pediatric Patterns

COOLEY Zahnung

ARAIMATA®

Toothing COOLEY

FB

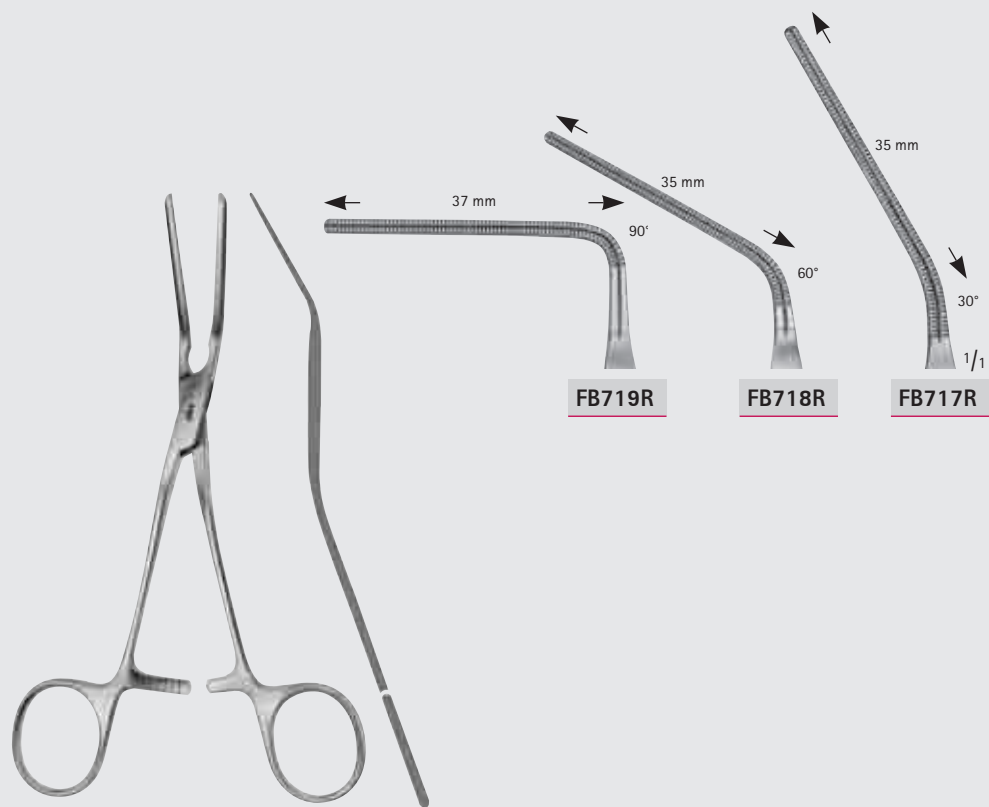

COOLEY

FB719R	150 mm	6"
FB718R	160 mm	6 1/4"
FB717R	165 mm	6 1/2"



COOLEY Zahnung

Toothings COOLEY

ARAUMATA®

Herz- und Gefäß-Chirurgie – Cardiovascular Surgery

Anastomosenklemmen, Mehrzweckklemmen
Anastomosis Clamps, Multi-Purpose Clamps

FB

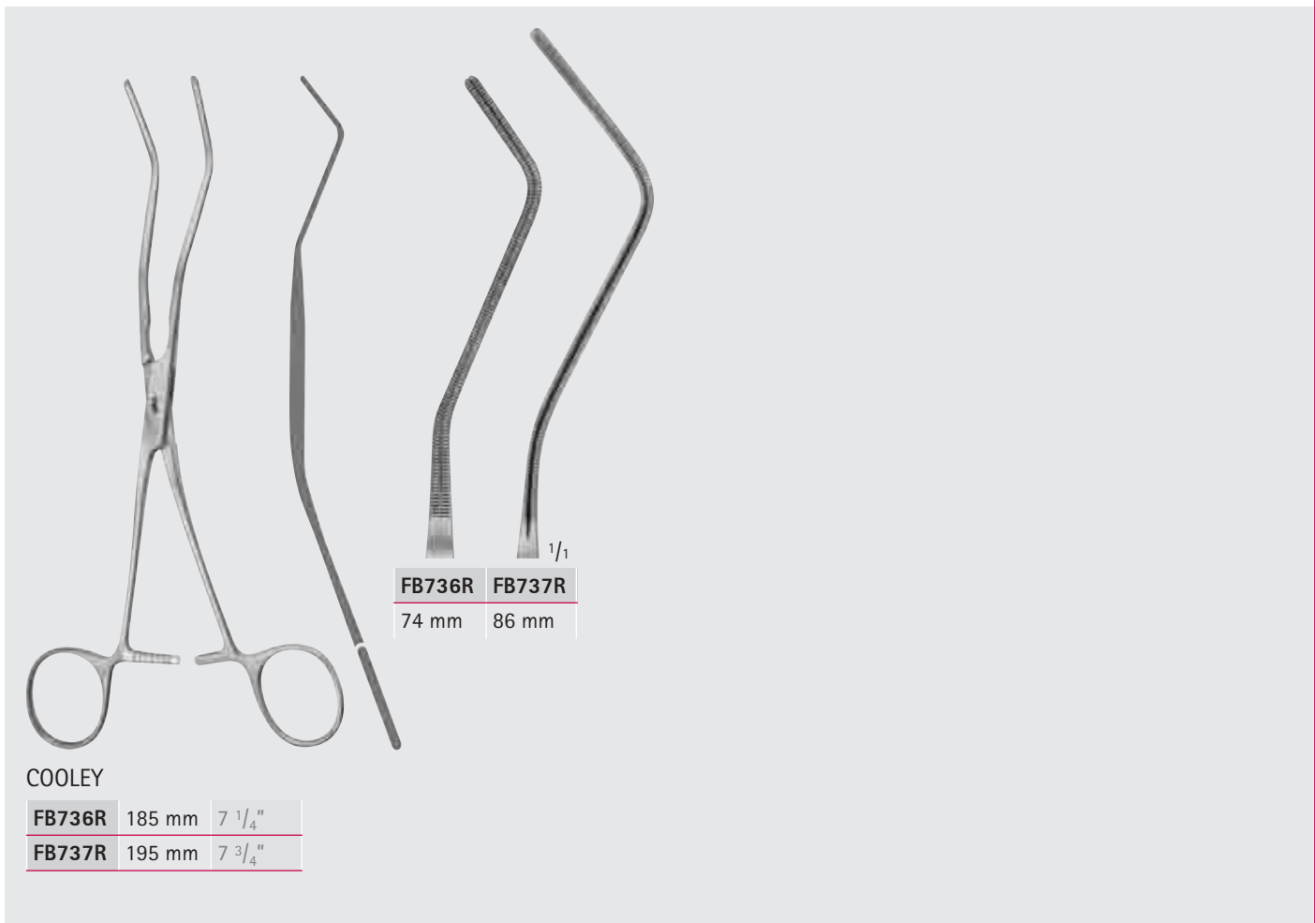
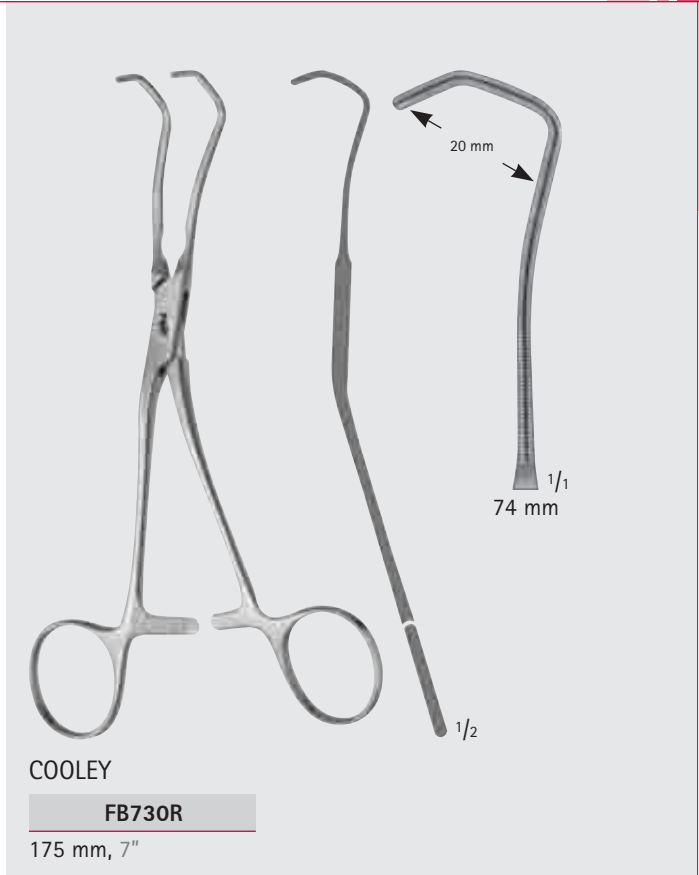
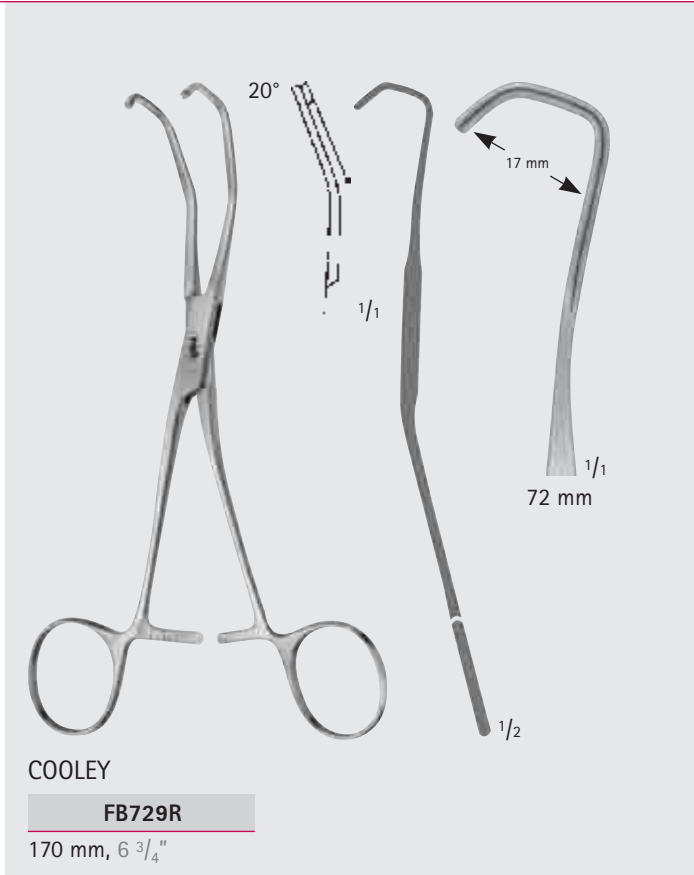

MILLIMETERS

Herz- und Gefäß-Chirurgie – Cardiovascular Surgery

Patent-Ductusklemmen, Coarctationsklemmen, Kinder-Modelle

Patent-Ductus Clamps, Coarctations Clamps, Pediatric Patterns

APRAUMATA®

COOLEY Zahnung

Toothing COOLEY

FB

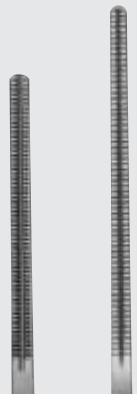

FB710R	FB712R
41 mm	52 mm



FB713R	FB715R
52 mm	63 mm

COOLEY

FB710R	160 mm	6 1/4"
FB712R	170 mm	6 3/4"
FB713R	180 mm	7"
FB715R	180 mm	7"

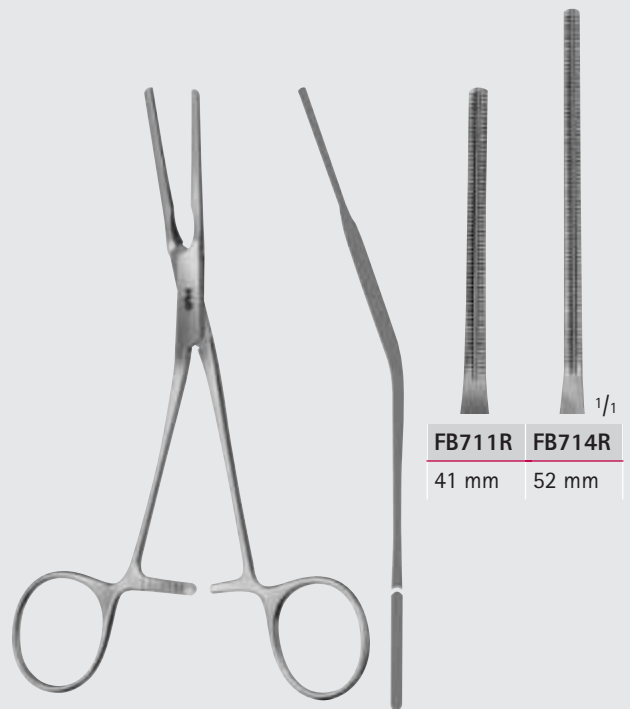

FB711R	FB714R
41 mm	52 mm

COOLEY

FB711R	160 mm	6 1/4"
FB714R	170 mm	6 3/4"



COOLEY Zahnung

Toothing COOLEY

ARAUMATA®

Herz- und Gefäß-Chirurgie – Cardiovascular Surgery

Patent-Ductusklemmen, Coarctationsklemmen, Kinder-Modelle
Patent-Ductus Clamps, Coarctations Clamps, Pediatric Patterns

FB

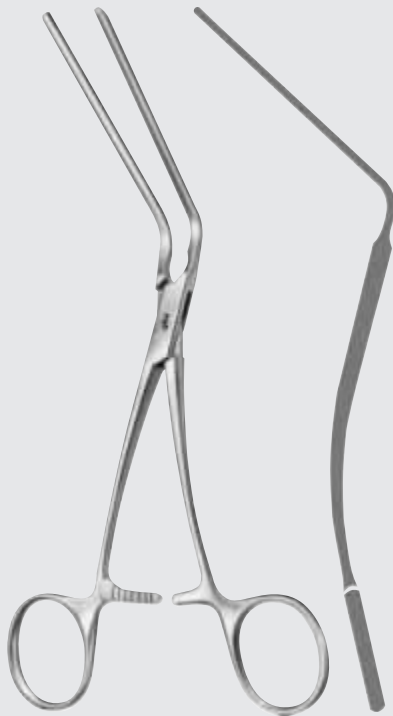
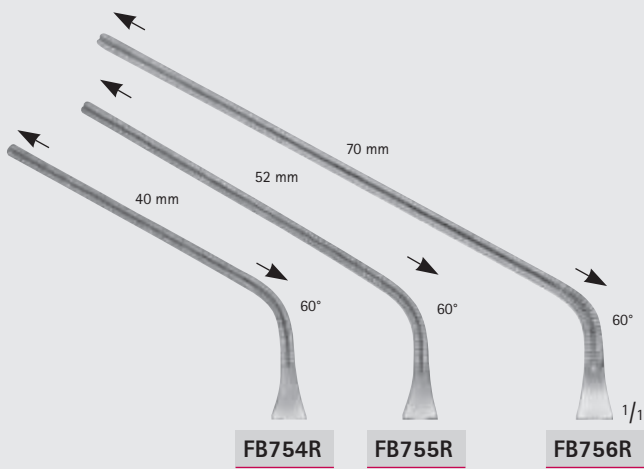

COOLEY

FB754R	165 mm	6 1/2"
FB755R	170 mm	6 3/4"
FB756R	185 mm	7 1/4"

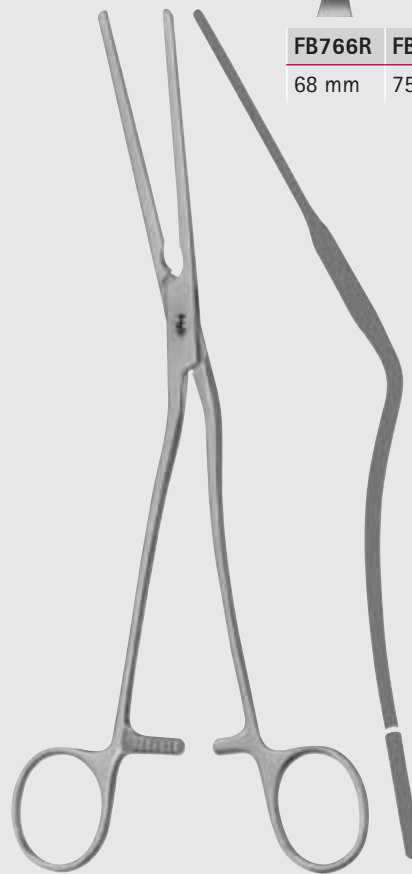
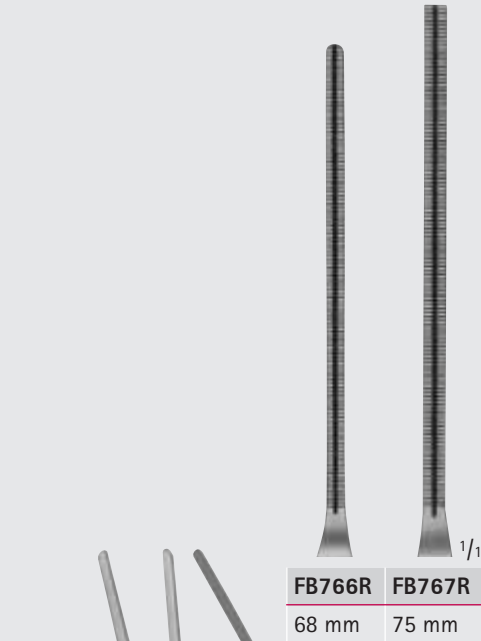

FB766R	225 mm	9"
FB767R	270 mm	10 3/4"

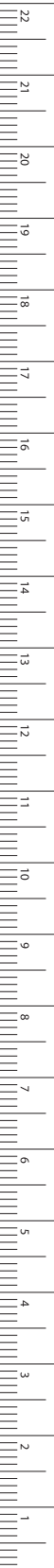

MILLIMETERS

Herz- und Gefäß-Chirurgie – Cardiovascular Surgery

Anastomosenklemmen, Mehrzweckklemmen
Anastomosis Clamps, Multi-Purpose Clamps

COOLEY Zahnung

APRAUMATA®

Toothing COOLEY

FB

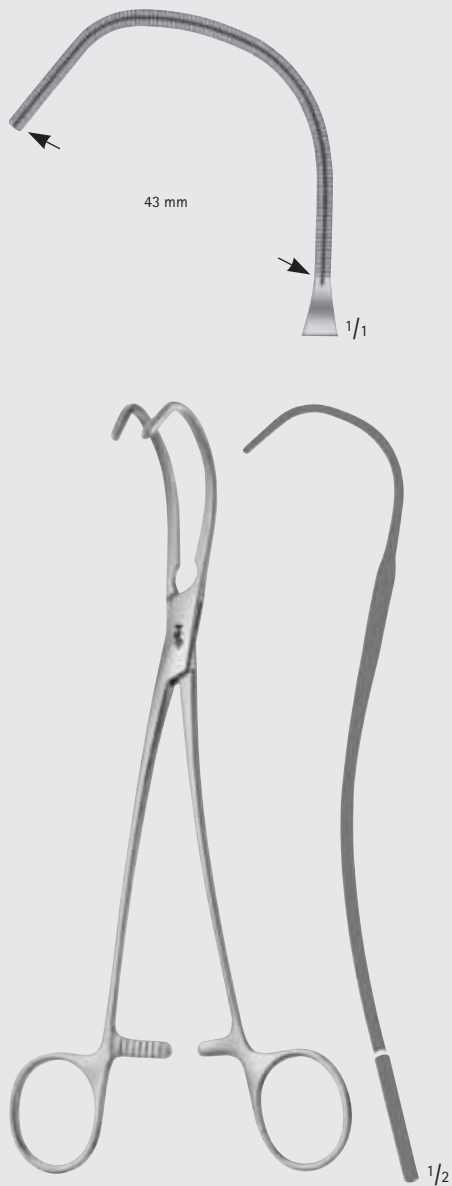

LEITZ

FB795R

205 mm, 8"

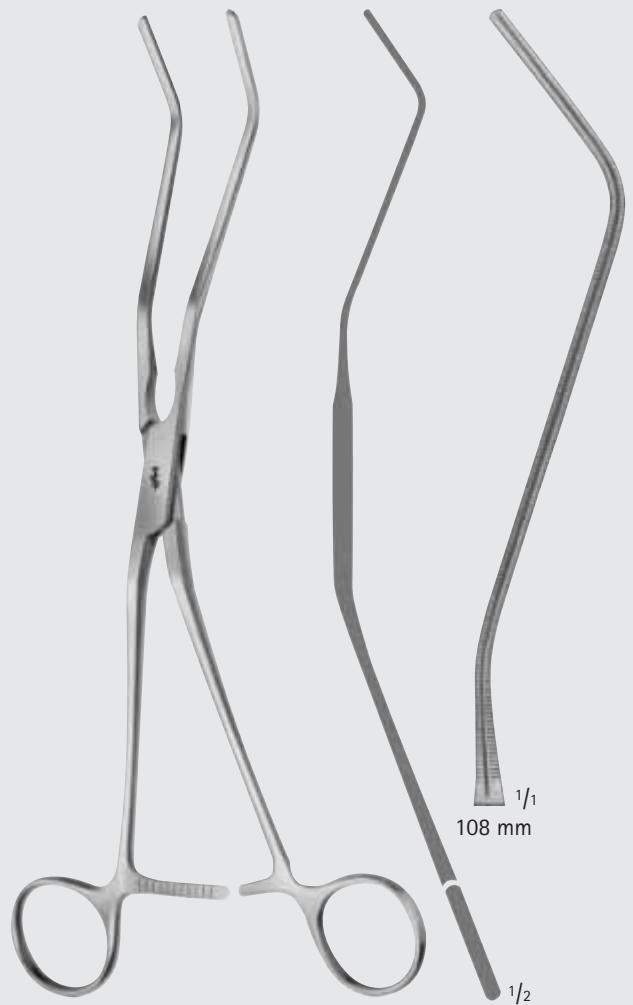

COOLEY

FB738R

260 mm, 10 3/4"



COOLEY Zahnung

Toothing COOLEY

APRAUMATA®

Herz- und Gefäß-Chirurgie – Cardiovascular Surgery

Anastomosenklemmen

Anastomosis Clamps

FB

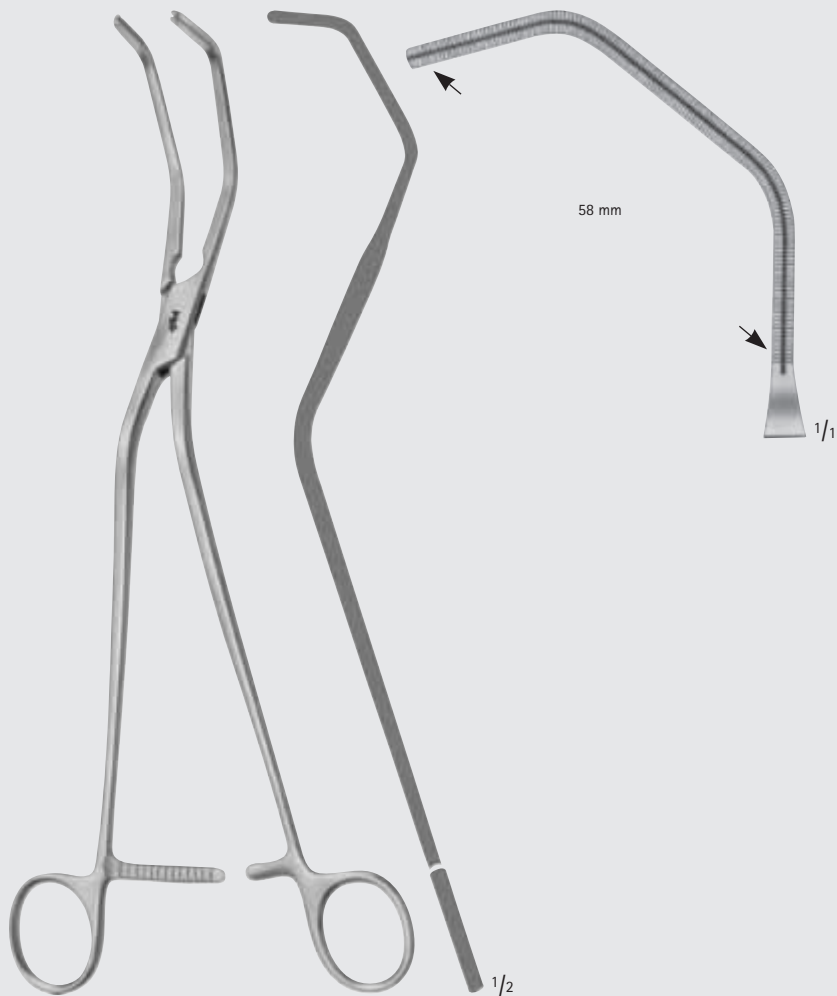

COOLEY

FB773R

260 mm, 10 1/4"



Herz- und Gefäß-Chirurgie – Cardiovascular Surgery

Anastomosenklemmen

Anastomosis Clamps

COOLEY Zahnung

APRAUMATA®

Toothing COOLEY

FB

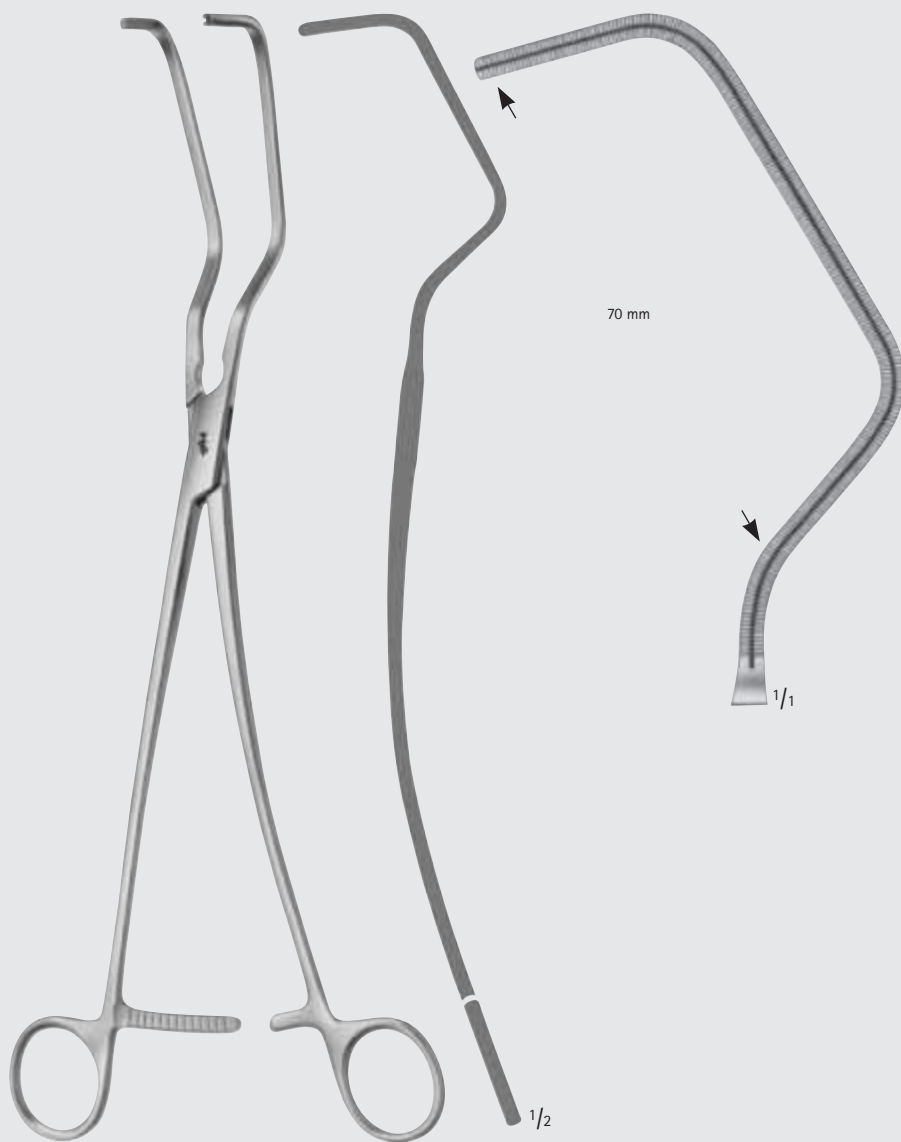

PARRY-COOLEY

FB775R

295 mm, 11 3/4"



COOLEY Zahnung

Toothing COOLEY

ARAUMATA®

Herz- und Gefäß-Chirurgie – Cardiovascular Surgery

Anastomosenklemmen

Anastomosis Clamps

FB

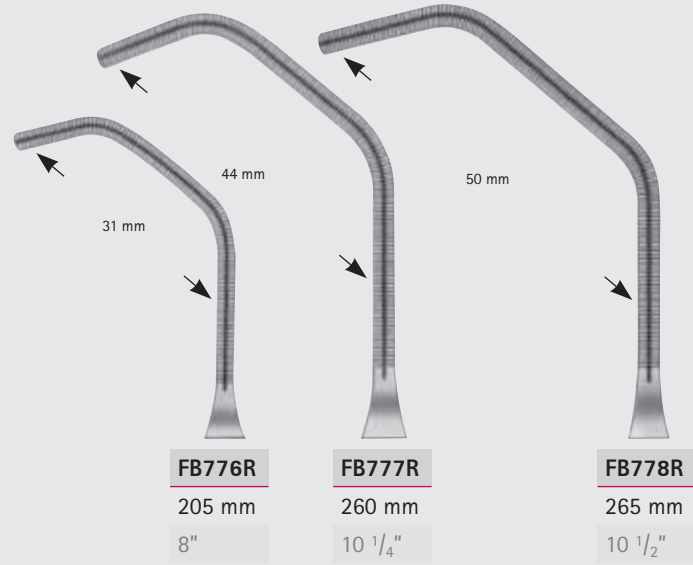

COOLEY

FB776R-FB780R

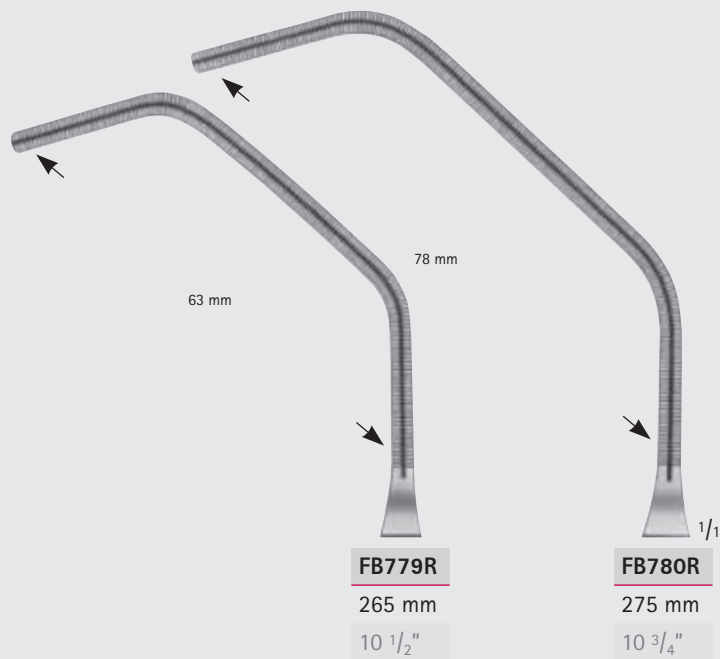

MILLIMETERS

Herz- und Gefäß-Chirurgie – Cardiovascular Surgery

Aortaklemme
Aorta Clamp

COOLEY Zahnung

ARAUMATA®

Toothing COOLEY

FB

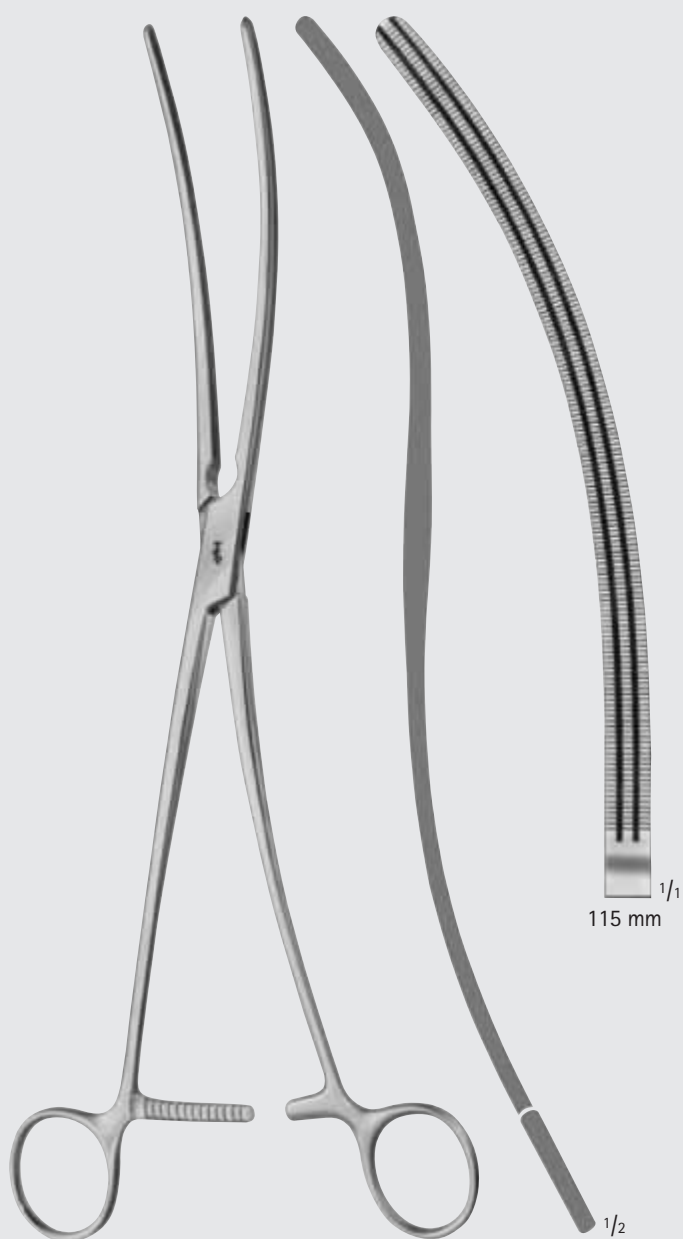

COOLEY

FB764R

320 mm, 12 3/4"



COOLEY Zahnung

Toothings COOLEY

ARAUMATA®

Herz- und Gefäß-Chirurgie – Cardiovascular Surgery

Mehrweckklemme
Multi-Purpose Clamp

FB



COOLEY

FB765R

285 mm, 11 1/4"

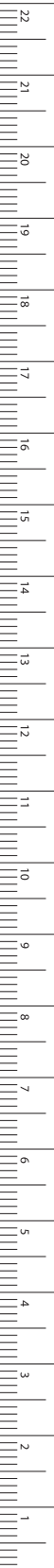

MILLIMETERS

Herz- und Gefäß-Chirurgie – Cardiovascular Surgery

Mehrzweckklemmen
Multi-Purpose Clamps

DE BAKEY Zahnung

APRAUMATA®

Toothing DE BAKEY

FB

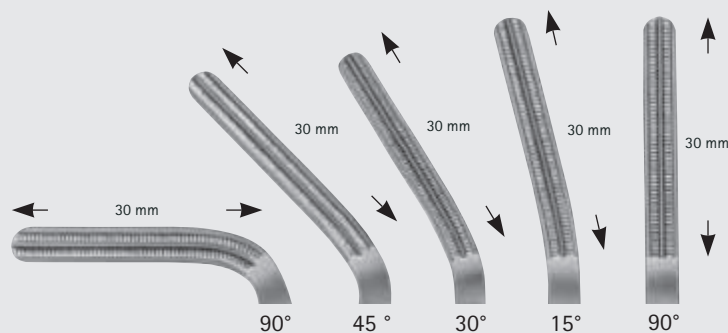

FC304R	FC303R	FC302R	FC301R	FC300R
130 mm	145 mm	150 mm	150 mm	150 mm
5 1/8"	5 3/4"	6"	6"	6"

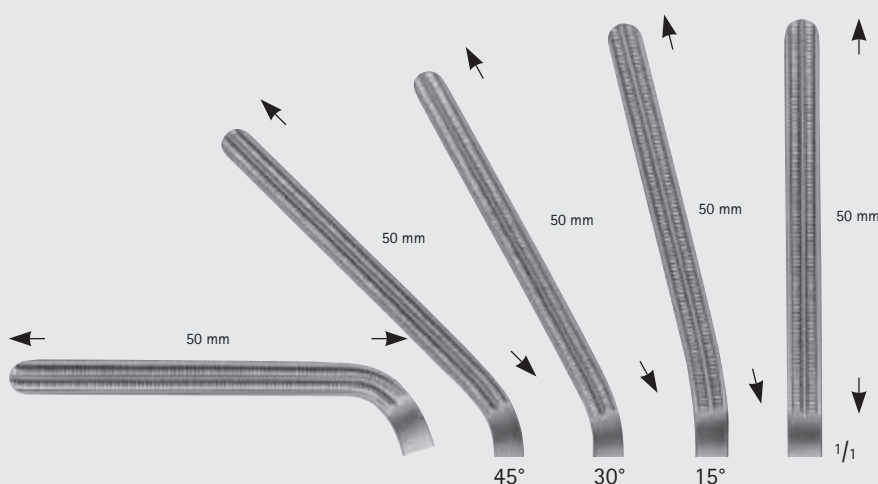

FC314R	FC313R	FC312R	FC311R	FC310R
135 mm	160 mm	170 mm	170 mm	170 mm
5 1/4"	6 1/4"	6 3/4"	6 3/4"	6 3/4"

FC300R-FC314R



DE BAKEY Zahnung

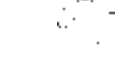

Toothings DE BAKEY

ARAUMATA®

Herz- und Gefäß-Chirurgie – Cardiovascular Surgery

Gewebe- und Organfasszangen

Tissue- and Organ Grasping Forceps

FB

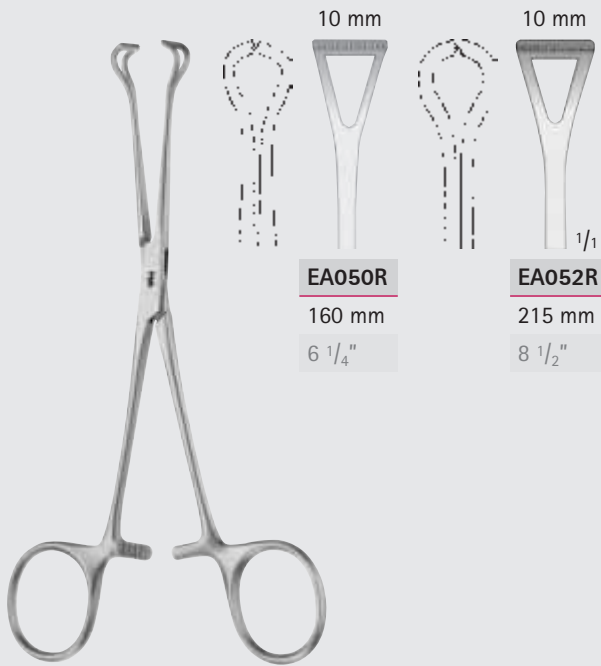

EA050R

160 mm

6 1/4"

EA052R

215 mm

8 1/2"

BABCOCK

EA050R-EA052R



BABCOCK

FB936R

220 mm, 8 3/4"



BABCOCK

MD470

240 mm, 9 1/2"

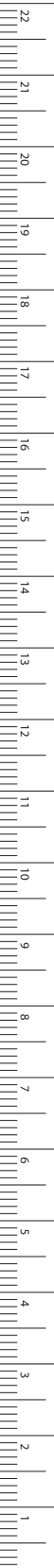

MILLIMETERS

Herz- und Gefäß-Chirurgie – Cardiovascular Surgery

Gewebe- und Organfasszangen

Tissue- and Organ Grasping Forceps

DE BAKEY Zahnung



APRAUMATA®

Toothing DE BAKEY

FB

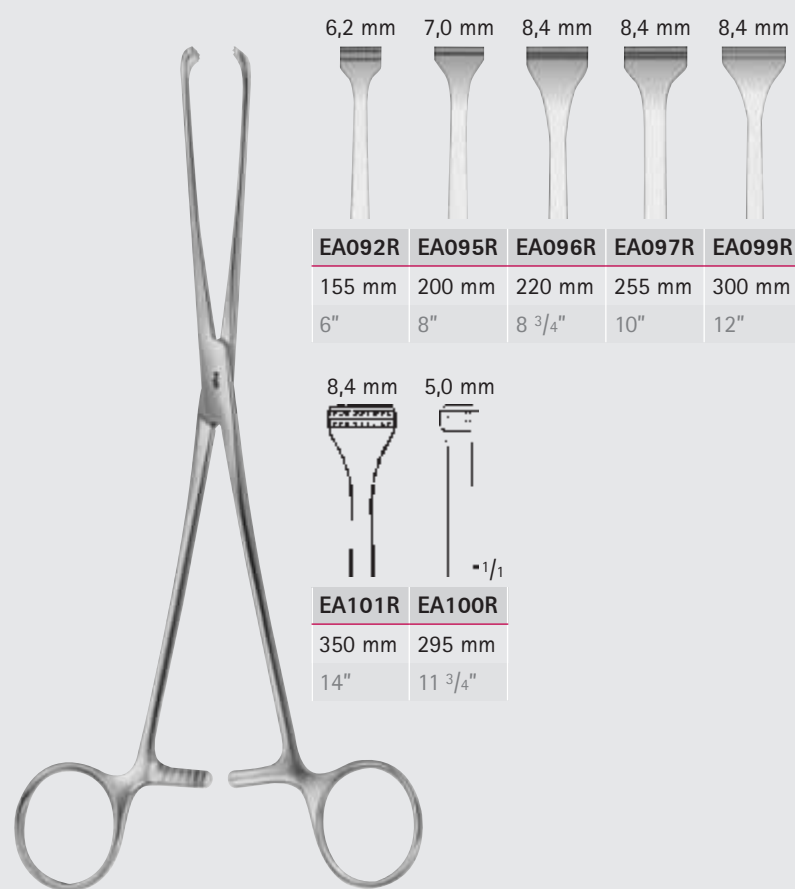

6,2 mm	7,0 mm	8,4 mm	8,4 mm	8,4 mm
EA092R	EA095R	EA096R	EA097R	EA099R
155 mm	200 mm	220 mm	255 mm	300 mm
6"	8"	8 3/4"	10"	12"

8,4 mm	5,0 mm
EA101R	EA100R
350 mm	295 mm
14"	11 3/4"

ALLIS
EA092R-EA101R



ALLIS
EA095R

besonders fein
very delicate
200 mm, 8"



DE BAKEY Zahnung

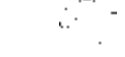

Toothing DE BAKEY

APRAUMATA®

Herz- und Gefäß-Chirurgie – Cardiovascular Surgery

Gewebe- und Organfasszangen

Tissue- and Organ Grasping Forceps

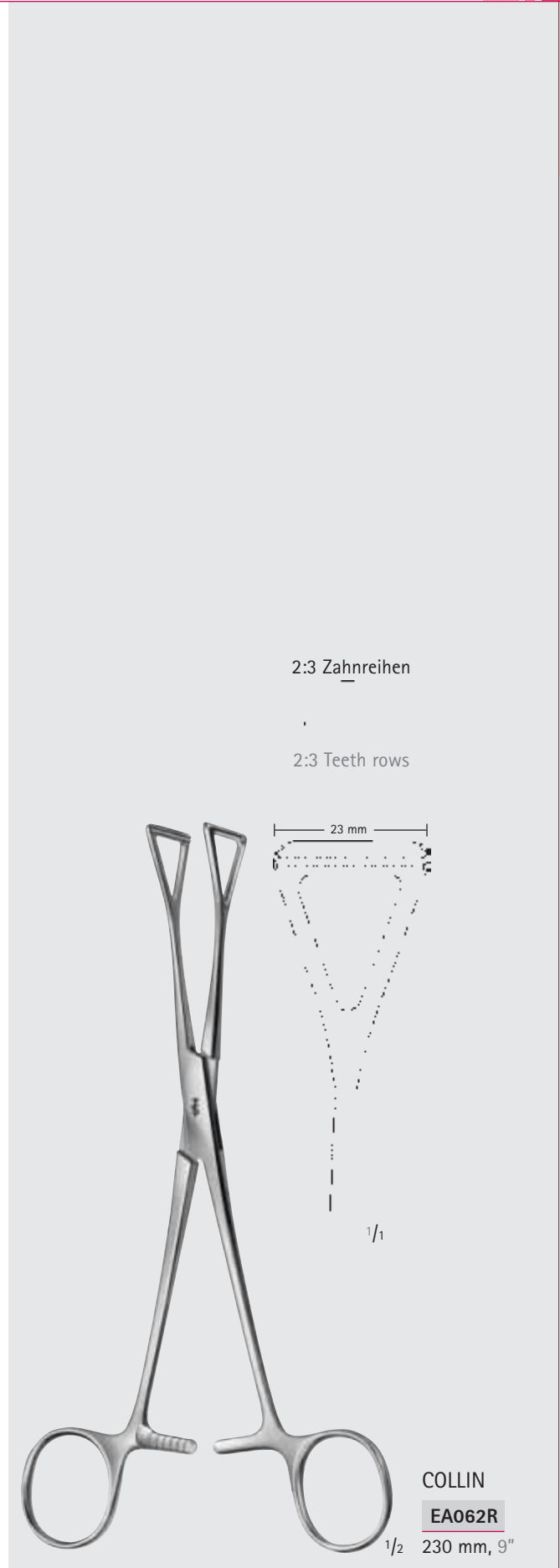
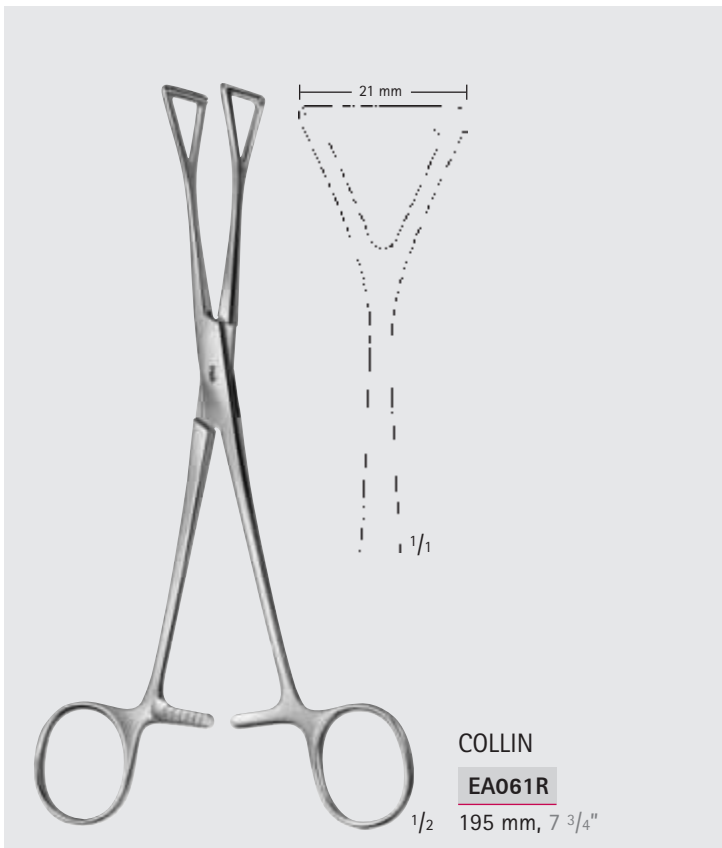
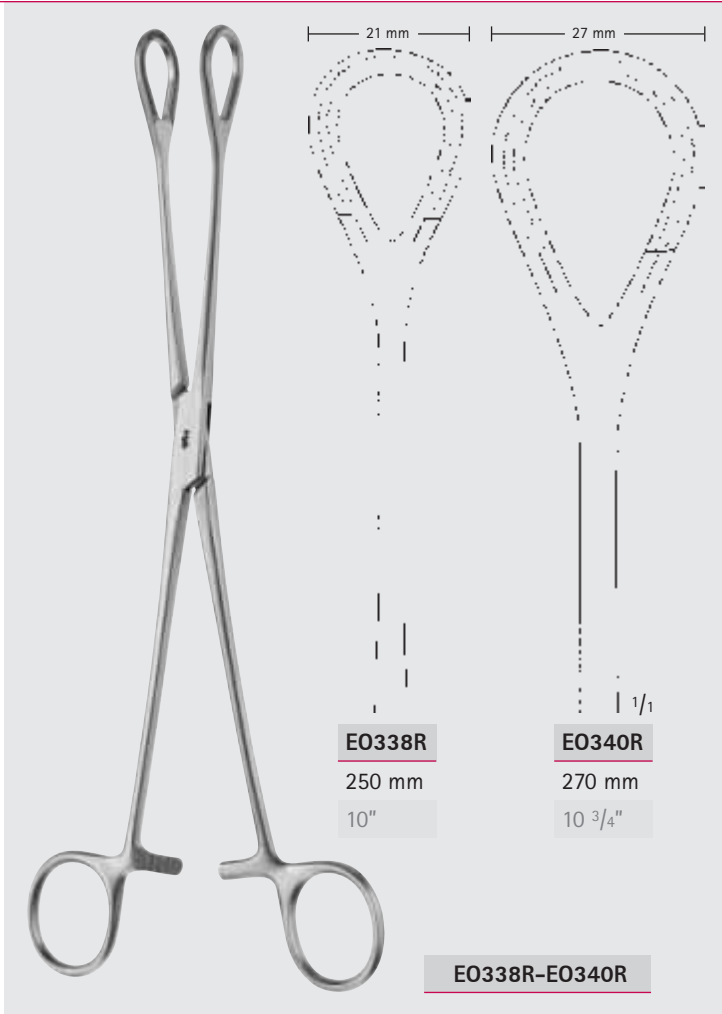

FB

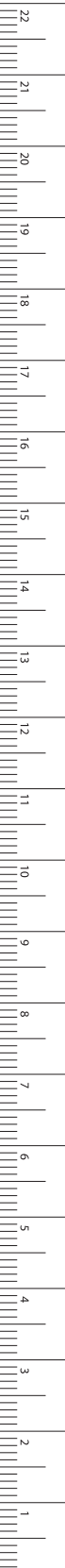

Herz- und Gefäß-Chirurgie – Cardiovascular Surgery

Lungenfazzangen, -pinzetten

Lung Grasping Forceps

Weitere Gewebefazzangen siehe Rubrik EA

Weitere Ligaturklemmen siehe Rubrik BJ

Further tissue grasping forceps see section EA

Further ligature forceps see section BJ



WILLIAMS

EA028R

160 mm, 6 1/4"

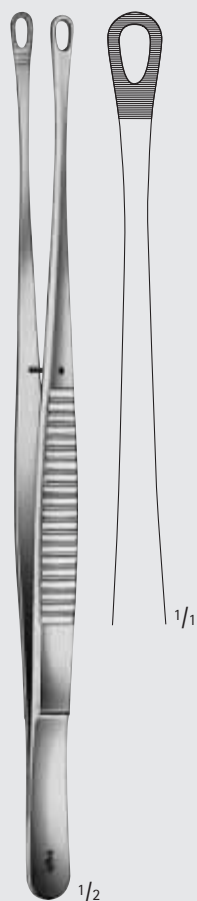

TUTTLE

BD801R

230 mm, 9"

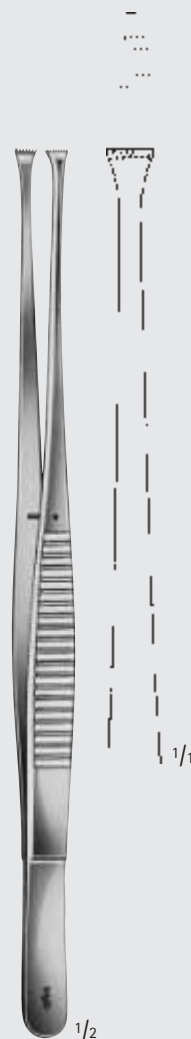

NELSON

BD802R

230 mm, 9"

FB





Herz- und Gefäß-Chirurgie – Cardiovascular Surgery
 Lungenfasszangen
 Lung Grasping Forceps

FB

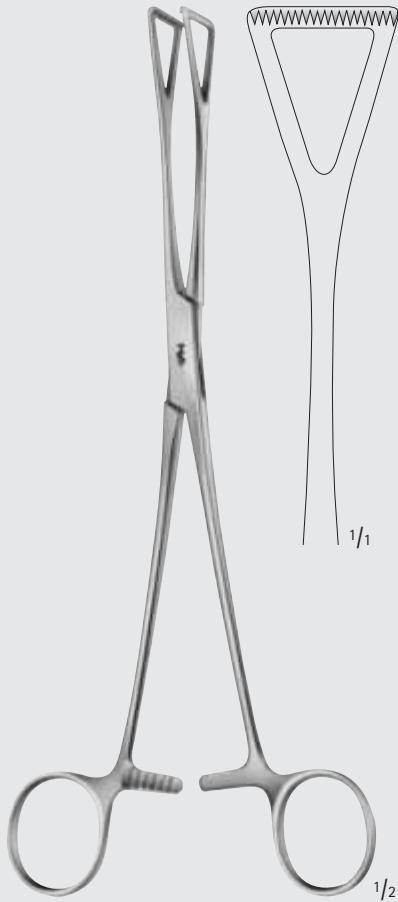
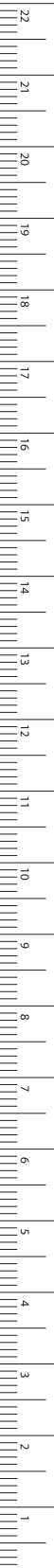

DUVAL

FB930R

$1/2$ 230 mm, 9"

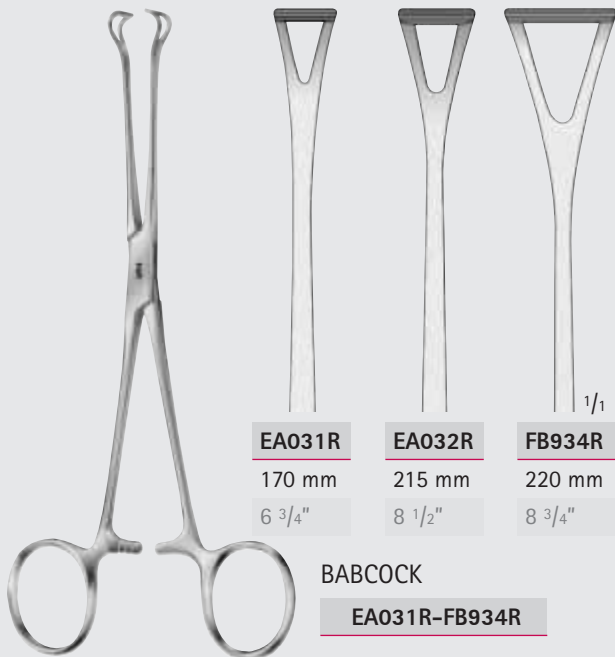

EA031R

170 mm

6 $3/4$ "

EA032R

215 mm

8 $1/2$ "

FB934R

220 mm

8 $3/4$ "

BABCOCK

EA031R-FB934R

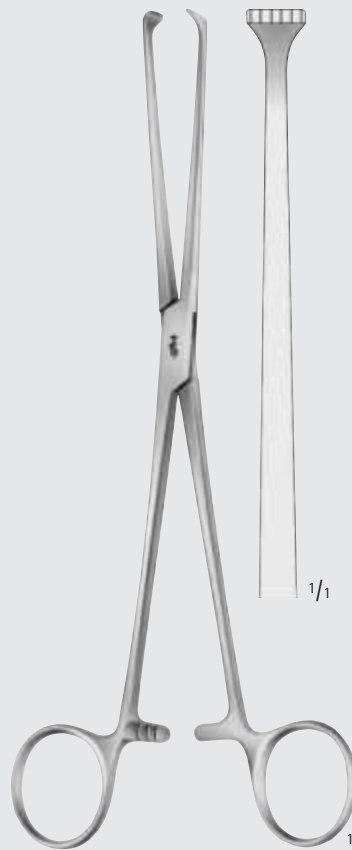

ALLIS

FB938R

$1/2$ 220 mm, 8 $3/4$ "

MILLIMETERS

Herz- und Gefäß-Chirurgie – Cardiovascular Surgery

Präparier- und Ligaturklemmen

Dissecting- and Ligature Forceps

FB

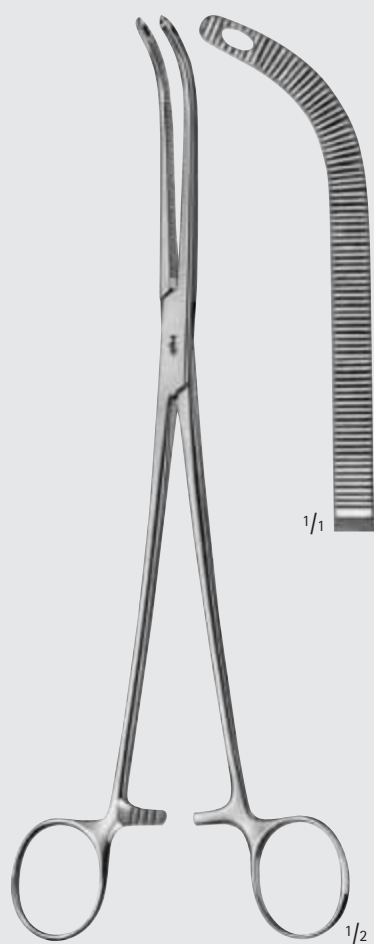

FINOCHIETTO

BJ052R

245 mm, 9 3/4"

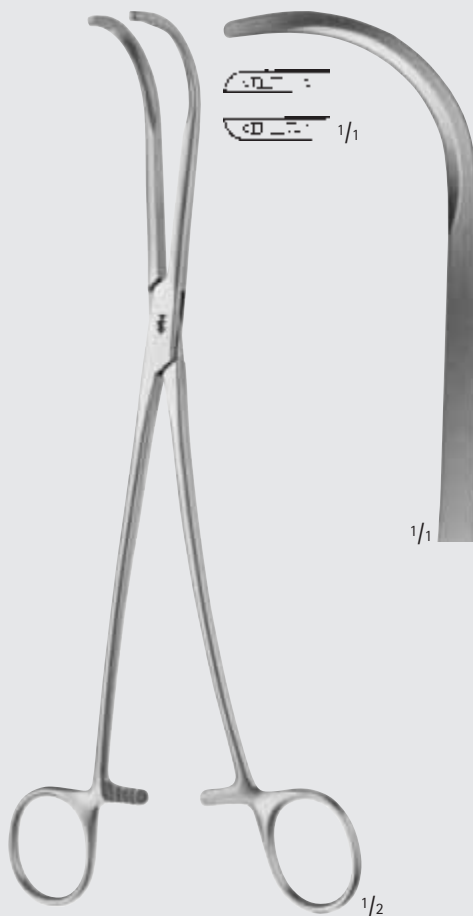

SEMB

FB961R

240 mm, 9 1/2"



WIKSTROEM

BJ051R

205 mm, 8"



Herz- und Gefäß-Chirurgie – Cardiovascular Surgery

Präparier- und Ligaturklemmen

Dissecting- and Ligature Forceps

FB



MIXTER

BJ055R

230 mm, 9"



MIXTER

BJ061R-BJ062R

BJ061R

220 mm

8 3/4"

BJ062R

250 mm

10"



MIXTER

BJ073R

290 mm, 11 1/2"



MILLIMETERS

Herz- und Gefäß-Chirurgie – Cardiovascular Surgery

Fixierklemme, Carotis Shunt Klemmen

Fixation Clamp, Carotid Shunt Clamps

FB



BORST

FB940R

Klemme für eine effiziente Verklebung von Gewebeschichten bei der Aortendissektion
Forceps for efficient tissue gluing in aortic dissection

215 mm, 8 1/2"



MB238R

168 mm

6 5/8"

MB239R

180 mm

7"

JAVID

MB238R-MB239R

Carotis Shunt Klemmen

Carotid shunt clamps



Herz- und Gefäß-Chirurgie – Cardiovascular Surgery

Gefäßklemmen
Vascular Clamps

FB



BABY-SATINSKY

FB600R

Anastomosen-Klemme

Anastomosis clamp

$1/2$ 150 mm, 6"



SATINSKY

FB602R

Anastomosen-Klemme

Anastomosis clamp

265 mm, 10 $1/2$ "

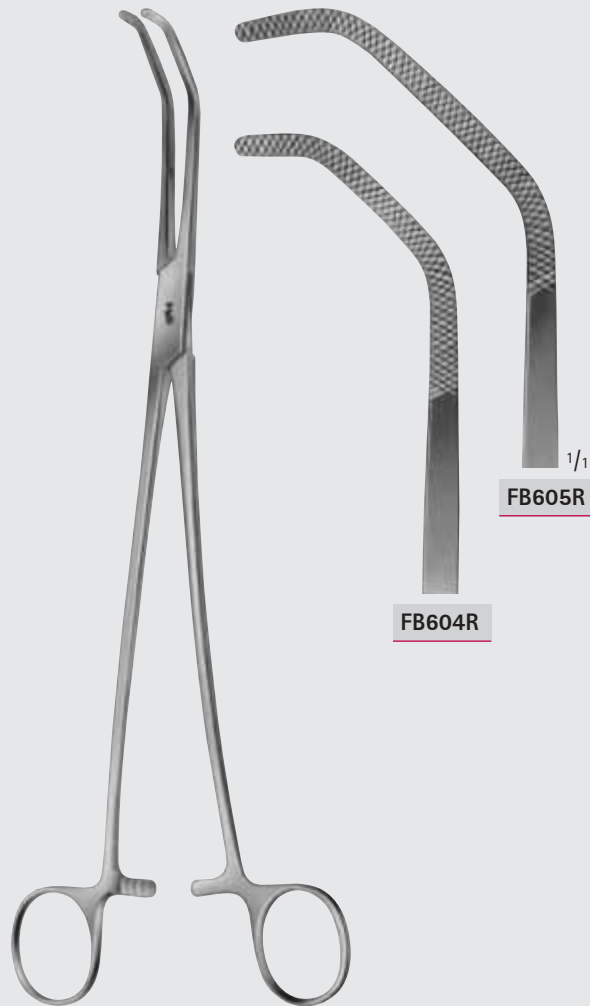

SATINSKY

FB604R-FB605R

Anastomosen-Klemmen

Anastomosis clamps

265 mm, 10 $1/2$ "

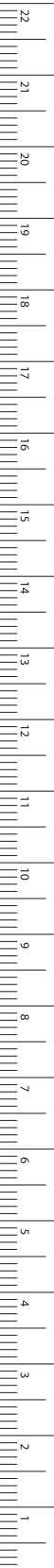

MILLIMETERS

Herz- und Gefäß-Chirurgie – Cardiovascular Surgery

Gefäßklemmen

Vascular Clamps

FB



FB633R

federnd
elastic

CRAFOORD-SELLORS

FB633R

240 mm, 9 1/2"



FB634R

federnd
elastic

FB635R

CRAFOORD

FB634R-FB635R

240 mm, 9 1/2"



Herz- und Gefäß-Chirurgie – Cardiovascular Surgery

Bronchusklemmen

Bronchus Forceps

FB



PRICE-THOMAS

FB950R

225 mm, 9"



FB955R

80 mm

FB954R

60 mm

FB954R-FB955R

230 mm, 9"



MILLIMETERS

Herz- und Gefäß-Chirurgie – Cardiovascular Surgery

Spülkanülen, Embolusfasszangen

Irrigating Cannulae, Embolus Grasping Forceps

FB



Ø 3 mm diam. 3 mm Ø 4 mm diam. 4 mm Ø 5 mm diam. 5 mm Ø 6 mm diam. 6 mm

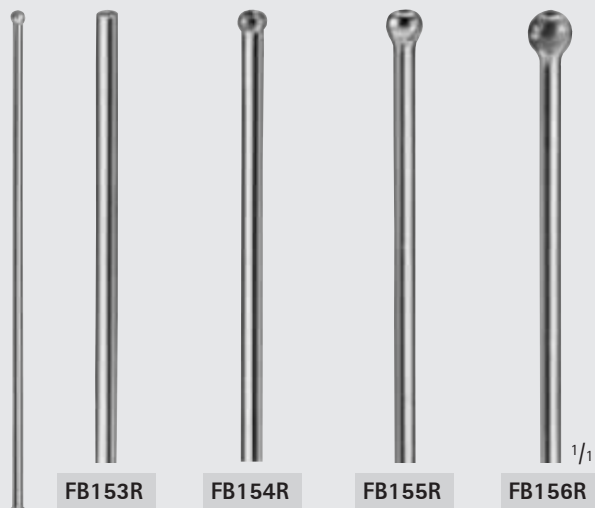

FB153R

FB154R

FB155R

FB156R

LUER LOCK 1/2

SCHMID

FB153R-FB156R

Gefäß-Spülkanülen,
biegsam, versilbert

Vessel irrigating cannulae,
malleable, silver plated

150 mm, 6"

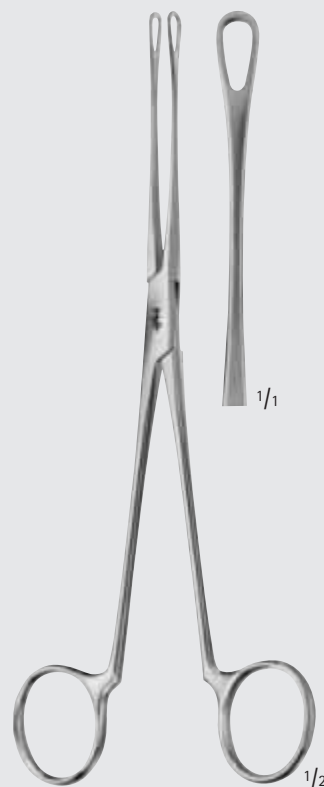

BLAKE

EB220R

Embolusfasszange

Embolus grasping forceps

205 mm, 8"



Herz- und Gefäß-Chirurgie – Cardiovascular Surgery
 Gefäßdilatoren
 Vascular dilators

FB

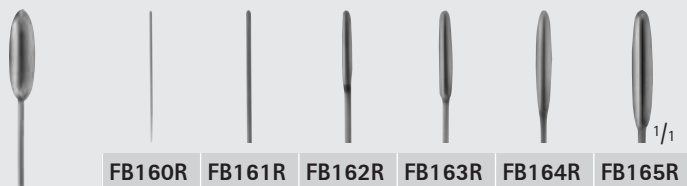
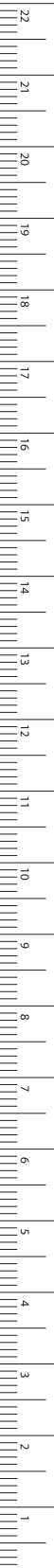

FB160R **FB161R** **FB162R** **FB163R** **FB164R** **FB165R**

	∅ Diam.
FB160R	0,5 mm
FB161R	1,0 mm
FB162R	1,5 mm
FB163R	2,0 mm
FB164R	2,5 mm
FB165R	3,0 mm

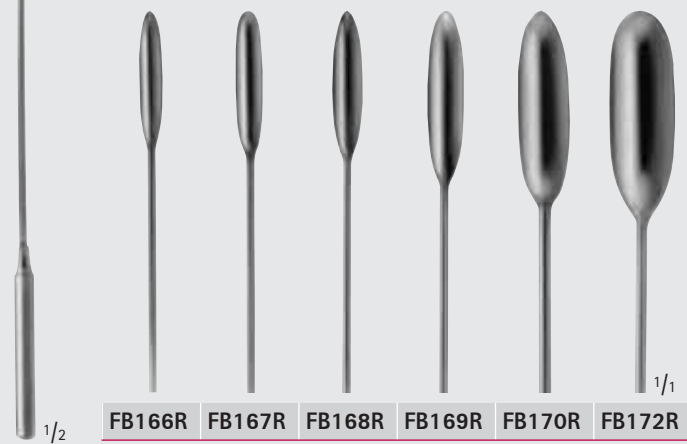

FB166R **FB167R** **FB168R** **FB169R** **FB170R** **FB172R**

	∅ Diam.
FB166R	3,5 mm
FB167R	4,0 mm
FB168R	4,5 mm
FB169R	5,0 mm
FB170R	7,0 mm
FB172R	9,0 mm

DE BAKEY

FB160R-FB172R

Gefäßdilatoren, biegsam
 Vascular dilators, malleable
 190 mm, 7 1/2"

Herz- und Gefäß-Chirurgie – Cardiovascular Surgery

Gefäßdilatoren

Vascular Dilators

FB

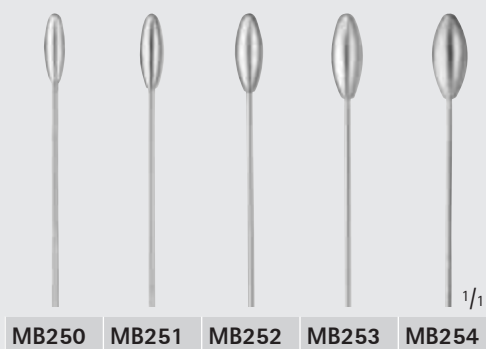
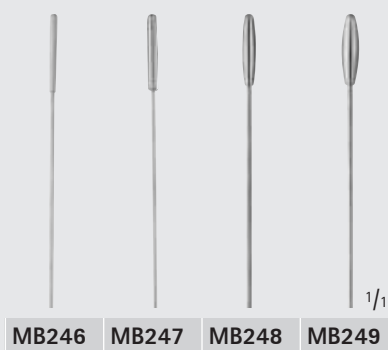

1/2

GARRETT

MB245

Set komplett,
bestehend aus:
MB246-MB254 jeweils 1 Dilator

Set complete,
consisting of:
MB246-MB254 1 dilator of each
140 mm, 5 1/2"

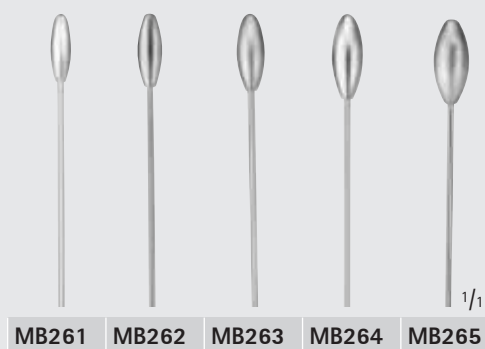

1/2

GARRETT

MB256

Set komplett,
bestehend aus:
MB257-MB265 jeweils 1 Dilator

Set complete,
consisting of:
MB257-MB265 1 dilator of each
215 mm, 8 1/2"



Herz- und Gefäß-Chirurgie – Cardiovascular Surgery

Gefäßspatel Vascular Spatulas

FB



FB150R	185 mm	7 1/4"
FB151R	215 mm	8 1/2"



FD333R	230 mm, 9"
---------------	------------

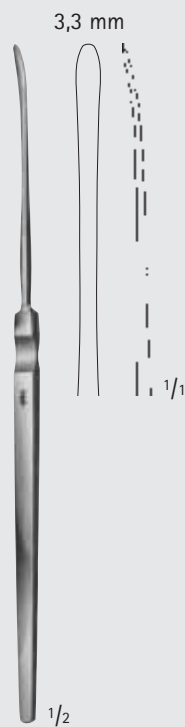

HALLE	OL160R
stumpf blunt	180 mm, 7"



FREER	OL165R
scharf/stumpf sharp/blunt	185 mm, 7 1/4"

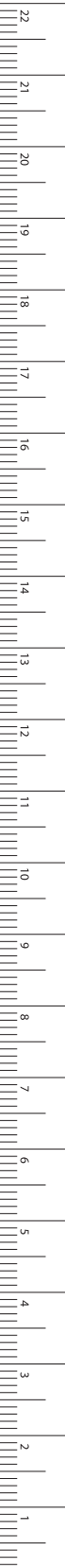

MILLIMETERS

Herz- und Gefäß-Chirurgie – Cardiovascular Surgery

Gefäßspatel

Vascular Spatulas

FB

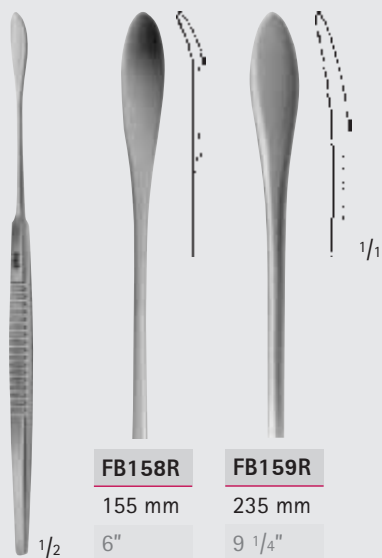

FB158R

155 mm

6"

FB159R

235 mm

9 1/4"

SCHMID

FB158R-FB159R

stumpf

blunt



DAVIS

FF300R

245 mm, 9 3/4"

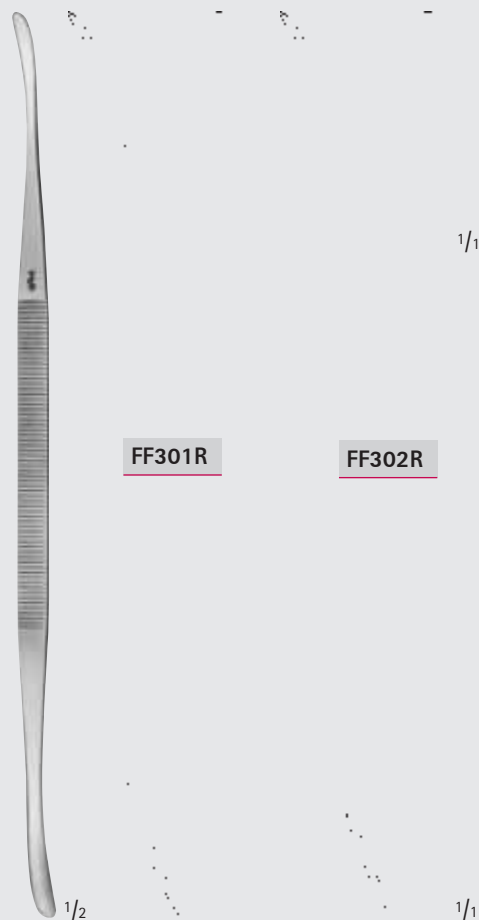

FF301R

FF302R

TÖNNIS

FF301R-FF302R

240 mm, 9 1/2"



Herz- und Gefäß-Chirurgie – Cardiovascular Surgery

Endarterektomiestripper, Tourniquets

Endarterectomy Strippers, Tourniquets

FB

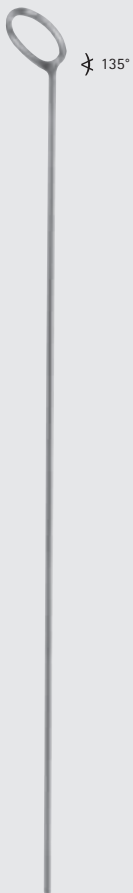
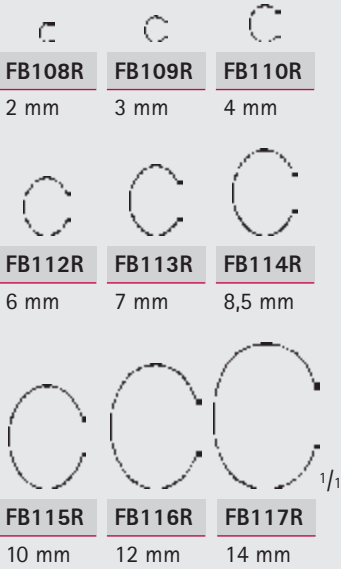

FB108R-FB117R
Endarterektomiestripper
Endarterectomy strippers
550 mm, 22"



FB119R
Griff für FB108R-FB117R
Handle for FB108R-FB117R
110 mm, 4 3/8"



RUMEL-BELMONT
FB651R
Ø
diam.
4 mm
325 mm, 13"



FB653R
Mandrin allein
Guide only



FB654R
Mandrin allein
Guide only

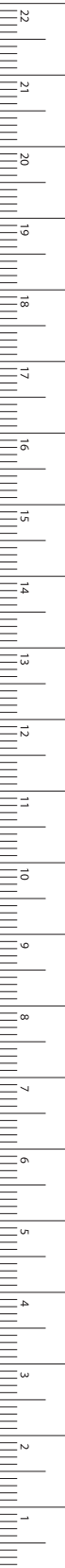

Herz- und Gefäß-Chirurgie – Cardiovascular Surgery

Bioptom und Aorta-Dilatatoren, Aortenstanzen

Bioptome und Aortic Dilators, Aorta Punches

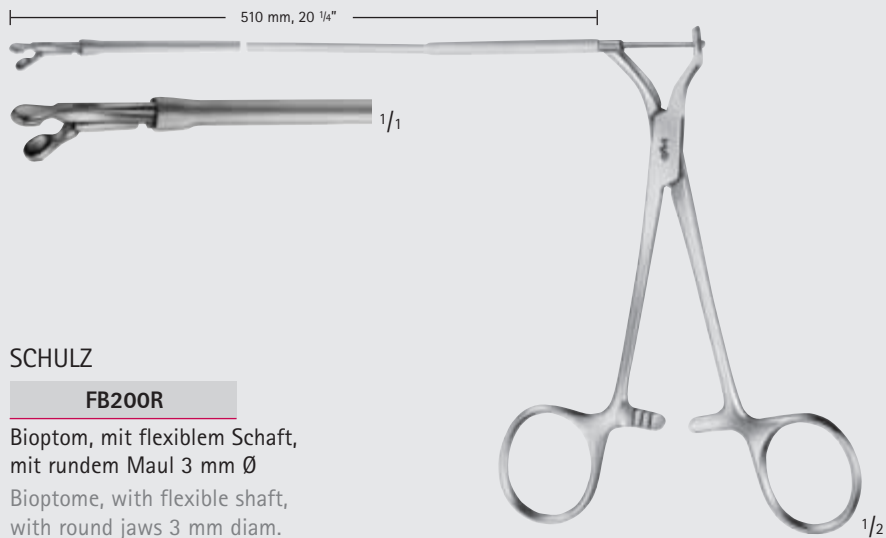

SCHULZ

FB200R

Bioptom, mit flexiblem Schaft,
mit rundem Maul 3 mm Ø

Bioptome, with flexible shaft,
with round jaws 3 mm diam.

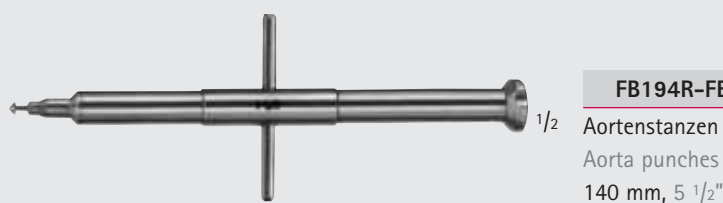

FB194R-FB196R

Aortenstanzen
Aorta punches
140 mm, 5 1/2"

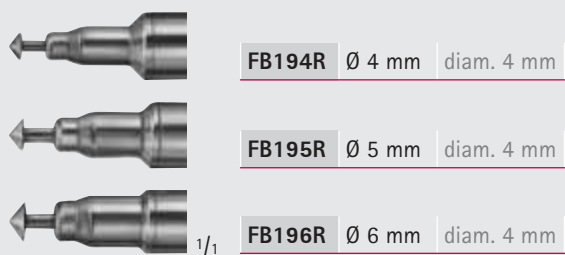

FB194R Ø 4 mm diam. 4 mm

FB195R Ø 5 mm diam. 4 mm

FB196R Ø 6 mm diam. 4 mm

VASCUCUT Stanzenköpfe
Bestelleinheit:

PAK = Packung à 5 Stück

VASCUCUT Punch heads

Sales unit:

PAK = Package of 5 pieces



FB184R

Ø 4 mm
diam. 4 mm

FB185R

Ø 5 mm
diam. 5 mm

FB186R

Ø 6 mm
diam. 6 mm

FB180R

VASCUCUT Handgriff allein
VASCUCUT Handle only

FB



Herz- und Gefäß-Chirurgie – Cardiovascular Surgery

Tunnelierungs- und Durchzugsinstrumentarium für Gefäßprothesen Instrument Set for Tunnelling and Pulling-Through Vascular Grafts

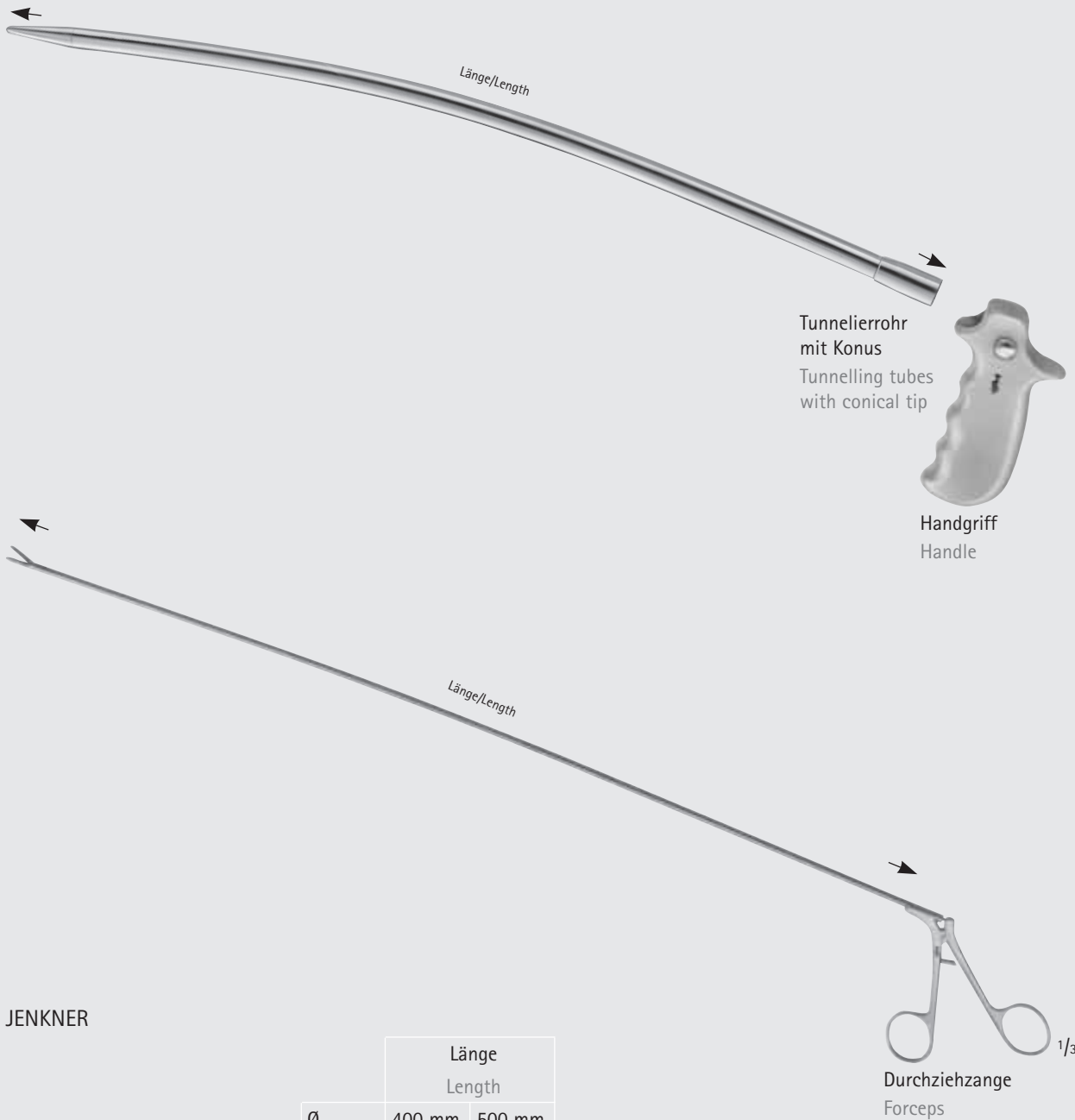
JENKNER

	Ø Diam.	Länge Length	
		400 mm 20"	500 mm 20"
Tunnelierrohre mit Konus Tunnelling tubes with conical tip	12 mm	FC004R	FC005R
	14 mm	FC014R	FC015R
	17 mm		FC025R
Handgriff Handle		FC030	
Durchziehzange Forceps		FC034R	FC035R

Informationen über das operative Vorgehen siehe Prospekt C-060.
Information about the operative procedure see leaflet C-060.

Herz- und Gefäß-Chirurgie – Cardiovascular Surgery

Gefäßprothesen-Durchziehzange

Vascular Prosthesis Draw-In Forceps

Die leichte Krümmung der Zange ermöglicht ein Handling beim Tunnelieren. Zum Durchziehen der Prothese kann die Zange entweder direkt angelegt werden (alloplastische Prothesen) oder mittels der Bulldogklemme (autologe/homologe Prothesen). Die Bulldogklemme sitzt dank Formschluss unverrückbar und sicher im Maul der Einzugszange.

The slight curvature of the introducer forceps permits handling during tunneling. Here the prosthesis can be drawn in by applying the introducer forceps directly to the prosthesis (alloplastic prosthesis) or can be drawn in by means of the bulldog clamp (autologous/homologous prosthesis). Thanks to the interlocking fit, the bulldog clamp rests non-displaceable and securely in the mouth of the introducer forceps.



ALLENBERG

FC048R

gebogen
curved

540 mm, 21 1/2"



FC049R

Bulldog-Klemme
Bulldog clamp
40 mm, 1 1/2"



WITT

SR421R

1,5 x 51 mm

Sternum-Punktionskanüle
mit Luer-Ansatz

Sternal puncture needle
with Luer cone



SCHUMACHER

FB911R

Sternumschere
Sternal shears
210 mm, 8 1/4"

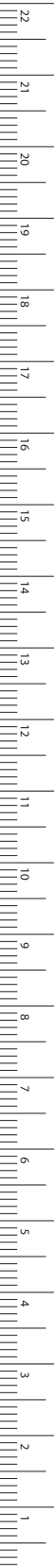

MILLIMETERS

Herz- und Gefäß-Chirurgie – Cardiovascular Surgery

Sternum-Instrumente

Sternum Instruments

FB



BRAUN-STADLER

ET141R

Sternumschere für Kinder
Sternum shears for children
200 mm, 8"



LEBSCHE

FB918R

Sternummeißel
Sternum chisel
200 mm, 8"



Herz- und Gefäß-Chirurgie – Cardiovascular Surgery

Rippenscheren Rib Shears

FB



FB870R

230 mm, 9"



GLUCK

FB873

190 mm, 7 1/2"



BETHUNE

FB878R

340 mm, 13 1/2"



SAUERBRUCH

FB881R

für Kinder
for children

240 mm, 9 1/2"

FB882R

für Erwachsene
for adults

270 mm, 10 3/4"

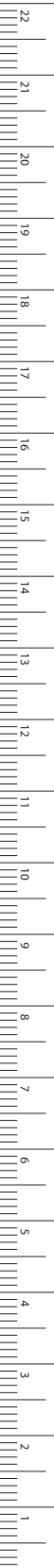

MILLIMETERS

Herz- und Gefäß-Chirurgie – Cardiovascular Surgery

Rippenscheren

Rib Shears

FB



BRUNNER

FB892R

Universalmodell

Universal pattern

340 mm, 13 1/2"



GIERTZ-STILLE

FB890R

250 mm, 10"



Herz- und Gefäß-Chirurgie – Cardiovascular Surgery

Rippenfasszangen, Knochensplitterzangen
Rib Holding Forceps, Bone Cutting Forceps

FB

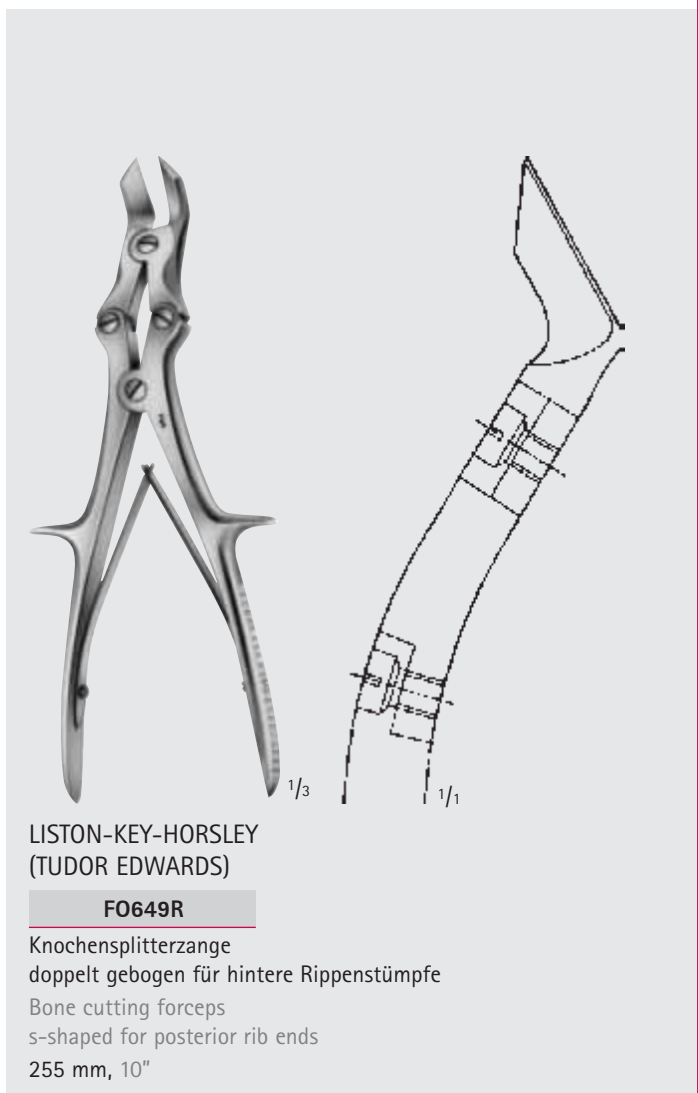
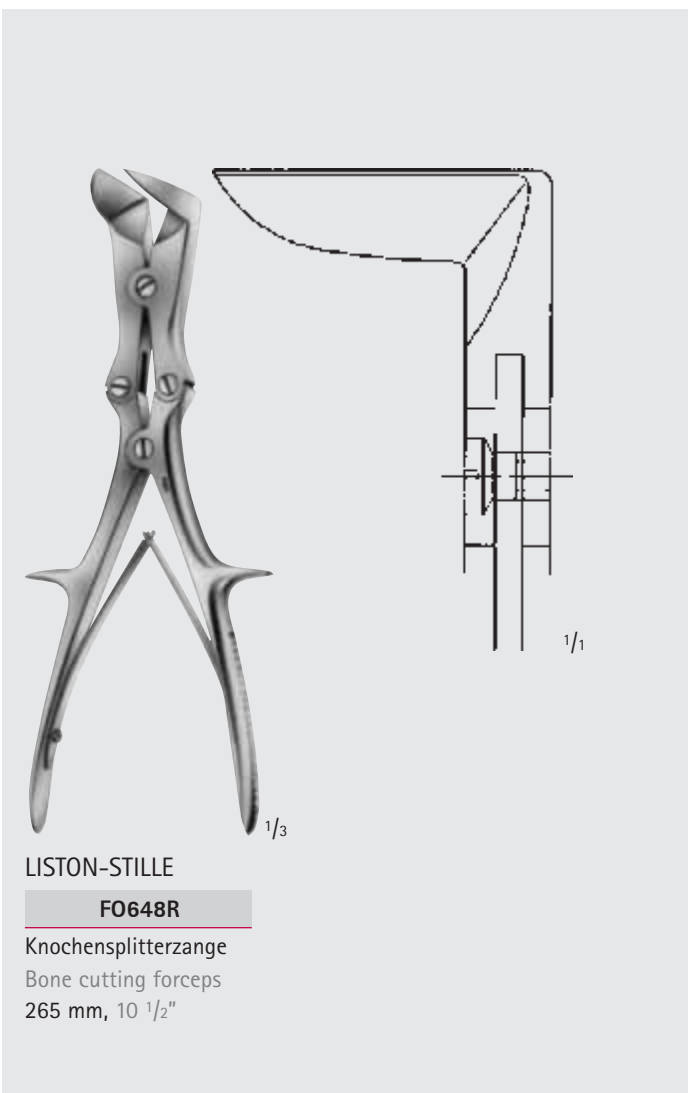
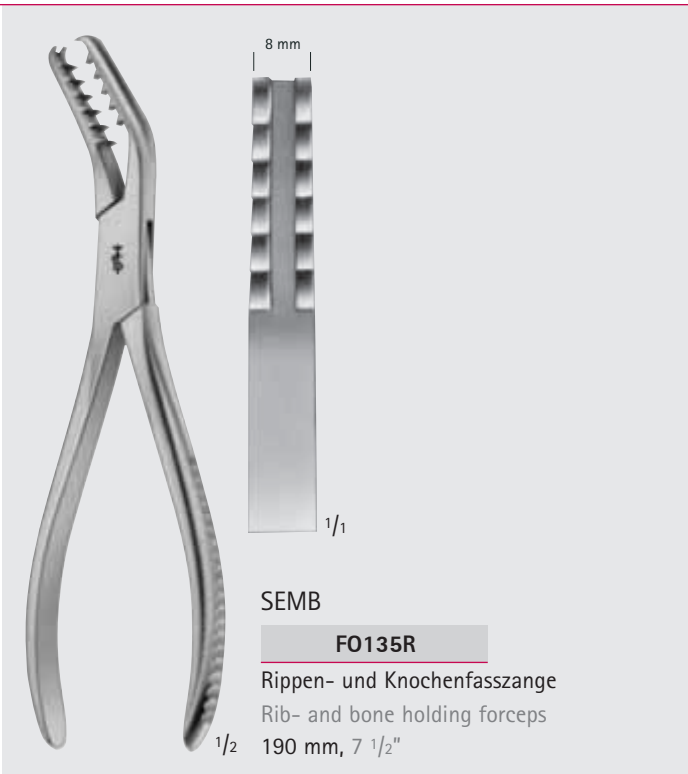

MILLIMETERS

Herz- und Gefäß-Chirurgie – Cardiovascular Surgery

Hohlmeißelzangen

Rib Rongeurs

Weitere Knochenhaltezangen, Knochensplitzerzangen und Hohlmeißelzangen siehe Rubrik FO
Further bone holding forceps, bone cutting forceps and bone rongeurs see section FO

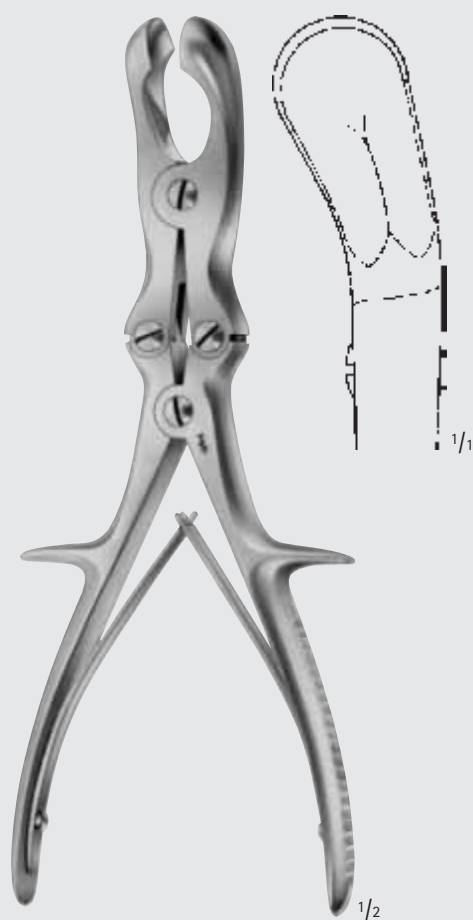

SEMBO

FO555R

Hohlmeißelzange zum Kürzen der Rippenstümpfe
Rib rongeur to shorten the rib stumps

240 mm, 9 1/2"

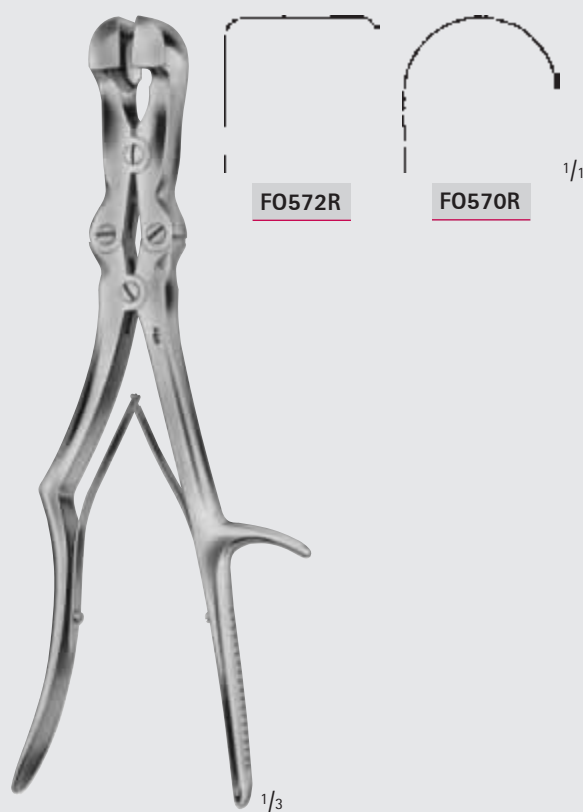

SAUERBRUCH-CORYLLOS

FO570R-FO572R

Hohlmeißelzange zum Kürzen der Rippenstümpfe
Rib rongeur to shorten the rib stumps

310 mm, 12 3/8"





Herz- und Gefäß-Chirurgie – Cardiovascular Surgery

Rippenraspatorien

Rib Raspatories

FB



DOYEN

FK400R-FK401R

für Kinder
for children
175 mm, 7"

1/2



DOYEN

FK402R-FK403R

für Erwachsene
for adults
175 mm, 7"

1/2

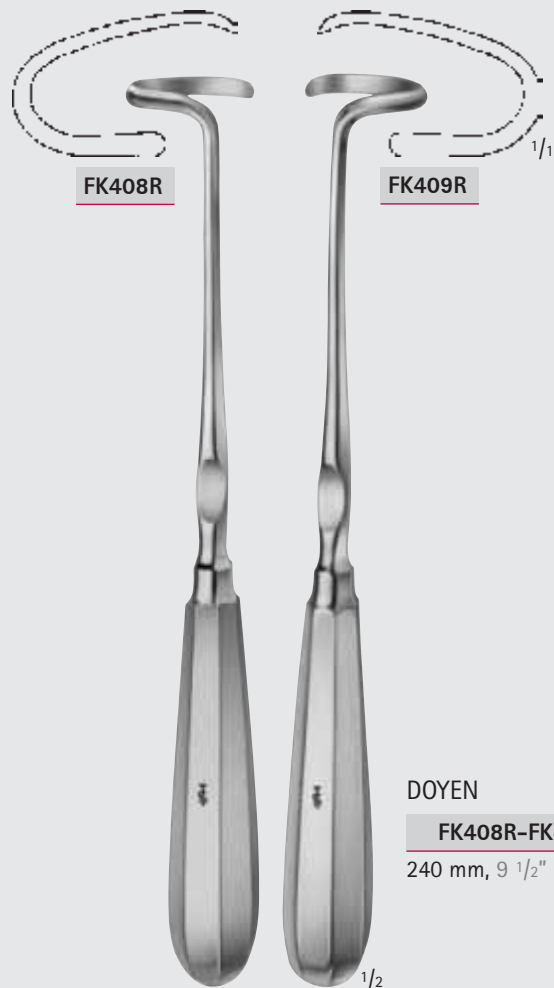

DOYEN

FK408R-FK409R

240 mm, 9 1/2"

1/2



MILLIMETERS

Herz- und Gefäß-Chirurgie – Cardiovascular Surgery

Rippenraspatorien

Rib Raspatories

FB

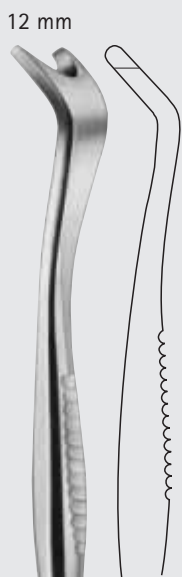

FK381R
190 mm
7 1/2"

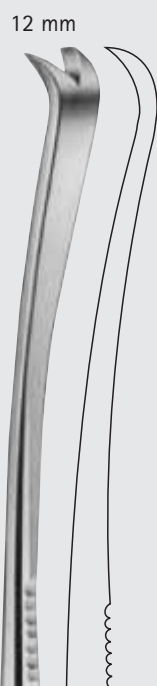

FK382R
230 mm
9"



FK383R
230 mm
9"



FK384R
230 mm
9"



FK387R
230 mm
9"

SEMB

FK381R-FK387R



Herz- und Gefäß-Chirurgie – Cardiovascular Surgery

Rippenraspatorien

Rib Raspatories

FB

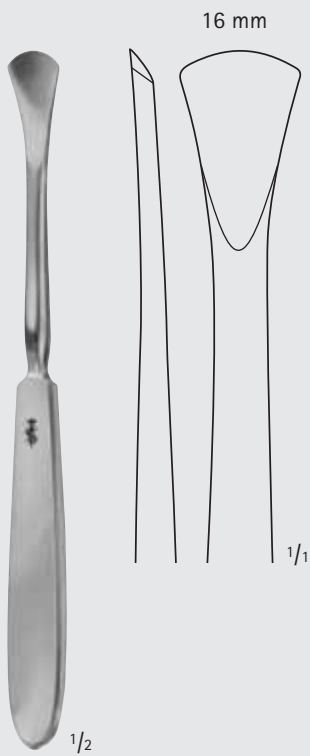

LANGENBECK

FK360R

190 mm, 7 1/2"



LAMBOTTE

FK355R 5 mm

FK356R 10 mm

FK357R 15 mm

FK358R 20 mm

FK359R 25 mm

215 mm, 8 1/2"

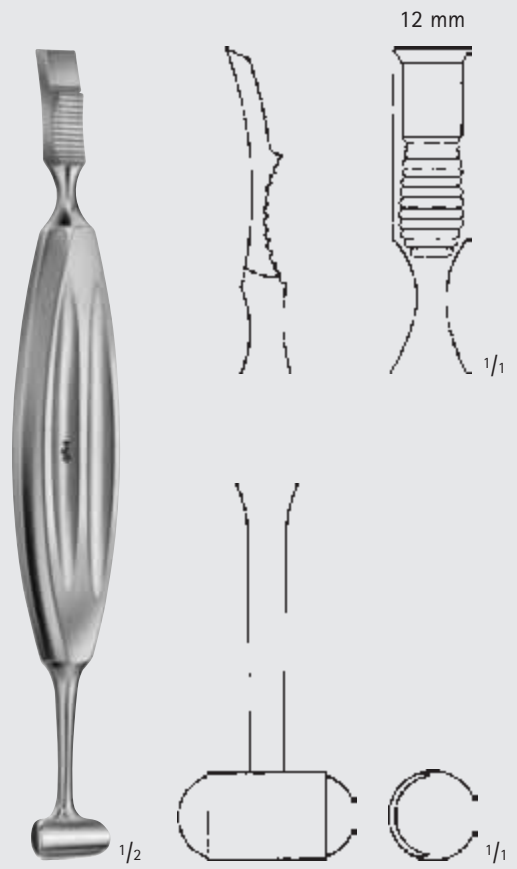

ALEXANDER

FK420R

210 mm, 8 1/4"

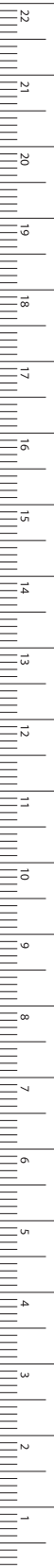

MILLIMETERS

Herz- und Gefäß-Chirurgie – Cardiovascular Surgery

Thoraxsperrer (Aluminium)

Thoracic Retractors (Aluminium)

FB



Maßangaben für Blattgrößen der Rippensperrer

1. Zahl = Tiefe Beispiel: 38 x 45 mm

2. Zahl = Breite

Dimensions for blade size of rib spreaders:

1st number = depth Example: 38 x 45 mm

2nd number = width

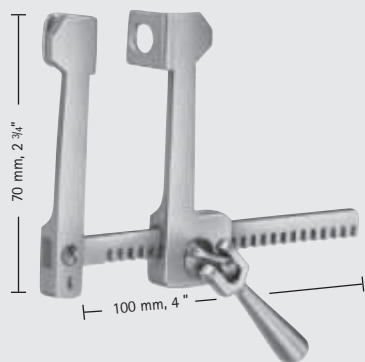

Blätter
Blades
FINOCHIETTO
FC040A 12 x 15 mm

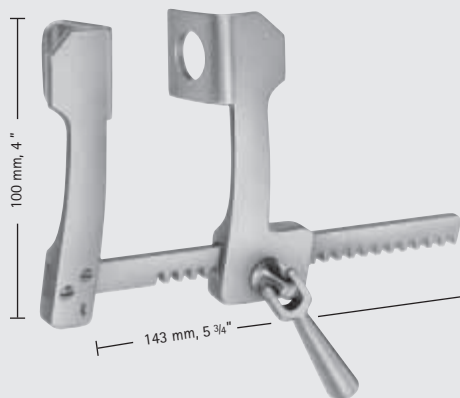

Blätter
Blades
FINOCHIETTO
FC041A 28 x 30 mm

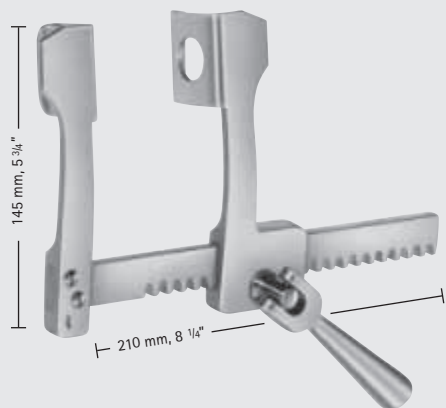

Blätter
Blades
FINOCHIETTO
FC042A 31 x 45 mm

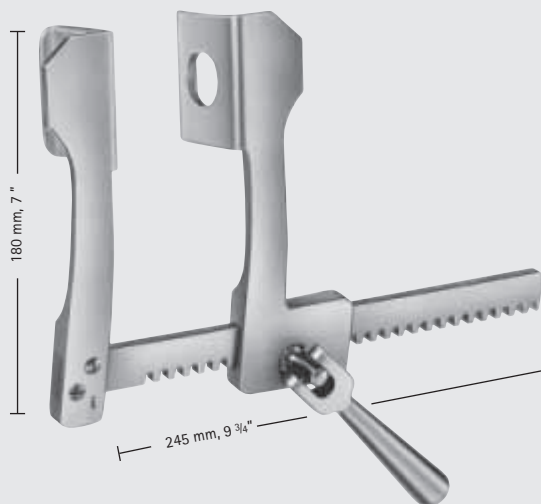

Blätter
Blades
FINOCHIETTO
FC043A 42 x 61 mm





Herz- und Gefäß-Chirurgie – Cardiovascular Surgery

Thoraxsperrer (Aluminium), Rippensperrer für Kleinkinder
Thoracic Retractors (Aluminium), Rib Retractors for Infants

FB

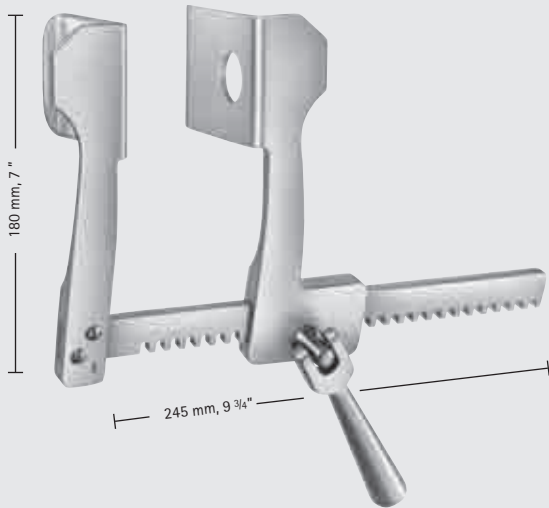

FINOCHIETTO
Blätter
Blades
FC044A 74 x 64 mm

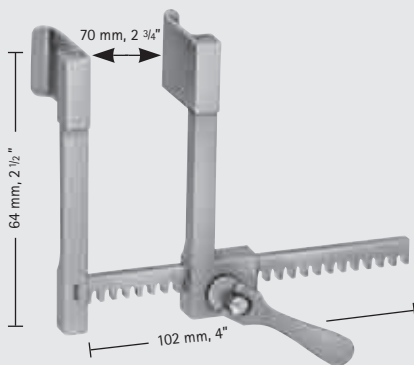

STRUCK
FB852R

Rippensperrer für Kleinkinder
komplett,
bestehend aus:

- FB853R Sperrer allein
- FB857R Blätter (Paar)
- FB858R Blätter (Paar)

Rib spreader for infants complete,
consisting of:

- FB853R Retractor only
- FB857R Blades (pair)
- FB858R Blades (pair)

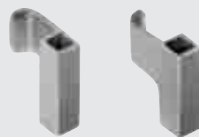

Blätter
Blades

FB854R 10 x 10 mm

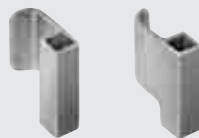

Blätter
Blades

FB855R 10 x 15 mm



Blätter
Blades

FB857R 15 x 20 mm



Blätter
Blades

FB856R 10 x 20 mm



Blätter
Blades

FB858R 20 x 20 mm

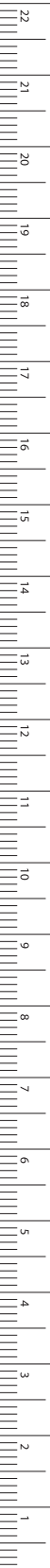

MILLIMETERS

Herz- und Gefäß-Chirurgie – Cardiovascular Surgery

Rippensperrer für Kinder
Rib Retractors for Infants

FB

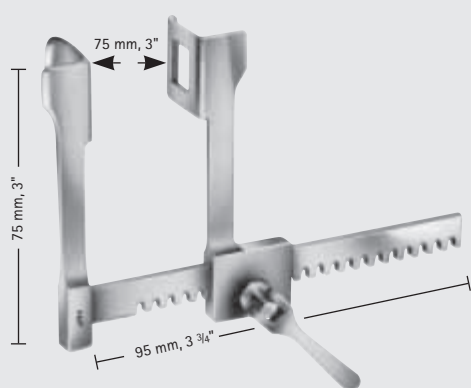

FINOCHIETTO
Blätter
Blades
FB830R 18 x 21 mm

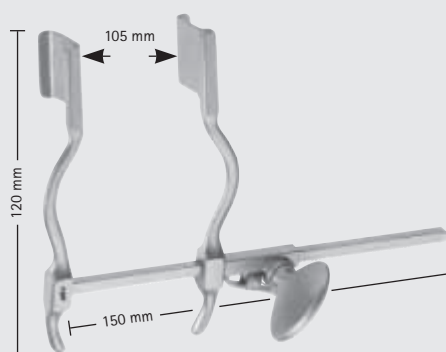

HERTZLER
Blätter
Blades
BV512R 20 x 25 mm

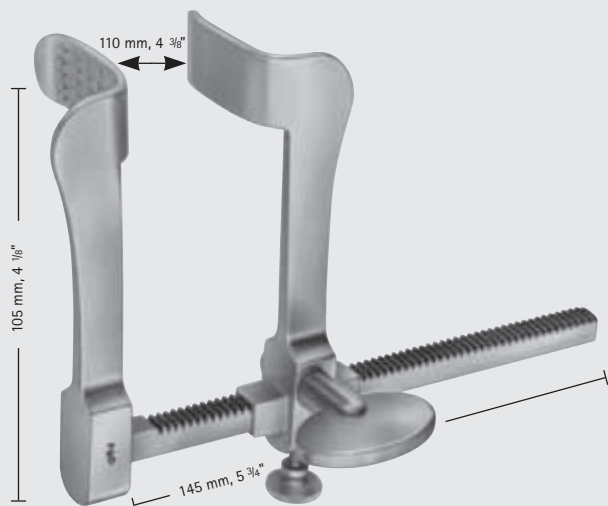

TUFFIER
Blätter
Blades
FB847R 32 x 19 mm





Herz- und Gefäß-Chirurgie – Cardiovascular Surgery

Rippensperrer Rib Retractors

FB

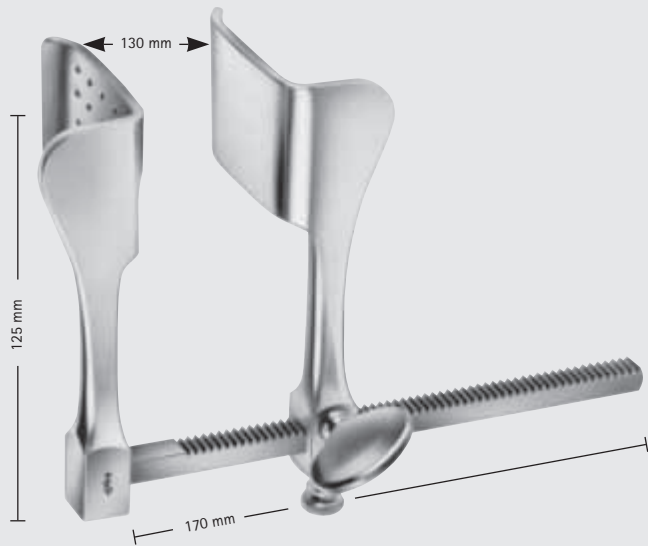

TUFFIER

Blätter
Blades

FB800R

43 x 53 mm

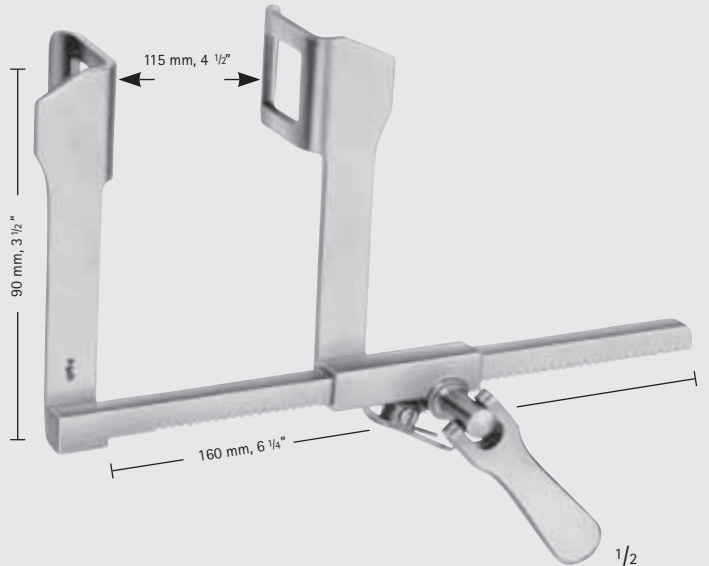

HAIGHT

Blätter
Blades

FB835R

30 x 30 mm

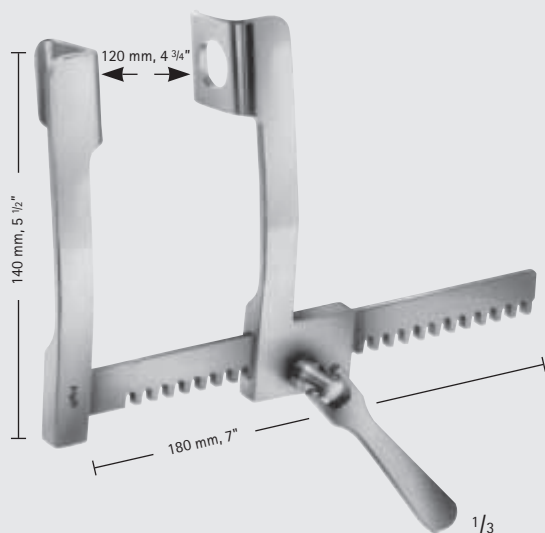

FINOCHIETTO

Blätter
Blades

FB836R

28 x 32 mm

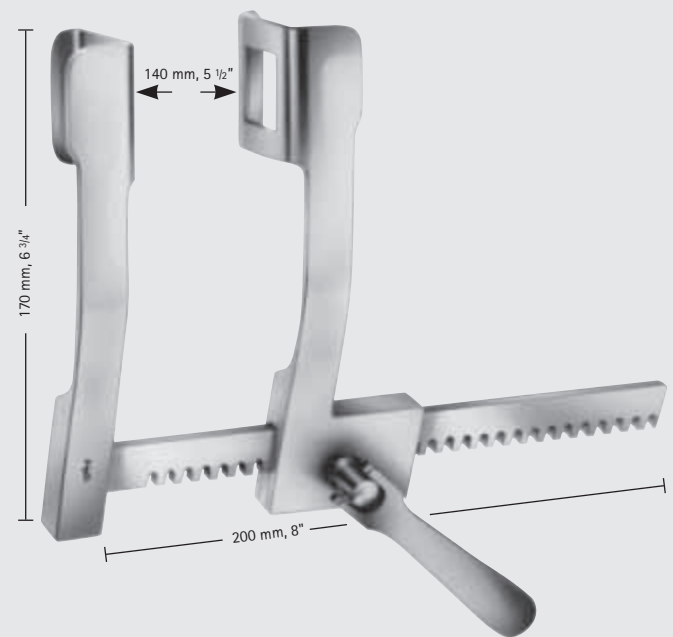

FINOCHIETTO

Blätter
Blades

FB802R

36 x 45 mm



MILLIMETERS

Herz- und Gefäß-Chirurgie – Cardiovascular Surgery

Rippensperrer

Rib Retractors

FB

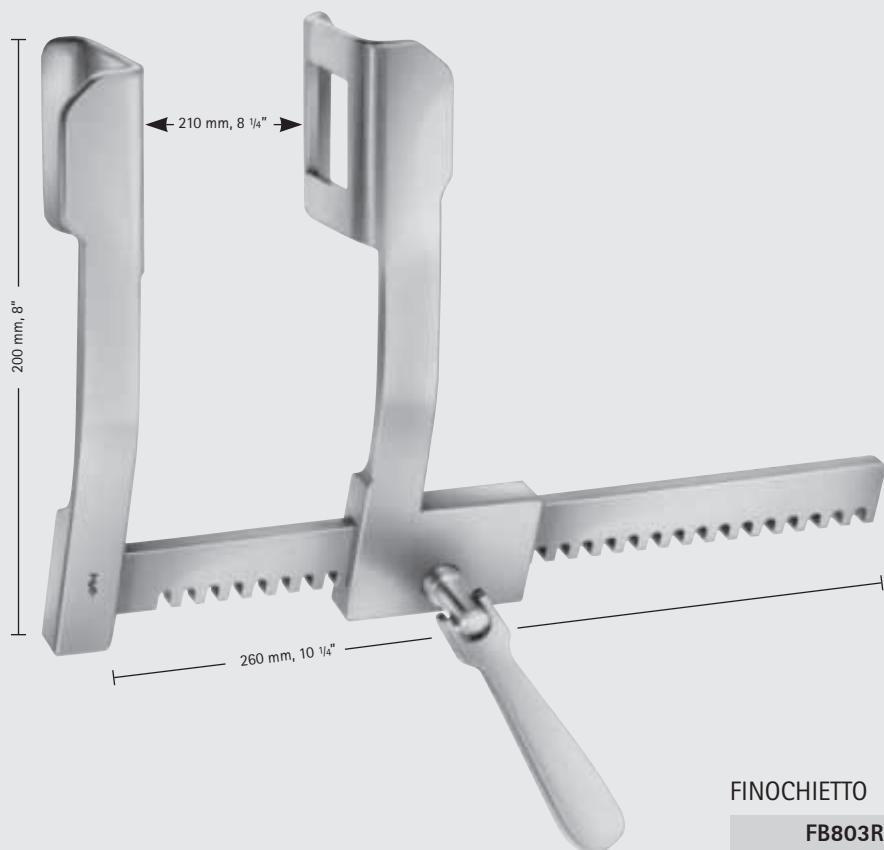

FINOCHIETTO

FB803R

Blätter

Blades

44 x 65 mm

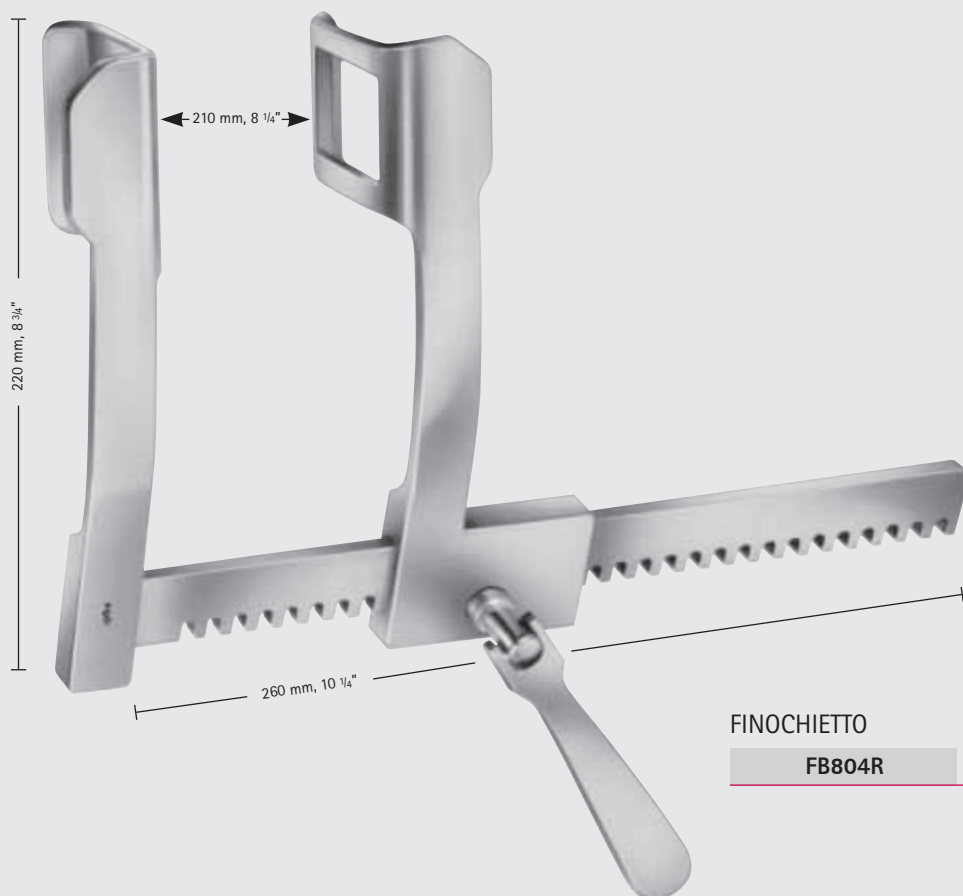

FINOCHIETTO

FB804R

Blätter

Blades

65 x 65 mm





Herz- und Gefäß-Chirurgie – Cardiovascular Surgery

Rippensperrer
Rib Retractors

FB

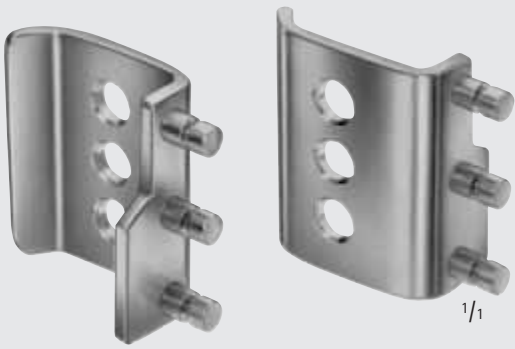

Blätter
Blades

FB806R 45 x 64 mm

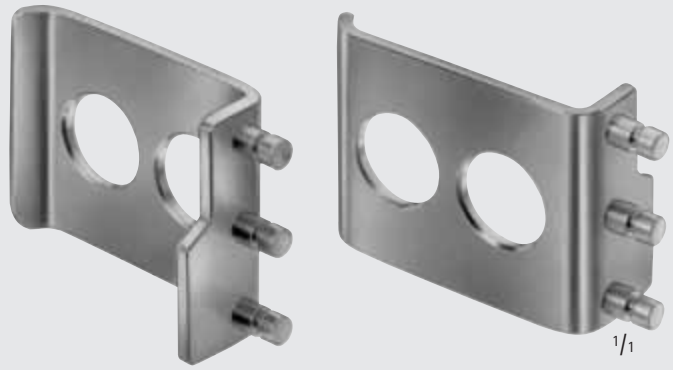

Blätter
Blades

FB807R 75 x 64 mm

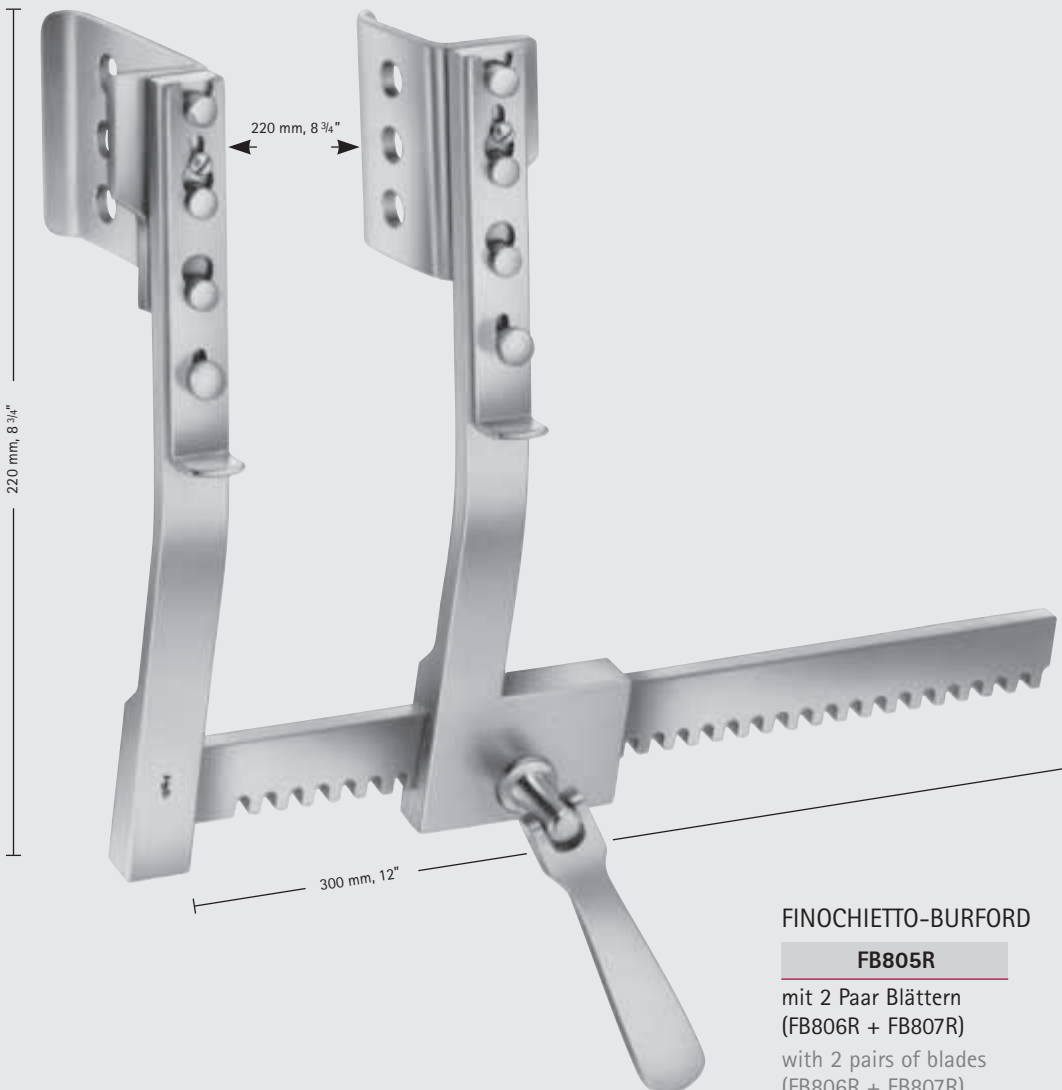

FINOCHIETTO-BURFORD

FB805R

mit 2 Paar Blättern
(FB806R + FB807R)

with 2 pairs of blades
(FB806R + FB807R)



MILLIMETERS

Herz- und Gefäß-Chirurgie – Cardiovascular Surgery

Rippensperrer

Rib Retractors

Besondere Vorteile:

- Blätter ohne Schrauben und Hebel austauschbar.
- Keine überstehenden Teile, glatte Flächen, daher kein Hängenbleiben von Ligaturfäden usw.

Special advantages:

- Improved fixing system for interchangeable blades.
- No protruding parts, therefore no risk of catching sutures.

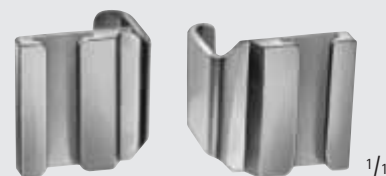

FB810R 30 x 30 mm

Blätter

Blades



FB811R 40 x 40 mm

Blätter

Blades



FB812R 50 x 50 mm

Blätter

Blades

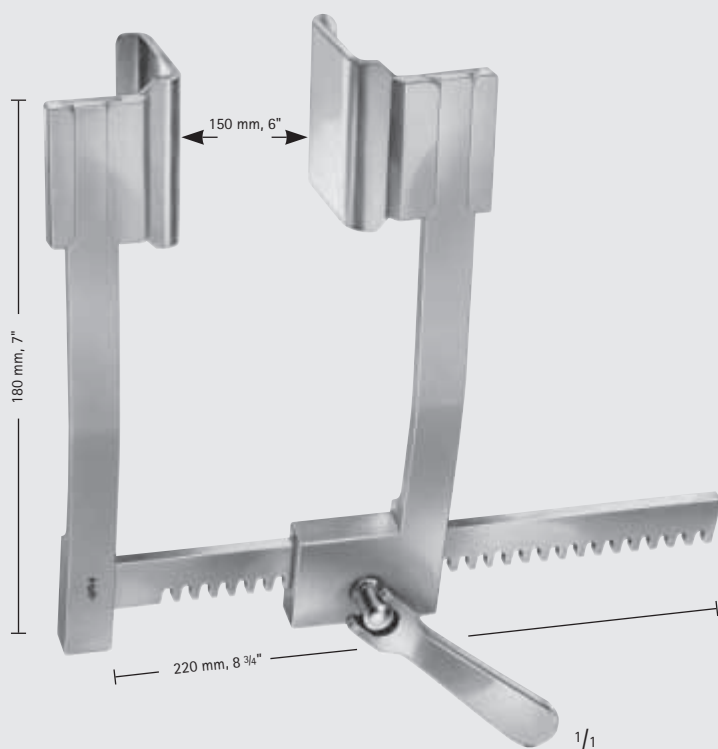

DE BAKEY

FB808R

Rippensperrer komplett,
bestehend aus:

- FB809R Sperrer allein
- FB810R Blätter (Paar)
- FB811R Blätter (Paar)
- FB812R Blätter (Paar)

Rib spreader complete,
consisting of:

- FB809R Spreader only
- FB810R Blades (pair)
- FB811R Blades (pair)
- FB812R Blades (pair)

Herz- und Gefäß-Chirurgie – Cardiovascular Surgery

Rippensperrer Rib Retractors

Besondere Vorteile:

- Blätter ohne Schrauben und Hebel austauschbar.
- Keine überstehenden Teile, glatte Flächen, daher kein Hängenbleiben von Ligaturfäden usw.

Special advantages:

- Improved fixing system for interchangeable blades.
- No protruding parts, therefore no risk of catching sutures.

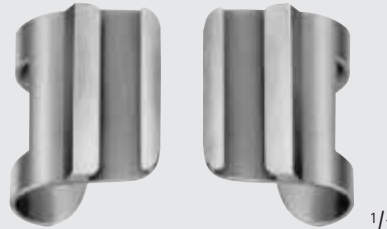

FB813R 50 x 66 mm
Sternotomieblätter
Sternotomy blades



FB816R 60 x 60 mm
Blätter
Blades



FB817R 50 x 80 mm
Blätter
Blades



FB818R 40 x 100 mm
Blätter
Blades

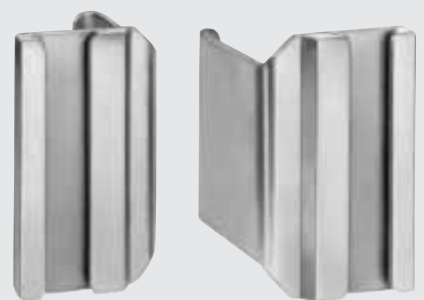

FB819R 80 x 60 mm
Blätter
Blades

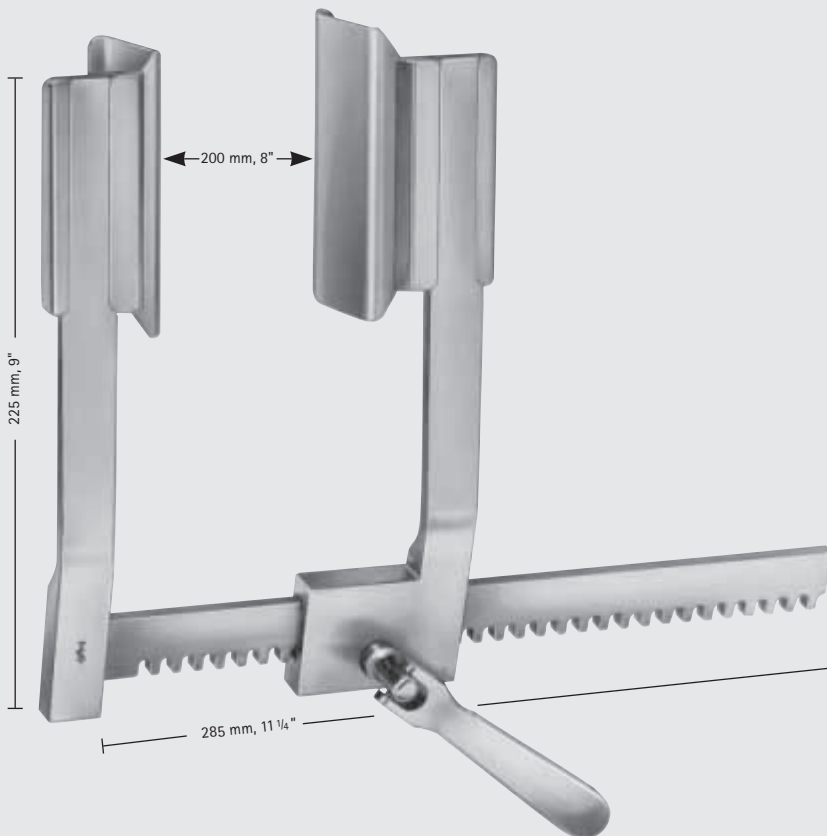

DE BAKEY

FB814R

Rippensperrer komplett,
bestehend aus:

- FB815R Sperrer allein
- FB816R Blätter (Paar)
- FB817R Blätter (Paar)
- FB818R Blätter (Paar)

Spreader complete,
consisting:

- FB815R Spreader only
- FB816R Blades (pair)
- FB817R Blades (pair)
- FB818R Blades (pair)

Herz- und Gefäß-Chirurgie – Cardiovascular Surgery

Sternum-Sperrer
Sternum Spreaders

FB

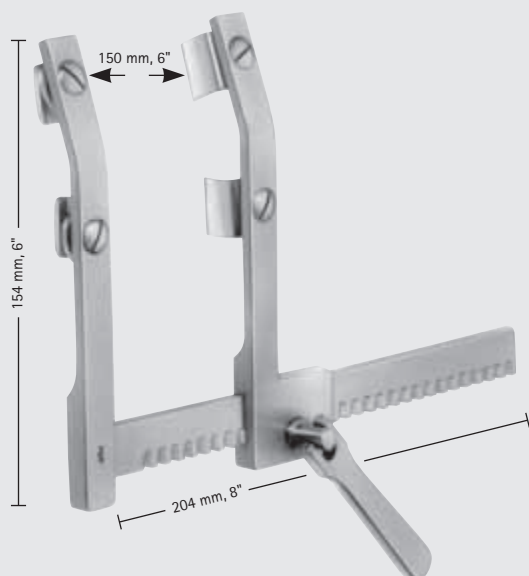

MORSE

FB845R

für Kinder
mit beweglichen Doppelblättern
Blätter jeweils 12 x 20 mm
for children
with movable double blades
each blade 12 x 20 mm

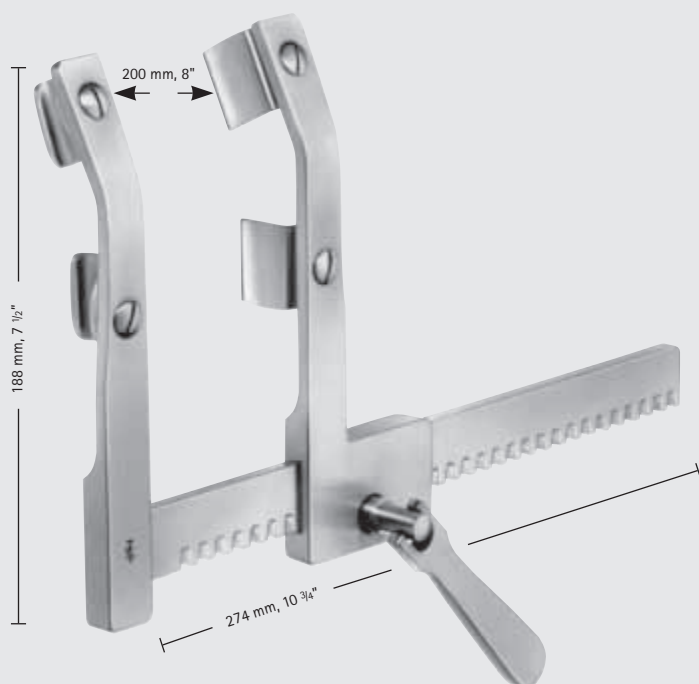

MORSE

FB846R

für Erwachsene
mit beweglichen
Doppelblättern
Blätter jeweils 19 x 29 mm
for adults
with movable double blades
each blade 19 x 29 mm



Herz- und Gefäß-Chirurgie – Cardiovascular Surgery

Sternum-Sperrer
Sternum Spreaders

FB

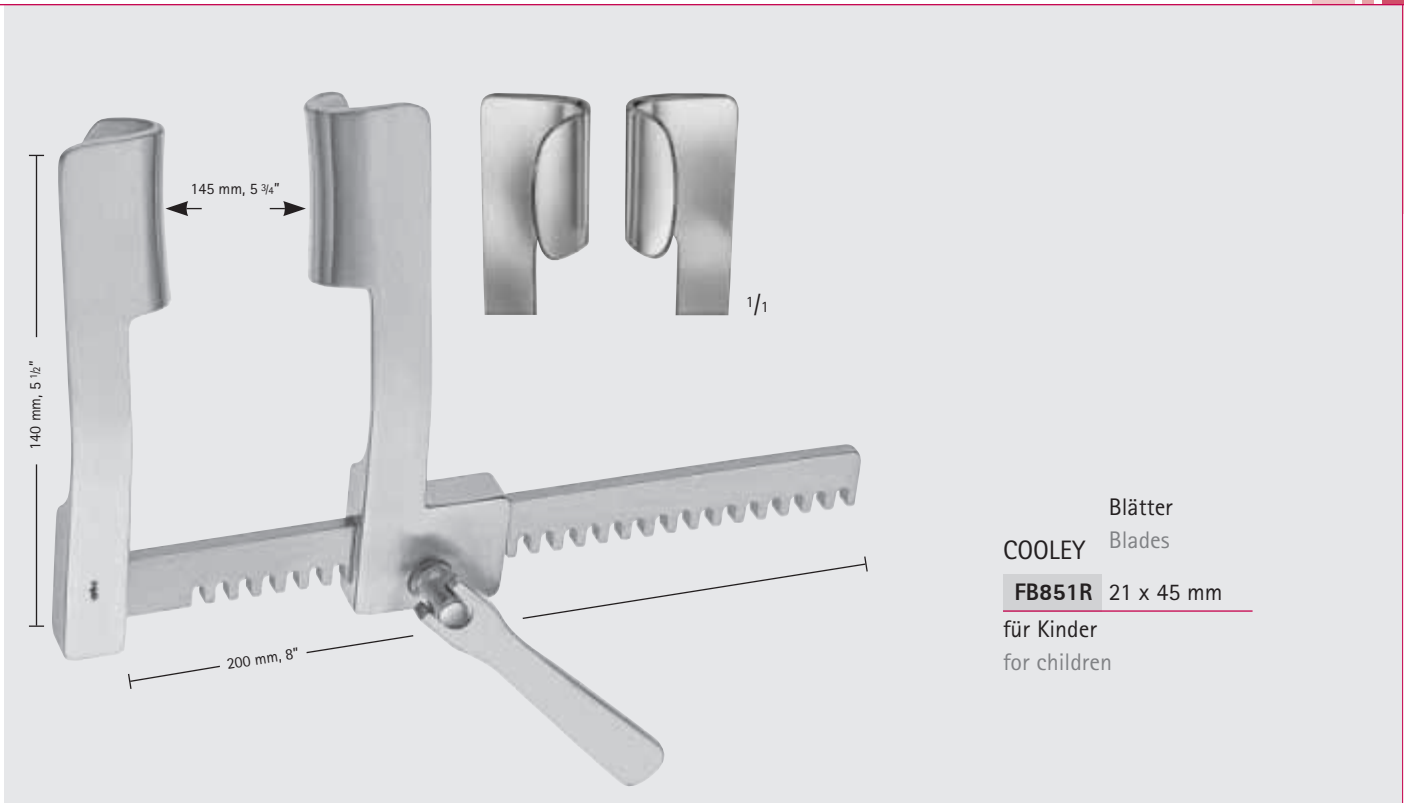

Blätter
Blades

COOLEY **FB851R** 21 x 45 mm

für Kinder
for children

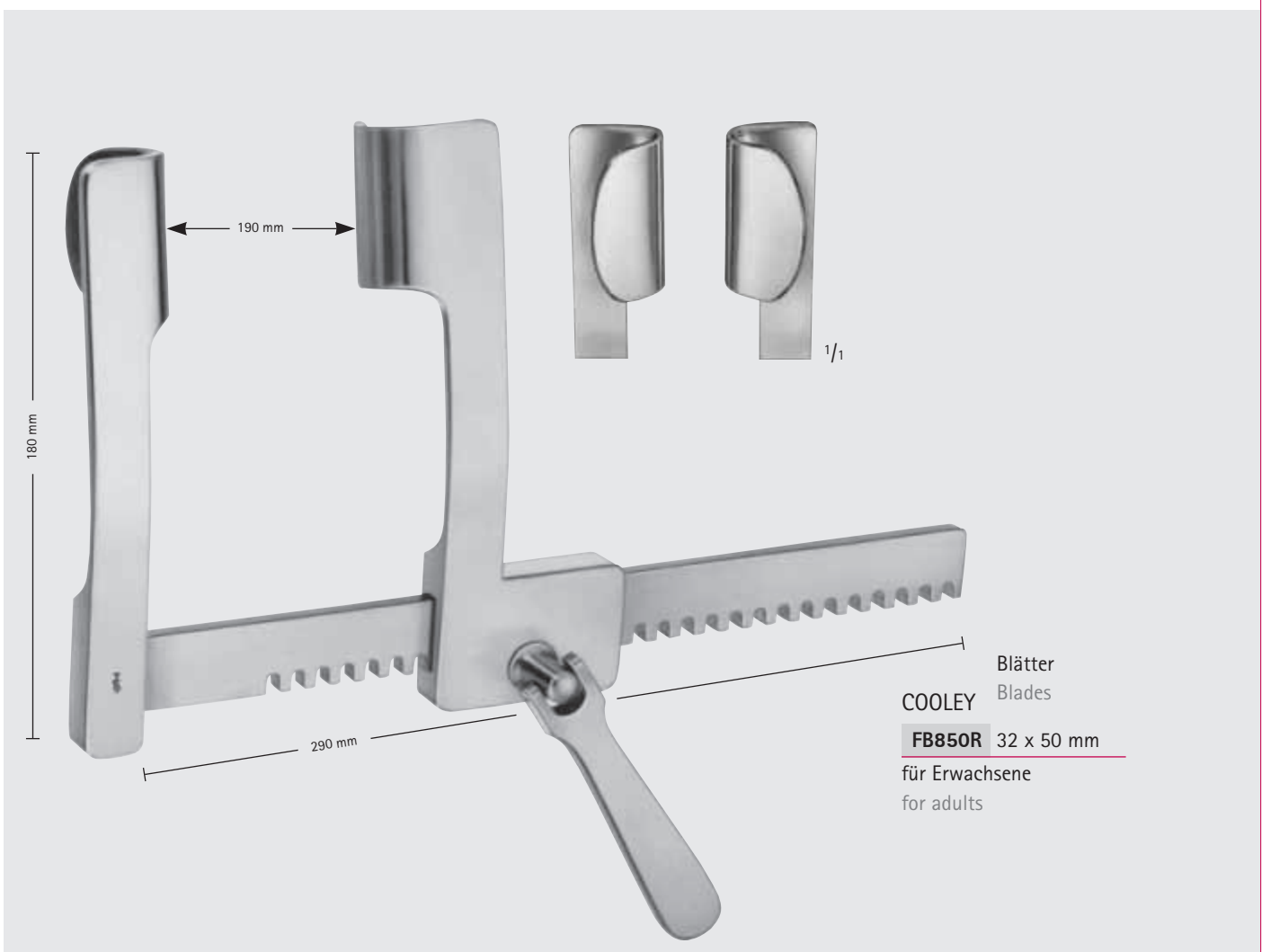

Blätter
Blades

COOLEY **FB850R** 32 x 50 mm

für Erwachsene
for adults



Herz- und Gefäß-Chirurgie – Cardiovascular Surgery

Thoraxsperrer

Thoracic Retractor

FB



FB823R 75 x 75 mm

Blätter

Blades

1/1



FB822R 42 x 65 mm

Blätter

Blades

1/1

FB820R

Thoraxsperrer (Mercedes-Sperrer) komplett, bestehend aus:

FB821R Sperrer allein

FB822R Blätter (Paar)

FB823R Blätter (Paar)

Thoracic retractor (Mercedes-Retractor)

complete, consisting of:

FB821R Retractor only

FB822R Blades (pair)

FB823R Blades (pair)

1/2

Herz- und Gefäß-Chirurgie – Cardiovascular Surgery

Sternum-Sperrer Sternum Retractors

Der Sperrer kann optional nach kranial (Bild 2, 2a) und kaudal (Bild 1, 1a) eingesetzt werden, wobei beim Einsatz nach kranial die Aufbiegung der Arme nach oben, vom Patienten weg zeigt, um Druck auf den Hals zu vermeiden.

The spreader can be used optionally in cranial (picture 2, 2a) or caudal (picture 1, 1a) position. As the retractor is used in cranial position the bend up arms show away from the patient in order to protect the neck from pressure.



1

Einsatz als Sternumsperrer (Bild 1, 2)

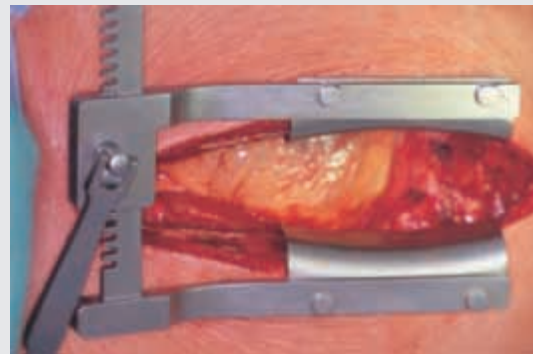

2

Used as sternum retractor (picture 1, 2)



1a

Einsatz zur Darstellung der Arteria mammaria interna (Bild 1a, 2a).

Die Seite des Sternums, auf der die Arteria mammaria interna präpariert werden soll, wird durch die Spreizwirkung des Sperrers automatisch angehoben. Das Ergebnis ist eine einfachere Präparation der Arteria mammaria interna.

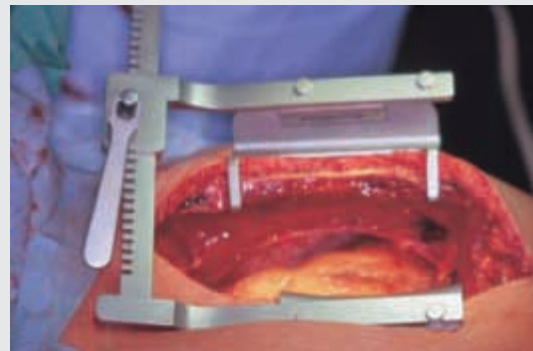

2a

Used for preparation of the arteria mammaria interna (picture 1a, 2a).

The side of the sternum, where the arteria mammaria interna shall be dissected is lifted up automatically due to the spreading effect of the retractor. The result is an easier preparation of the arteria mammaria interna.

Herz- und Gefäß-Chirurgie – Cardiovascular Surgery

Sternum-Sperrer

Sternum Retractors

FB

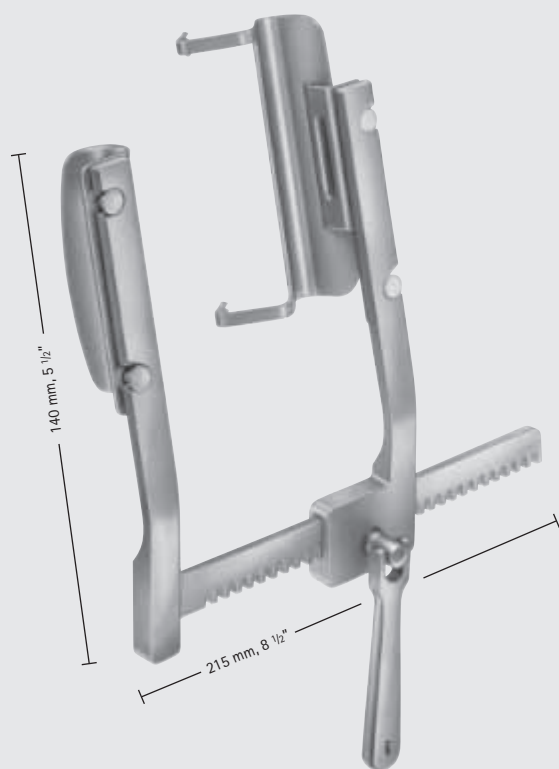

FC060R

Mammia Sperrer komplett,
bestehend aus:

- FC061R Sperrer allein
- FC062R Mammia-blatt, komplett mit
Aufnahmeblatt links und rechts
- FC063R Sternumblätter (Paar)
- FC064R Sternumblätter (Paar)

Mammia spreader complete,
consisting of:

- FC061R Retractor only
- FC062R Mammia-blade complete with
holding blades left and right
- FC063R Sternum blades (pair)
- FC064R Sternum blades (pair)

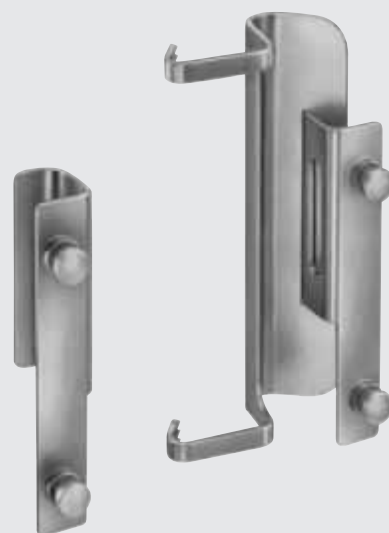

FC062R

Mammia-blatt, komplett
Mammia blade, complete



FC063R 30 x 100 mm

Sternumblätter
Sternum blades



FC064R 40 x 100 mm

Sternumblätter
Sternum blades



Herz- und Gefäß-Chirurgie – Cardiovascular Surgery

Rippensperrer und -Kontraktoren Rib Spreaders- and Contractors

FB



SELLORS

FB840R

Rippensperrer und -kontraktor
mit drehbaren Klauen

Rib spreader- and contractor
with swivel blades

200 mm, 8"



BAILEY

FB844R

150 mm, 6"



FB841R

für Kinder
for children

FB842R

für Erwachsene
for adults

BAILEY

FB841R-FB842R

200 mm, 8"

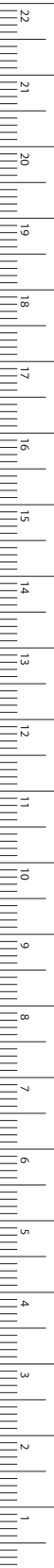

MILLIMETERS

Herz- und Gefäß-Chirurgie – Cardiovascular Surgery

Wundhaken, Lungenspatel

Retractors, Lung Spatulas

Weitere Wundhaken siehe Rubrik BT

Further retractors see section BT

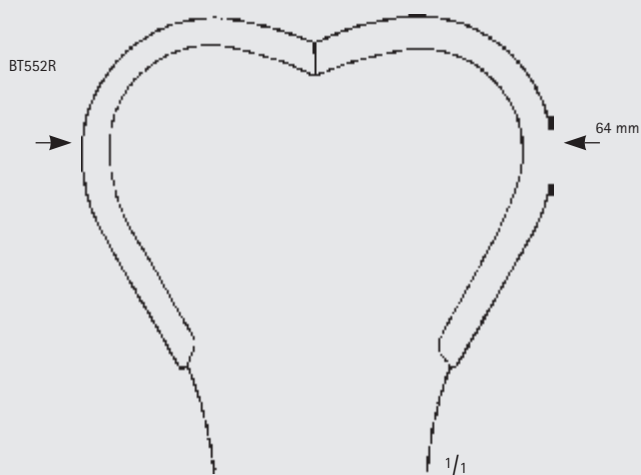
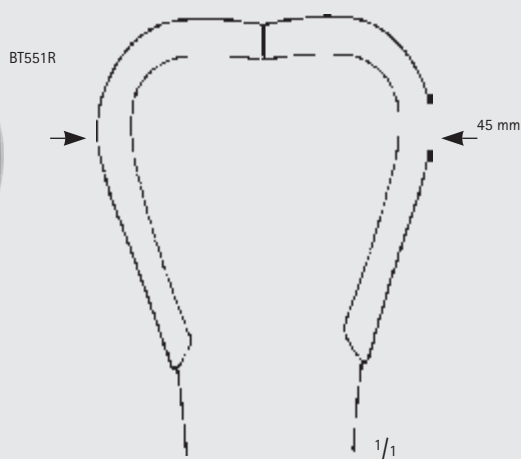

HARRINGTON

BT551R 123 x 45 mm

BT552R 123 x 64 mm

federnd

flexible

295 mm, 11 3/4"

INCHES



Herz- und Gefäß-Chirurgie – Cardiovascular Surgery

Wundhaken, Lungenspatel
Retractors, Lung Spatulas

Weitere Wundhaken siehe Rubrik BT
Further retractors see section BT



HARRINGTON-PEMBERTON

BT553R 175 x 64 mm

federnd

flexible

295 mm, 11 ³/₄"

FB



MILLIMETERS

Herz- und Gefäß-Chirurgie – Cardiovascular Surgery

Scapula-Haken

Scapula Retractor

FB

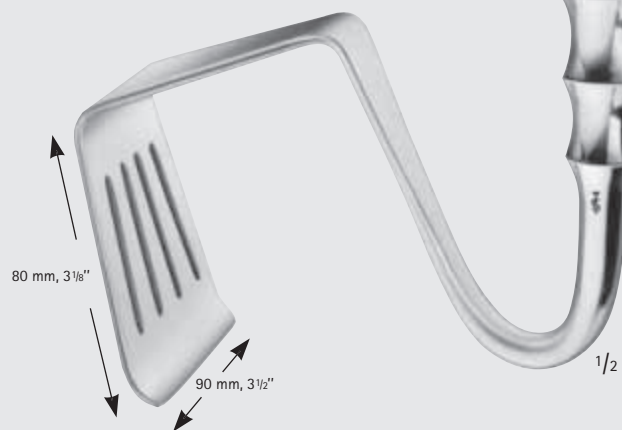
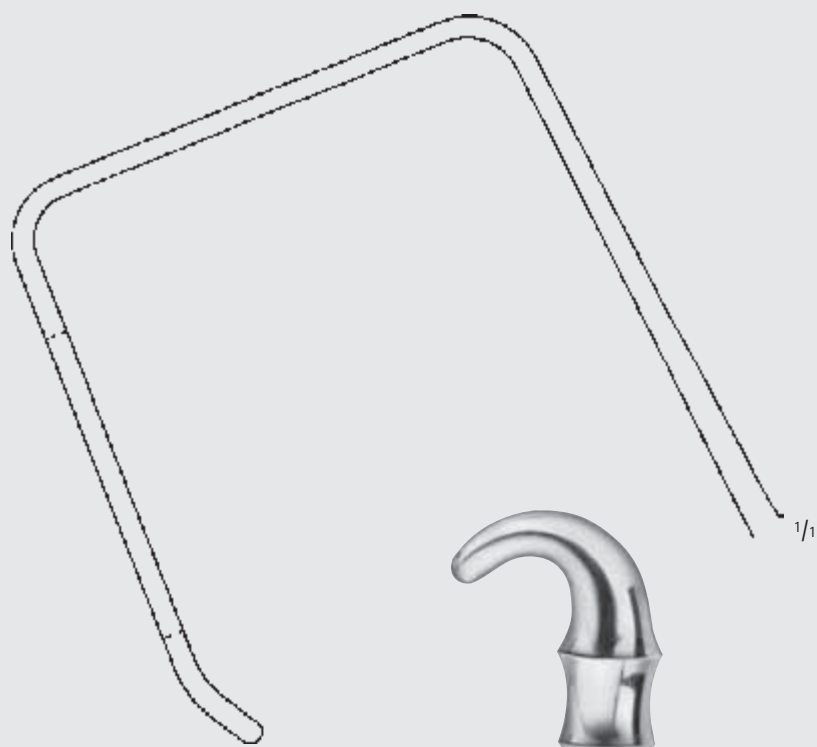

DAVIDSON

BT531R

195 mm, 7 3/4"



Herz- und Gefäß-Chirurgie – Cardiovascular Surgery

Lungenspatel
Lung Spatulas

FB



ALLISON

BT559R

255 mm, 10"

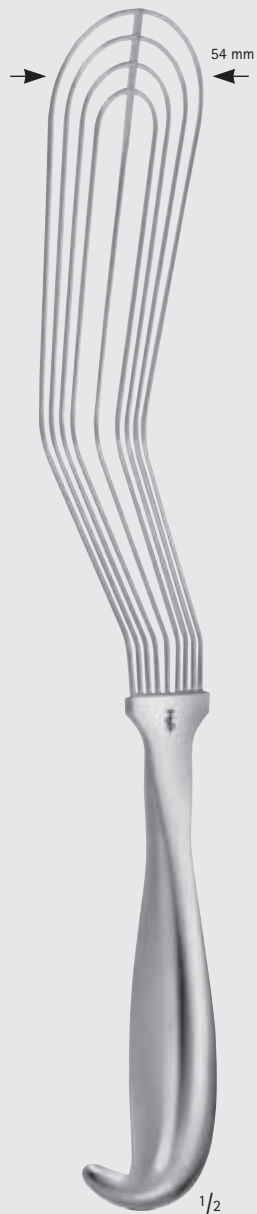

ALLISON

BT560R

320 mm, 12 3/4"

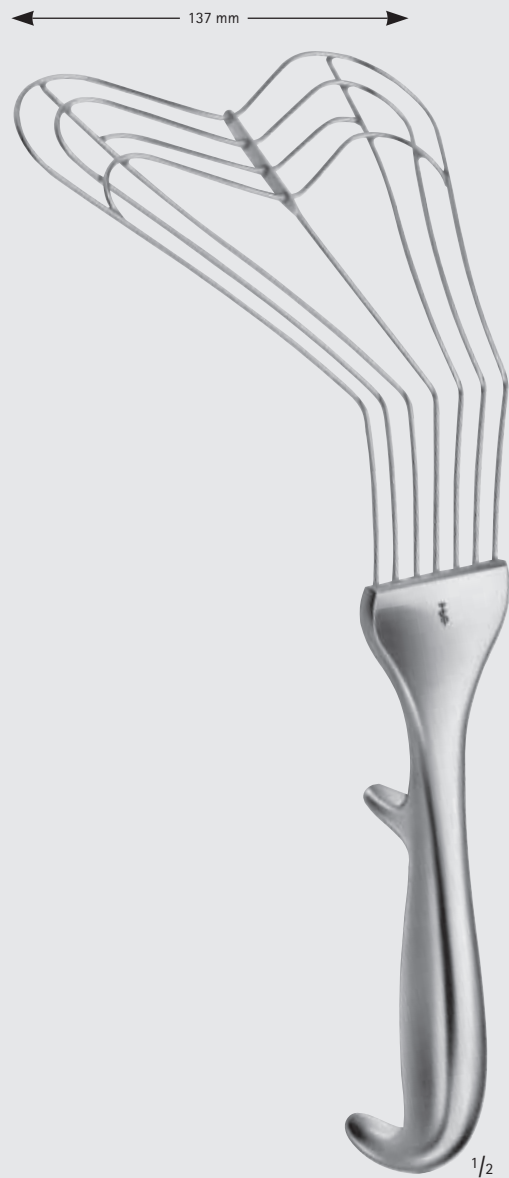

ALLISON

BT561R

300 mm, 12"



MILLIMETERS

Herz- und Gefäß-Chirurgie – Cardiovascular Surgery

Atriumhaken

Atrium Retractors

FB



45 x 48 mm

COOLEY

FB860R

rechts
right

270 mm, 10 ³/₄"



45 x 48 mm

COOLEY

FB861R

rechts, leicht gezahnt
right, slightly serrated

270 mm, 10 ³/₄"



25 x 46 mm

COOLEY

FB862R

links
left

280 mm, 11"



Herz- und Gefäß-Chirurgie – Cardiovascular Surgery

Atriumhaken
Atrium Retractors

FB



45 x 30 mm

COOLEY MODIF. STRUCK

FB865R

leicht gezahnt
slightly serrated
265 mm, 10 1/2"



45 x 35 mm

COOLEY MODIF. STRUCK

FB866R

leicht gezahnt
slightly serrated
265 mm, 10 1/2"

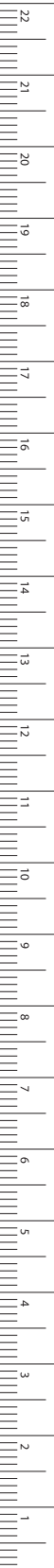

MILLIMETERS

Herz- und Gefäß-Chirurgie – Cardiovascular Surgery

Aortenklappenhaken

Aorta Valve Retractors

FB

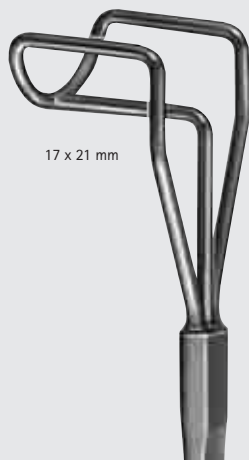

17 x 21 mm

FB971R

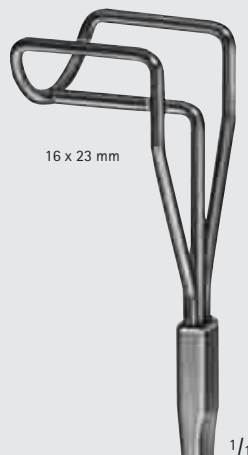

16 x 23 mm

FB972R



20 x 25 mm

FB973R

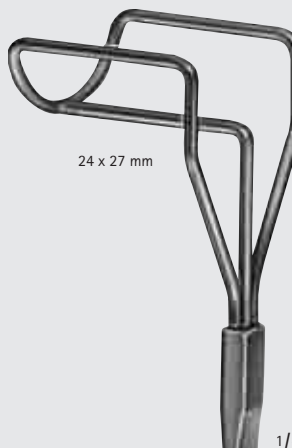

24 x 27 mm

FB974R

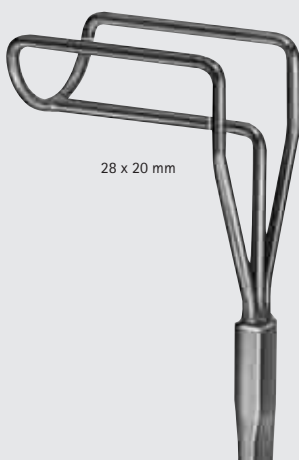

28 x 20 mm

FB975R

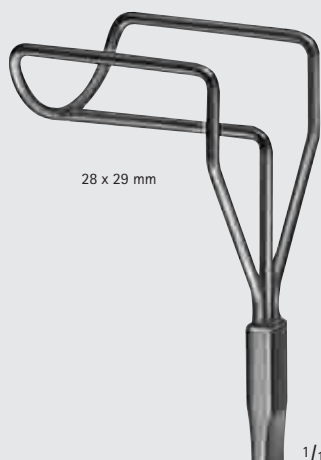

28 x 29 mm

FB976R



1/2

BOROWSKI

FB971R-FB976R

Schaft biegsam

Shaft malleable

270 mm, 10 3/4"



Herz- und Gefäß-Chirurgie – Cardiovascular Surgery

Saugkanülen Suction Cannulae

FB



Olive Ø 9 mm
olive diam. 9 mm

Ø 5 mm
diam. 5 mm

1/1



Olive Ø 9 mm
olive diam. 9 mm

Ø 5 mm
diam. 5 mm

1/1

DE BAKEY

GF947R 160 mm, 6 1/4"

GF948R 270 mm, 10 3/4"

mit Saugunterbrecher und Mandrin
with finger cut-off and stylet



Olive Ø 6 - 10 mm
olive diam. 6 - 10 mm

Ø 9 mm
diam. 9 mm

1/1

DE BAKEY

GF946R

mit zentraler Bohrung, Ø 3,0 mm
und seitlichen Schlitzen
with central bore, 3.0 mm diam.
with lateral slots
275 mm, 10 3/4"



Olive Ø 7 - 9 mm
olive diam. 7 - 9 mm

Ø 10 mm
diam. 10 mm

YANKAUER

GF944R

mit zentraler Bohrung, Ø 2,0 mm
with central bore, 2.0 mm diam.
285 mm, 11 1/4"



MILLIMETERS

Herz- und Gefäß-Chirurgie – Cardiovascular Surgery

Saugkanülen

Suction Cannula

FB

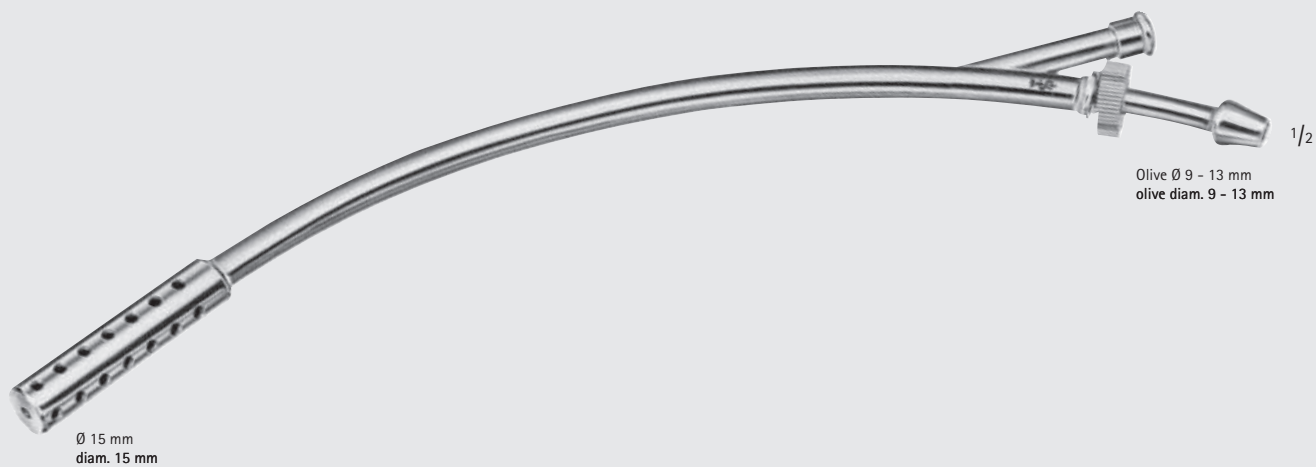

Ø 15 mm
diam. 15 mm

Olive Ø 9 - 13 mm
olive diam. 9 - 13 mm

FINSTERER

GF867C

kombinierte Saug- und Spülkanüle

combined suction- and irrigation cannula

320 mm, 12 3/4"





Herz- und Gefäß-Chirurgie – Cardiovascular Surgery

Venen-Stripper-Instrumente

Vein Stripper Instruments

FB

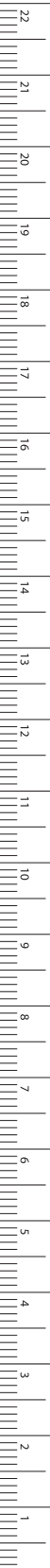

Ersatzteile für FB030R
Spare parts for FB030R



NABATOFF

FB033

Kunststoff-Sondenspitze
Flexible plastic probe tip



NABATOFF

1/1

Ø
diam.

FB034R 3 mm

Metall-Sondenspitze
Probe tip, metal



NABATOFF

FB030R

Venenstripper-Besteck, bestehend aus:

- FB031R Metalletui
- FB032R Zugseil, 900 mm lang
- FB033 Kunststoff-Sondenspitze
- FB034R Metall-Sondenspitze
- FB035R Metallolive, Ø 6 mm
- FB036R Metallolive, Ø 9 mm
- FB037R Metallolive, Ø 12 mm
- FB038R Metallolive, Ø 15 mm
- FB040R Griff für Zugseil

Vein stripper set, consisting of:

- FB031R Metal case
- FB032R Flexible cable, 36" long
- FB033 Flexible plastic probe tip
- FB034R Metal probe tip
- FB035R Metal olive, diam. 6 mm
- FB036R Metal olive, diam. 9 mm
- FB037R Metal olive, diam. 12 mm
- FB038R Metal olive, diam. 15 mm
- FB040R Handle for flexible cable

NABATOFF

Ø
diam.

FB035R 6 mm

FB036R 9 mm

FB037R 12 mm

FB038R 15 mm

Oliven allein

Olives only



FB035R



FB036R



FB037R



FB038R

1/1



NABATOFF

FB040R

Griff allein

Handle only



FB032R

Zugseil
Flexible cable
900 mm, 36"

MILLIMETERS

Herz- und Gefäß-Chirurgie – Cardiovascular Surgery

Varizeninstrumente

Varix Instruments

FB

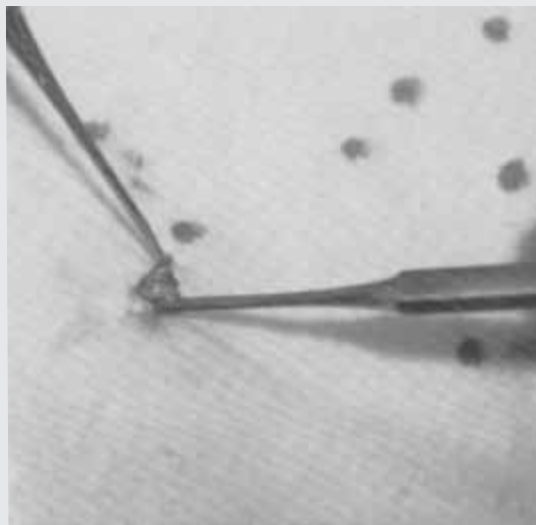

VARADY

FB050R

Mini-Venenstripper-Set, bestehend aus:

- FB031R Metalletui
- FB051R Zugseil, 450 mm lang, kunststoffummantelt
- FB053R Metallolive, Ø 3 mm
- FB054R Metallolive, Ø 4 mm
- FB055R Metallolive, Ø 5 mm

Mini vein stripper set, consisting of:

- FB031R Metal case
- FB051R Flexible cable, 17 1/2" long, polyethylene coating
- FB053R Metal olive, diam. 3 mm
- FB054R Metal olive, diam. 4 mm
- FB055R Metal olive, diam. 5 mm

Ersatzteile für FB050R
Spare parts for FB050R

VARADY

Ø
diam.

FB053R	3 mm
FB054R	4 mm
FB055R	5 mm

Oliven allein
Olives only



FB053R



FB054R

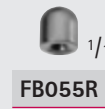

FB055R 1/1



VARADY

FB051R

Zugseil, kunststoffummantelt
Cable, flexible, polyethylene coating
450 mm, 17 1/2"



Herz- und Gefäß-Chirurgie – Cardiovascular Surgery

Varizeninstrumente

Varix Instruments

FB

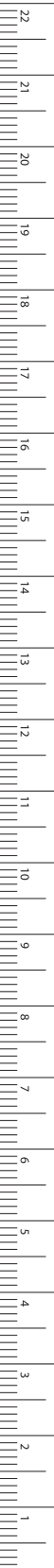

MILLIMETERS



VARADY

FB120R

Phlebodissektor
Phlebodissector
180 mm, 7"

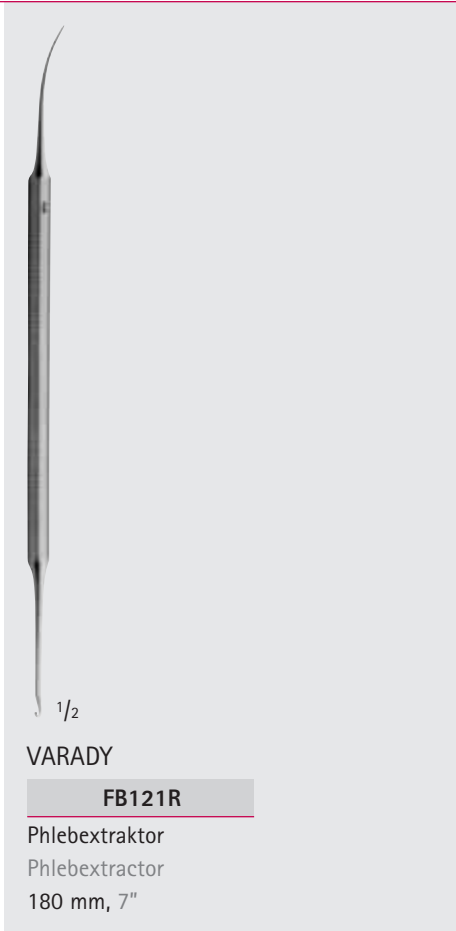

VARADY

FB121R

Phlebextractor
Phlebextractor
180 mm, 7"

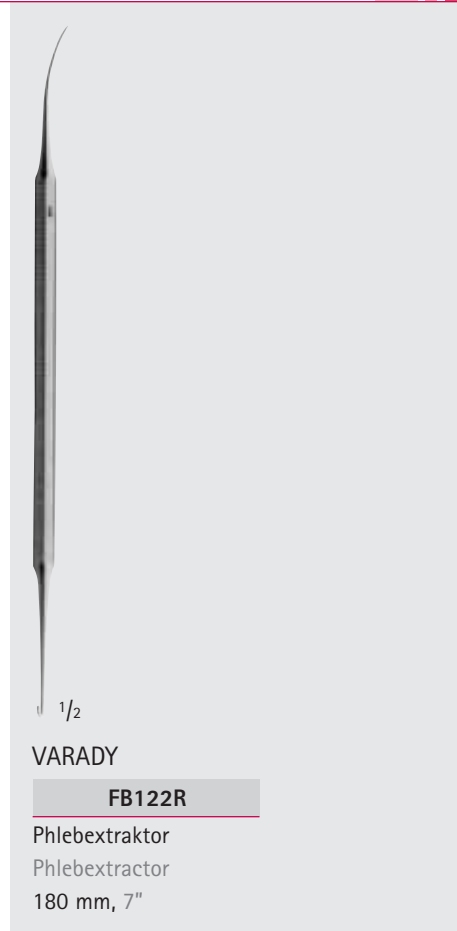

VARADY

FB122R

Phlebextractor
Phlebextractor
180 mm, 7"

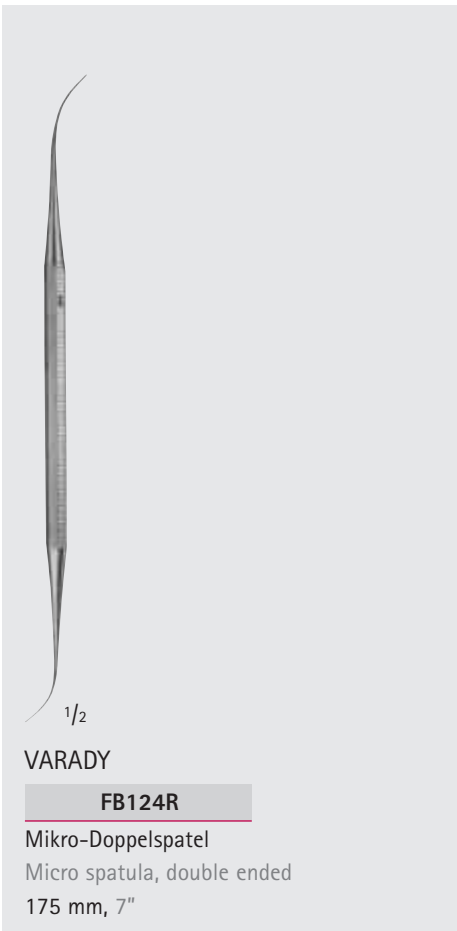

VARADY

FB124R

Mikro-Doppelspatel
Micro spatula, double ended
175 mm, 7"



VARADY

FB125R

Mikro-Phlebextractor
Micro phlebextractor
170 mm, 6 3/4"



VARADY

FB126R

Mini-Phlebextractor
Mini phlebextractor
170 mm, 6 3/4"

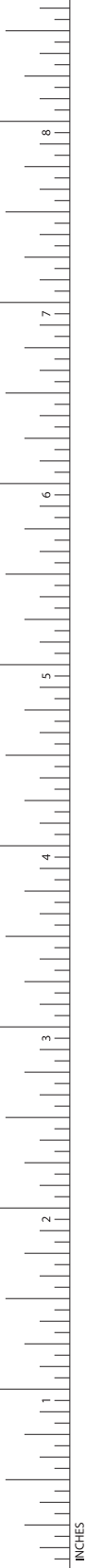

INCHES

FF



Knochenstanzen, Rongeurs
Bone Punches, Rongeurs

Knochenstanzen, Rongeurs – Bone Punches, Rongeurs

Stanzen
Punches

Winkelstellungen bei Stanzen
Angled positions for punches

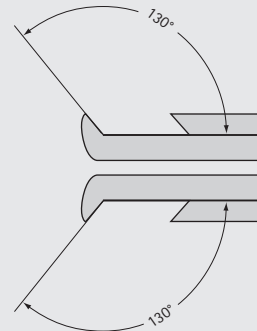
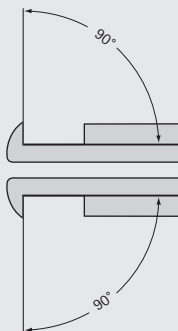
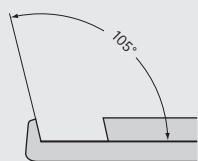

90° nach oben schneidend
upwards cutting

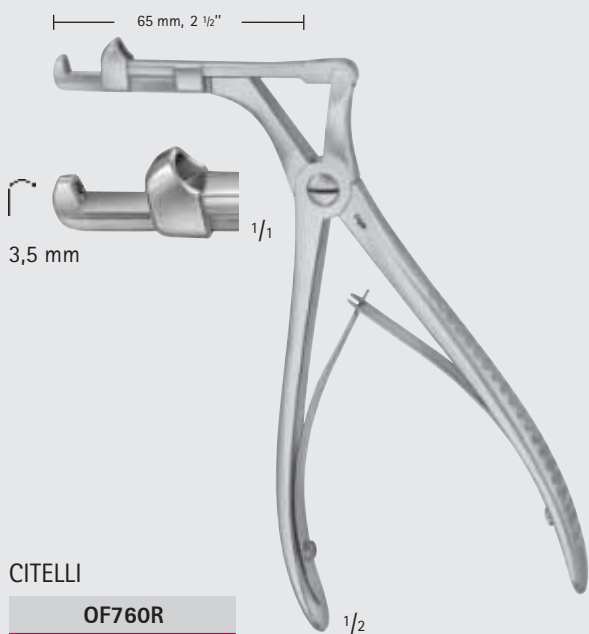

90° nach oben schneidend
upwards cutting

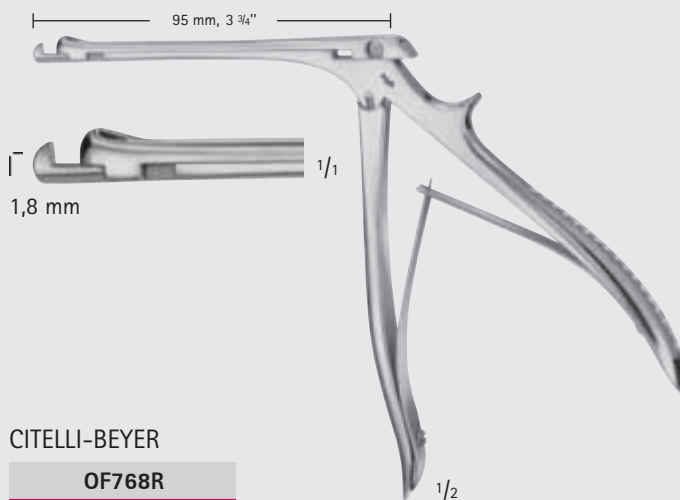

90° nach oben schneidend
upwards cutting

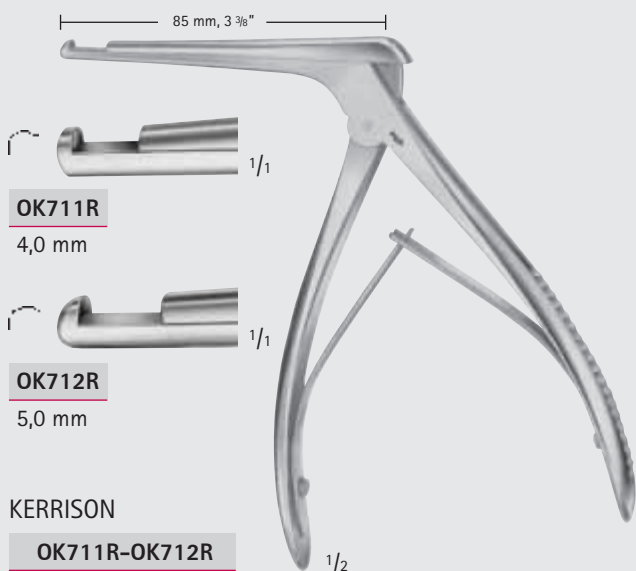

FF





Knochenstanzen, Rongeurs – Bone Punches, Rongeurs

Stanzen
Punches

FF

90° nach oben schneidend
upwards cutting

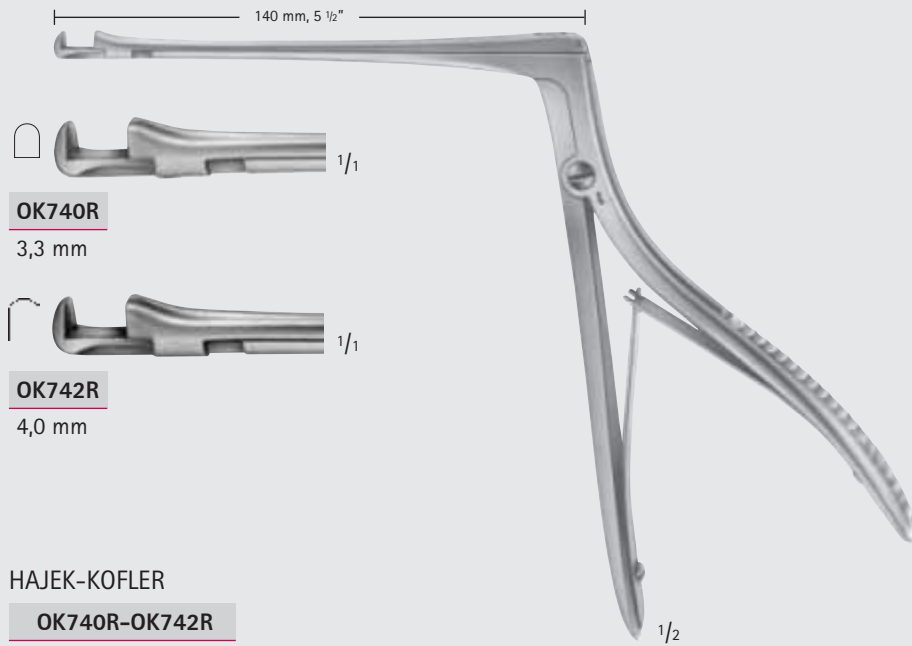

90° nach unten schneidend
downwards cutting

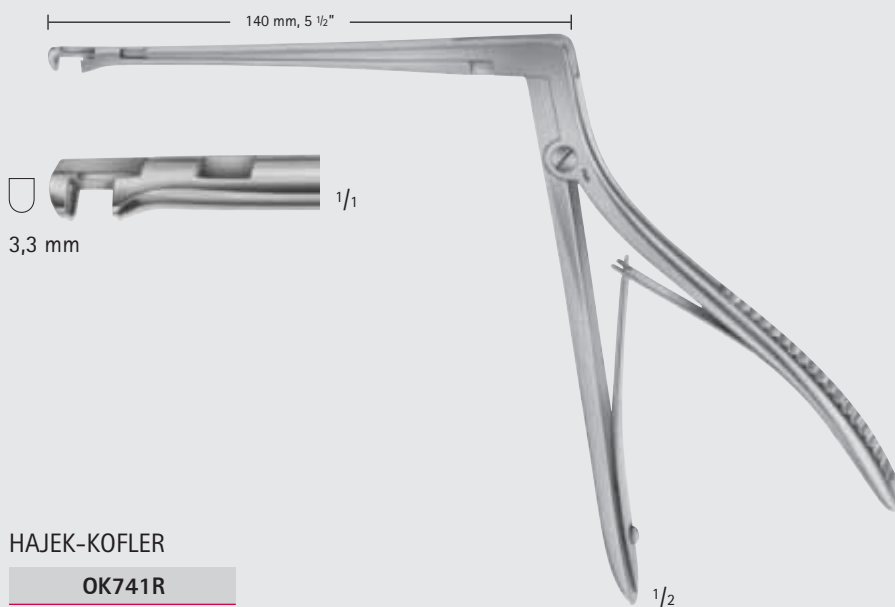

MILLIMETERS

Knochenstanzen, Rongeurs – Bone Punches, Rongeurs

Stanzen
Punches

90° drehbar 360°
rotates 360°

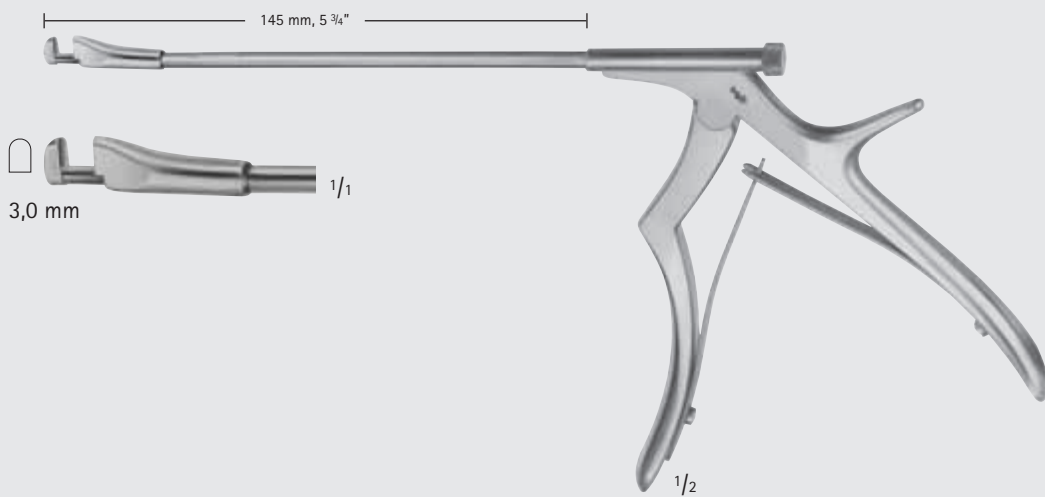

KOFLER

OK737R

90° drehbar 360°
rotates 360°

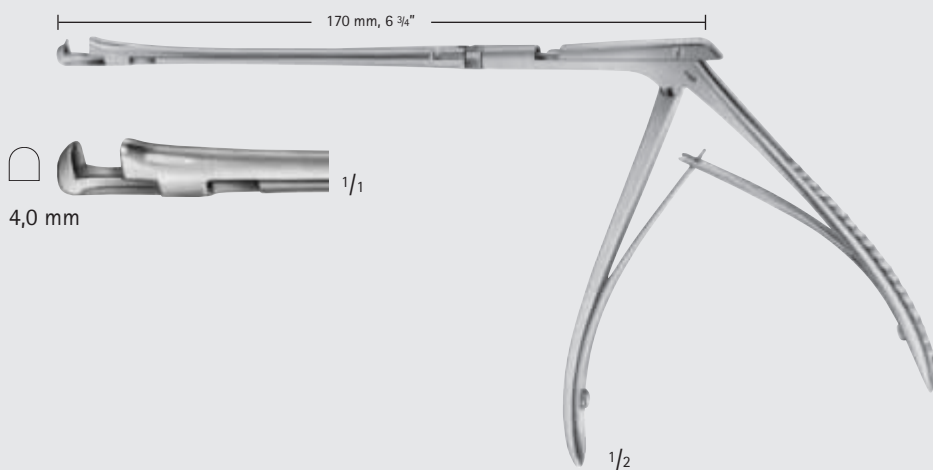

HAJEK-KOFLER

OK745R



Knochenstanzen, Rongeurs – Bone Punches, Rongeurs

Stanzen
Punches

FF

130° nach oben schneidend
upwards cutting

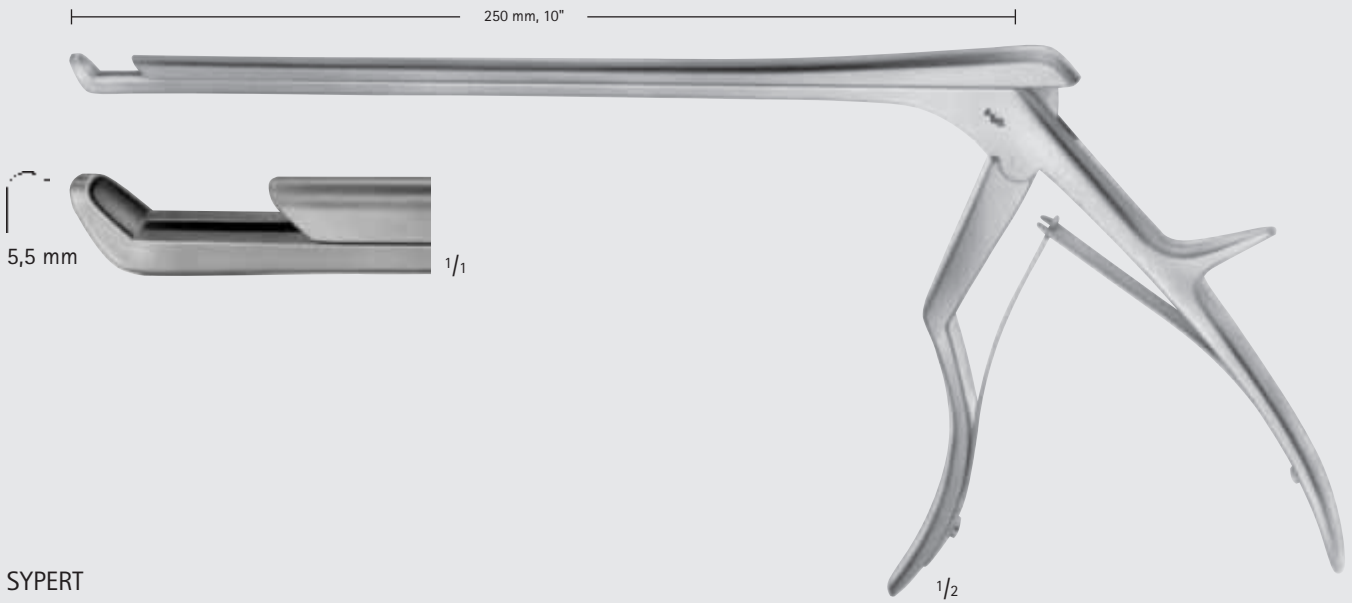

SYPERT

FG055R

MILLIMETERS

Knochenstanzen, Rongeurs – Bone Punches, Rongeurs

KERRISON Knochenstanzen

KERRISON Bone Punches

90° nach oben schneidend
upwards cutting



Regular



90° oben
90° upwards

90° oben
90° upwards

90° oben
90° upwards

STANDARD
nicht zerlegbar
ohne Ejektor
non detachable
without ejector

zerlegbar
detachable

Ejektor
Ejector

NOIR
zerlegbar
detachable

Ejektor
Ejector

Schaftlänge
Shaft length

Breite
Width

Fußplatte
Footplate

180 mm, 7"

1,0 mm

regular

FF716R

FK948R

-

FK948B

-

2,0 mm

regular

FF718R

FK949R

-

FK949B

-

3,0 mm

regular

FF750R

FK950R



FK950B



4,0 mm

regular

FF752R

FK951R



FK951B



5,0 mm

regular

FF754R

FK952R



FK952B



6,0 mm

regular

FF755R

FK953R



FK953B



90° nach unten schneidend
downwards cutting



Regular



90° unten
90° downwards

90° unten
90° downwards

STANDARD
nicht zerlegbar,
ohne Ejektor
non detachable,
without ejector

zerlegbar
detachable

Ejektor
Ejector

Schaftlänge
Shaft length

Breite
Width

Fußplatte
Footplate

180 mm, 7"

1,0 mm

regular

FF741R

FK954R

-

2,0 mm

regular

FF719R

FK955R

-

3,0 mm

regular

FF721R

FK956R



4,0 mm

regular

FF742R

FK957R



5,0 mm

regular

FF723R

FK958R



6,0 mm

regular

FF743R

FK959R





Knochenstanzen, Rongeurs – Bone Punches, Rongeurs

KERRISON Knochenstanzen

KERRISON Bone Punches

130° nach oben schneidend
upwards cutting



Regular

Thin



130° oben
130° upwards

130° oben
130° upwards

130° oben
130° upwards

STANDARD
nicht zerlegbar
ohne Ejektor
non detachable
without ejector

zerlegbar
detachable

Ejektor
Ejector

NOIR
zerlegbar
detachable

Ejektor
Ejector

Schaftlänge Shaft length	Breite Width	Fußplatte Footplate					
180 mm, 7"	1,0 mm	regular	FF715R	FK900R	-	FK900B	-
	2,0 mm	regular	FF717R	FK901R	-	FK901B	-
	3,0 mm	regular	FF720R	FK902R	☐	FK902B	☐
	4,0 mm	regular	FF724R	FK903R	☐	FK903B	☐
	5,0 mm	regular	FF722R	FK904R	☐	FK904B	☐
	6,0 mm	regular	FF726R	FK905R	☐	FK905B	☐
200 mm, 8"	2,0 mm	regular	FF737R	FK913R	-	FK913B	-
	3,0 mm	regular	FF738R	FK914R	☐	FK914B	☐
	4,0 mm	regular	FF727R	FK915R	☐	FK915B	☐
	5,0 mm	regular	FF728R	FK916R	☐	FK916B	☐
	6,0 mm	regular	FF729R	FK917R	☐	FK917B	☐
230 mm, 9"	2,0 mm	regular	FF682R	FK919R	-		
	3,0 mm	regular	FF683R	FK920R	☐		
	4,0 mm	regular	FF684R	FK921R	☐		
	5,0 mm	regular	FF685R	FK922R	☐		
180 mm, 7"	1,0 mm	thin	FF771R	FK906R	-	FK906B	-
	2,0 mm	thin	FF772R	FK907R	-	FK907B	-
	3,0 mm	thin	FF773R	FK908R	☐	FK908B	☐
	4,0 mm	thin	FF769R	FK909R	☐	FK909B	☐
	5,0 mm	thin	FF770R	FK910R	☐	FK910B	☐
200 mm, 8"	1,0 mm	thin	FF661R	FK961R	-	FK961B	-
	2,0 mm	thin	FF662R	FK962R	-	FK962B	-
	3,0 mm	thin	FF663R	FK963R	☐	FK963B	☐
	4,0 mm	thin	FF664R	FK964R	☐	FK964B	☐
	5,0 mm	thin	FF665R	FK965R	☐	FK965B	☐
230 mm, 9"	2,0 mm	thin	FF746R	FK925R	-	FK925B	-
	3,0 mm	thin	FF747R	FK926R	☐	FK926B	☐
	4,0 mm	thin	FF748R	FK927R	☐	FK927B	☐
	5,0 mm	thin	FF749R	FK928R	☐	FK928B	☐

FF



MILLIMETERS

Knochenstanzen, Rongeurs – Bone Punches, Rongeurs

KERRISON Knochenstanzen

KERRISON Bone Punches

130° nach unten schneidend
downwards cutting



Regular

Thin



130° unten
130° downwards

130° unten
130° downwards

STANDARD
nicht zerlegbar
ohne Ejektor
non detachable
without ejector

zerlegbar
detachable

Ejektor
Ejector

Schaftlänge Shaft length	Breite Width	Fußplatte Footplate			
180 mm, 7"	1,0 mm	regular	FF711R	FK930R	-
	2,0 mm	regular	FF712R	FK931R	-
	3,0 mm	regular	FF713R	FK932R	
	4,0 mm	regular	FF714R	FK933R	
	5,0 mm	regular	FF725R	FK934R	
230 mm, 9"	2,0 mm	regular	FF692R	FK943R	-
	3,0 mm	regular	FF693R	FK944R	
	4,0 mm	regular	FF694R	FK945R	
	5,0 mm	regular	FF695R	FK946R	
180 mm, 7"	1,0 mm	thin	FF781R	FK936R	-
	2,0 mm	thin	FF782R	FK937R	-
	3,0 mm	thin	FF783R	FK938R	
	4,0 mm	thin	FF784R	FK939R	
	5,0 mm	thin	FF785R	FK940R	

FF



INCHES



Knochenstanzen, Rongeurs – Bone Punches, Rongeurs

Rongeurs
Rongeurs

Winkelstellungen bei Rongeurs
Angled positions for rongeurs

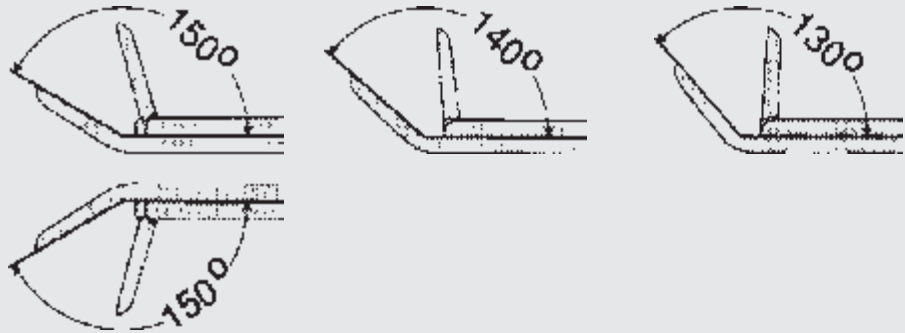

FF

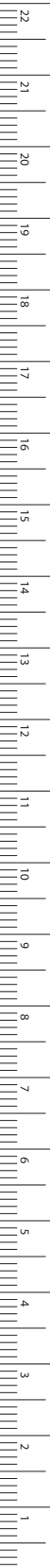

OK505R

3,0 mm



OK506R

3,6 mm



OK507R

4,2 mm



OK508R

4,8 mm



OK509R

5,6 mm

1/1

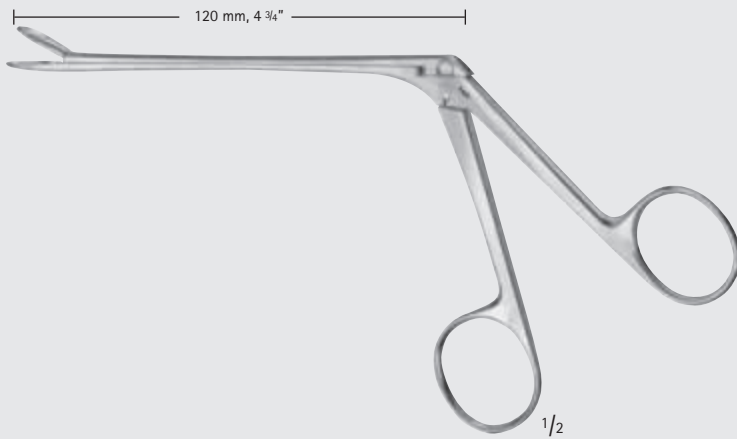

WEIL-BLAKESLEY

OK505R-OK509R

140°



OK520R

3,6 mm



OK521R

4,2 mm



OK522R

4,8 mm

1/1

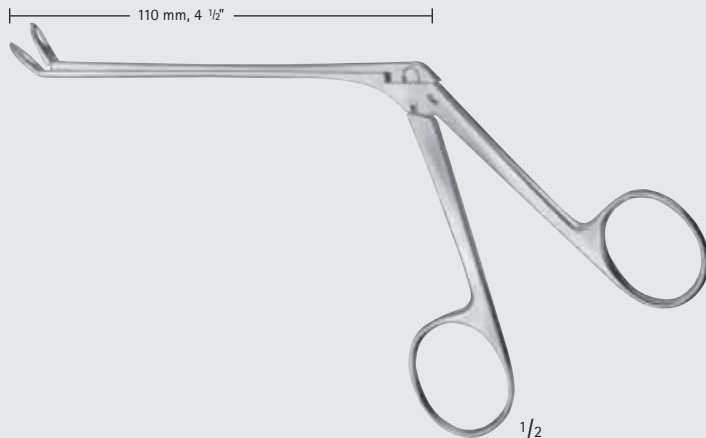

WEIL-BLAKESLEY

OK520R-OK522R

MILLIMETERS

Knochenstanzen, Rongeurs – Bone Punches, Rongeurs

Rongeurs

Rongeurs

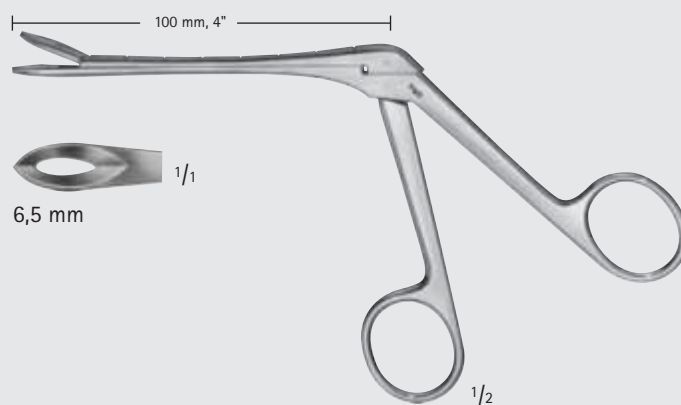

HENCKEL-TILLEY

OK503R

Schaft graduiert in cm

Shaft graduated in cm

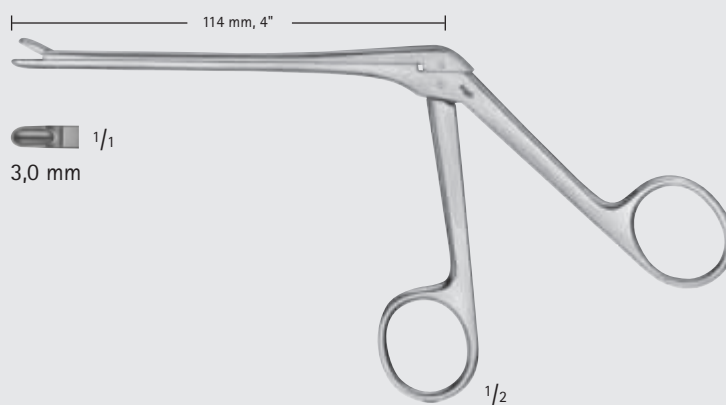

ST. BARTS

OK536R

140°

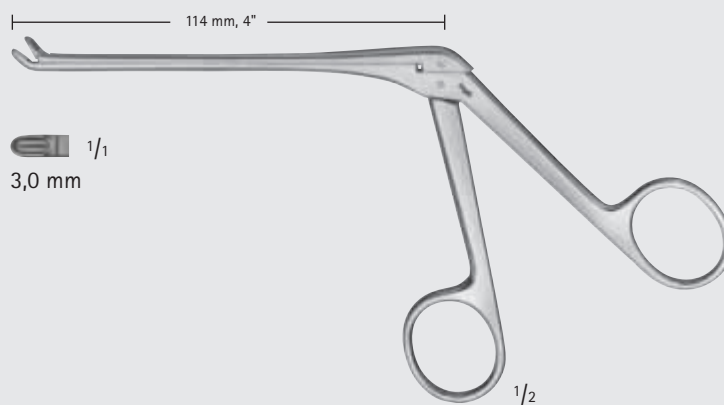

ST. BARTS

OK537R

FF





Knochenstanzen, Rongeurs – Bone Punches, Rongeurs

Rongeurs
Rongeurs

FF

140°

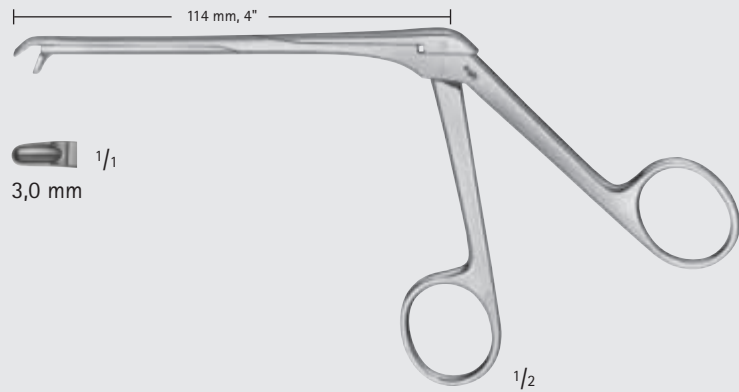

ST. BARTS

OK538R

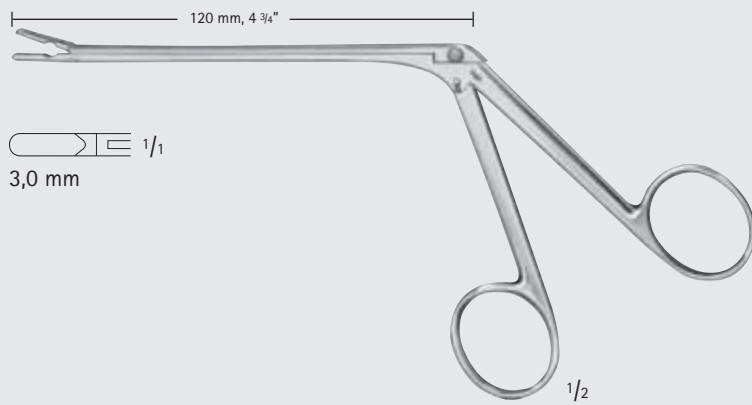

TAKAHASHI

OK525R

130°

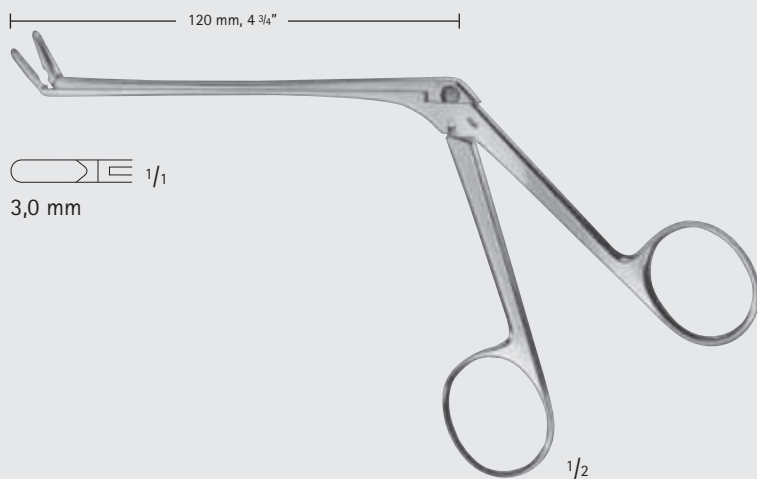

TAKAHASHI

OK526R



MILLIMETERS

Knochenstanzen, Rongeurs – Bone Punches, Rongeurs

Rongeurs

Rongeurs

FF

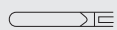

LOVE-GRUENWALD

FF799R

2 x 10 mm

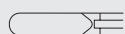

LOVE-GRUENWALD

FF800R

3 x 10 mm



SPURLING

FF801R

4 x 10 mm

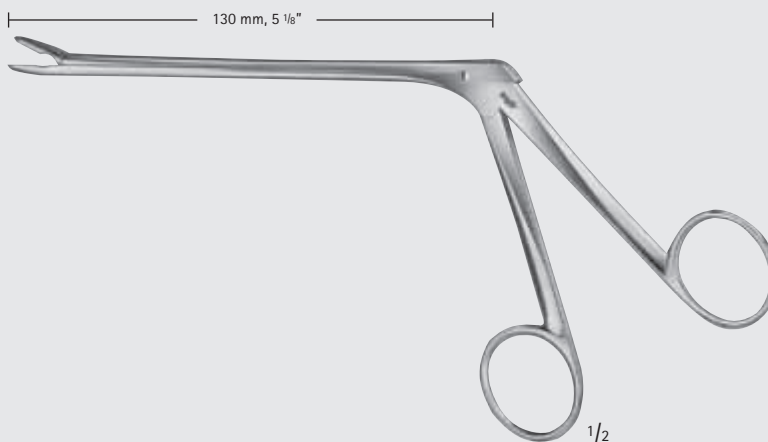

FF799R-FF810R



2,0 mm

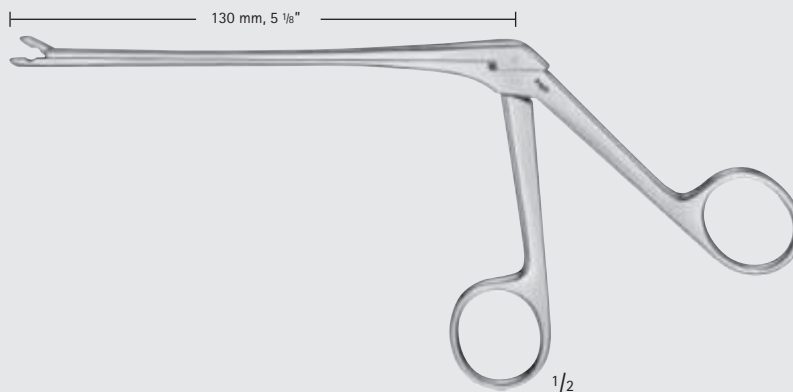

BECK

FF765R

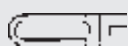

FF766R

4,0 mm



FF767R

5,0 mm

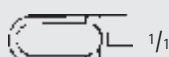

FF768R

6,0 mm

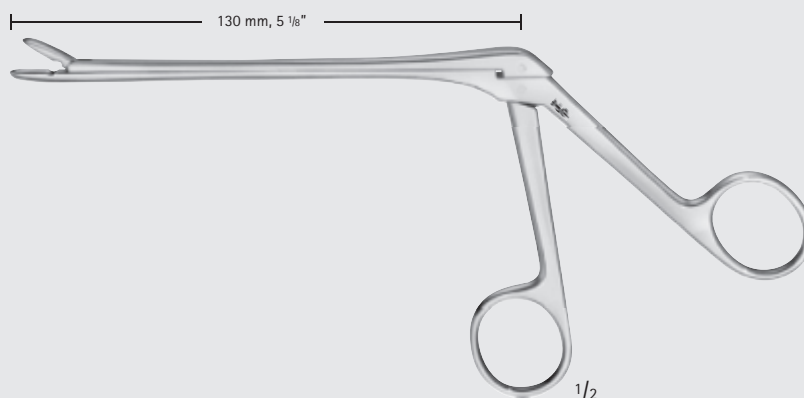

CUSHING

FF766R-FF768R





Knochenstanzen, Rongeurs – Bone Punches, Rongeurs

Rongeurs
Rongeurs

FF

150°

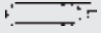

FF774R

3,0 mm



FF775R

4,0 mm

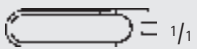

FF776R

5,0 mm

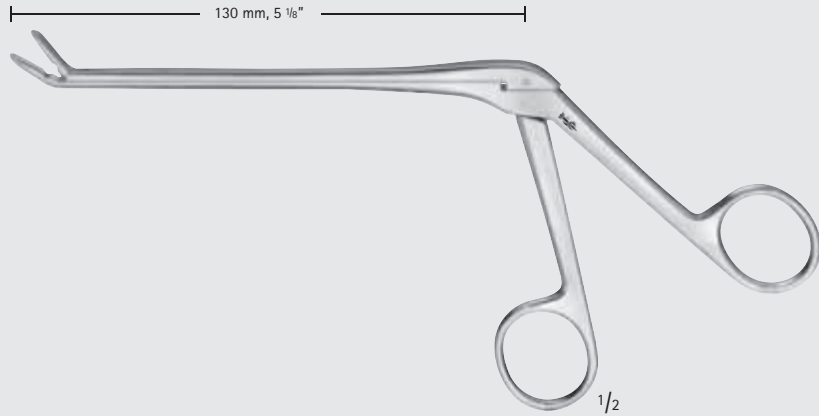

CUSHING

FF774R-FF776R

150°

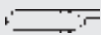

FF777R

3,0 mm



FF778R

4,0 mm

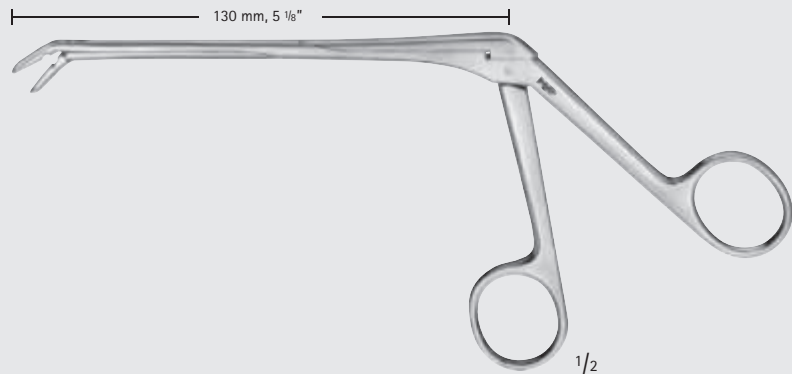

CUSHING

FF777R-FF778R

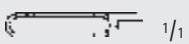

3,0 mm

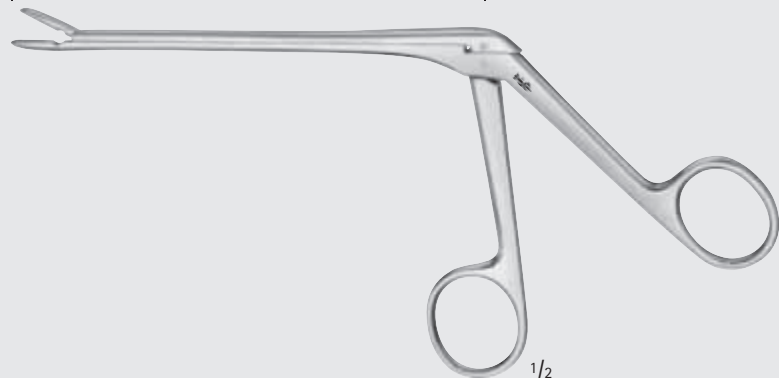
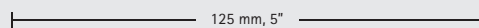

PENNYBACKER

FF779R

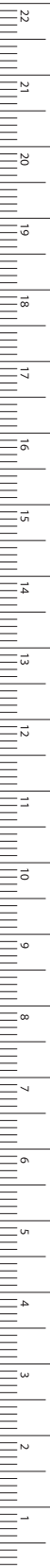

MILLIMETERS

Knochenstanzen, Rongeurs – Bone Punches, Rongeurs

Rongeurs

Rongeurs

FF



FF832R

2,0 mm

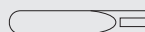

FF833R

3,0 mm



FF834R

4,0 mm

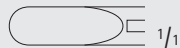

FF835R

5,0 mm

150 mm, 6"



CASPAR

FF832R-FF835R

150°

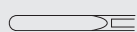

FF842R

2,0 mm



FF843R

3,0 mm

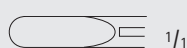

FF844R

4,0 mm

150 mm, 6"



CASPAR

FF842R-FF844R

150° unteres Maulteil beweglich
lower part of jaw movable



FF852R

2,0 mm

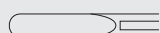

FF853R

3,0 mm

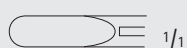

FF854R

4,0 mm

150 mm, 6"



CASPAR

FF852R-FF854R

INCHES



Knochenstanzen, Rongeurs – Bone Punches, Rongeurs

Rongeurs
Rongeurs



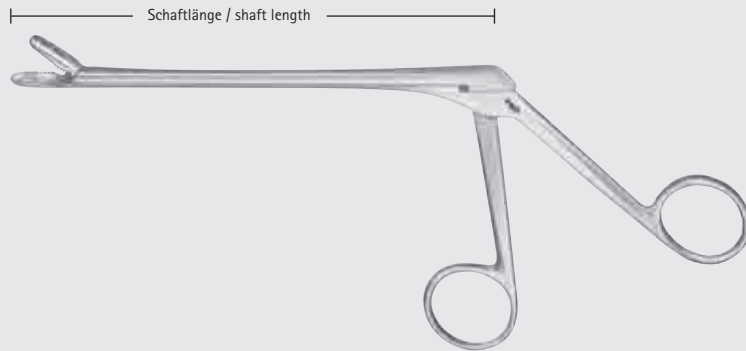

FF



CASPAR

FF502R-FF566R

Maulgröße
Jaw size

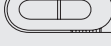
Schaftlänge Shaft length	 2 x 12 mm	 3 x 12 mm	 4 x 14 mm	 5 x 14 mm	 6 x 16 mm
140 mm, 5 1/2"	FF502R	FF503R	FF504R		
160 mm, 6 1/4"	FF532R	FF533R	FF534R	FF535R	FF536R
185 mm, 7 1/4"	FF562R	FF563R	FF564R	FF565R	FF566R

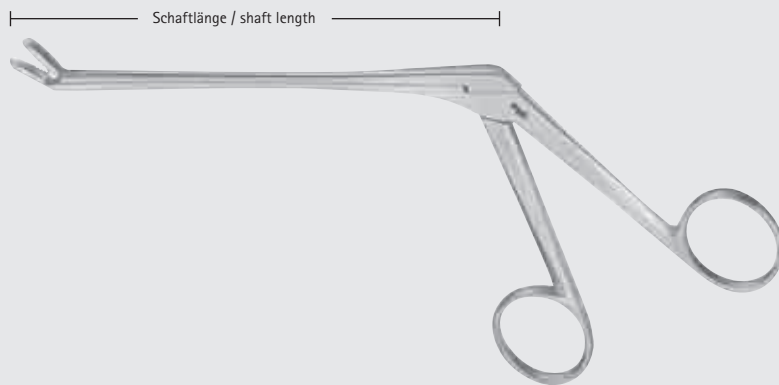

150°



CASPAR

FF513R-FF575R

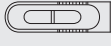
Maulgröße
Jaw size

Schaftlänge Shaft length	 3 x 12 mm	 4 x 14 mm	 5 x 14 mm
140 mm, 5 1/2"	FF513R	FF514R	
160 mm, 6 1/4"	FF543R	FF544R	FF545R
185 mm, 7 1/4"	FF573R	FF574R	FF575R



MILLIMETERS

Knochenstanzen, Rongeurs – Bone Punches, Rongeurs

Rongeurs

Rongeurs

150° unteres Maulteil beweglich
lower part of jaw movable

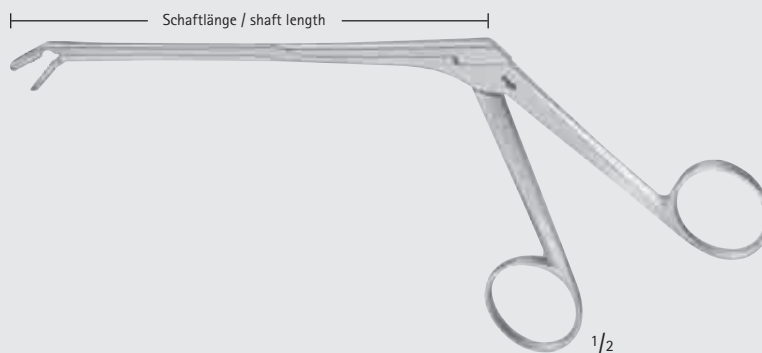



CASPAR

FF523R-FF584R

Maulgröße

Jaw size

Schaftlänge Shaft length	 3 x 12 mm	 4 x 14 mm ^{1/1}
140 mm, 5 1/2"	FF523R	FF524R
160 mm, 6 1/4"	FF553R	FF554R
185 mm, 7 1/4"	FF583R	FF584R

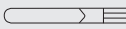
 CUSHING

FF803R

2 x 10 mm

 LOVE-GRUENWALD

FF805R

3 x 10 mm

 ^{1/1} SPURLING

FF807R

4 x 10 mm

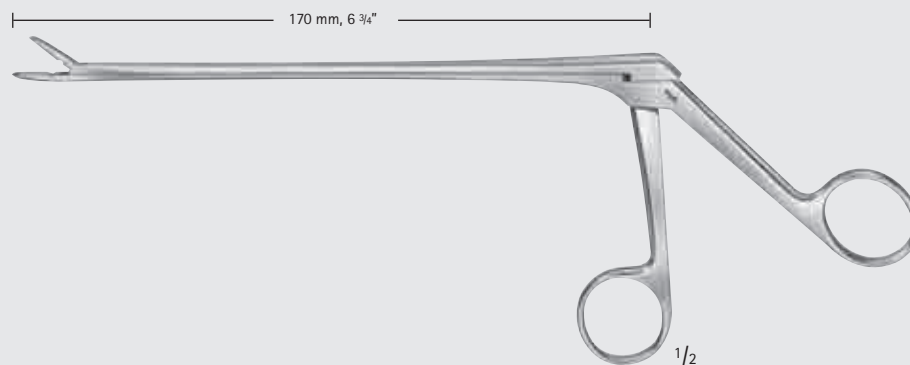

FF803R-FF807R



Knochenstanzen, Rongeurs – Bone Punches, Rongeurs

Rongeurs
Rongeurs

FF

150°

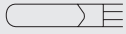

FF806R

3 x 10 mm



FF814R

4 x 10 mm

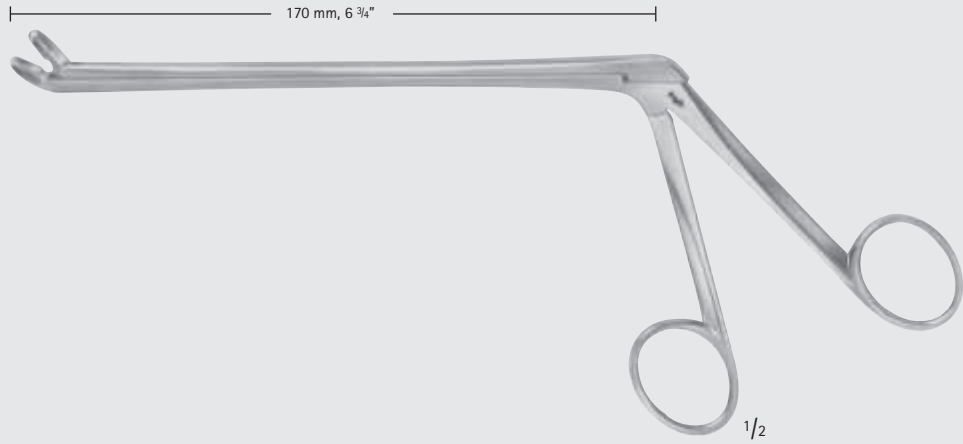

LOVE-GRUENWALD

FF806R-FF814R

150° oberes Maulteil beweglich
upper part of jaw movable

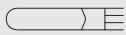

FF810R

3 x 10 mm

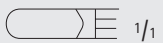

FF811R

4 x 10 mm



LOVE-GRUENWALD

FF810R-FF811R



MILLIMETERS

Knochenstanzen, Rongeurs – Bone Punches, Rongeurs

Rongeurs

Rongeurs

FF



170 mm, 6 3/4"

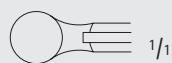

Ø 7,0 mm
diam. 7.0 mm



OLDBERG

FF605R

185 mm, 7 1/4"



FF599R

Ø 2,2 mm
diam. 2.2 mm

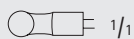

FF600R

Ø 3,5 mm
diam. 3.5 mm

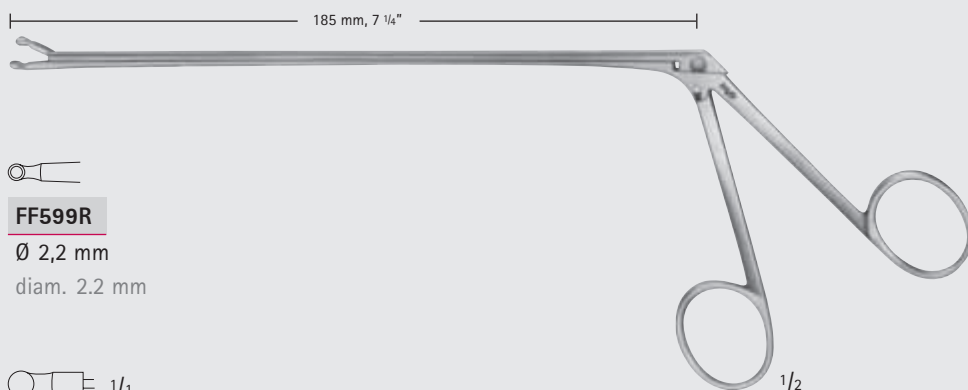

YASARGIL

FF599R-FF600R



Knochenstanzen, Rongeurs – Bone Punches, Rongeurs

Rongeurs
Rongeurs

FF

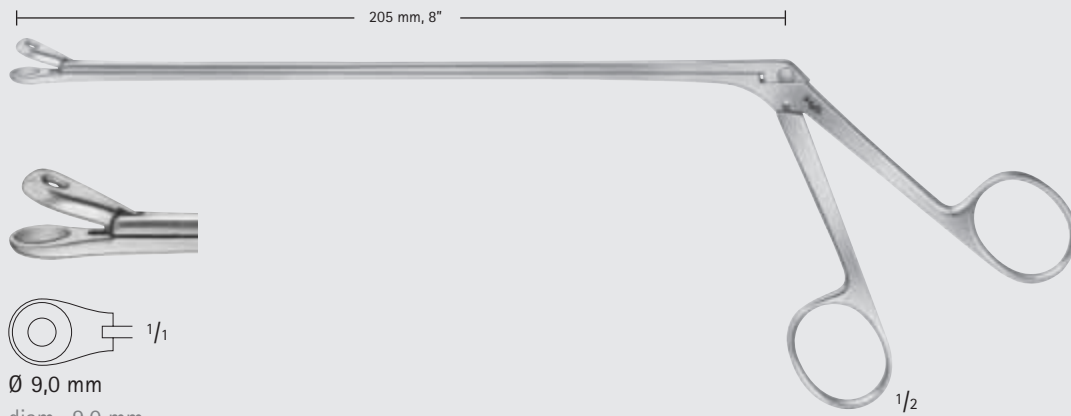

Ø 9,0 mm
diam. 9.0 mm

LANDOLT

FF345R

Tumorfasszange, stumpf
Tumor grasping forceps, blunt

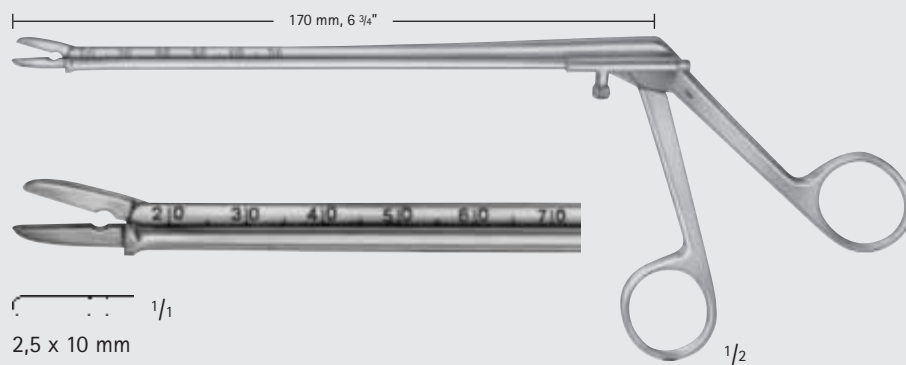

2,5 x 10 mm

KRÄMER

FF820R

mit Tiefenanschlag
with depth guard



MILLIMETERS

Knochenstanzen, Rongeurs – Bone Punches, Rongeurs

Rongeurs

Rongeurs

FF

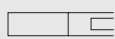
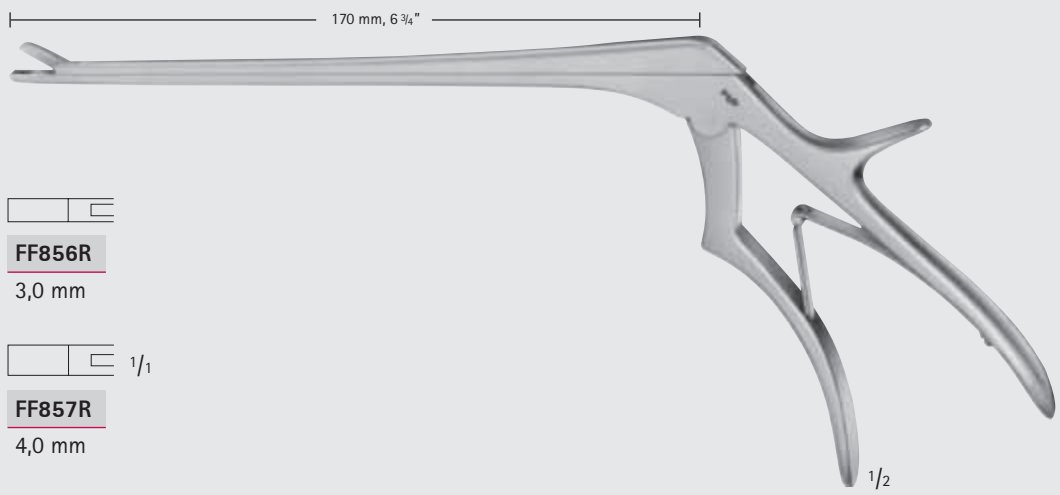

FF856R

3,0 mm



FF857R

4,0 mm

CASPAR

FF856R-FF857R

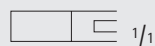
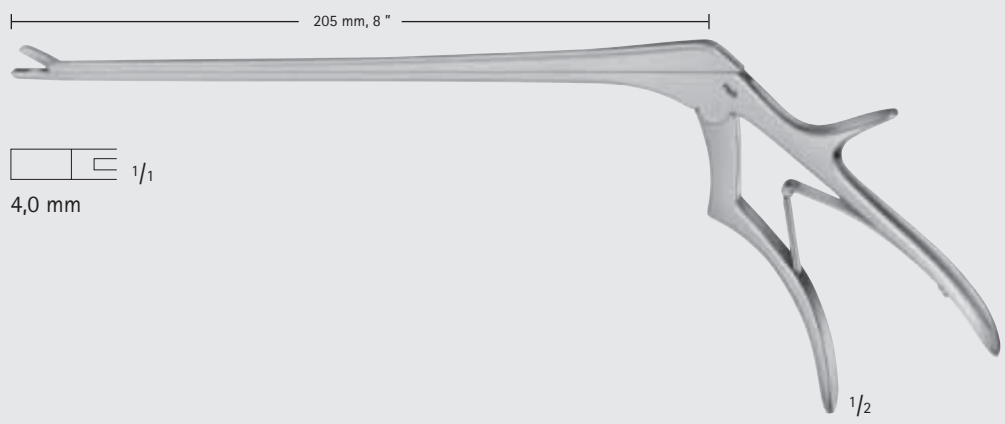

4,0 mm

CASPAR

FF858R



Knochenstanzen, Rongeurs – Bone Punches, Rongeurs

Rongeurs
Rongeurs

FF

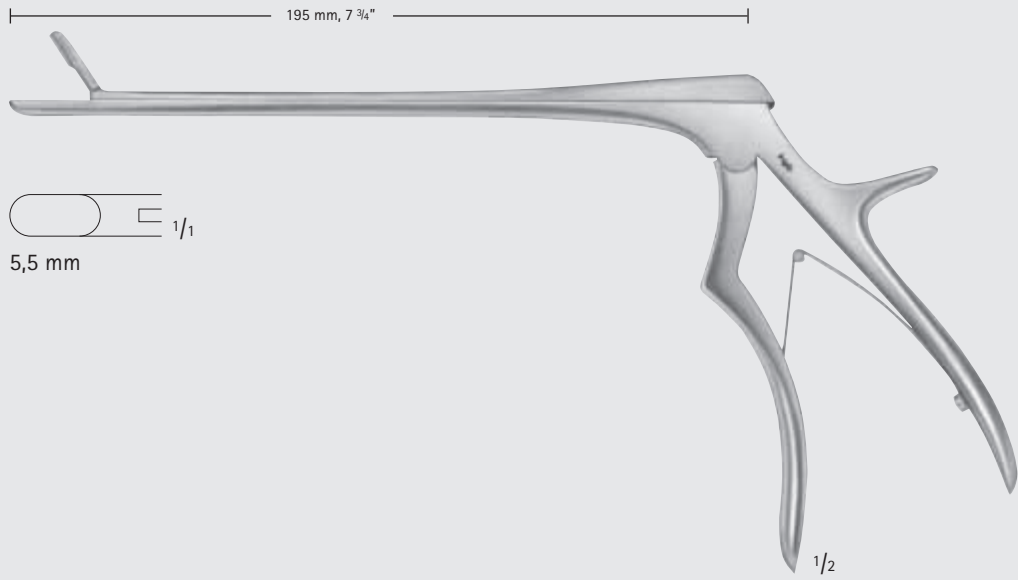

WAGNER

FF818R

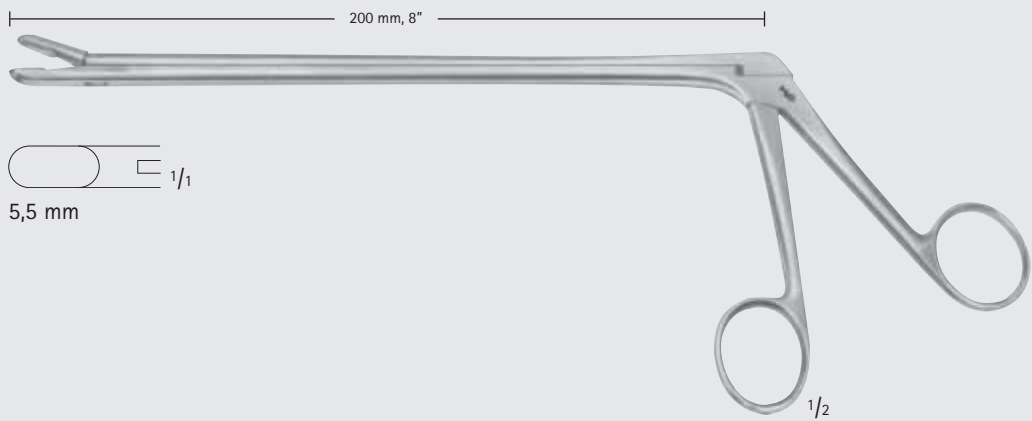

WAGNER

FF808R



MILLIMETERS

Knochenstanzen, Rongeur – Bone Punches, Rongeurs

Rongeur

Rongeurs

FF

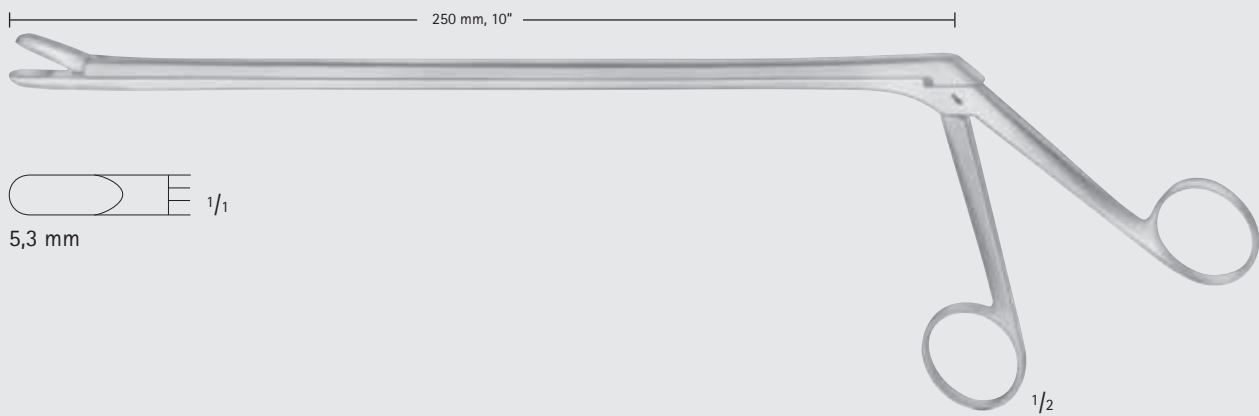

ND087R

150°

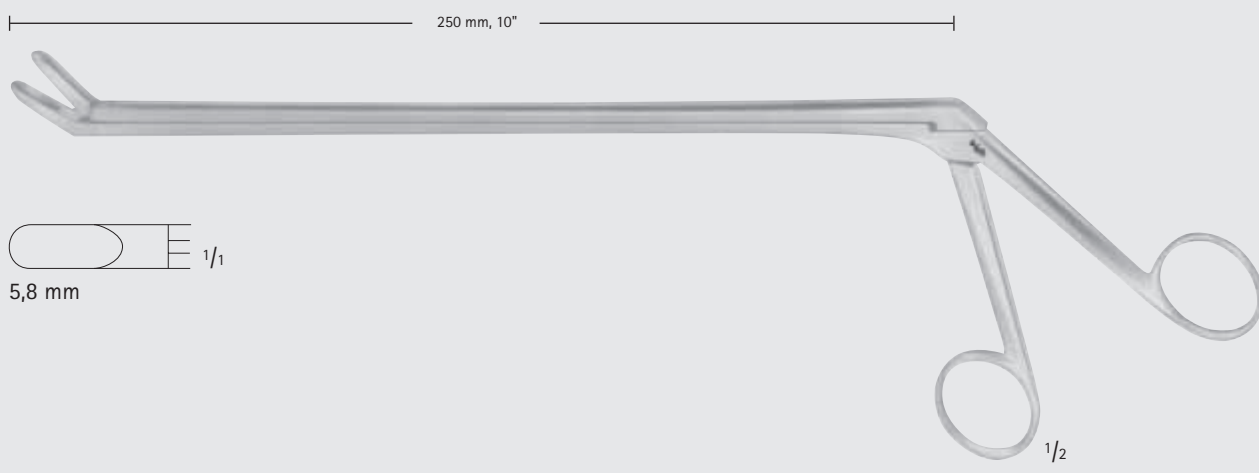

SYPERT

FG057R



Knochenstanzen, Rongeurs – Bone Punches, Rongeurs

Ligamentum Flavum Faszange

Grasping Forceps for Ligamentum Flavum

FF

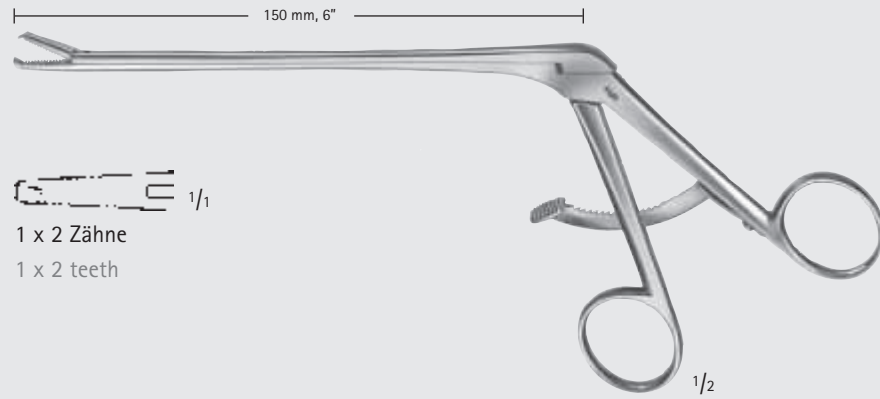

1/1
1 x 2 Zähne
1 x 2 teeth

KRAMER

FO820R

mit Sperre
with catch

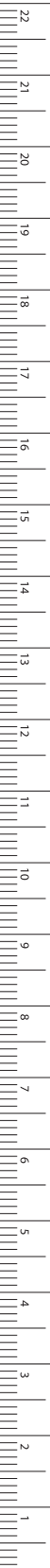

MILLIMETERS



INCHES



FH



Amputation
Amputation

Amputation – Amputation

Amputation

Amputation

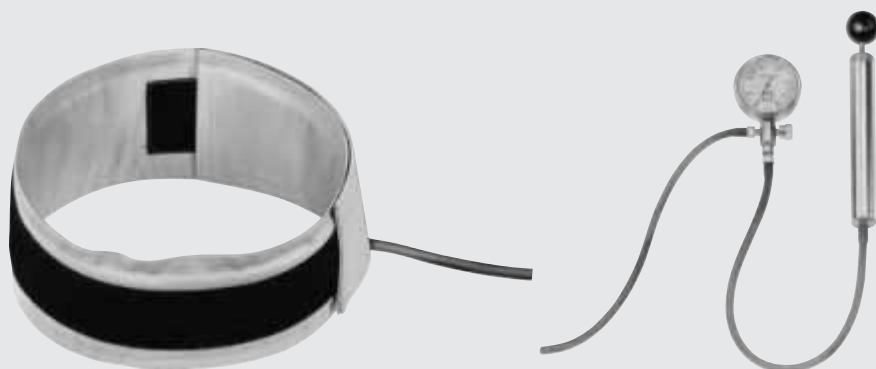

FH001

Komprimierer zur Erzeugung einer Blutleere in den Extremitäten. Manometer mit Messbereich bis 600 mm Hg.

Komplett, bestehend aus:

FH002 Luftpumpe mit Manometer

FH003 Oberschenkel-Manschette, 13,5 cm x 120 cm

FH014 Oberarm-Manschette, 10 cm x 84 cm

Compression apparatus for producing exsanguination in the extremities.

Manometer registers up to 600 mm Hg.

Complete, consisting of:

FH002 Pump with manometer

FH003 Cuff for the leg, 3,5 cm x 120 cm

FH014 Cuff for the upper arm, 10 cm x 84 cm



FH003 Oberschenkel-Manschette, 13,5 cm x 120 cm

Cuff for the leg, 13,5 cm x 120 cm

***FH004** Unterarm-Manschette, 9,5 x 50 cm

Cuff for the lower arm, 9,5 x 50 cm

***FH005** Kinder-Manschette, 7,3 x 36 cm

Cuff for children, 7,3 x 36 cm

FH014 Oberarm-Manschette, 10 cm x 84 cm

Cuff for the upper arm, 10 cm x 84 cm

* zusätzlich zu bestellen zu FH001

* to be ordered separately for FH001



ESMARCH

FH010

Staubbinde

5 m lang

6 cm breit

Compression bandage

5 m long

6 cm wide



Amputation – Amputation
 Amputationsmesser
 Amputation Knives

FH



doppelschneidig
 double cutting

LISTON

FH100R-FH103R

Amputationsmesser
 Amputation knives

	FH100R	FH101R	FH102R	FH103R
Schnittlänge:	130 mm	160 mm	190 mm	220 mm
Blade length:	5 1/8"	6 1/4"	7 1/2"	8 3/4"

Schnittlänge:

Blade length:



doppelschneidig
 double cutting

CATLIN

FH116R

Amputationsmesser
 Amputation knife

Schnittlänge: 160 mm

Blade length: 6 1/4"



LANGENBECK

FH150R

Lappenmesser
 Flap knife

Schnittlänge: 120 mm

Blade length: 6 1/4"

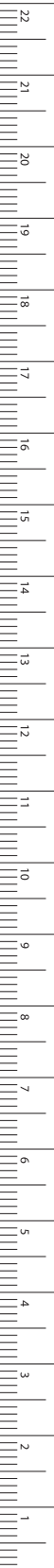

MILLIMETERS

Amputation – Amputation
 Amputations- und Resektionsmesser
 Amputation- and Resection Knives

FH



1/2

FH160R

Phalangenmesser
 Phalangeal knife

Schnittlänge: 105 mm
 Blade length: 4 1/8"



1/2

FH166R

Zwischenknochenmesser
 Interosseous knife

Schnittlänge: 110 mm
 Blade length: 4 3/8"

doppelschneidig
 double cutting



1/2

FH170R

Beinhautmesser
 mit Schaber
 Periosteum knife
 with raspatory

Schnittlänge: 65 mm
 Blade length: 2 1/2"



1/2

FH191R

FH192R

1/1

LANGENBECK

FH191R-FH192R

Resektionsmesser
 Resection knives

Schnittlänge: 55 mm
 Blade length: 2 1/8"



Amputation – Amputation

Sterilisierahmen für Resektions- und Amputationsmesser
Sterilizing Racks for Resection- and Amputation Knives

FH

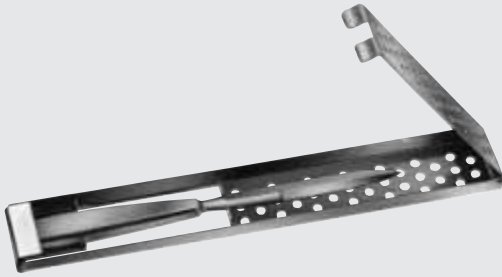

FH194R

Sterilisierahmen für 1 Messer
mit Schnittlänge bis 140 mm
Sterilizing rack for 1 knife
with length of blade up to 140 mm
290 x 40 x 14 mm

FH194R-FH197R

für Resektions- und Amputationsmesser
for Resection- and Amputation knives

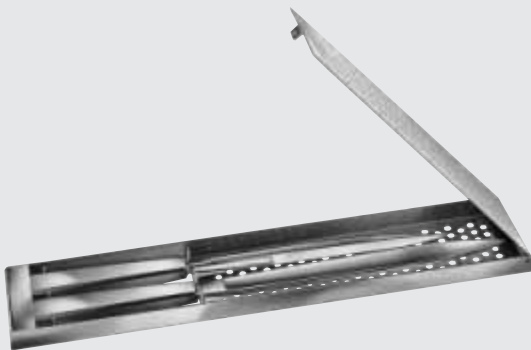

FH197R

Sterilisierahmen für 2 Messer
mit Schnittlängen bis 190 mm
Sterilizing rack for 2 knives
with length of blade up to 190 mm
335 x 65 x 14 mm

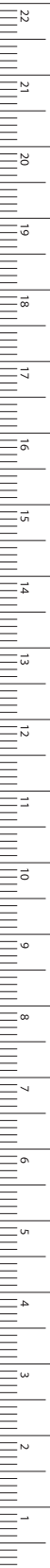

MILLIMETERS

Amputation – Amputation

Amputationsretractoren

Amputation Retractors

FH

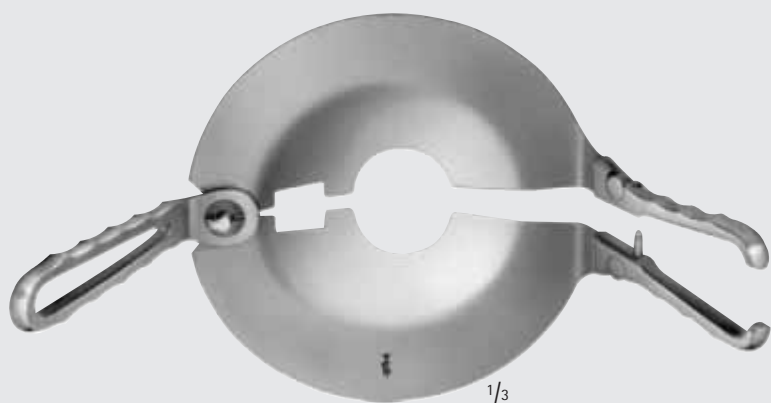

PERCY

FH220R

Griffe abnehmbar
removable handles

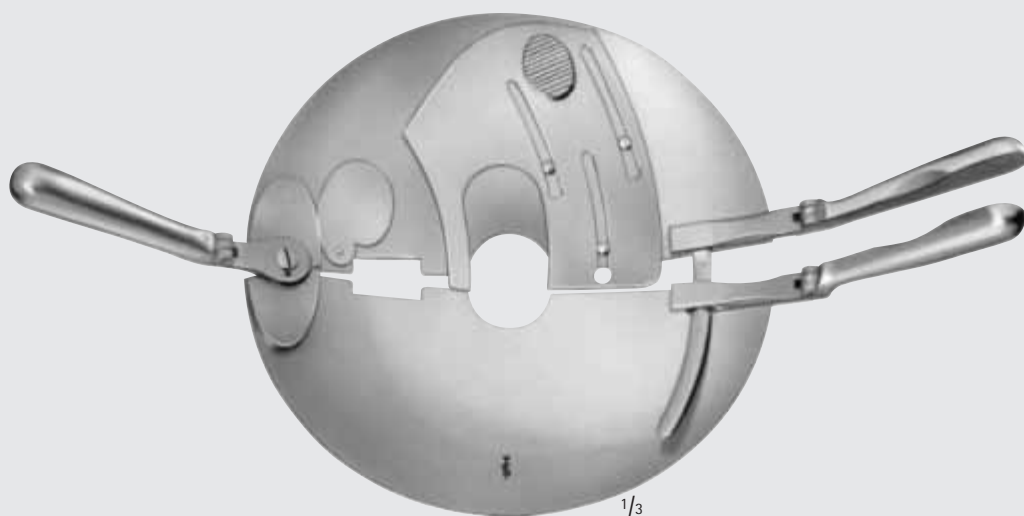

PERCY

FH222R

Griffe umlegbar
reversible handles



Amputation – Amputation Amputationssägen Amputation Saws

FH



1/3

CHARRIÈRE

FH300R

komplett mit je 1 Sägeblatt
complete with one saw blade each

FH301C 12 mm

FH302C 18 mm

350 mm, 14"

FH301C-FH302C

Ersatz-Sägeblätter, Normalstahl verchromt
Spare saw blades, carbon steel chromium plated

	Breite Width	Blattlänge Blade length
FH301C	12 mm	215 mm, 8 1/2"
FH302C	18 mm	215 mm, 8 1/2"

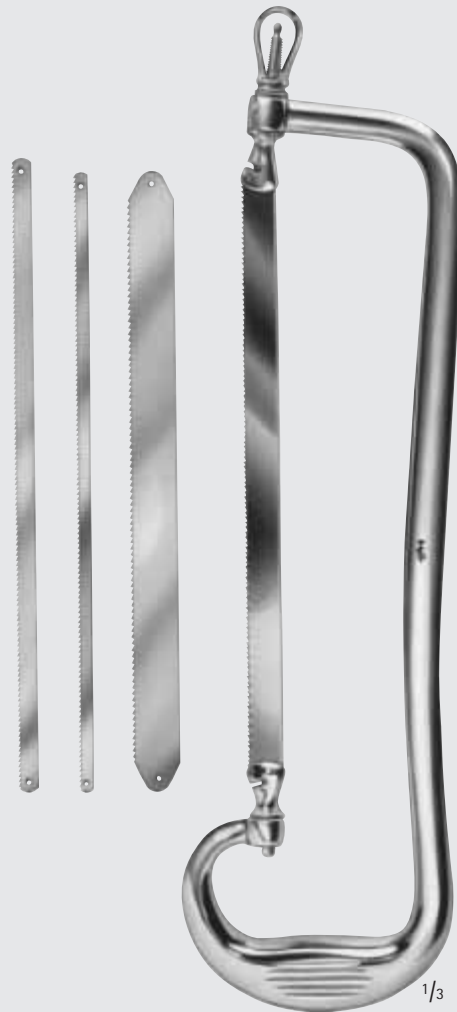

1/3

RUST

FH305R

komplett mit Sägeblättern
complete with saw blades

1 FH307C 6 mm

1 FH308C 8 mm

2 FH310C 12 mm

390 mm, 15 1/2"

FH306R

Bogen allein
Bow only

FH307C-FH312C

Ersatz-Sägeblätter, Normalstahl verchromt
Spare saw blades, carbon steel chromium plated

	Breite Width	Blattlänge Blade length
FH307C	6 mm	235 mm, 9 1/4"
FH308C	8 mm	235 mm, 9 1/4"
FH310C	12 mm	235 mm, 9 1/4"
FH312C	18 mm	235 mm, 9 1/4"

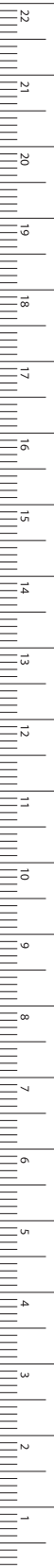

MILLIMETERS

Amputation – Amputation

Amputationssägen

Amputation Saws

FH

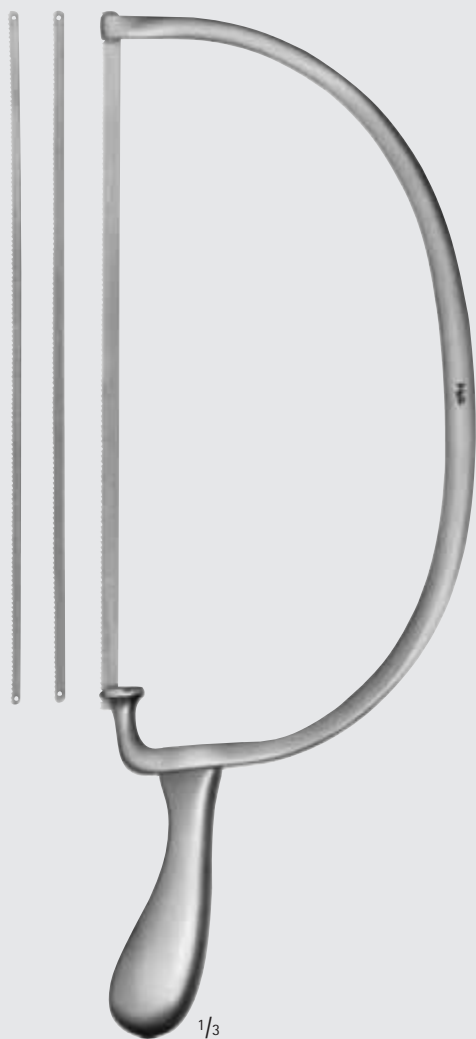

1/3

BIER

FH313R

komplett mit je 1 Sägeblatt

complete with one saw blade each

FH314C 4 mm

FH315C 6 mm

FH316C 8 mm

420 mm, 16 3/4"

FH314C-FH316C

Ersatz-Sägeblätter, Normalstahl verchromt

Spare saw blades, carbon steel chromium plated

	Breite Width	Blatlänge Blade length
FH314C	4 mm	270 mm, 10 1/2"
FH315C	6 mm	270 mm, 10 1/2"
FH316C	8 mm	270 mm, 10 1/2"



1/2

CHARRIÈRE

FH320R

270 mm, 10 1/2"

Blatlänge: 184 mm,

Blade length: 7 1/4"



SATTERLEE

FH325R

290 mm, 11 1/2"

Blattlänge

Blade length

FH326R 200 mm, 8"

Ersatz-Sägeblatt

Spare saw blade



LANGENBECK

FH335R

Finger-Stichsäge

Metacarpal saw

235 mm, 9 1/4"

Blattlänge: 115 mm,

Blade length: 4 1/2"

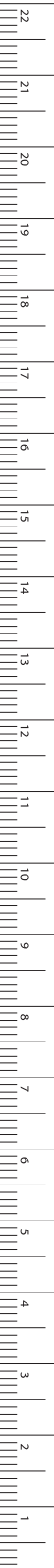

Amputation – Amputation

Drahtsägen

Wire Saws

FH

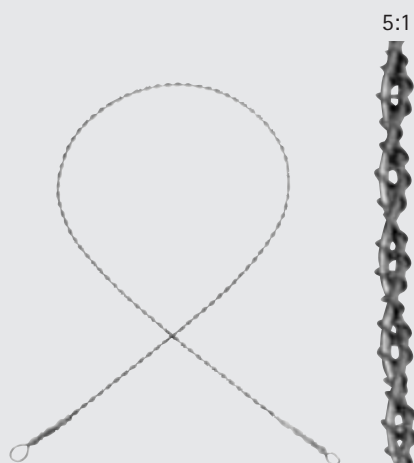

OLIVECRONA

Ø
Diam.

FH403	1,5 mm	300 mm, 12"
FH404	1,3 mm	400 mm, 16"
FH405	1,2 mm	500 mm, 20"
FH407	1,2 mm	700 mm, 28"

Bestelleinheit:

PAK = Packung à 5 Stück

Sales unit:

PAK = Package of 5 pieces

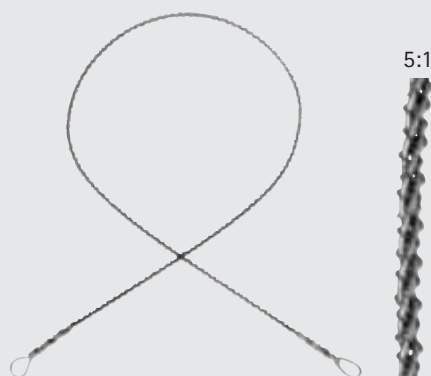

GIGLI

Ø
Diam.

FH413	1,4 mm	300 mm, 12"
FH414	1,4 mm	400 mm, 16"
FH415	1,4 mm	500 mm, 20"

fein, 6-teilig

fine, 6 wires twisted

FH430R

grob, 4-teilig

coarse, 4 wires twisted

500 mm, 20"

Bestelleinheit:

PAK = Packung à 5 Stück

Sales unit:

PAK = Package of 5 pieces



GIGLI

FH480R

Griff

Handle



1/2

LEBSCHÉ

FF133C

Umführungsinstrument für GIGLI und OLIVECRONA Drahtsägen, biegsam
 Conductor for GIGLI and OLIVECRONA wire saws, malleable
 250 mm, 10"



1/2

DE MARTEL

FF130R

Umführungsinstrument für GIGLI und OLIVECRONA Drahtsägen, flexibel
 Conductor for GIGLI and OLIVECRONA wire saws, flexible
 350 mm, 14"

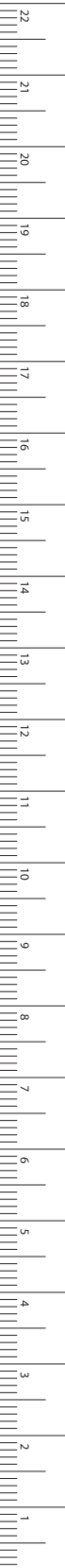

MILLIMETERS

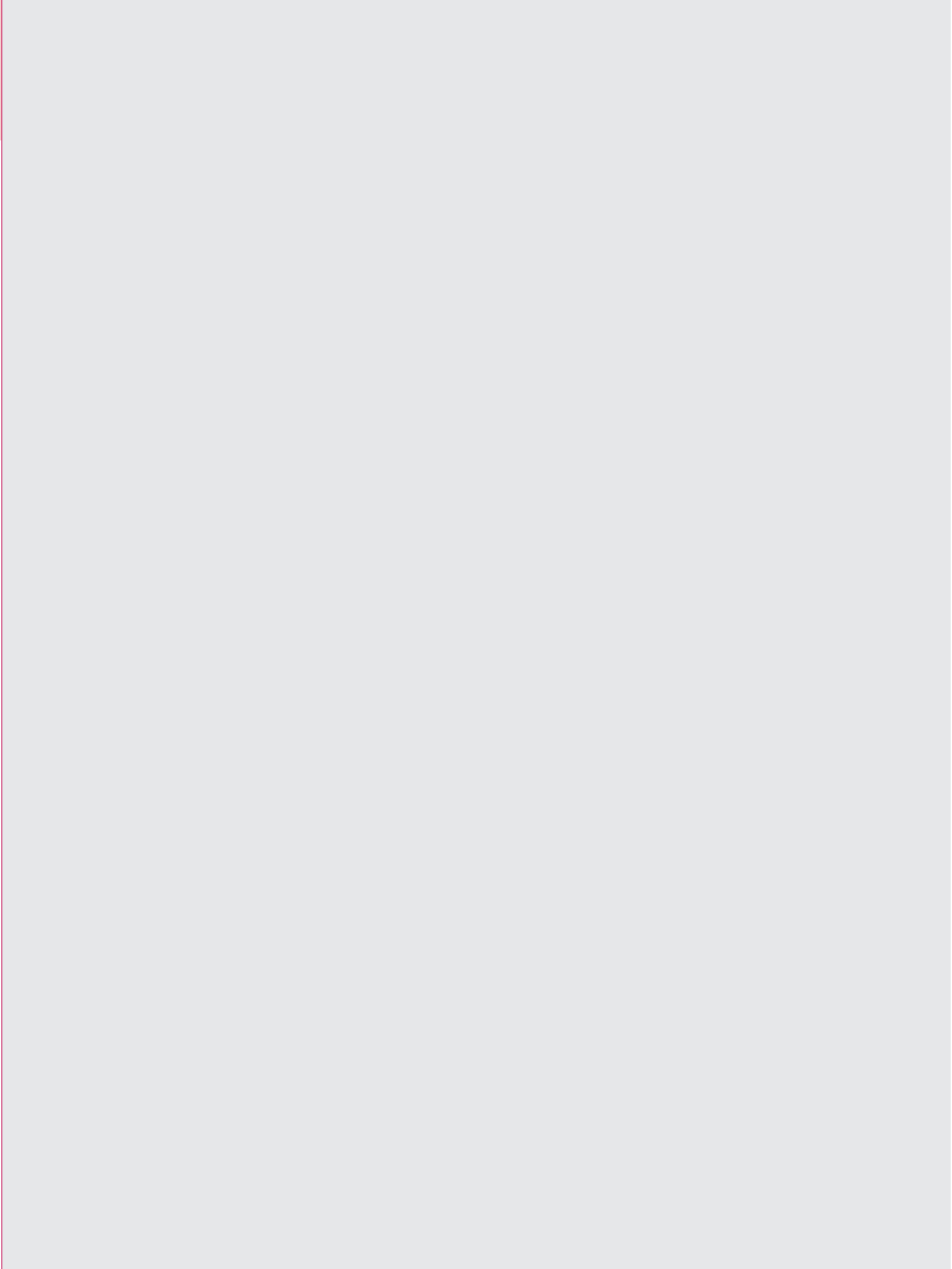

FK



**Knochenhebel, Elevatorien,
Raspatorien, Scharfe Löffel**
Bone Levers, Periosteal Elevators,
Bone Curettes

Knochenheber, Raspatorien, Scharfe Löffel – Bone Levers, Elevators, Bone Curettes

Dissektoren

Dissectors

FK

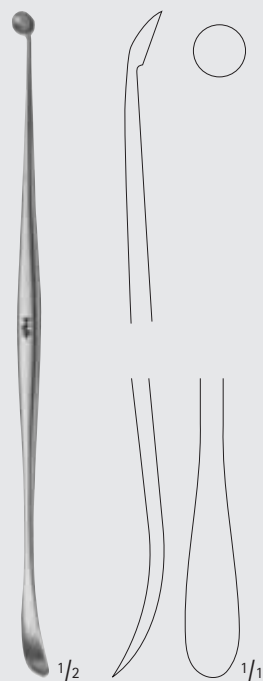

PENFIELD

FF291R

Fig. 1
doppelendig
double-ended
175 mm, 7"

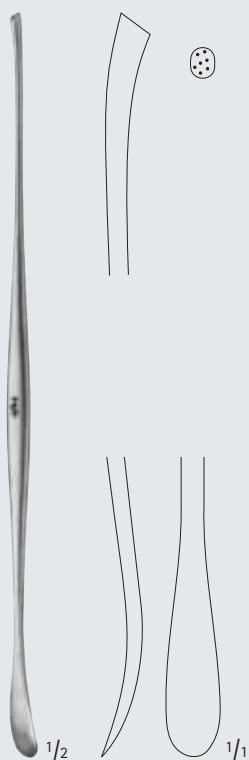

PENFIELD

FF292R

Fig. 2
doppelendig
double-ended
195 mm, 7 3/4"

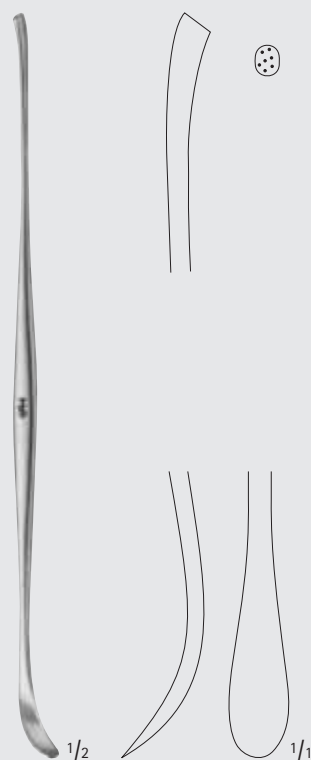

PENFIELD

FF293R

Fig. 3
doppelendig
double-ended
195 mm, 7 3/4"



PENFIELD

FF294R

Fig. 4
leicht gebogen
slightly curved
205 mm, 8"

Knochenheber, Raspatorien, Scharfe Löffel – Bone Levers, Elevators, Bone Curettes

Dissektoren, Hohlsonden
Dissector, Grooved Director

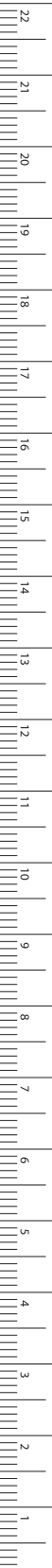
SWEDISH
FF347R 180 mm, 7"

 leichtes Modell
light pattern

FF348R 200 mm, 8"

 kräftiges Modell
heavy pattern

PENNYBACKER
FF349R

 Sonde und Dissektor
Probe dissector
230 mm, 9"

O'CONNELL
FF730R

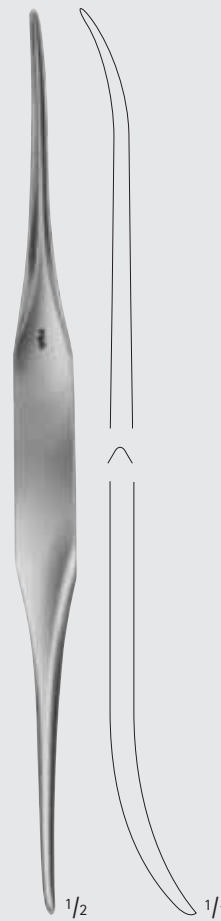
 doppelendig
double-ended
220 mm, 8 3/4"

TÖNNIS
FF308R

 Hohlsonde
Grooved director
240 mm, 9 1/2"

PENFIELD
FF295R

 Fig. 5
doppelendig, leicht gebogen
double-ended, slightly curved
290 mm, 11 1/2"

Knochenheber, Raspatorien, Scharfe Löffel – Bone Levers, Elevators, Bone Curettes

Elevatoren und Knochenheber

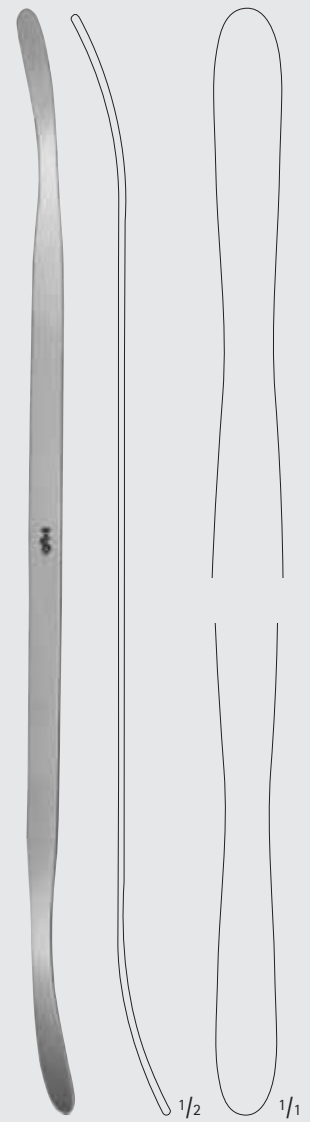
Elevators and Bone Levers

FK

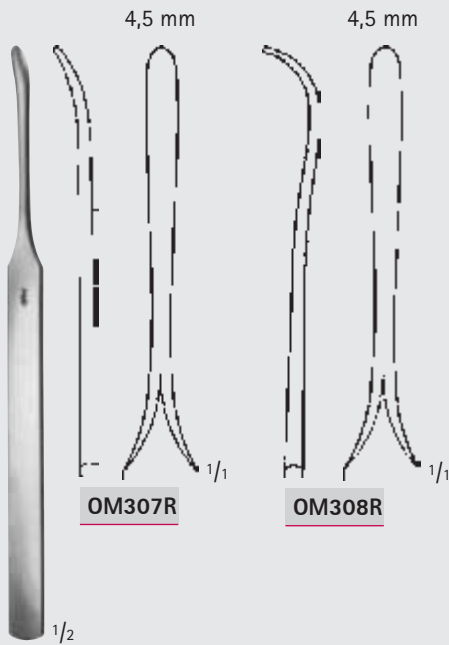

OM307R

OM308R

KÖNIG

OM307R-OM308R

155 mm, 6"

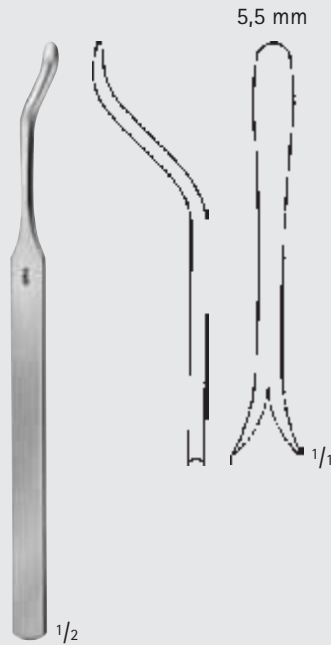

FK110R

155 mm, 6"



CAIRNS

FK141R

175 mm, 6 3/4"

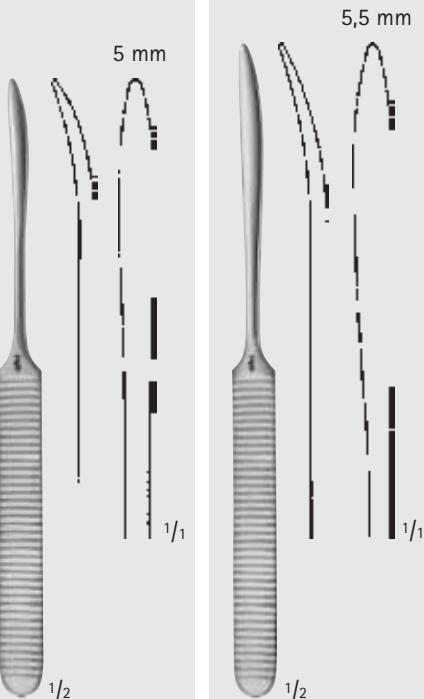

WILLIGER

FK120R

165 mm, 6 1/2"

WILLIGER

FK121R

170 mm, 6 3/4"



MB275R

klein

small

14 mm

185 mm

7 1/4"

MB276R

mittel

medium

19 mm

205 mm

8"

MB277R

groß

large

25 mm

235 mm

9 1/4"

MB278R

extra groß

extra large

30 mm

255 mm

10"

CHANDLER

MB275R-MB278R



Knochenheber, Raspatorien, Scharfe Löffel – Bone Levers, Elevators, Bone Currettes

Elevatorien und Knochenheber

Elevators and Bone Levers

FK

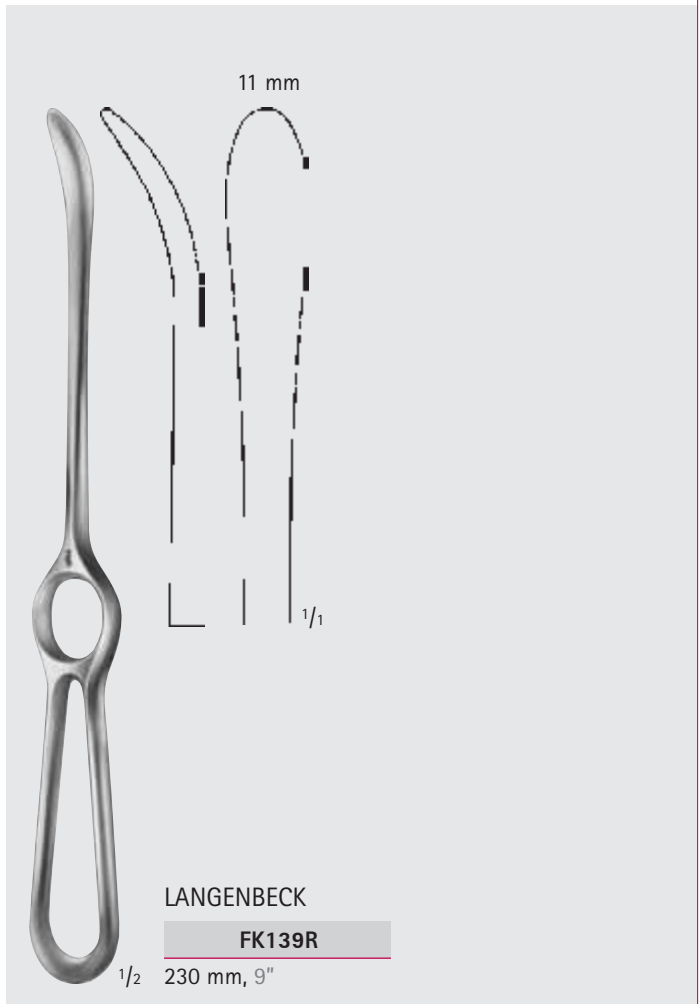
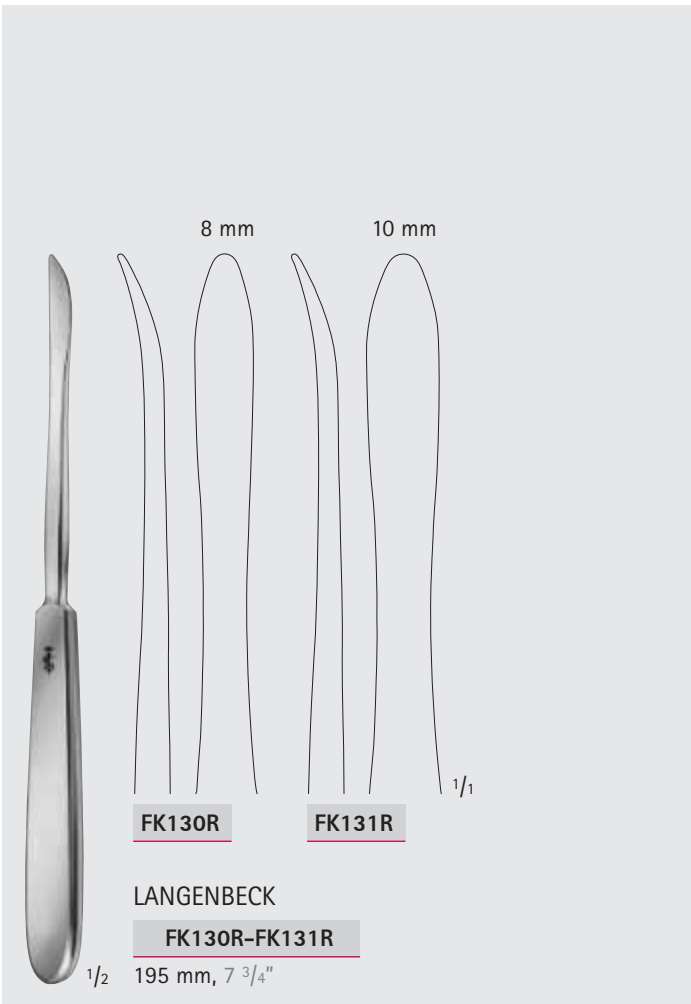
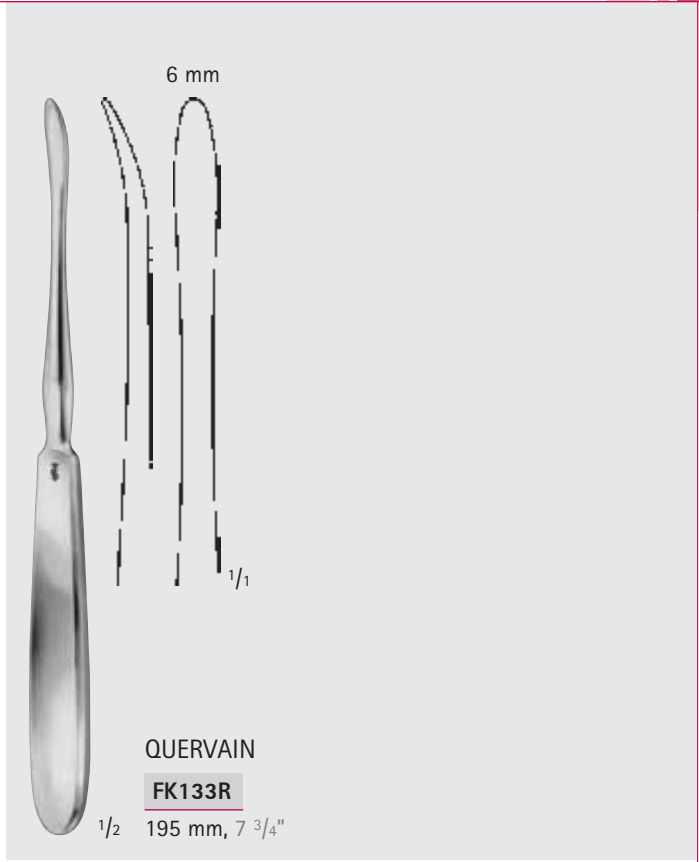
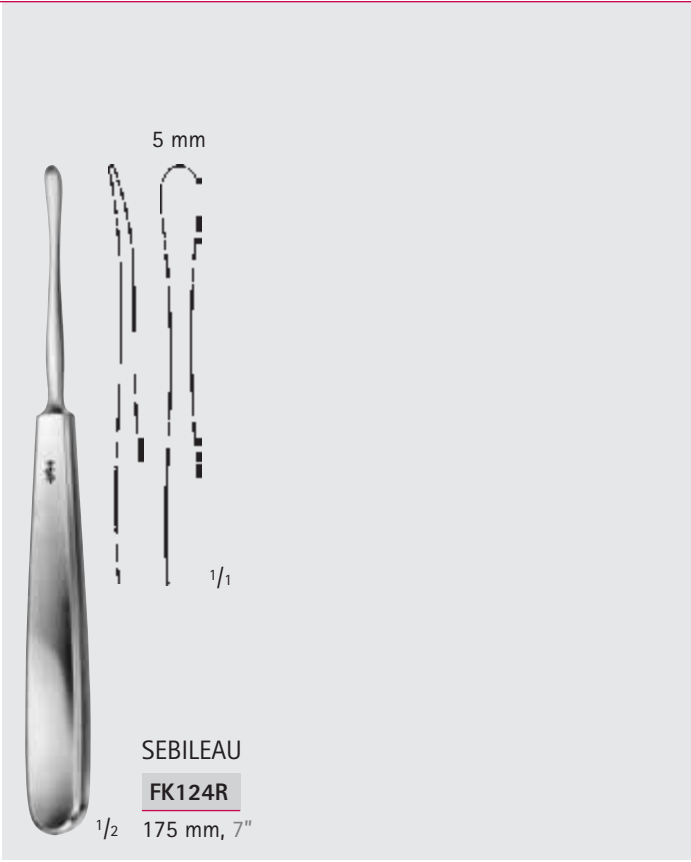

MILLIMETERS

Knochenheber, Raspatorien, Scharfe Löffel – Bone Levers, Elevators, Bone Curettes

Knochenheber

Bone Levers

FK



FK111R

140 mm, 5 1/2"

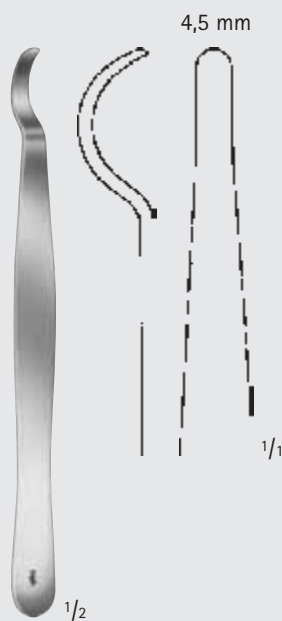

FK113R

150 mm, 6"

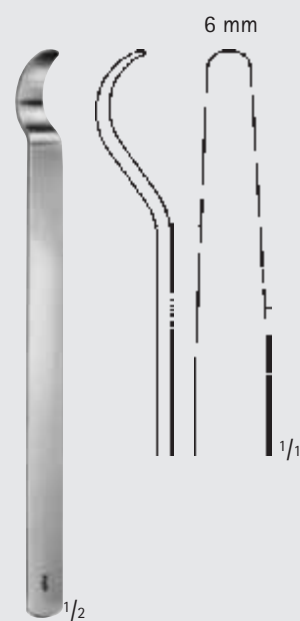

FK114R

150 mm, 6"

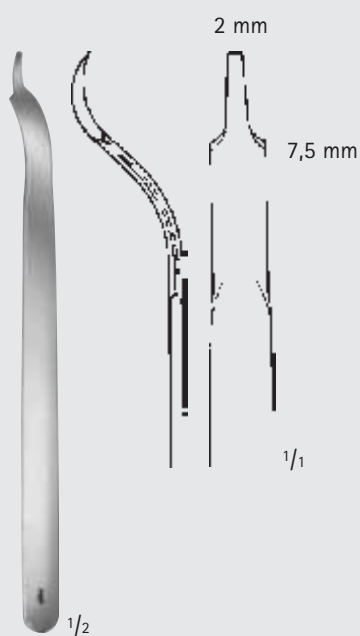

BUCK-GRAMCKO

FK116R

150 mm, 6"



FK117R

160 mm, 6 1/4"

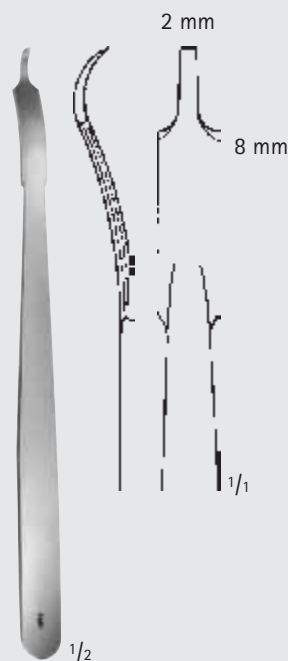

FK118R

160 mm, 6 1/4"

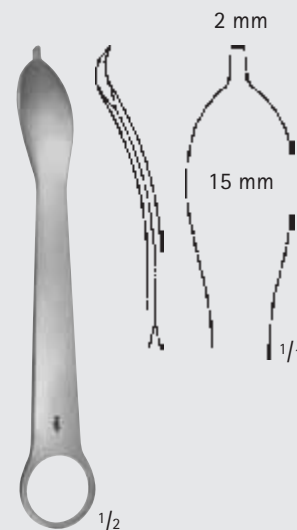

FK119R

125 mm, 5"



Knochenheber, Raspatorien, Scharfe Löffel – Bone Levers, Elevators, Bone Curettes

Knochenheber
Bone Levers

FK



LANE TRETHOWAN

FK135R

215 mm, 8 1/2"

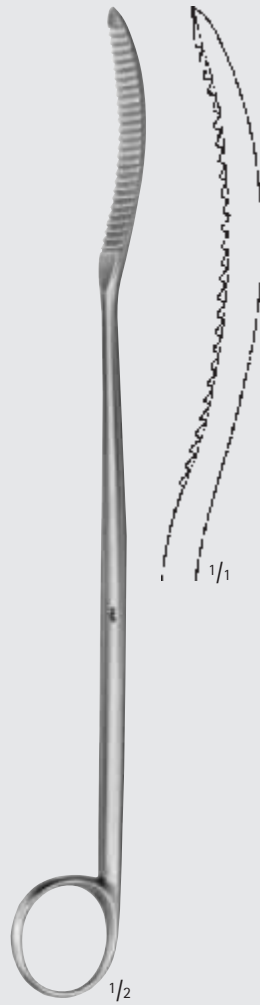

LANE

FK136R

255 mm, 10"

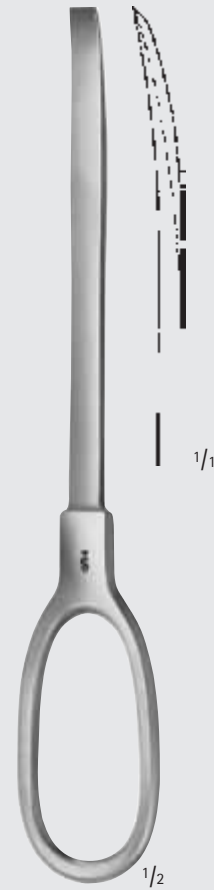

BRISTOW

FK140R

230 mm, 9"



MILLIMETERS

Knochenheber, Raspatorien, Scharfe Löffel – Bone Levers, Elevators, Bone Curettes

Knochenheber

Bone Levers

FK



WATSON-JONES

FK156R

280 mm, 11"

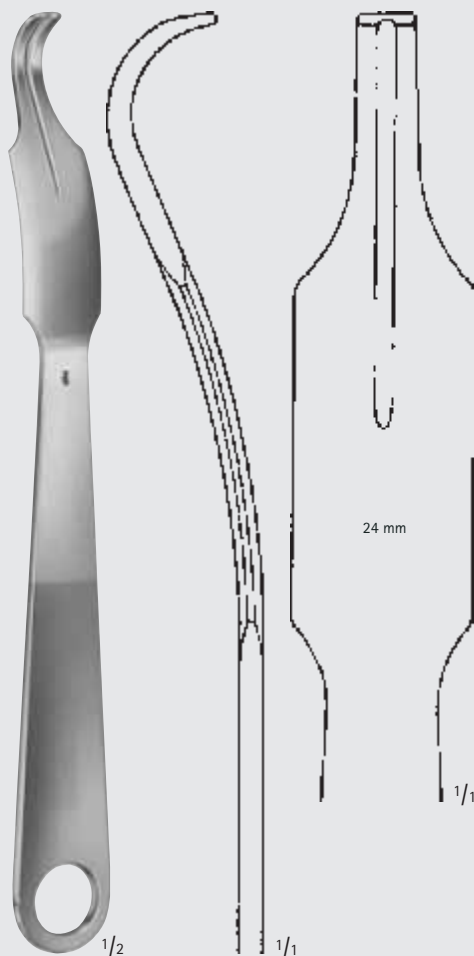

LANGE-HOHMANN

FK160R

250 mm, 10"



Knochenheber, Raspatorien, Scharfe Löffel – Bone Levers, Elevators, Bone Curettes

Knochenheber
Bone Levers

FK

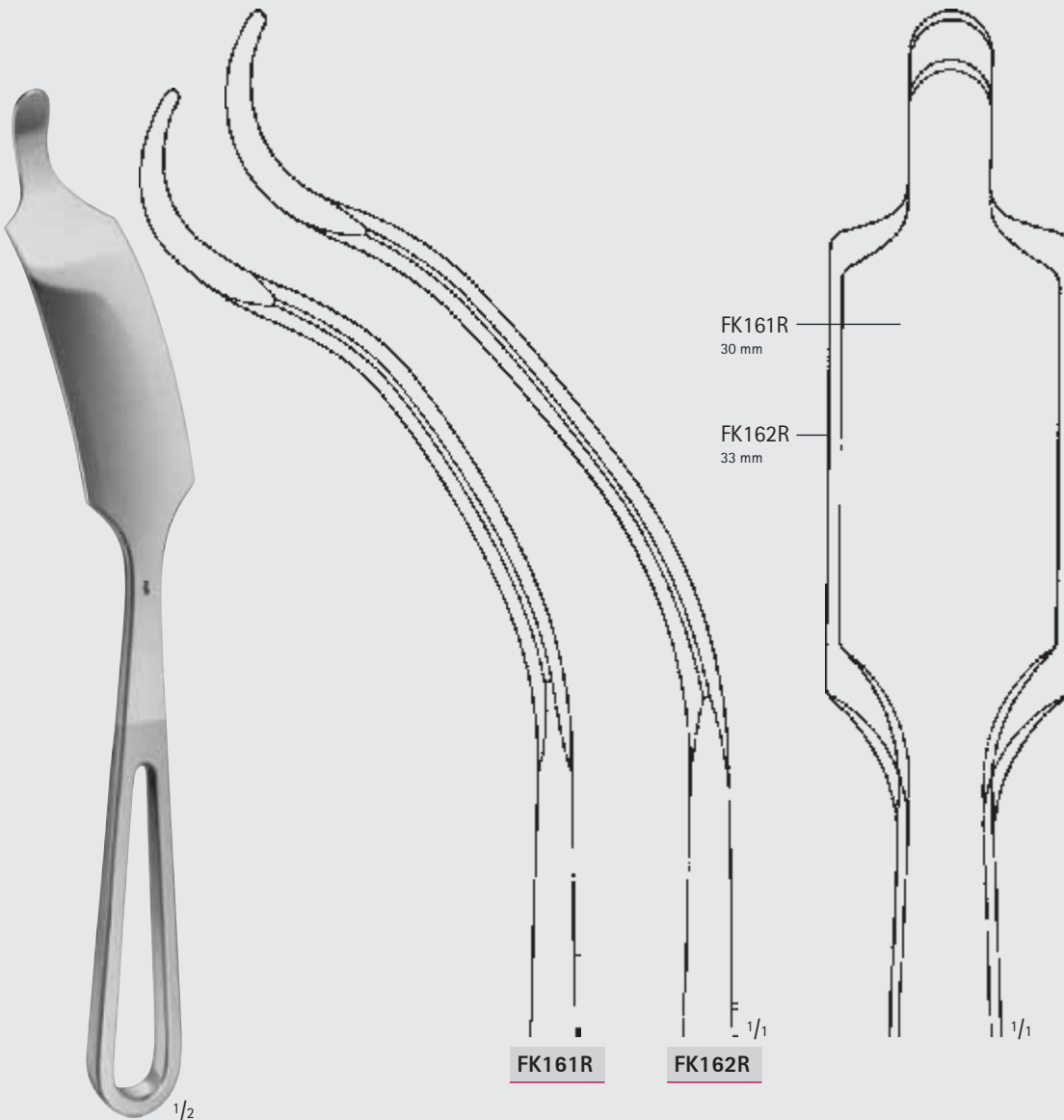

LANGE-HOHMANN MODIF.

FK161R	265 mm	10 1/2"
FK162R	280 mm	11 1/2"

MILLIMETERS

Knochenheber, Raspatorien, Scharfe Löffel – Bone Levers, Elevators, Bone Curettes

Knochenheber

Bone Levers

FK

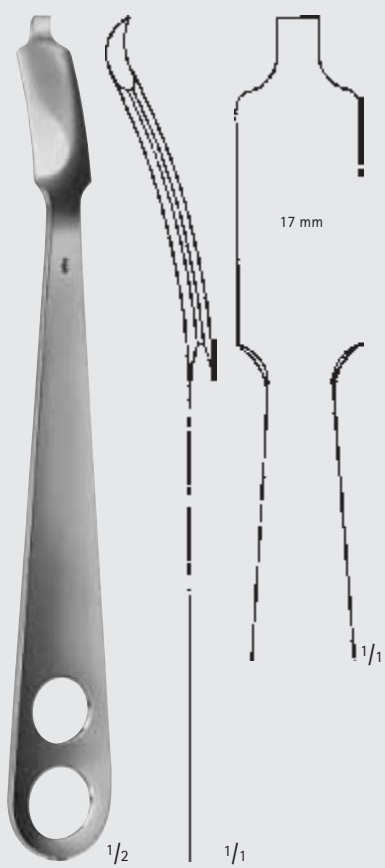

WAGNER

FK167R

220 mm, 8 3/4"

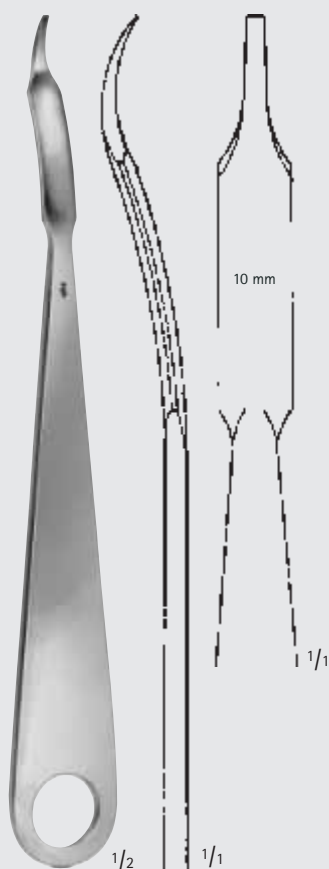

FK170R

220 mm, 8 3/4"

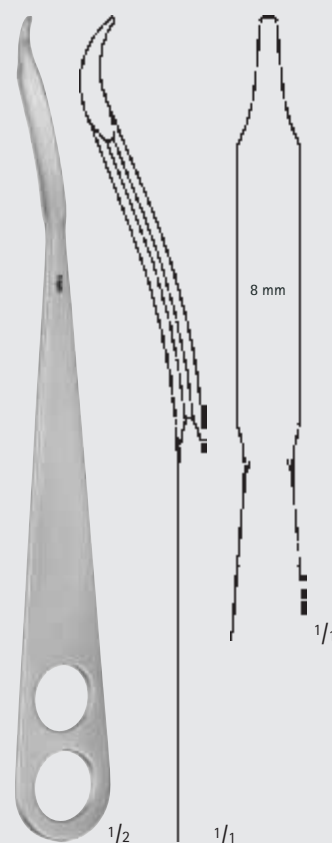

FK185R

220 mm, 8 3/4"



Knochenheber, Raspatorien, Scharfe Löffel – Bone Levers, Elevators, Bone Curettes

Knochenheber
Bone Levers

FK

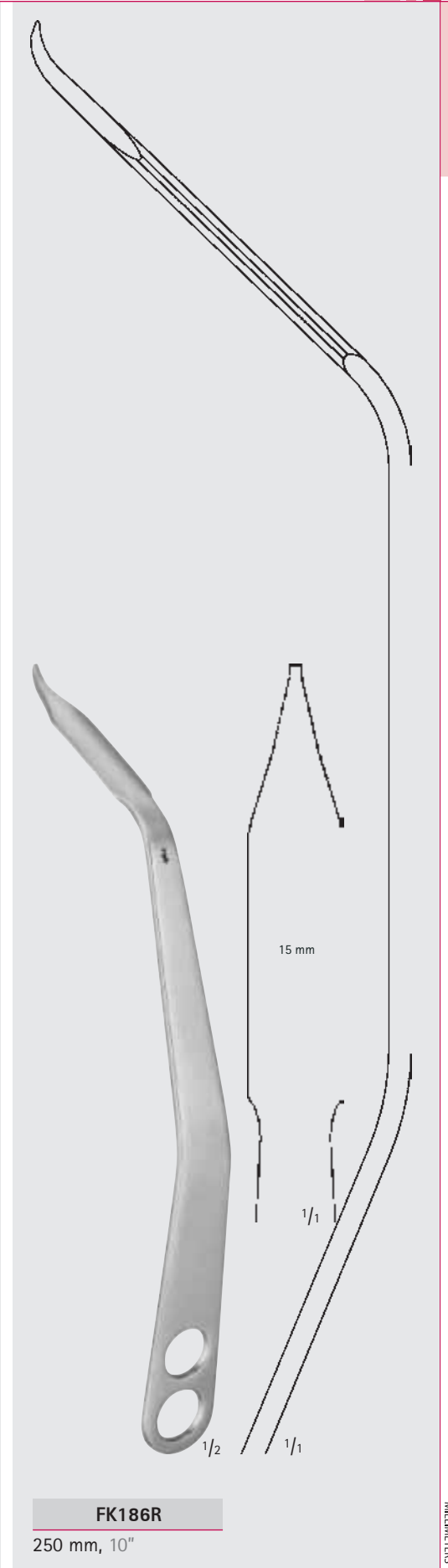
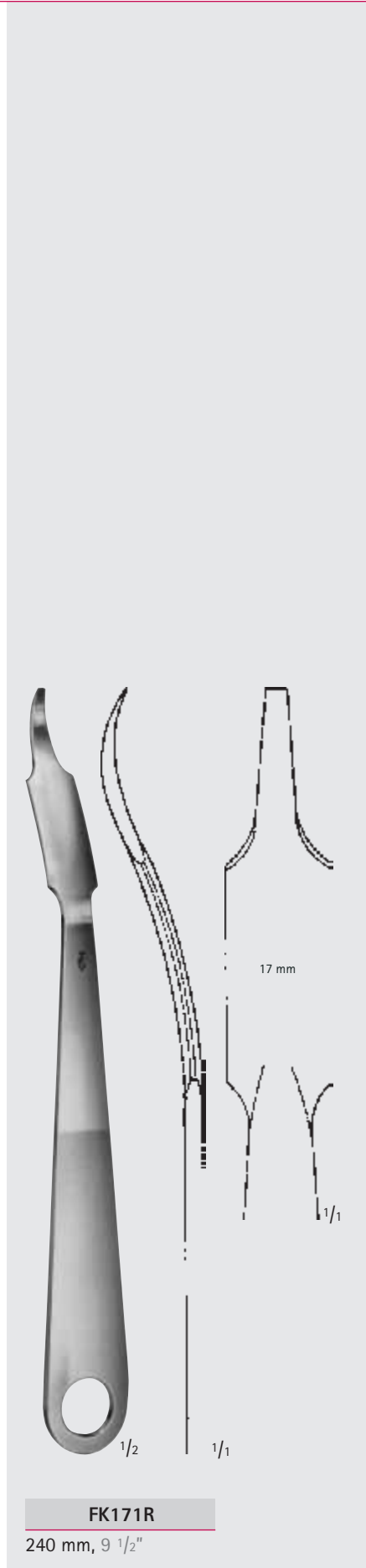
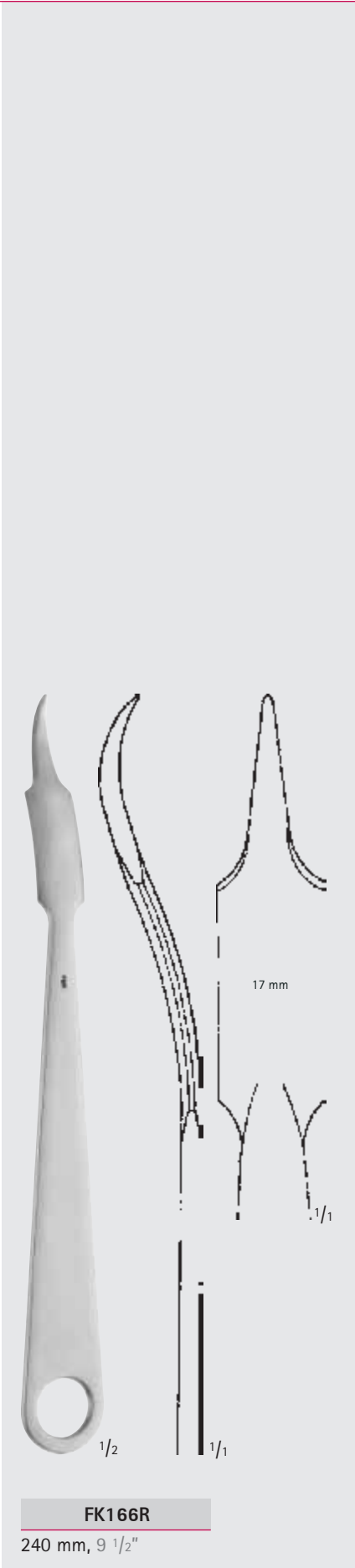

Knochenheber, Raspatorien, Scharfe Löffel – Bone Levers, Elevators, Bone Curettes

Knochenheber

Bone Levers

FK

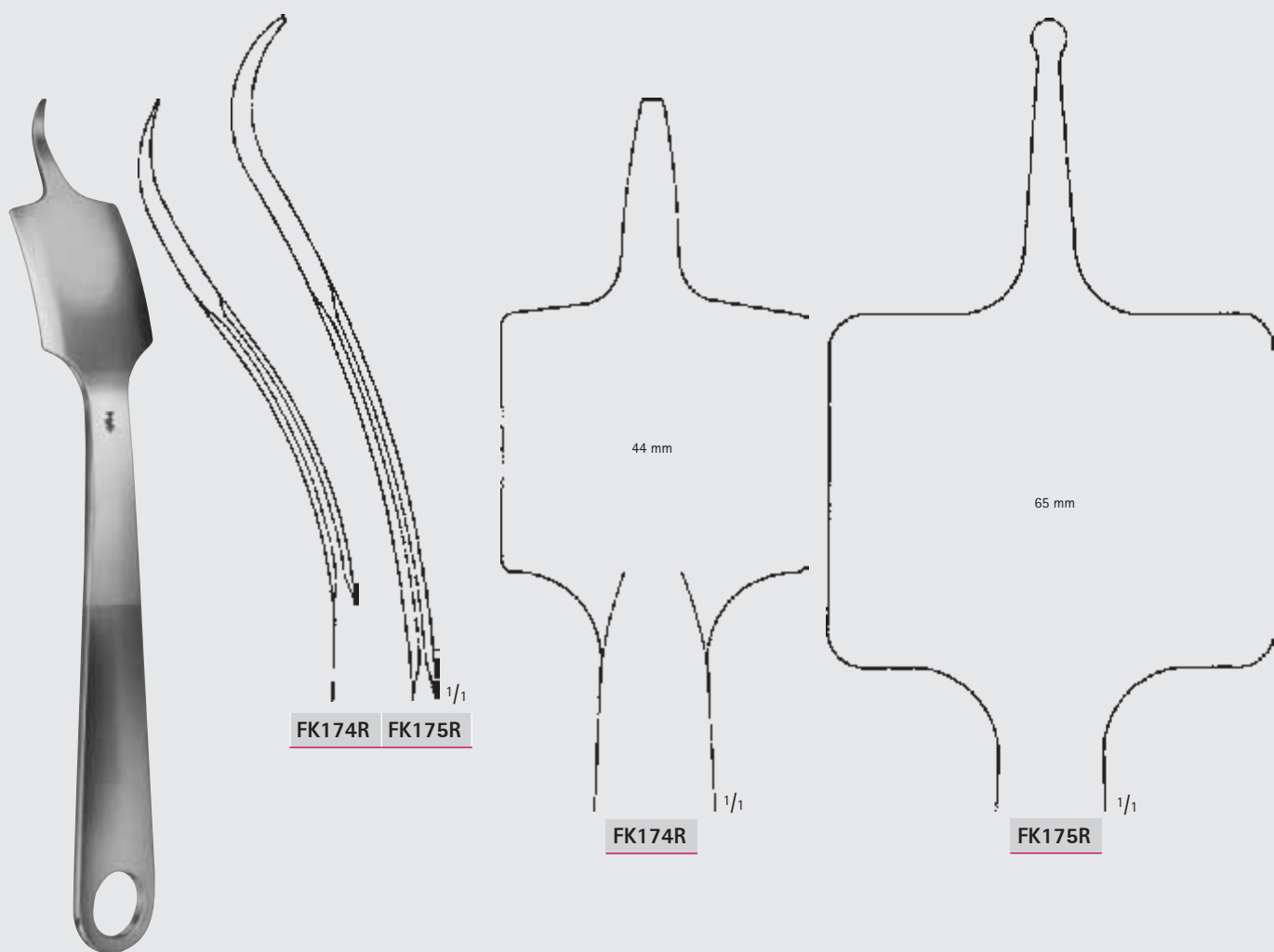

FK174R FK175R

FK174R

FK175R

VERBRUGGE-MÜLLER

FK174R	240 mm	9 1/2"
FK175R	255 mm	10"



Knochenheber, Raspatorien, Scharfe Löffel – Bone Levers, Elevators, Bone Curettes

Knochenheber
Bone Levers

FK

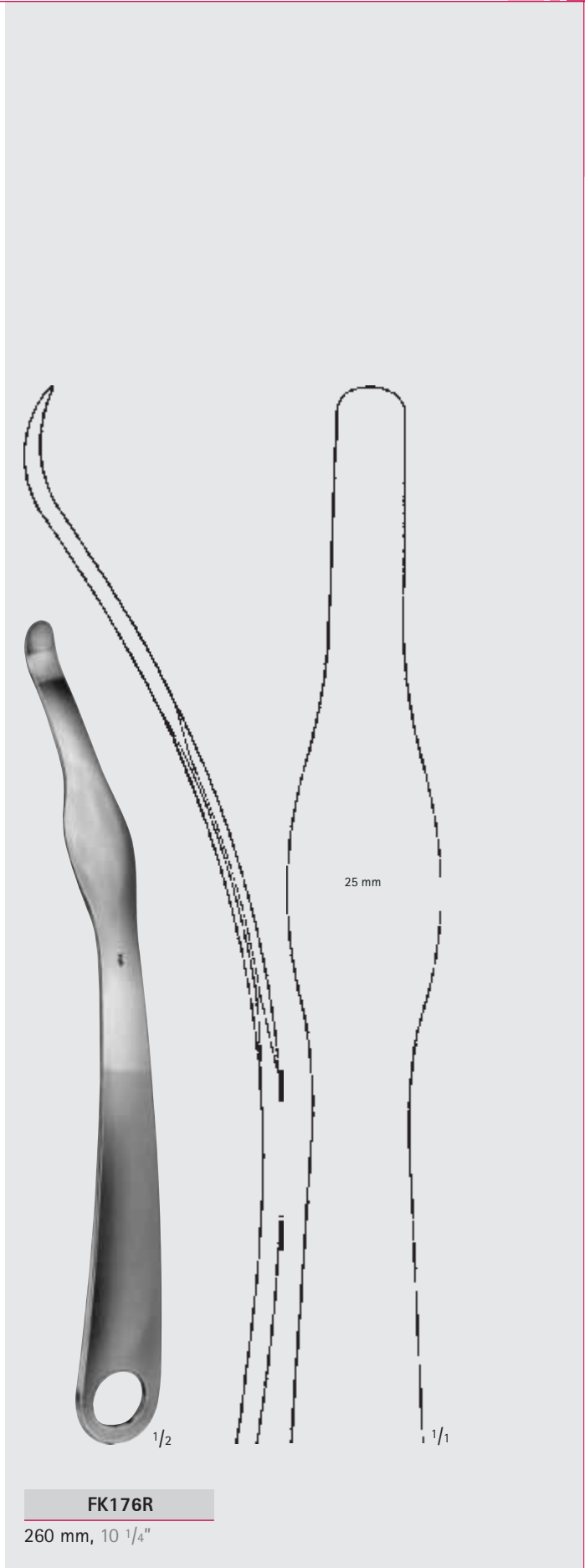
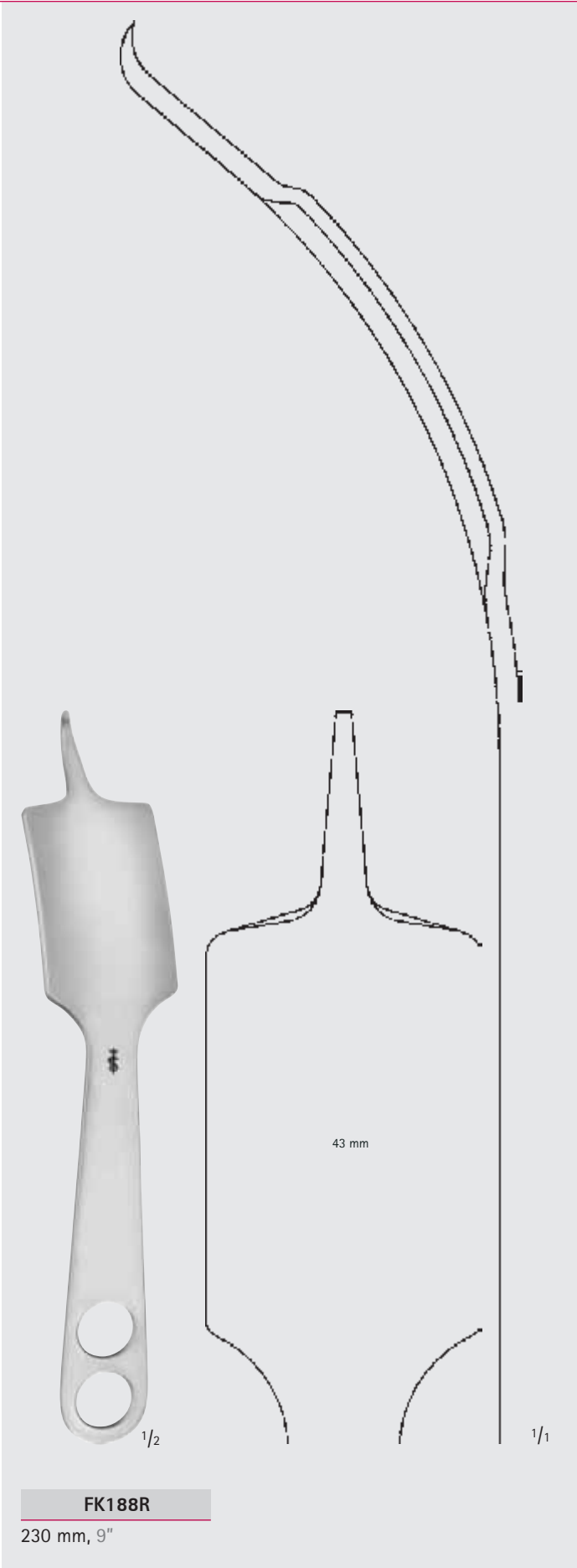

Knochenheber, Raspatorien, Scharfe Löffel – Bone Levers, Elevators, Bone Curettes

Knochenheber

Bone Levers

FK

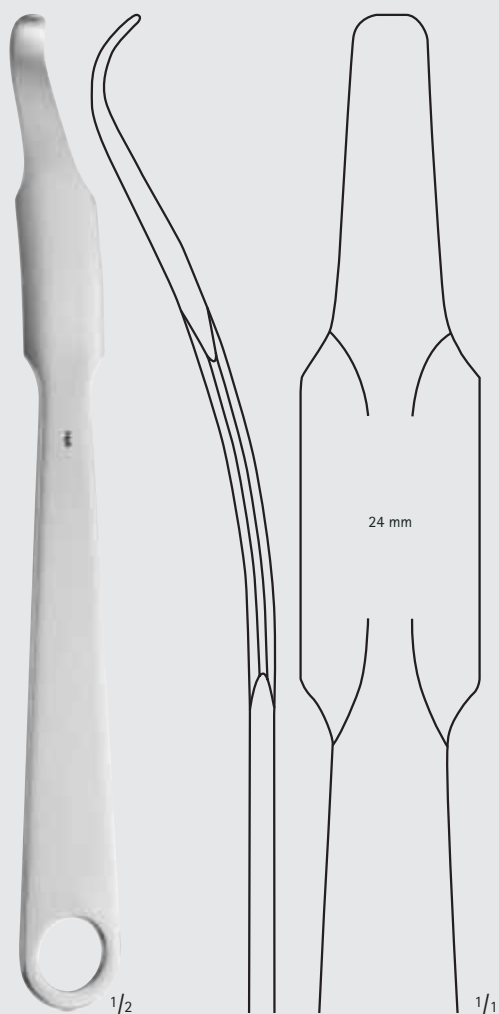

HOHMANN

FK172R

260 mm, 10 1/4"

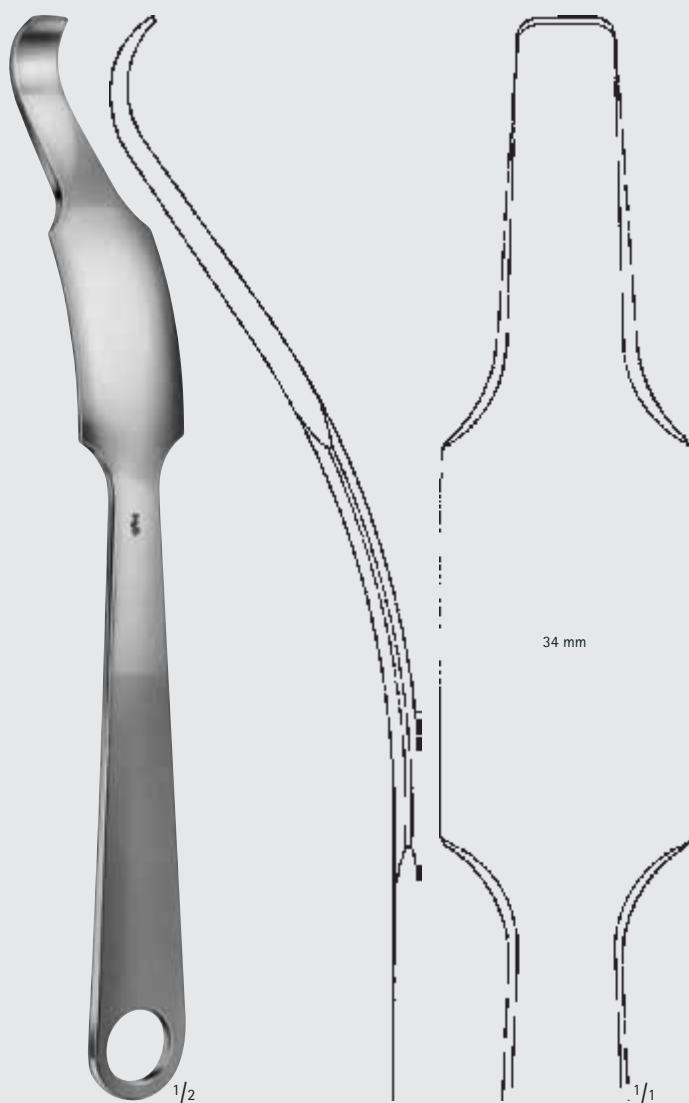

HOHMANN

FK173R

285 mm, 11 1/4"



Knochenheber, Raspatorien, Scharfe Löffel – Bone Levers, Elevators, Bone Curettes

Knochenheber
Bone Levers

FK

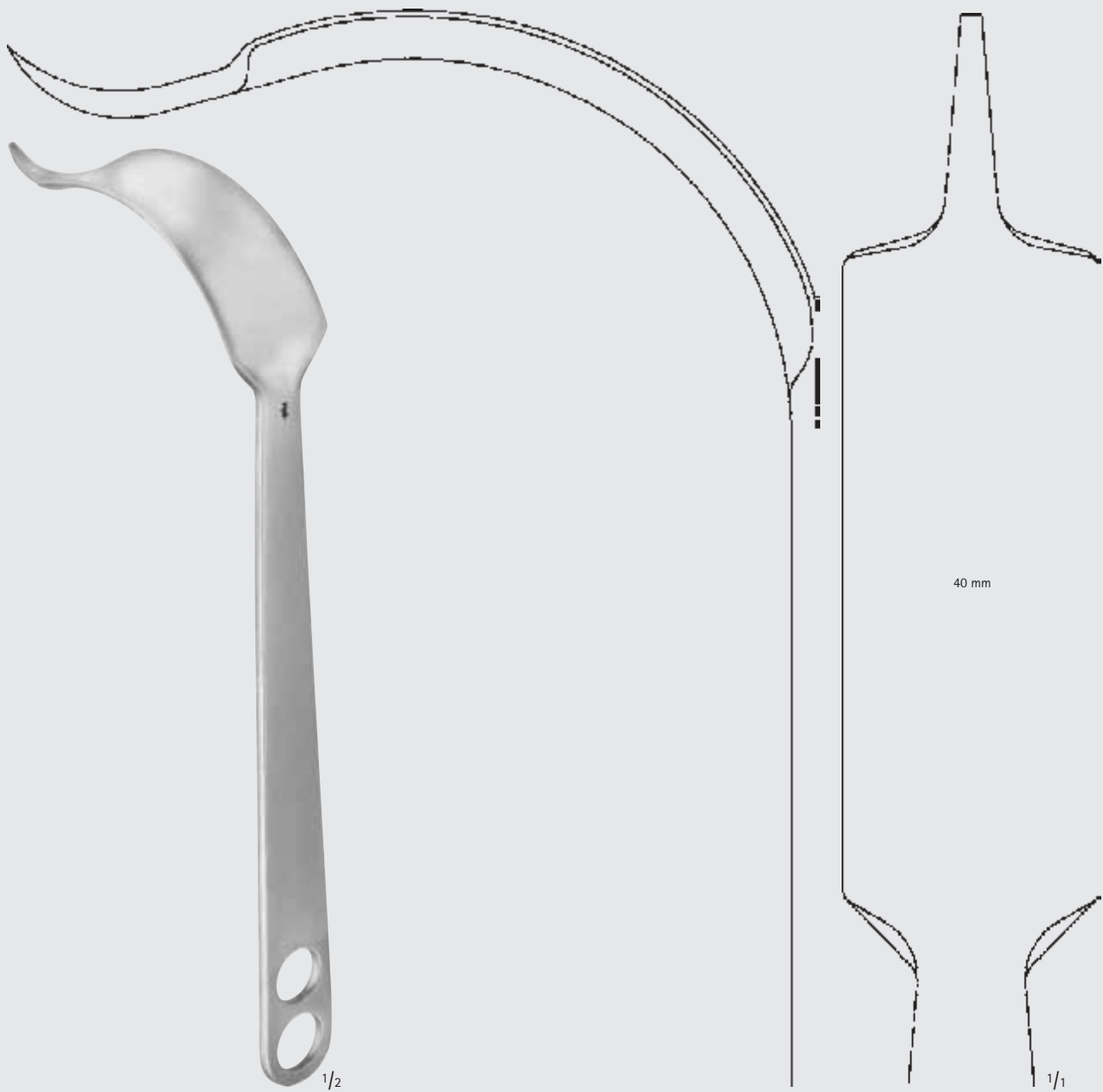

FK189R

290 mm, 11 1/2"

MILLIMETERS

Knochenheber, Raspatorien, Scharfe Löffel – Bone Levers, Elevators, Bone Curettes

Knochenheber

Bone Levers

FK



1/2

FK187R

300 mm, 12"

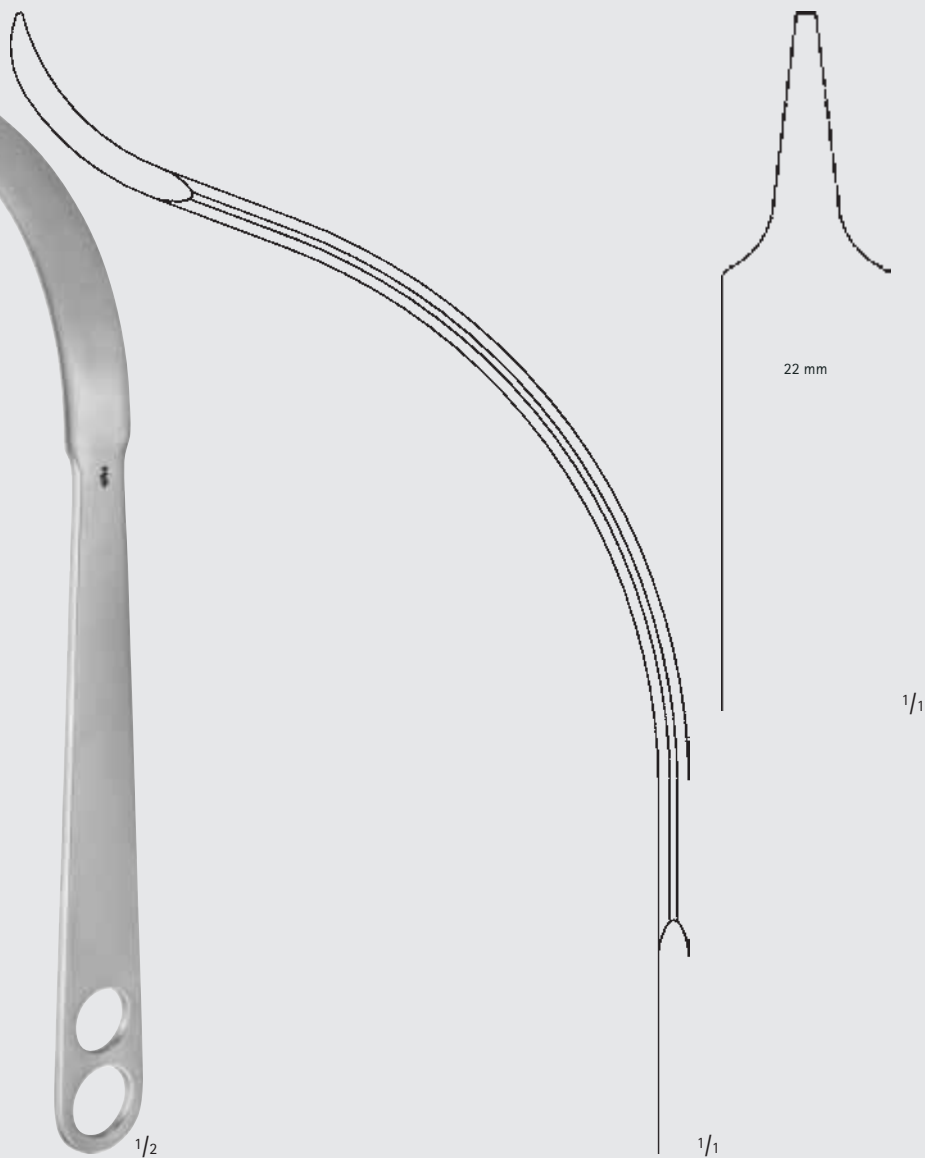

22 mm

1/1

1/1



Knochenheber, Raspatorien, Scharfe Löffel – Bone Levers, Elevators, Bone Curettes

Knochenheber
Bone Levers

FK

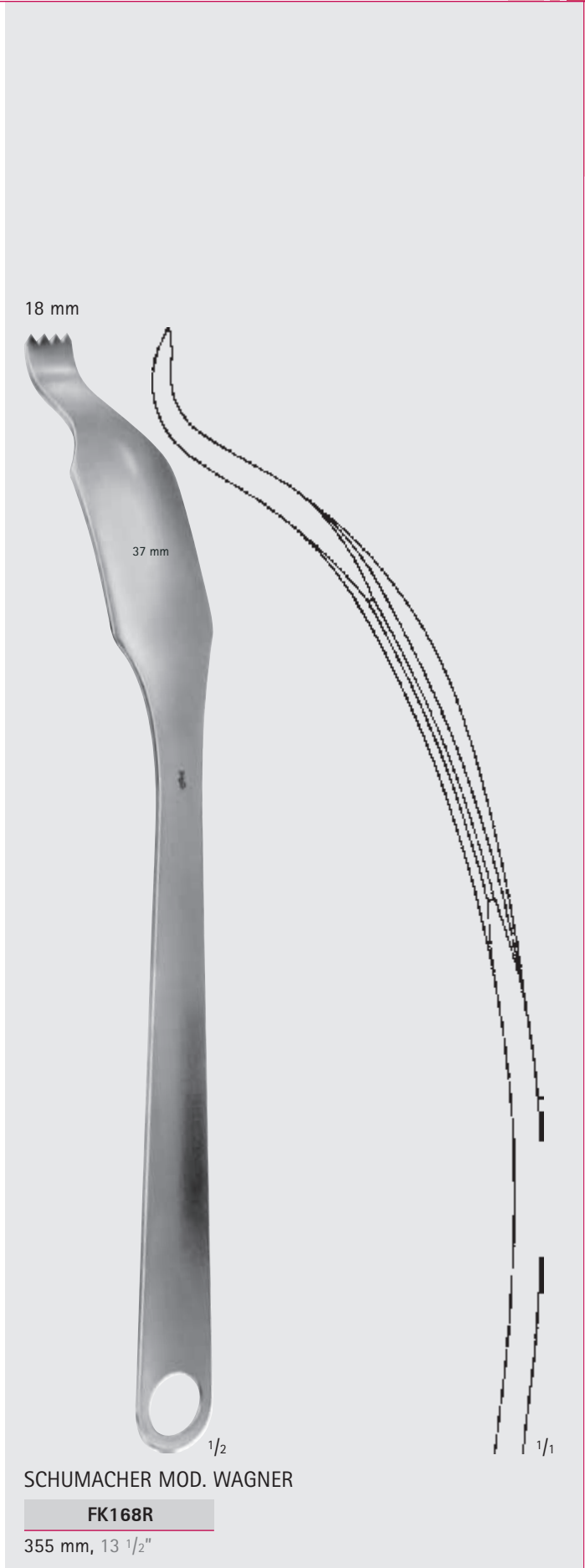
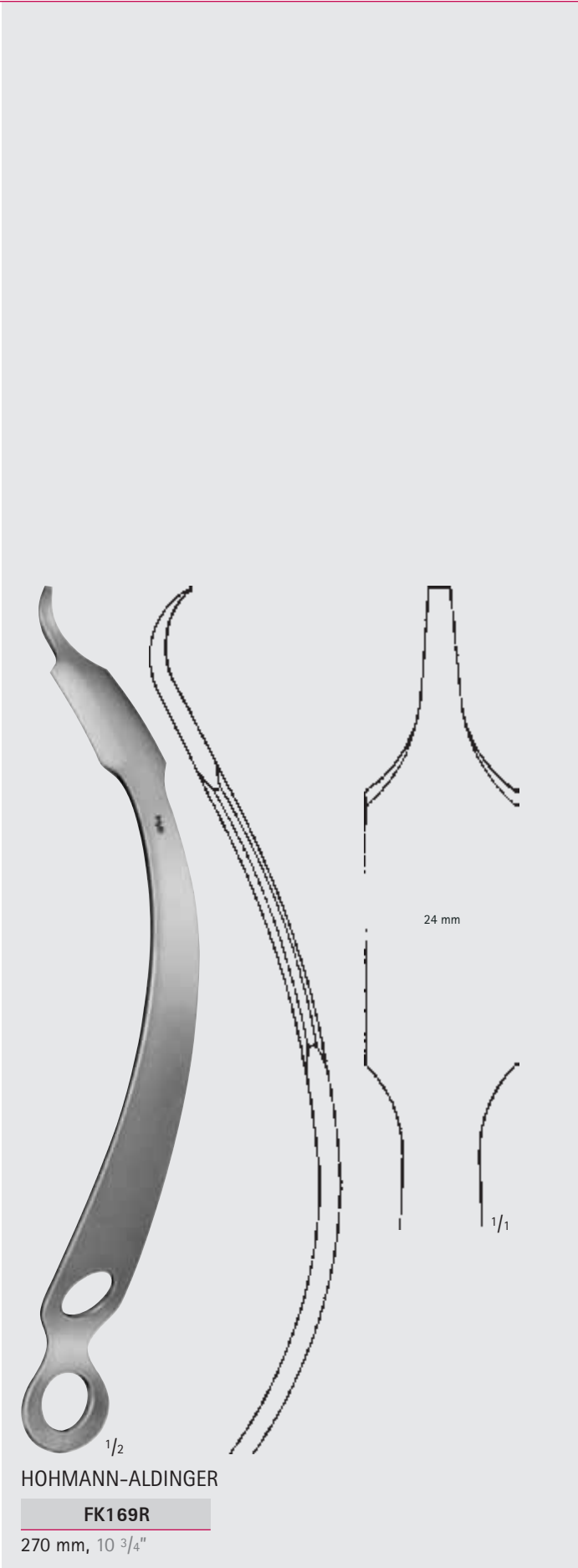

MILLIMETERS

Knochenheber, Raspatorien, Scharfe Löffel – Bone Levers, Elevators, Bone Curettes

Knochenheber, Spezial-Knochenheber

Bone Levers, Special Bone Levers

FK

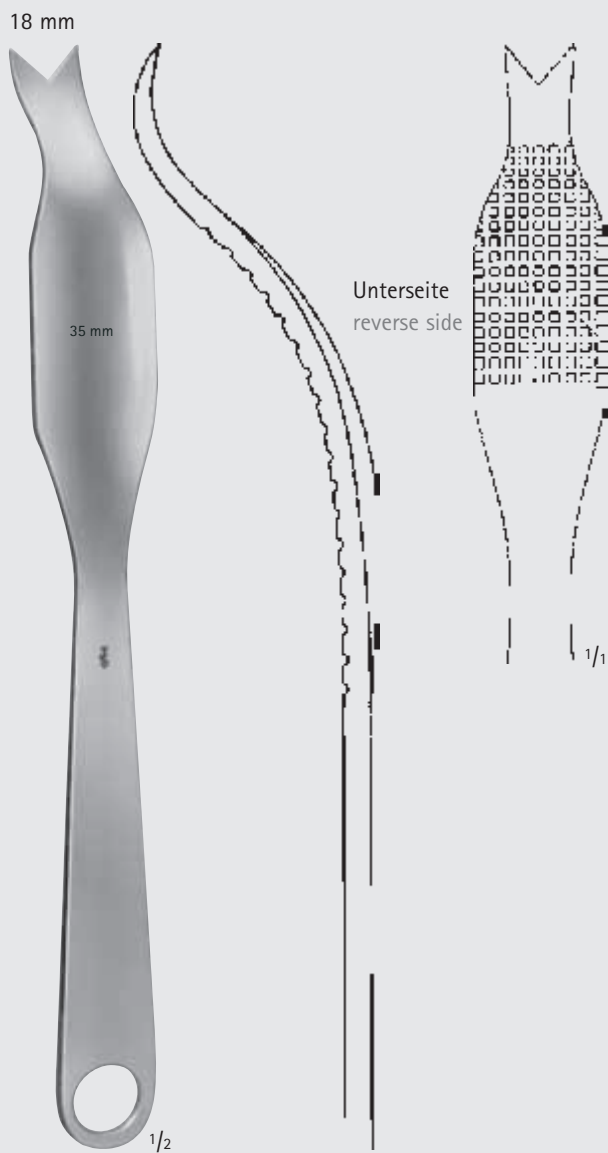

SCHUMACHER

FK177R

290 mm, 11 1/2"

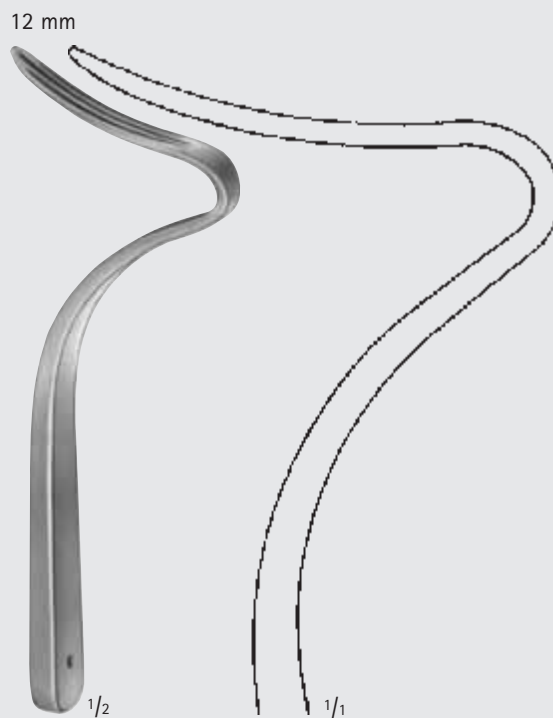

TÄGER

FK158R

Knochenheber für Fußgelenkoperationen

Bone lever for angle joint operations

175 mm, 7"



Knochenheber, Raspatorien, Scharfe Löffel – Bone Levers, Elevators, Bone Curettes

Spezial-Knochenheber
Special Bone Levers

FK

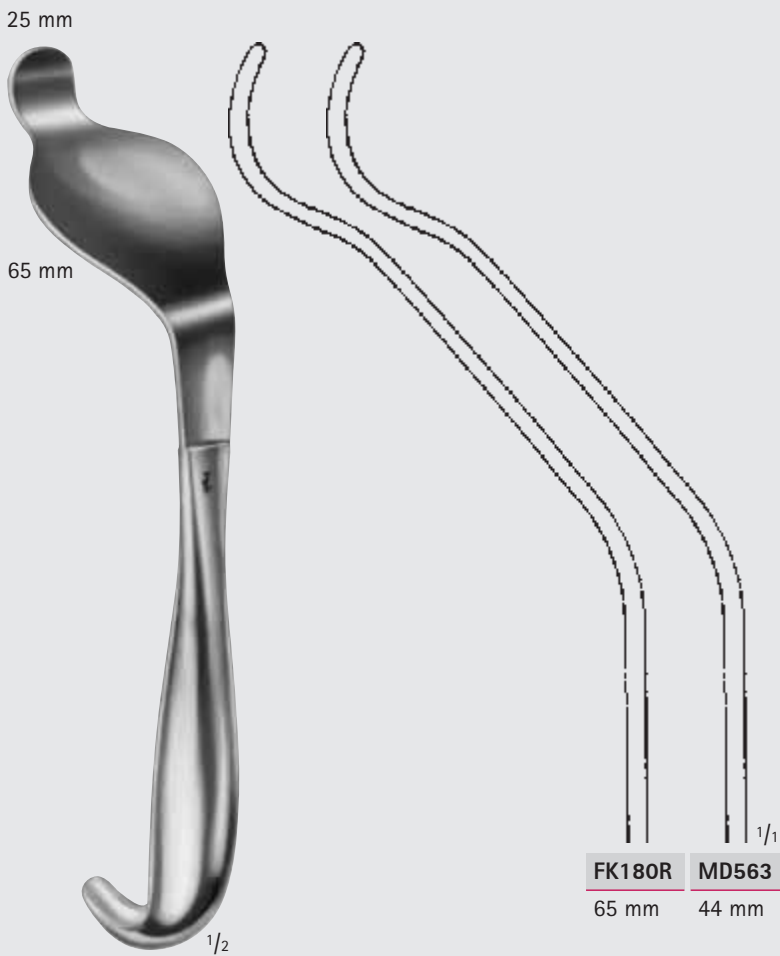

BENNETT

FK180R-MD563

235 mm, 9 1/4"



MURPHY-LANE

FK193R

Luxationsheber

Luxation lever

330 mm, 13 1/8"



MILLIMETERS

Knochenheber, Raspatorien, Scharfe Löffel – Bone Levers, Elevators, Bone Curettes

Retraktoren

Retractors

FK

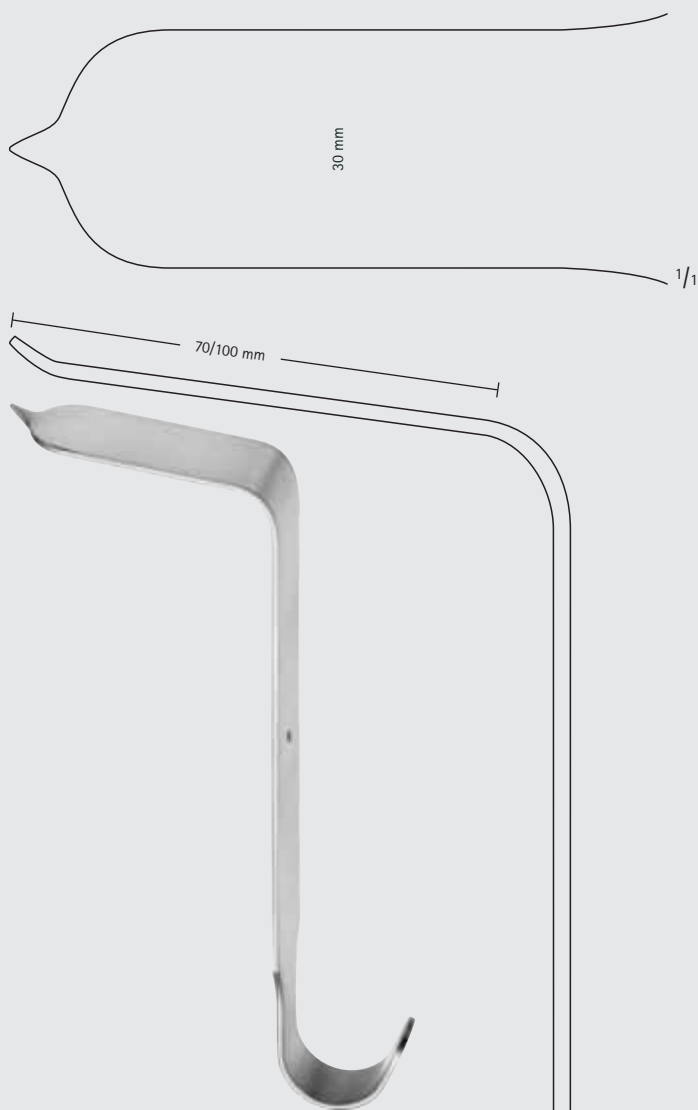

TAYLOR

Blattgröße:
Blade size:

BT501R	30 x 70 mm	185 mm	7 1/4"
BT502R	30 x 100 mm	200 mm	8"



HIBBS

BT503R–BT505R

235 mm, 9 1/8"



Knochenheber, Raspatorien, Scharfe Löffel – Bone Levers, Elevators, Bone Curettes

MIOS Retraktoren

MIOS Retractors

FK

90°

FK213R

FK212R

FK211R

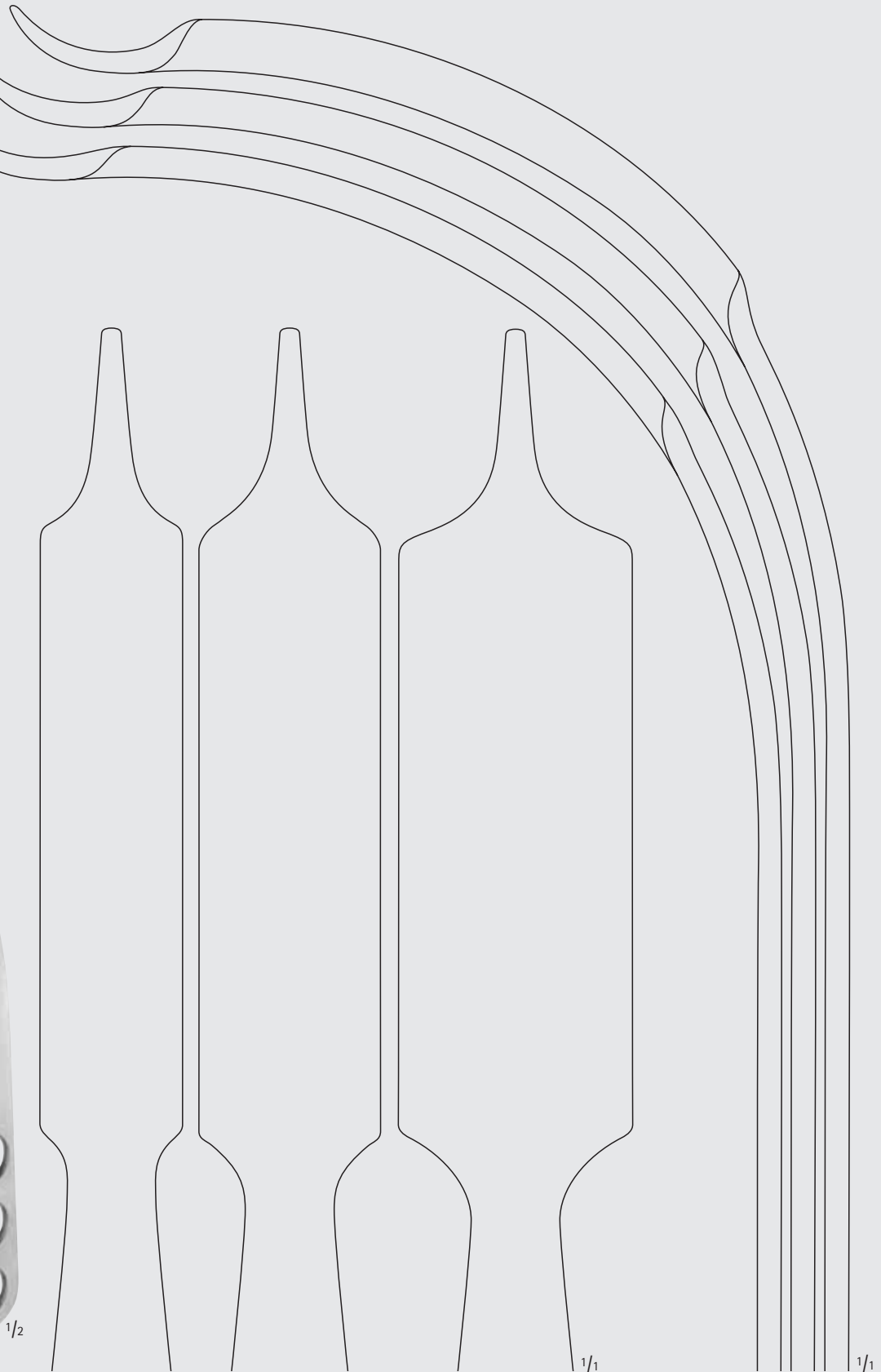

FK211R-FK213R

scharfe Spitze
sharp tip
240 mm, 9 1/2"

FK211R

22 mm

FK212R

28 mm

FK213R

40 mm

MILLIMETERS

Knochenheber, Raspatorien, Scharfe Löffel – Bone Levers, Elevators, Bone Curettes

MIOS Retraktoren

MIOS Retractors

90°

FK219R

FK218R

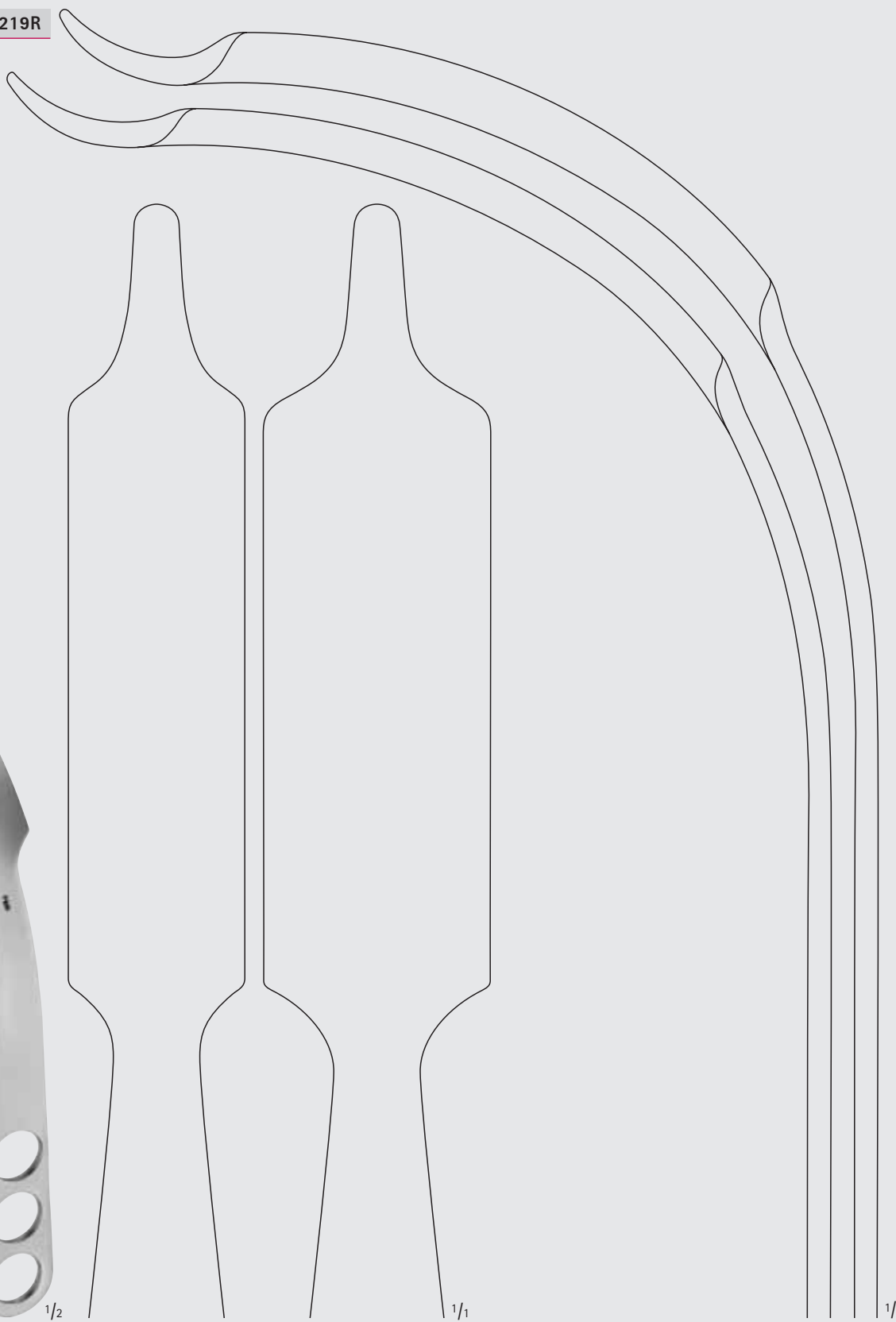

FK218R-FK219R

FK218R

28 mm

FK219R

40 mm

stumpfe Spitze

blunt tip

240 mm, 9 1/2"

INCHES



Knochenheber, Raspatorien, Scharfe Löffel – Bone Levers, Elevators, Bone Curettes

MIOS Retraktoren

MIOS Retractors

FK

90°

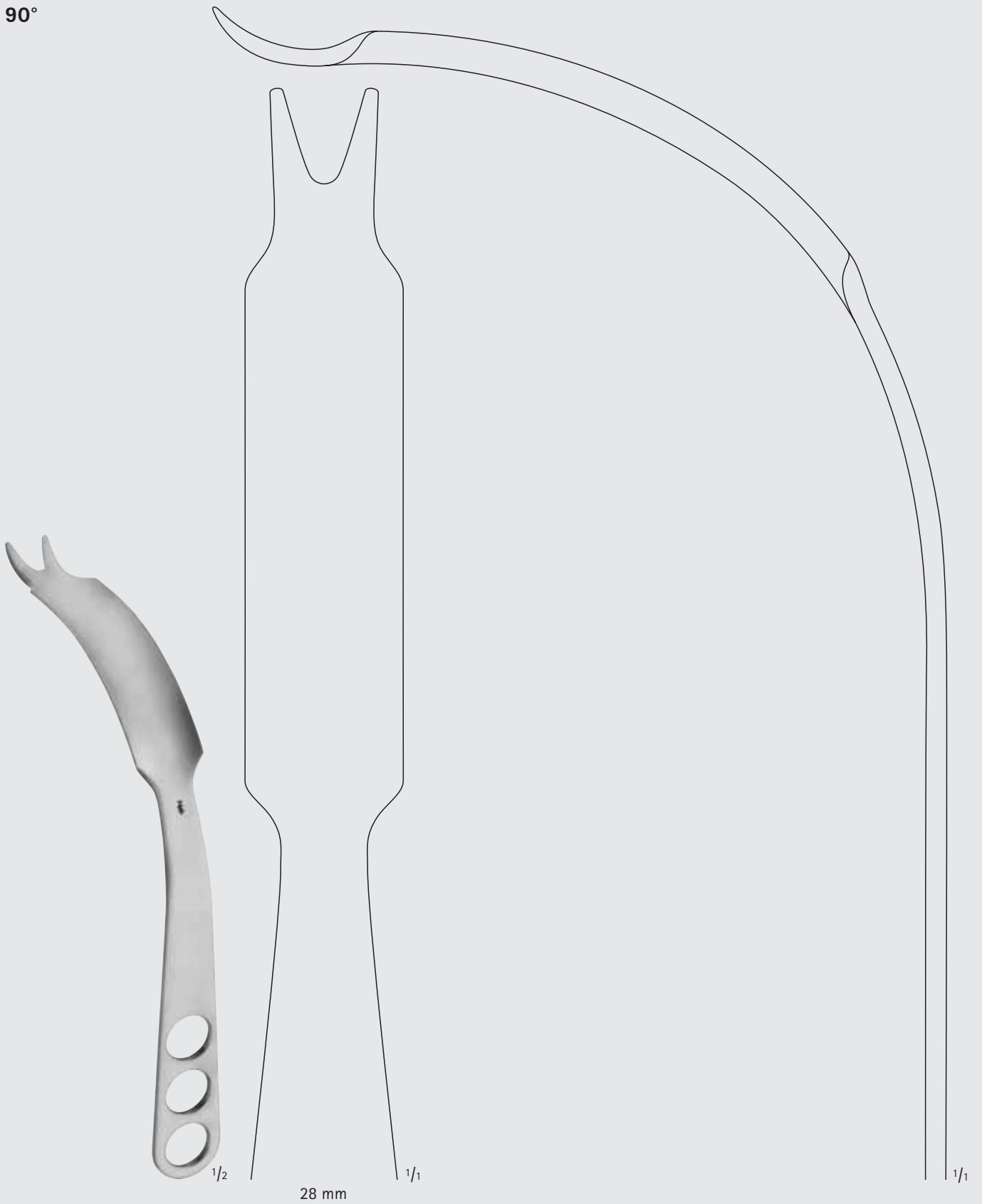

FK224R

V-Spitze

V-tip

240 mm, 9 1/2"

MILLIMETERS

Knochenheber, Raspatorien, Scharfe Löffel – Bone Levers, Elevators, Bone Curettes

MIOS Retraktoren

MIOS Retractors

90°

FK214R

FK215R



1/2

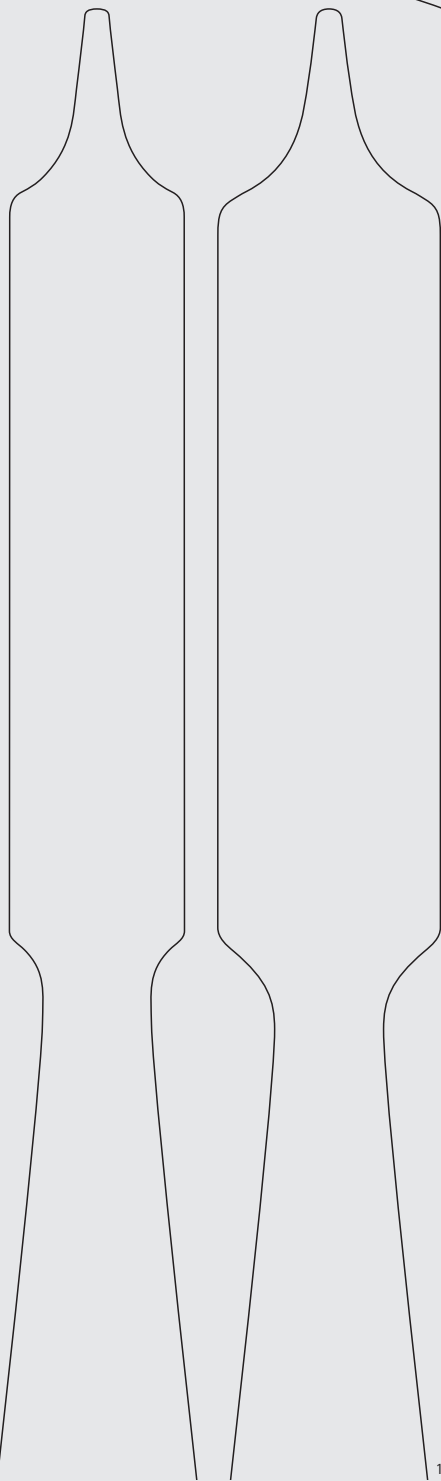

FK214R

22 mm

FK215R

28 mm

1/1

1/1

FK214R-FK215R

kurze Spitze

short tip

240 mm, 9 1/2"

INCHES





Knochenheber, Raspatorien, Scharfe Löffel – Bone Levers, Elevators, Bone Curettes

MIOS Retraktoren

MIOS Retractors

FK

90°

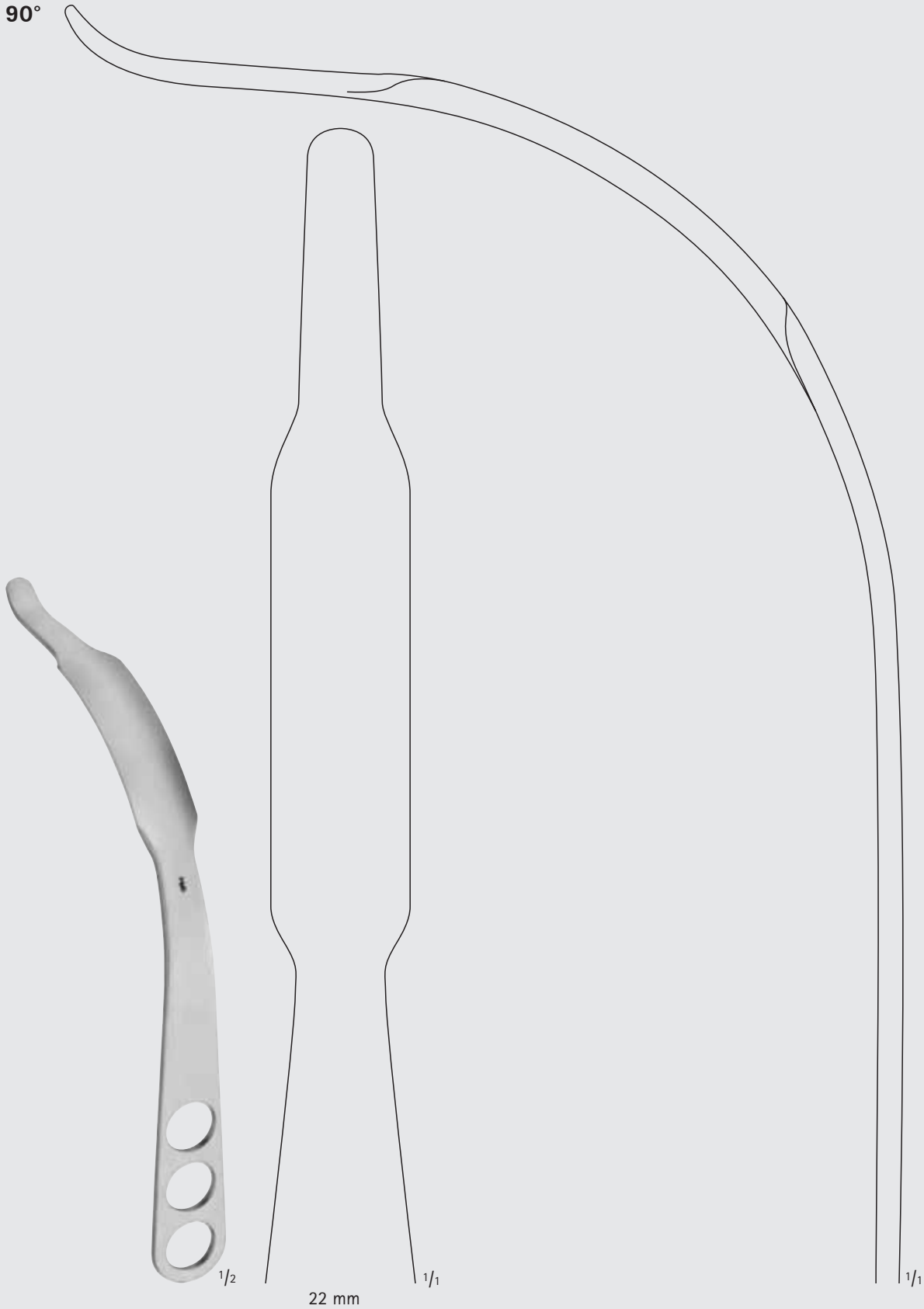

FK239R

Schenkelhals-Spitze

femoral neck tip

240 mm, 9 1/2"

MILLIMETERS

Knochenheber, Raspatorien, Scharfe Löffel – Bone Levers, Elevators, Bone Curettes

MIOS Retraktoren

MIOS Retractors

FK

60°

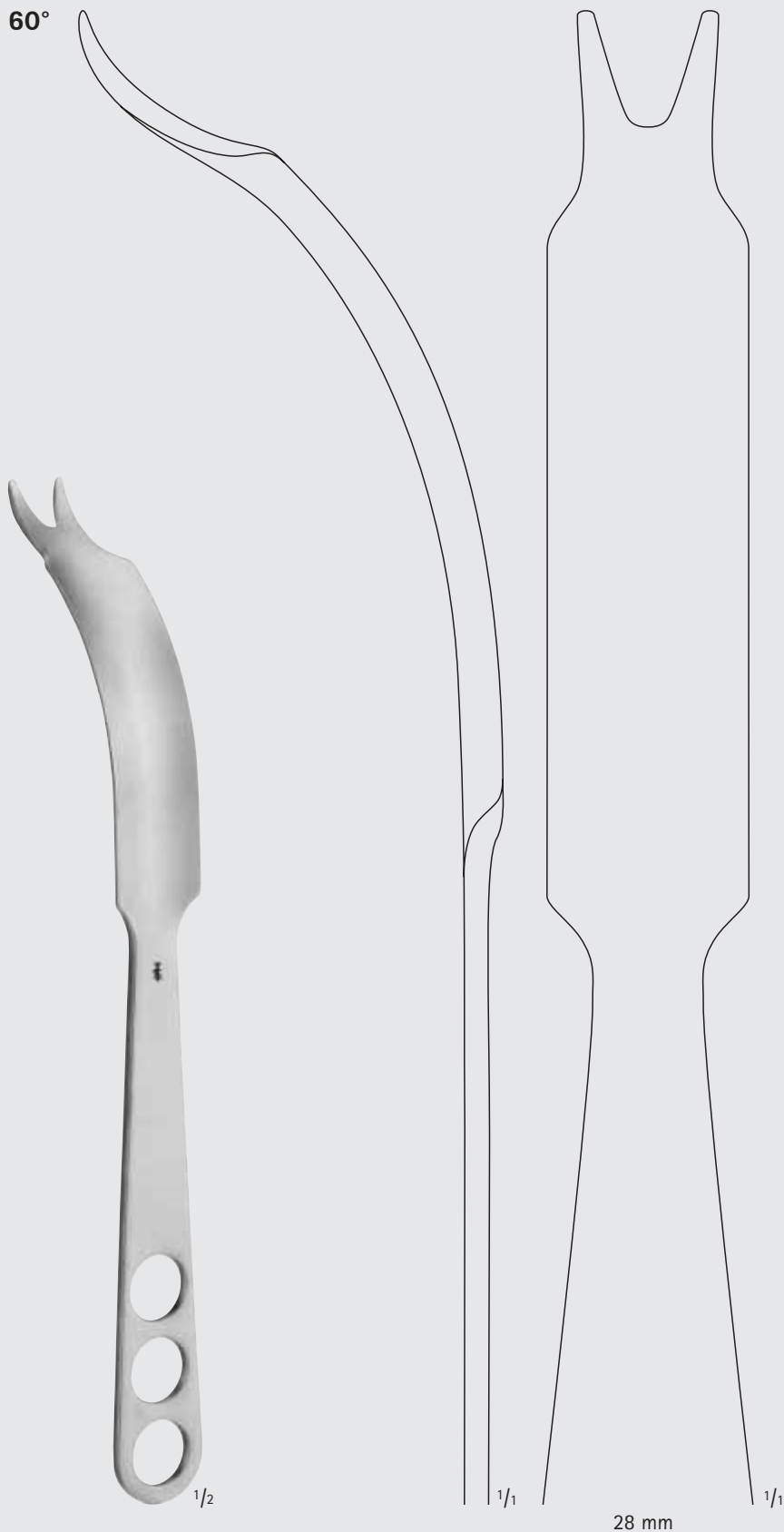

FK223R

V-Spitze

V-tip

300 mm, 12"



Knochenheber, Raspatorien, Scharfe Löffel – Bone Levers, Elevators, Bone Curettes

MIOS Retraktoren

MIOS Retractors

FK

45°

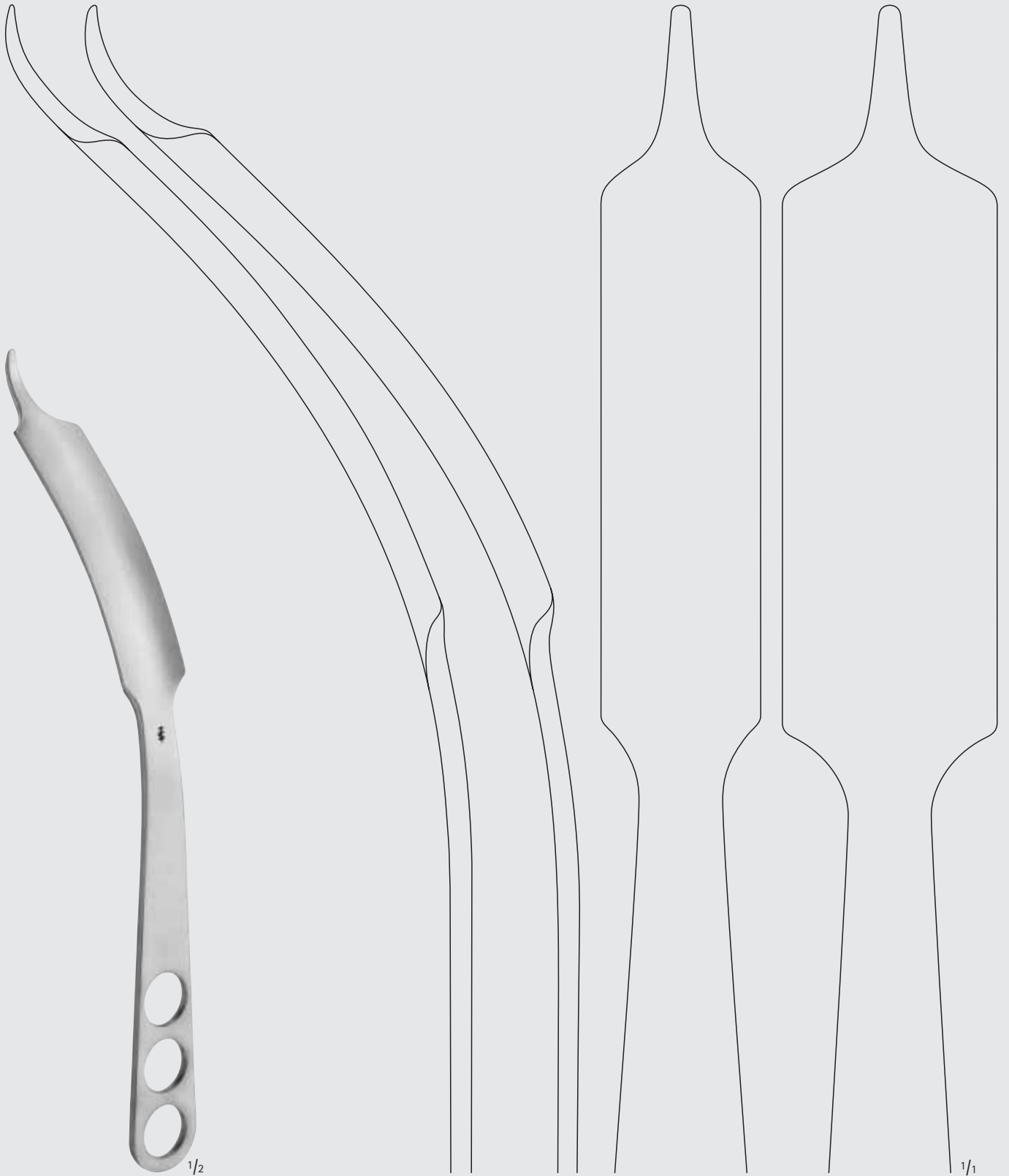

1/2

1/1

FK243R-FK245R

scharfe Spitze

sharp tip

300 mm, 12"

FK243R

28 mm

FK245R

40 mm

MILLIMETERS

Knochenheber, Raspatorien, Scharfe Löffel – Bone Levers, Elevators, Bone Curettes

MIOS Retraktoren

MIOS Retractors

45°

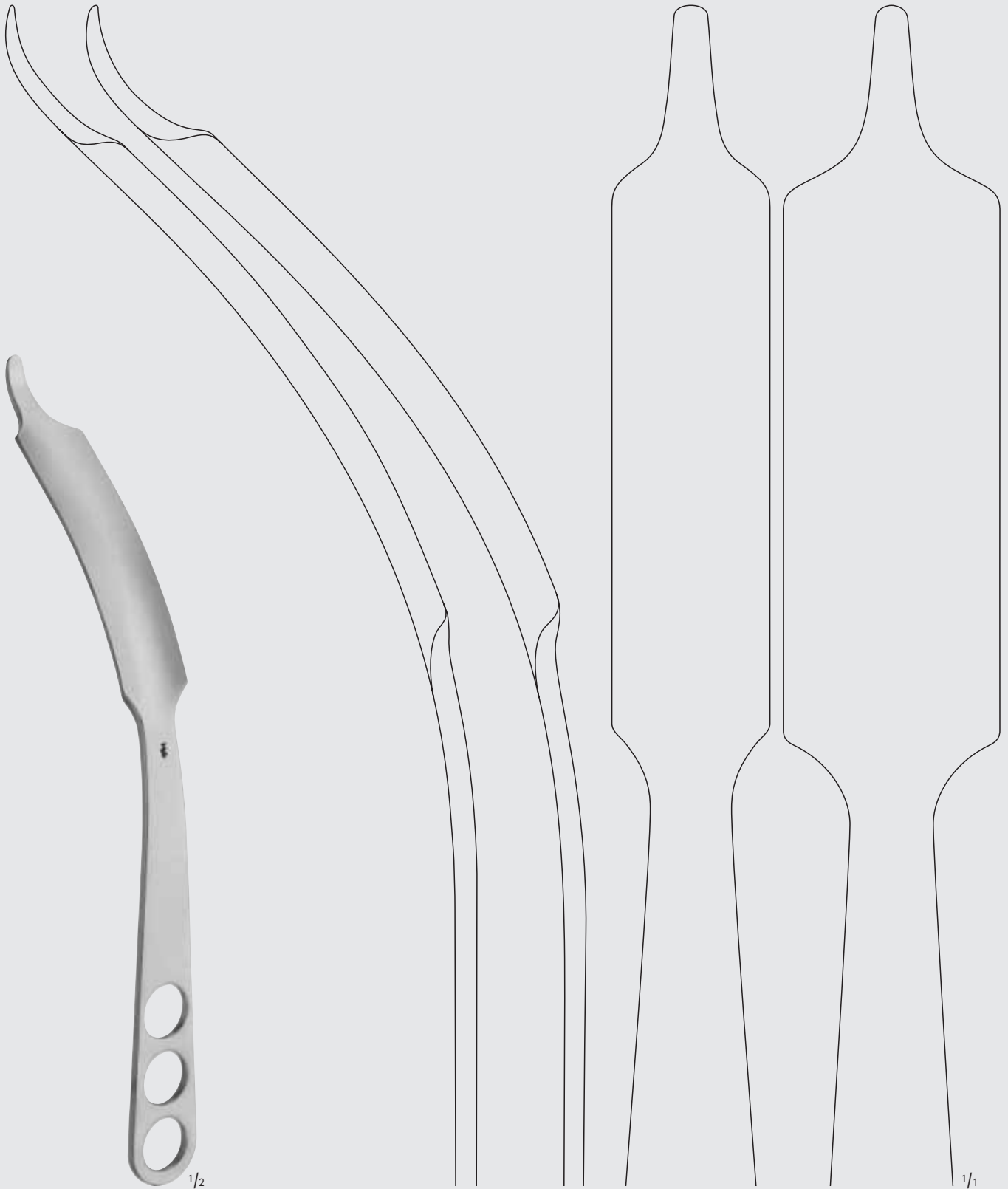

FK244R-FK246R

stumpfe Spitze

blunt tip

300 mm, 12"

FK244R

28 mm

FK246R

40 mm



Knochenheber, Raspatorien, Scharfe Löffel – Bone Levers, Elevators, Bone Curettes

MIOS Retraktoren

MIOS Retractors

FK

45°

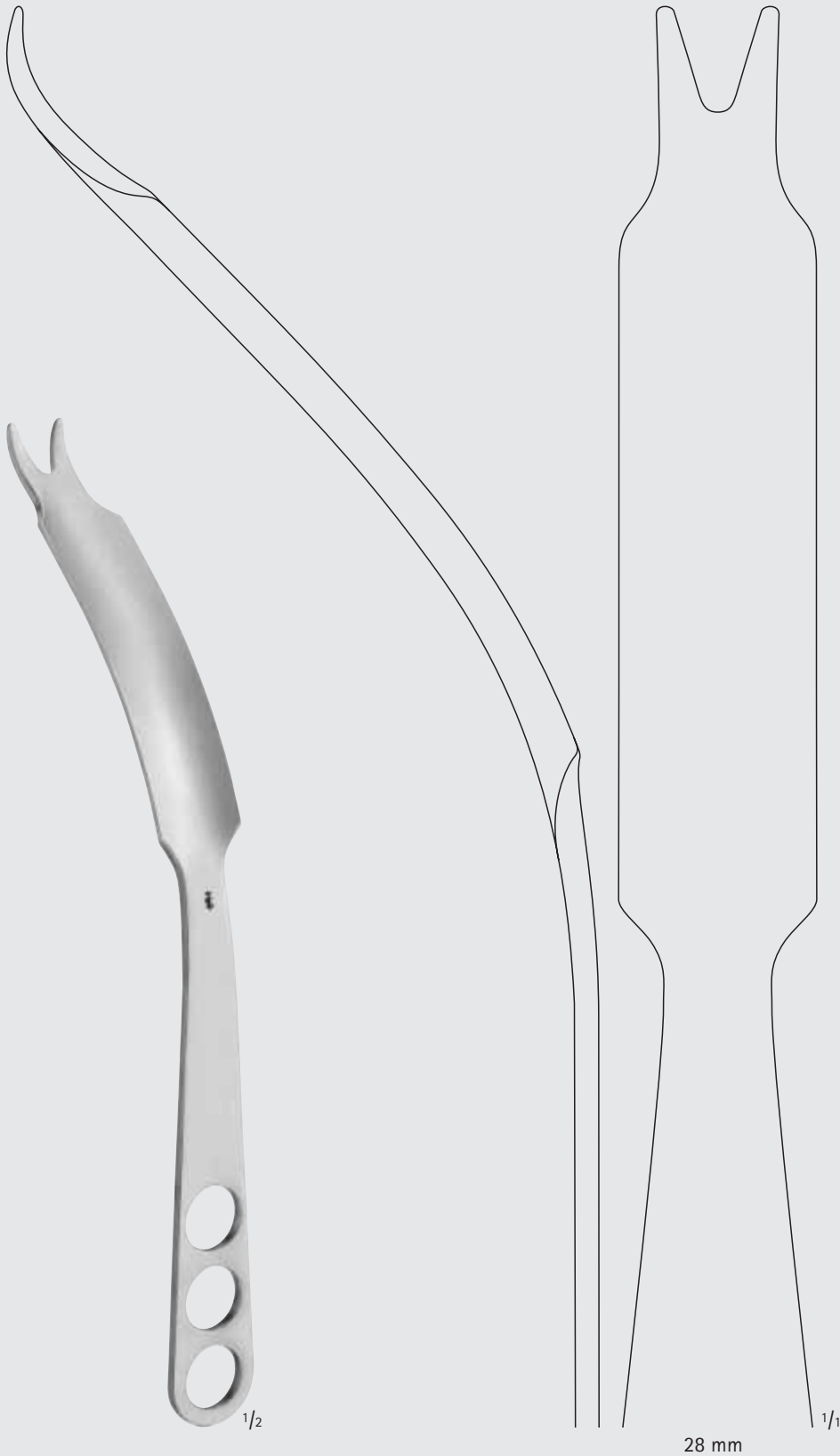

FK222R

V-Spitze

V-tip

300 mm, 12"



MILLIMETERS

Knochenheber, Raspatorien, Scharfe Löffel – Bone Levers, Elevators, Bone Curettes

MIOS Retraktoren

MIOS Retractors

FK

30°

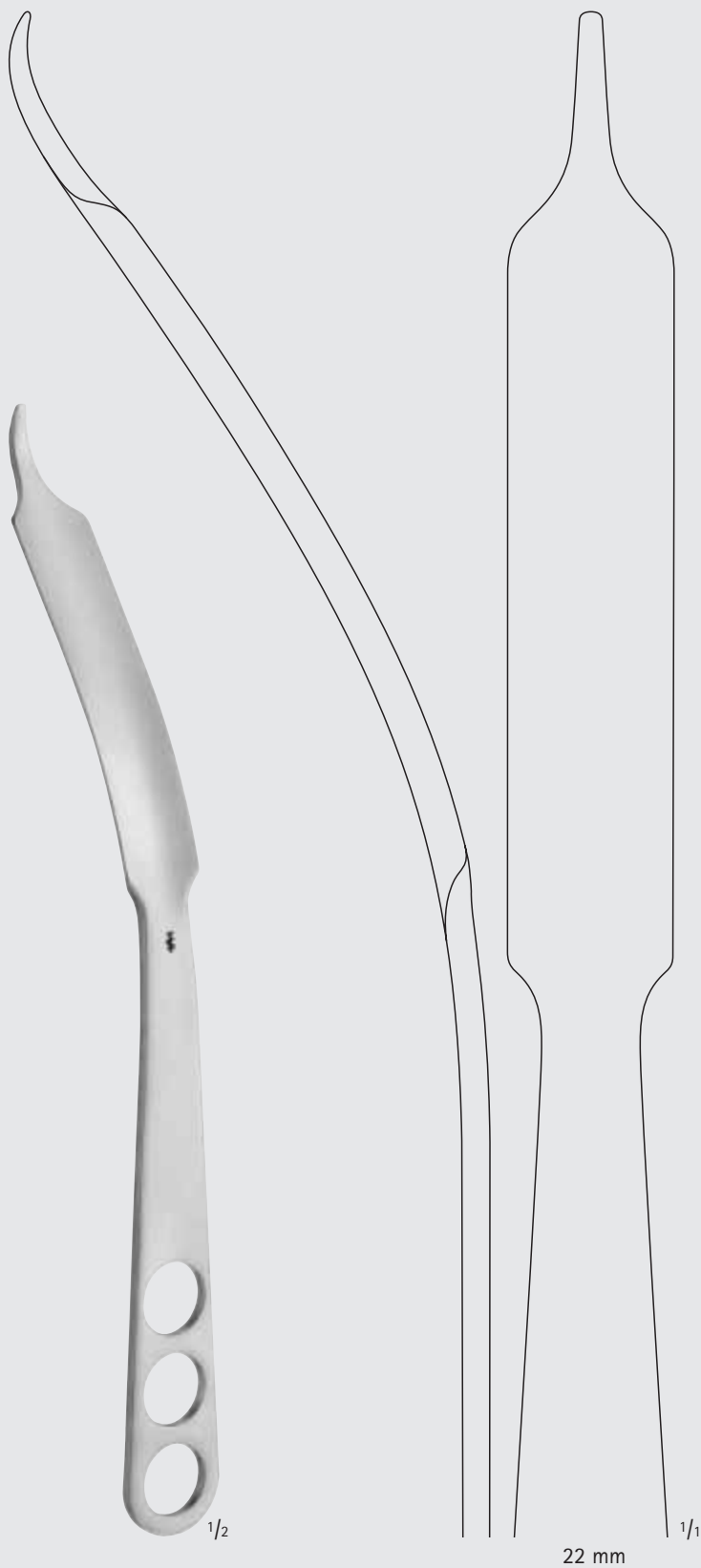

FK241R

scharfe Spitze

sharp tip

315 mm, 12 1/2"

22 mm

1/1

INCHES



Knochenheber, Raspatorien, Scharfe Löffel – Bone Levers, Elevators, Bone Curettes

MIOS Retraktoren

MIOS Retractors

FK

30°

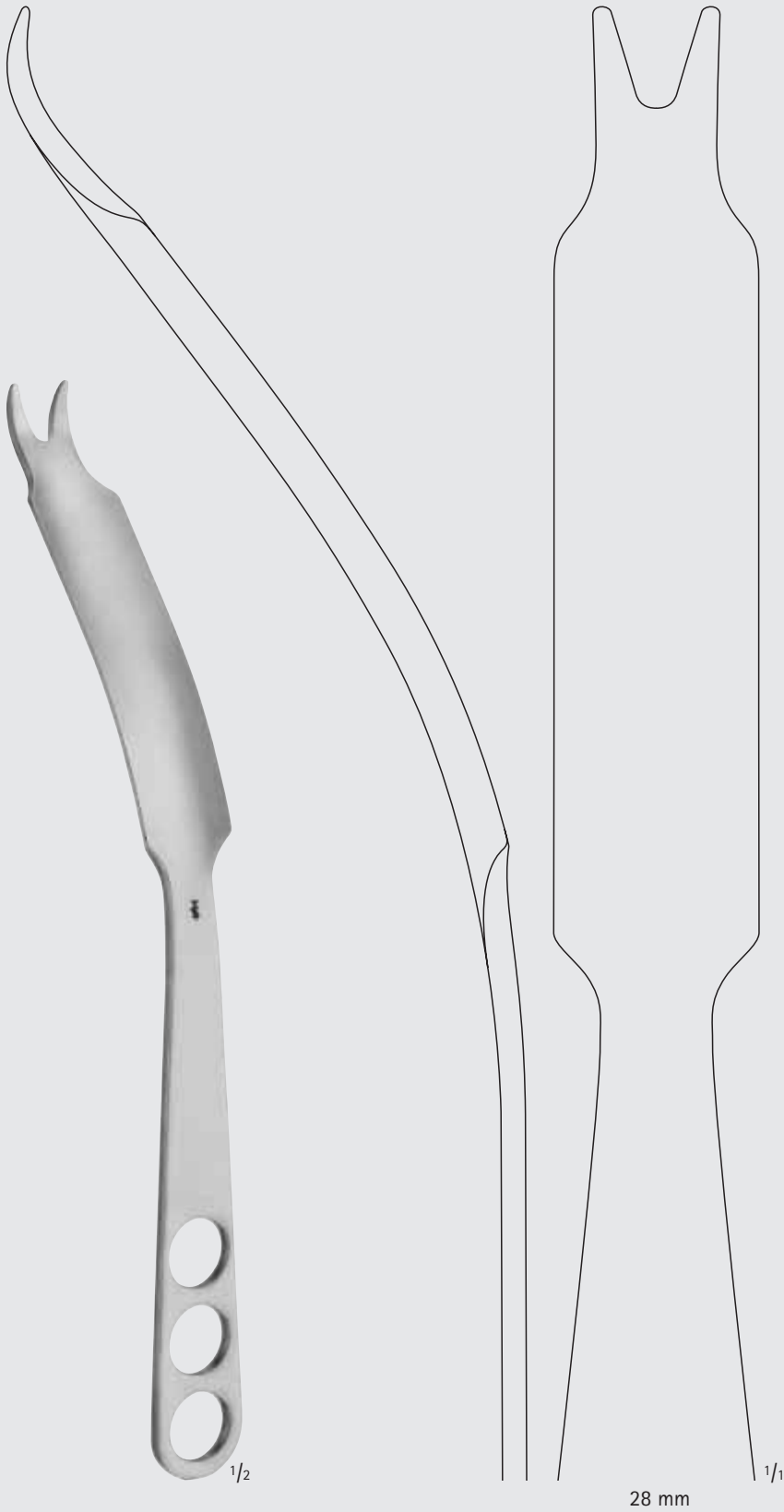

FK221R

V-Spitze

V-tip

315 mm, 12 1/2"



Knochenheber, Raspatorien, Scharfe Löffel – Bone Levers, Elevators, Bone Curettes

MIOS Retraktoren

MIOS Retractors

30°

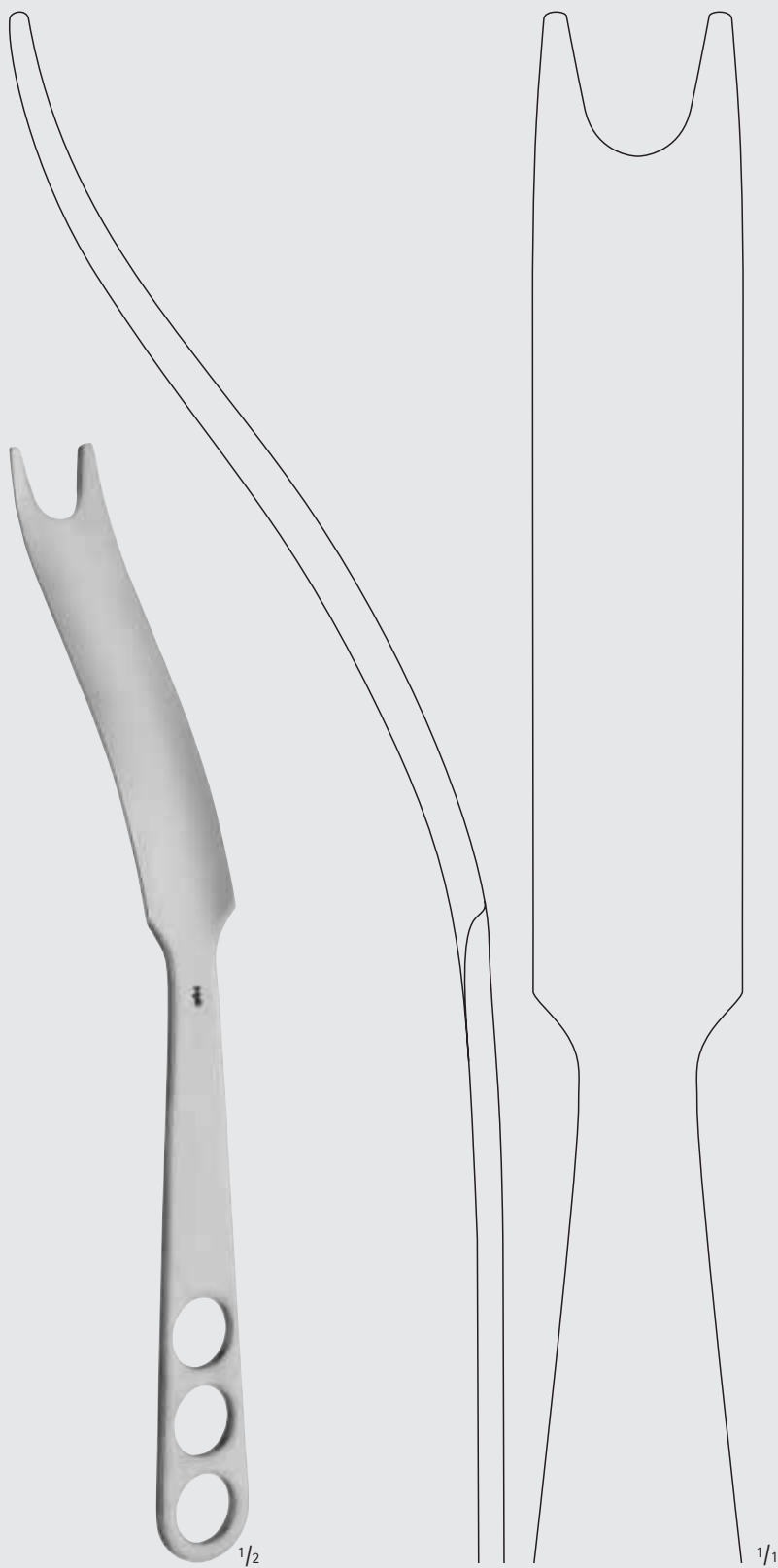

FK231R

U-Spitze

U-tip

315 mm, 12 1/2"

28 mm

1/2

1/1

INCHES



Knochenheber, Raspatorien, Scharfe Löffel – Bone Levers, Elevators, Bone Curettes

MIOS Retraktoren

MIOS Retractors

FK

30°

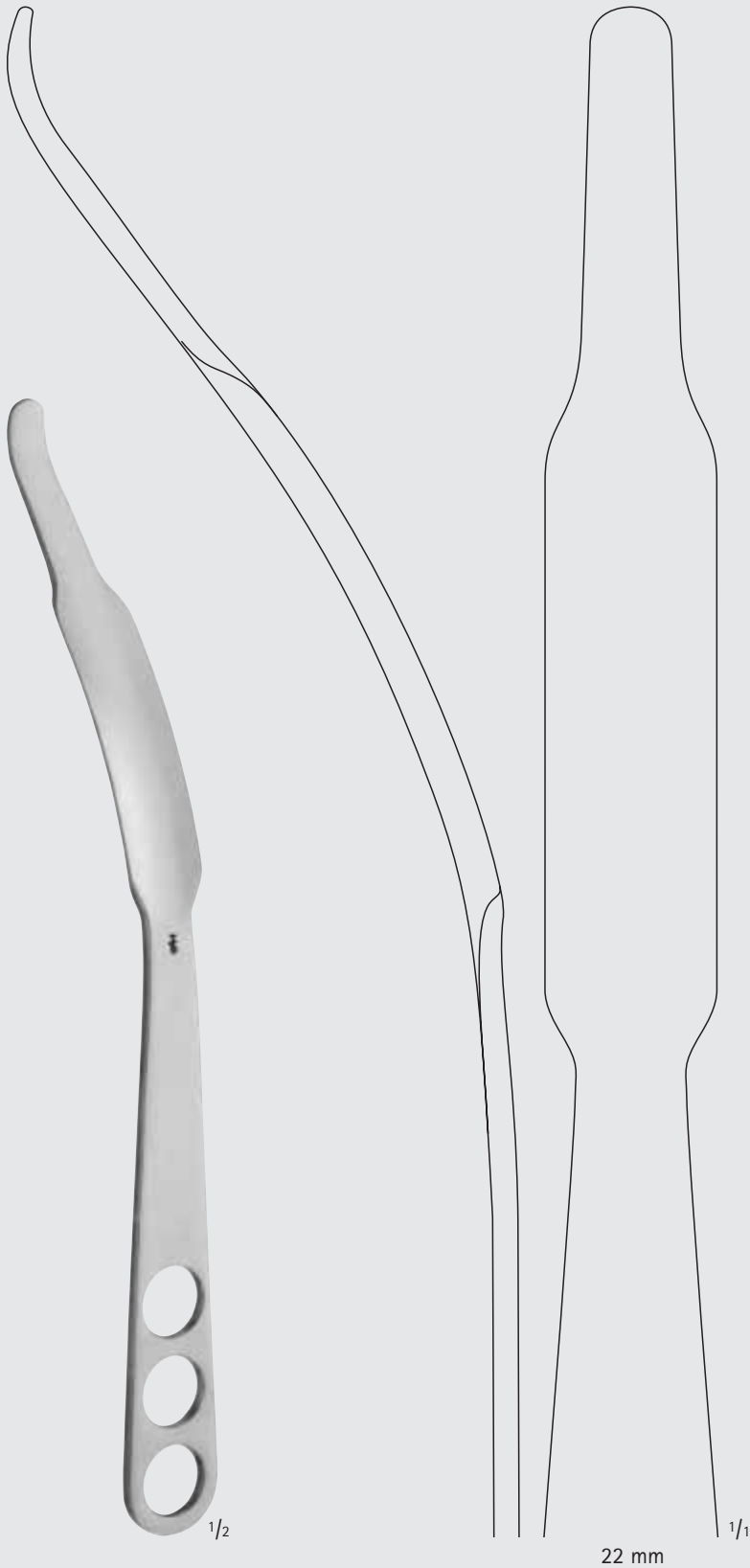

FK238R

Schenkelhals-Spitze
femoral neck tip
315 mm, 12 1/2"



Farbige MIOS Standardgriffe

Die farbigen Griffe können zur intraoperativen Zuordnung der MIOS Instrumente verwendet werden.

Colored MIOS standard hand grips

The colored hand grips can be used for the intra-operative allocation of the MIOS instruments.



1/2

FK251

MIOS Standardgriff
MIOS standard hand grip



1/2

FK252

MIOS Standardgriff
MIOS standard hand grip



1/2

FK253

MIOS Standardgriff
MIOS standard hand grip



1/2

FK254

MIOS Standardgriff
MIOS standard hand grip

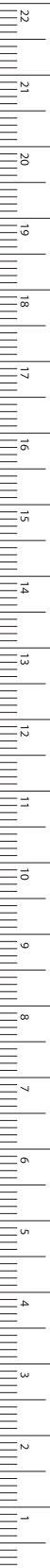

MILLIMETERS

Knochenheber, Raspatorien, Scharfe Löffel – Bone Levers, Elevators, Bone Curettes

Raspatorien

Raspatories

FK

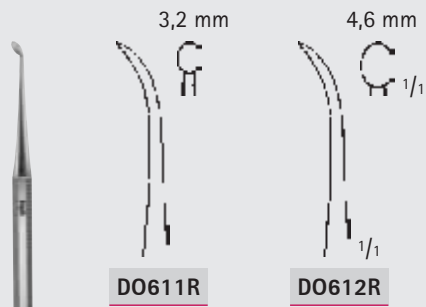

DO611R

DO612R

1/2

PARTSCH

DO611R-DO612R

150 mm, 6"

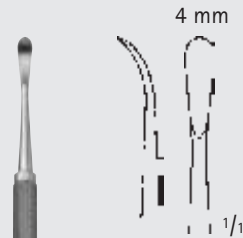

1/2

PARTSCH MOD. LANGE

DO642R

145 mm, 5 3/4"

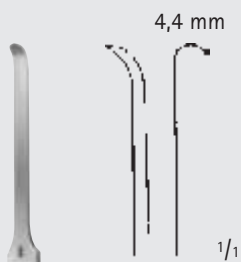

1/2

MC KENTY

OL192R

115 mm, 6"

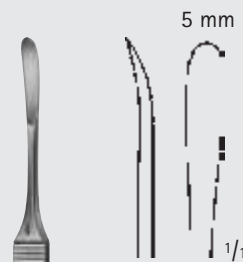

1/2

KÖNIG

OM309R

155 mm, 6"

Knochenheber, Raspatorien, Scharfe Löffel – Bone Levers, Elevators, Bone Curettes

Raspatorien
Raspatories

FK

8 mm

1/2

TRELAT

OM311R

150 mm, 6"

4 mm

4 mm

1/1

OM314R **OM315R**

1/2

OM314R-OM315R

140 mm, 5 1/2"

4,2 mm

1/1

1/2

WILLIGER

D0510R

140 mm, 5 1/2"

6 mm

8 mm

1/1

FK300R **FK303R**

1/2

WILLIGER

FK300R-FK303R

160 mm, 6 1/4"

5,5 mm

1/1

1/2

WARD

D0546R

170 mm, 6 3/4"

4 mm

1/1

1/2

JOSEPH

FK310R

180 mm, 7"



Knochenheber, Raspatorien, Scharfe Löffel – Bone Levers, Elevators, Bone Curettes

Raspatorien

Raspatories

FK



LEMPERT

OG165R

Raspatorium, stumpf

Raspatory, blunt

165 mm, 6 1/2"

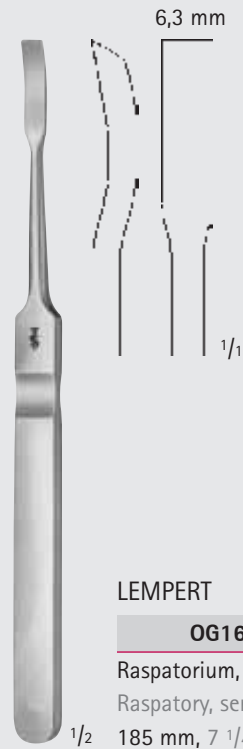

LEMPERT

OG164R

Raspatorium, halbscharf

Raspatory, semi-sharp

185 mm, 7 1/4"



ALLEN

FF346R

Osteophytenmeißel und Schaber

Osteophyte chisel and scraper

230 mm, 9"



Knochenheber, Raspatorien, Scharfe Löffel – Bone Levers, Elevators, Bone Curettes

Raspatorien
Raspatories

FK

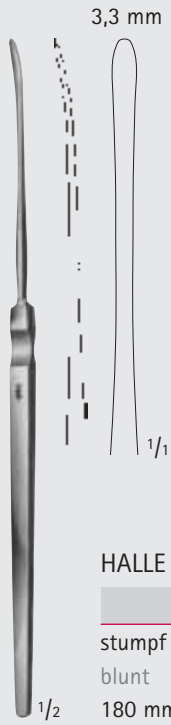

HALLE

OL160R

stumpf

blunt

180 mm, 7"



FREER

OL163R

stumpf

blunt

190 mm, 7 1/2"



FREER

OL162R

scharf

sharp

190 mm, 7 1/2"



SEWALL

OL198R

stumpf

blunt

200 mm, 8"

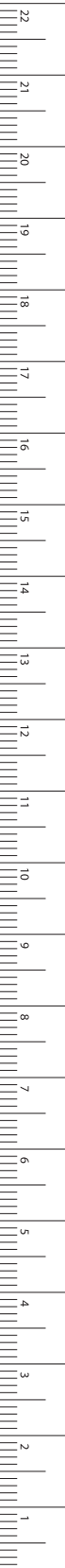

MILLIMETERS

Knochenheber, Raspatorien, Scharfe Löffel – Bone Levers, Elevators, Bone Curettes

Raspatorien

Raspatories

FK

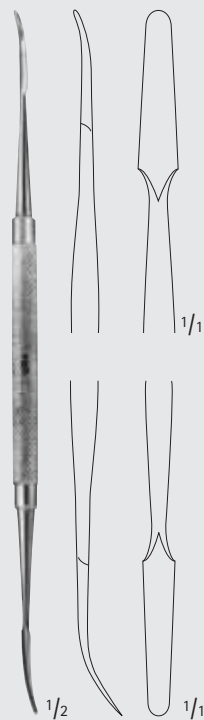

KILLIAN

OL170R

scharf/stumpf
sharp/blunt

185 mm, 7 1/4"



HOWARTH

OL171R

scharf/stumpf
sharp/blunt

215 mm, 8 1/2"

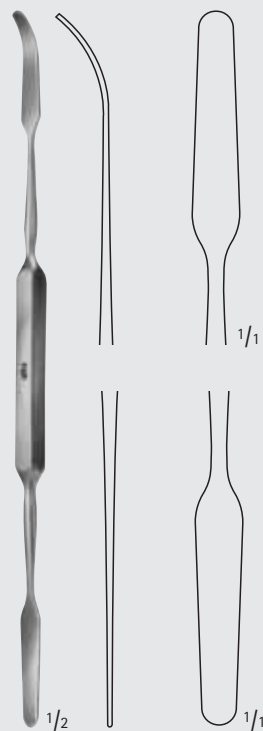

MAC DONALD

FK291R

stumpf/stumpf
blunt/blunt

190 mm, 7 1/2"

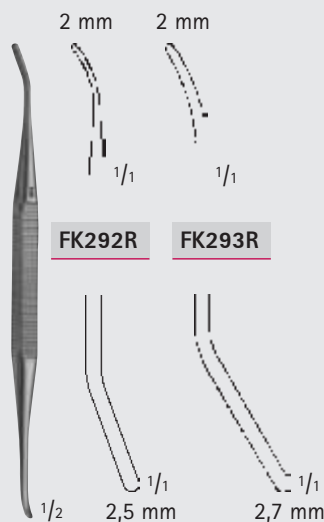

WATSON-CHEYNE

FK292R 130 mm 5 1/8"

FK293R 190 mm 7 1/2"



FREER

OL164R

180 mm, 7"



Knochenheber, Raspatorien, Scharfe Löffel – Bone Levers, Elevators, Bone Curettes

Raspatorien
Raspatories

FK

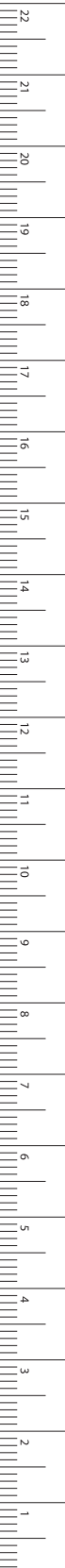
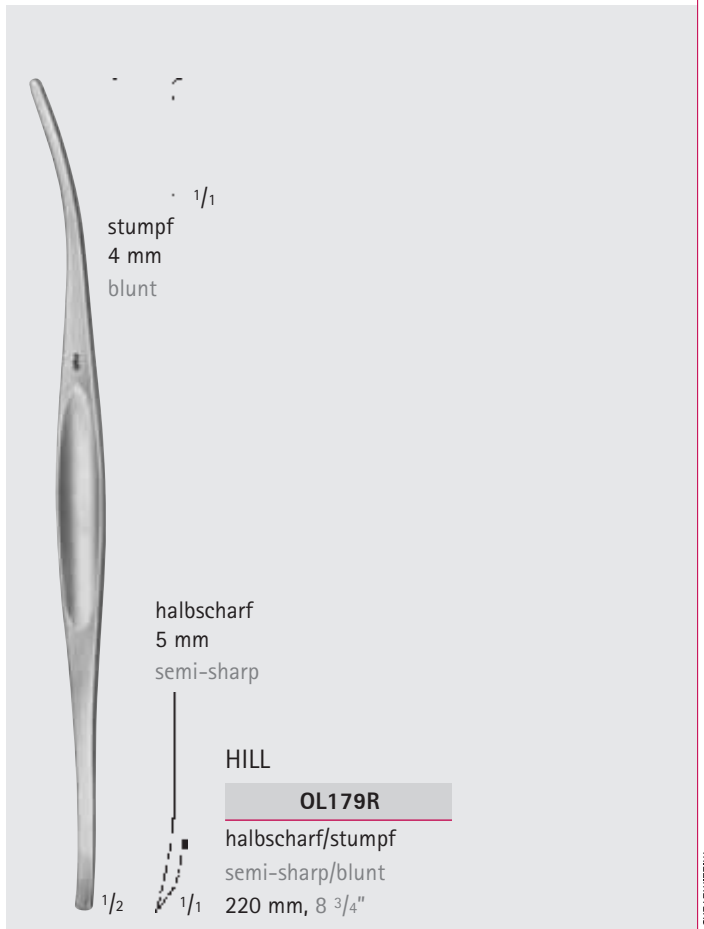
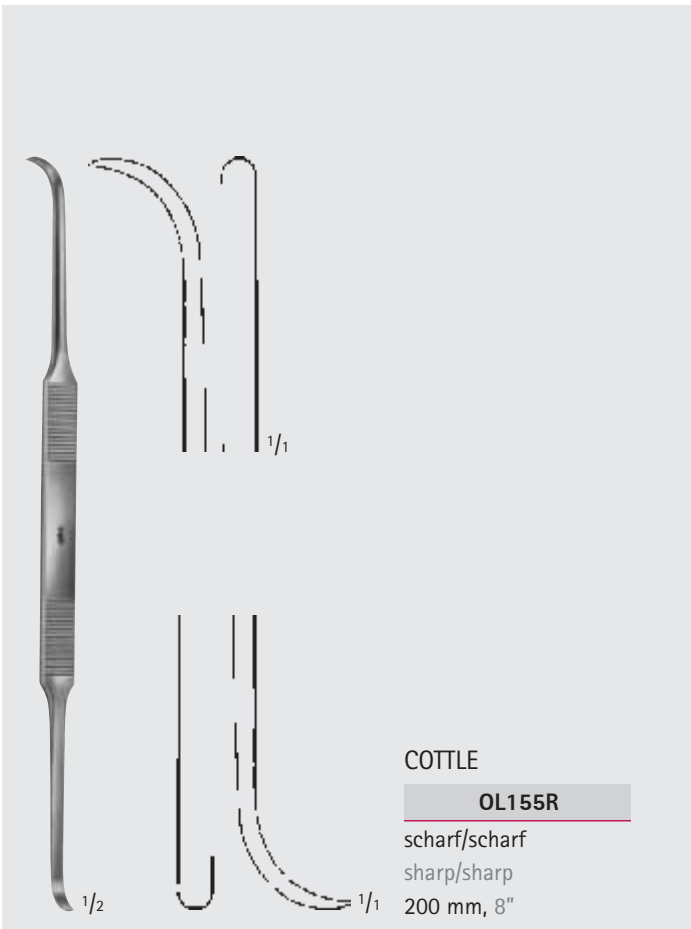
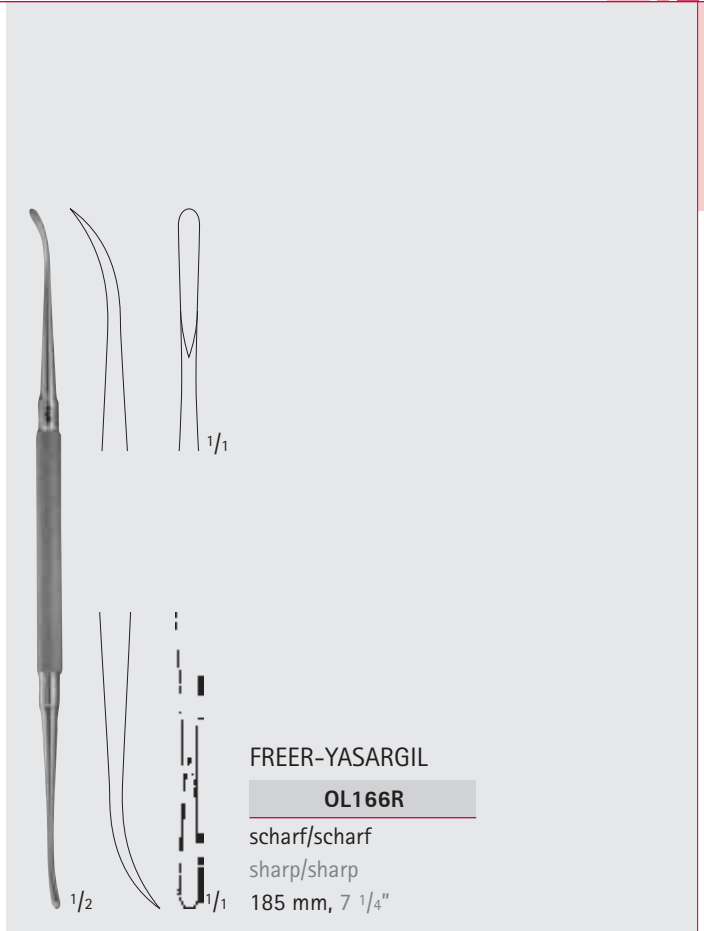
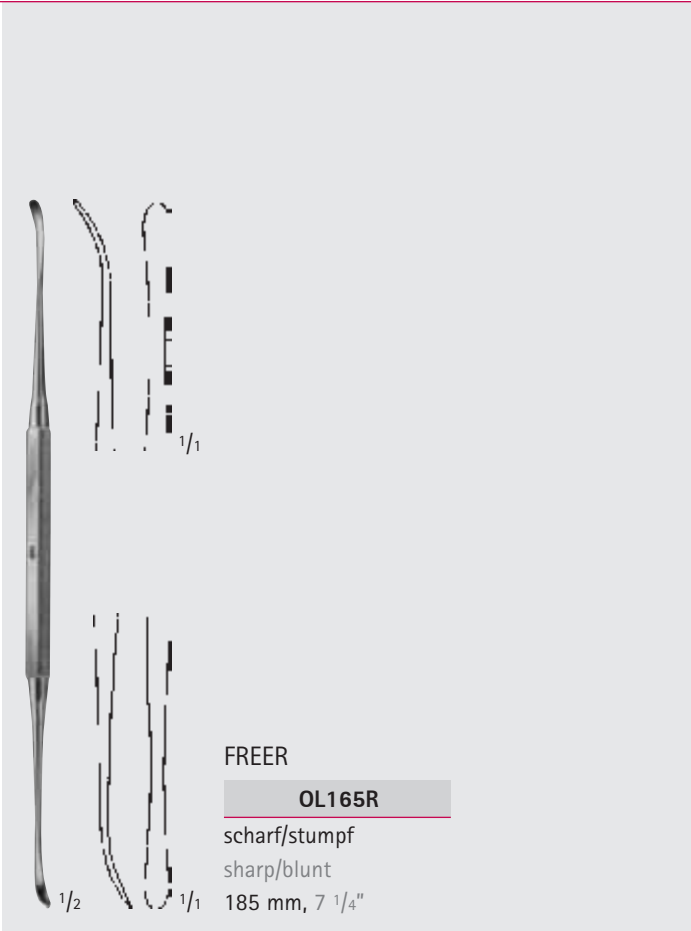

MILLIMETERS

Knochenheber, Raspatorien, Scharfe Löffel – Bone Levers, Elevators, Bone Curettes

Raspatorien

Raspatories

FK



MEAD

DO520R

scharf/scharf
sharp/sharp
165 mm, 6 1/4"



MOLT

DO543R

scharf/scharf
sharp/sharp
180 mm, 7"



SYME

DO547R

scharf
sharp
185 mm, 7 1/4"

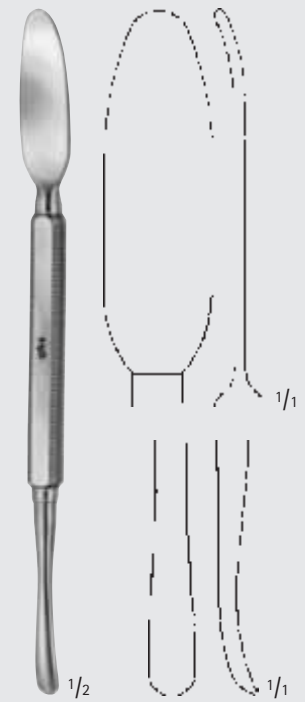

ROBERTS

DO548R

stumpf
blunt
185 mm, 7 1/4"

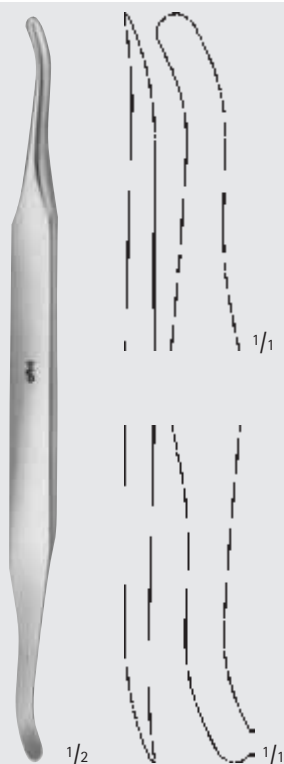

SELDIN

DO552R

195 mm, 7 3/4"



SELDIN

DO553R

195 mm, 7 3/4"



Knochenheber, Raspatorien, Scharfe Löffel – Bone Levers, Elevators, Bone Curettes

Raspatorien
Raspatories

FK



FK530R

4 mm

FK532R

7 mm

FK534R

9 mm



FK541R

3 mm

FK542R

6 mm

FK543R

6 mm



FK552R

8 mm



FK562R

6 mm

90°



1/2

MANNERFELT, MODIF.

FK530R-FK562R

155 mm, 6"

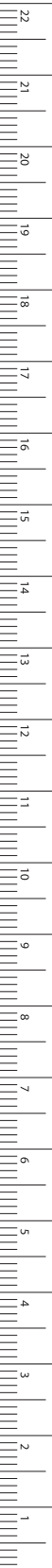

MILLIMETERS

Knochenheber, Raspatorien, Scharfe Löffel – Bone Levers, Elevators, Bone Curettes

Raspatorien
Raspatories

FK

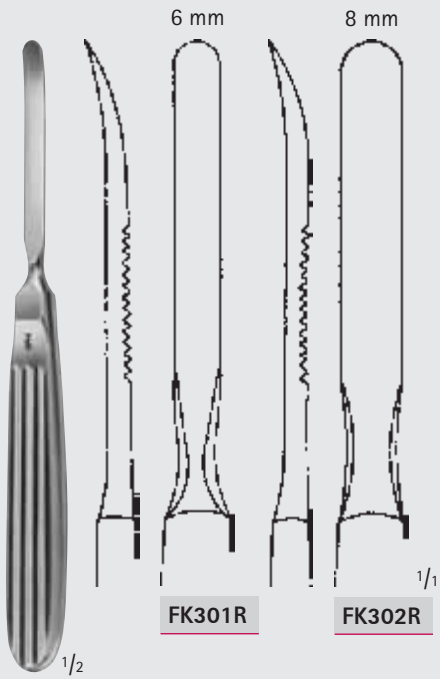

FK301R

FK302R

FK301R-FK302R

165 mm, 6 1/2"

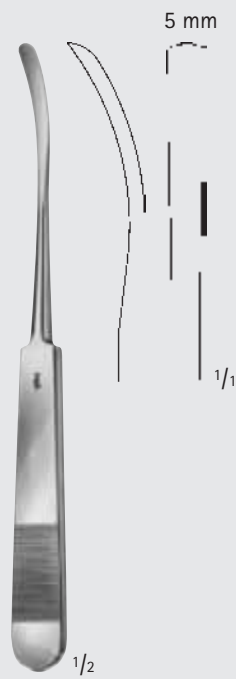

ADSON

FK299R

165 mm, 6 1/2"

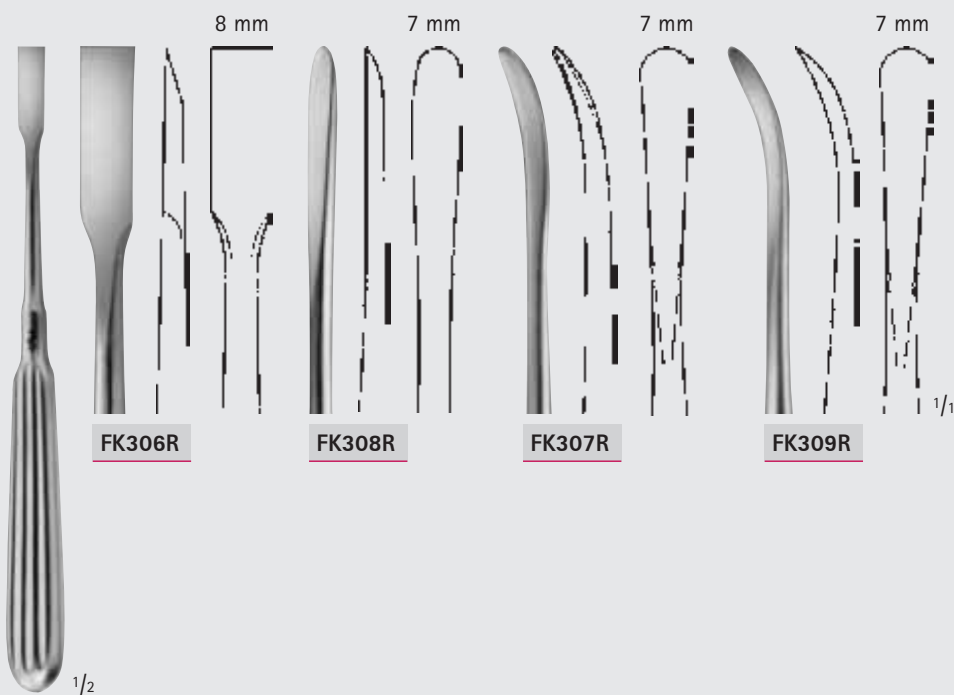

FK306R

FK308R

FK307R

FK309R

ADSON

FK306R-FK309R

170 mm, 6 3/4"



Knochenheber, Raspatorien, Scharfe Löffel – Bone Levers, Elevators, Bone Curettes

Raspatorien
Raspatories

FK

4 mm

4 mm

4 mm

4 mm

FK394R

FK395R

FK396R

FK397R

1/2

MÜHLING

FK394R-FK397R

170 mm, 6 3/4"

8 mm

1/1

1/2

COTTLE

OL157R

195 mm, 7 3/4"

4,7 mm

1/1

1/2

LANDOLT

FK314R

175 mm, 7"

6,2 mm

1/1

1/2

CASPAR

FK328R

180 mm, 7"

6,2 mm

1/1

1/2

CASPAR

FK329R

180 mm, 7"

6 mm

1/1

1/2

D0523R

170 mm, 6 3/4"



Knochenheber, Raspatorien, Scharfe Löffel – Bone Levers, Elevators, Bone Curettes

Raspatorien mit PEEK-Griff

Raspatories with PEEK-Handle

Dampfsterilisierbar bis 143°C (3 bar)

Can be sterilized in a steam sterilizer up to 143°C (3 bar)

FK

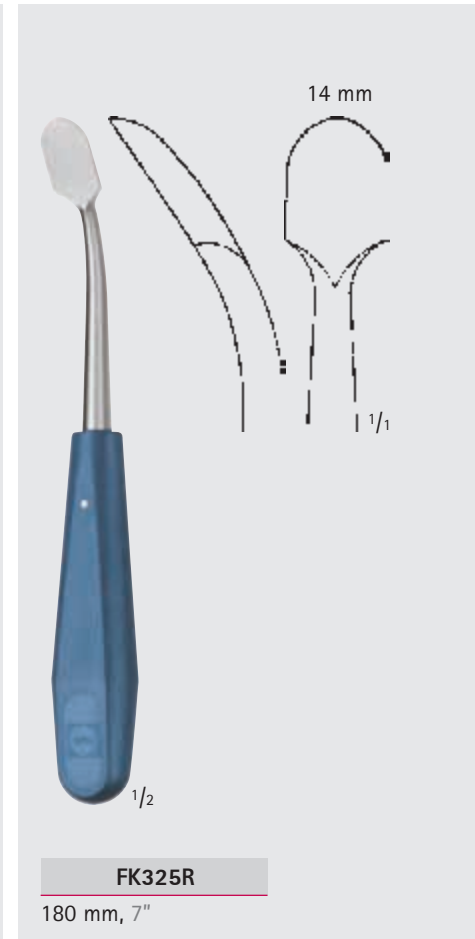
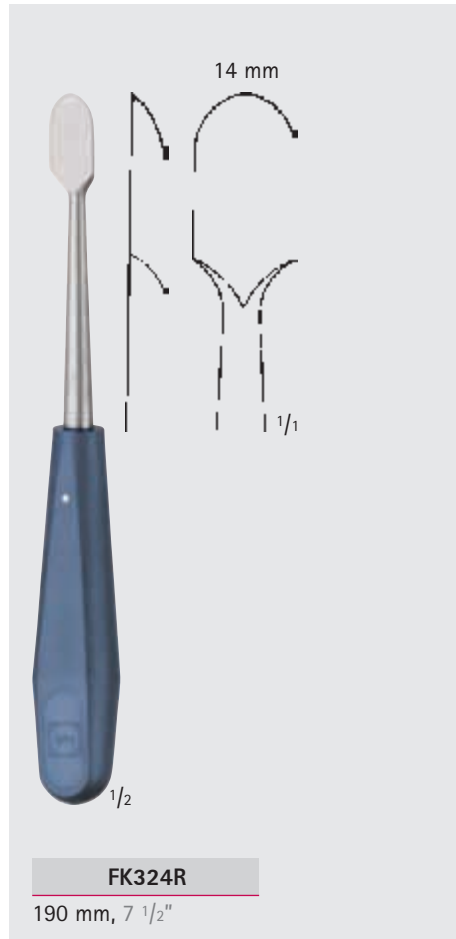
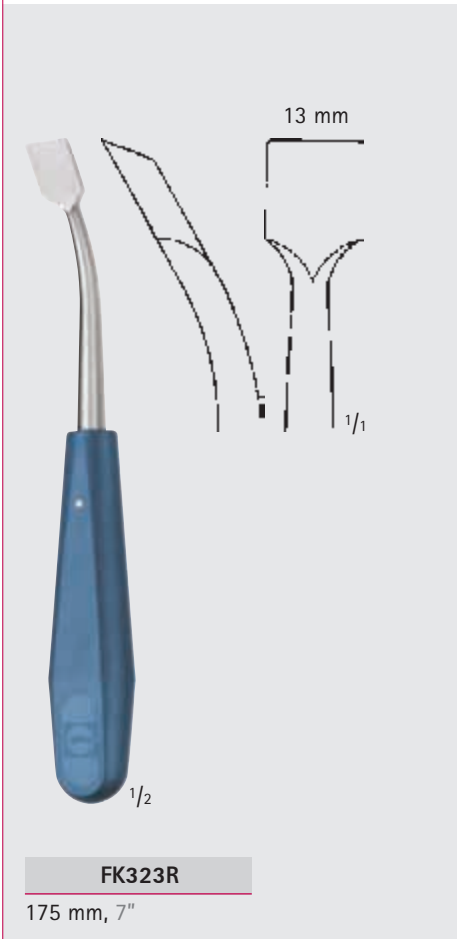



Knochenheber, Raspatorien, Scharfe Löffel – Bone Levers, Elevators, Bone Curettes

Raspatorien
Raspatories

FK

17 mm

1/2

1/1

LANGENBECK

MB279R

190 mm, 7 1/2"

12,5 mm

1/2

1/1

FARABEUF

FK340R

140 mm, 5 1/2"

12,5 mm

1/2

1/1

FARABEUF

FK341R

140 mm, 5 1/2"

11 mm

1/2

1/1

FARABEUF-COLLIN

FK344R

160 mm, 6 1/4"

11 mm

1/2

1/1

FARABEUF-COLLIN

FK345R

160 mm, 6 1/4"

18 mm

1/2

1/1

SEDILLOT

FK350R

185 mm, 7 1/4"

11 mm

stumpf
blunt

1/2

1/1

MC KISSOCK

FK379R

195 mm, 7 3/4"

10 mm

1/2

1/1

KRÄMER

FK390R

185 mm, 7 1/4"



Knochenheber, Raspatorien, Scharfe Löffel – Bone Levers, Elevators, Bone Curettes

Raspatorien
Raspatories

FK

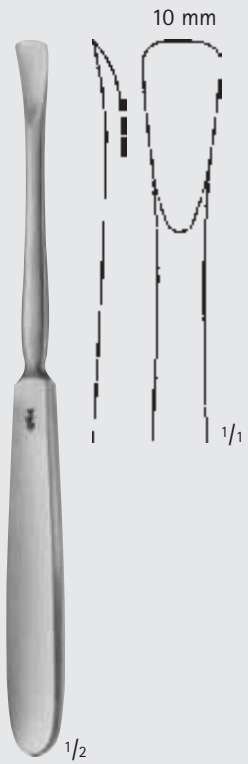
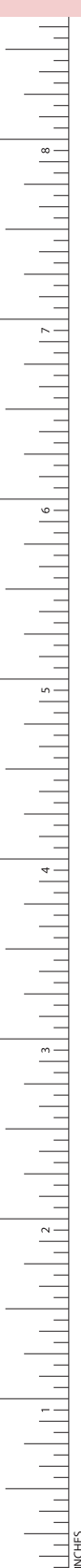

KRÄMER

FK391R

190 mm, 7 1/2"

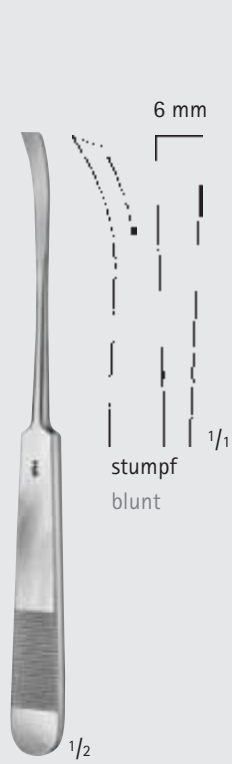

PENNYBAKER

FK378R

165 mm, 6 1/2"

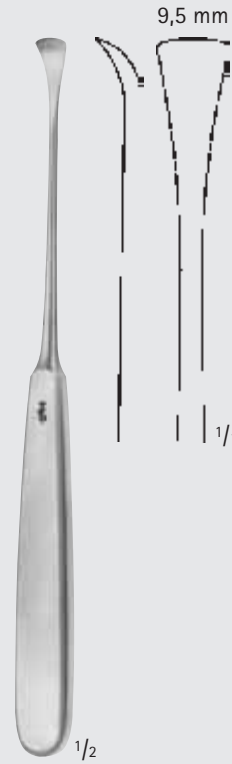

BÜCHS

D0518R

190 mm, 7 1/2"

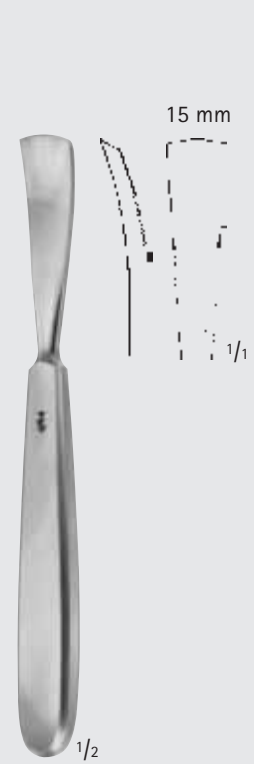

JANSEN

FK362R

165 mm, 6 1/2"

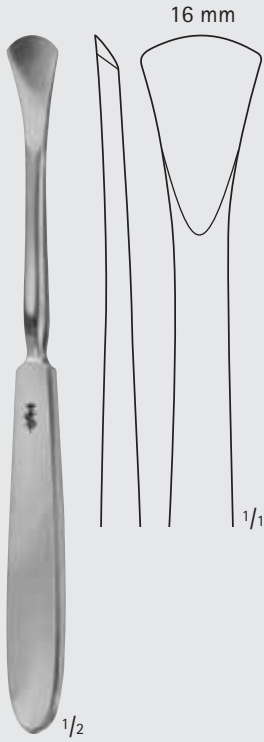

LANGENBECK

FK360R

190 mm, 7 1/2"

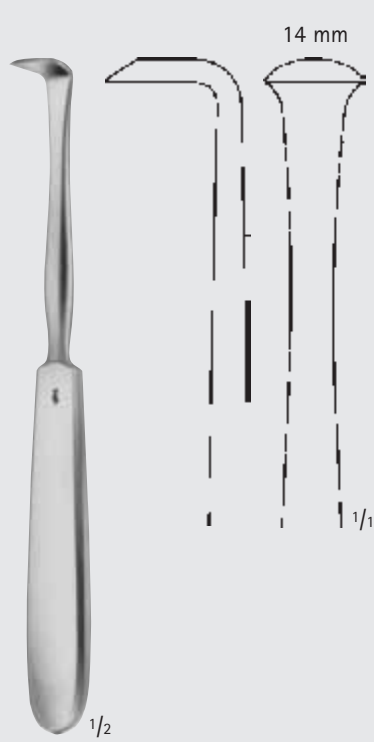

LANGENBECK

FK361R

180 mm, 7"



KEY

FK410R-FK414R

	Breite Width	Länge Length	
FK410R	6 mm	180 mm	7"
FK411R	10 mm	190 mm	7 1/2"
FK412R	13 mm	190 mm	7 1/2"
FK413R	19 mm	200 mm	8"
FK414R	25 mm	210 mm	8 1/4"



Knochenheber, Raspatorien, Scharfe Löffel – Bone Levers, Elevators, Bone Curettes

Raspatorien
Raspatories

FK

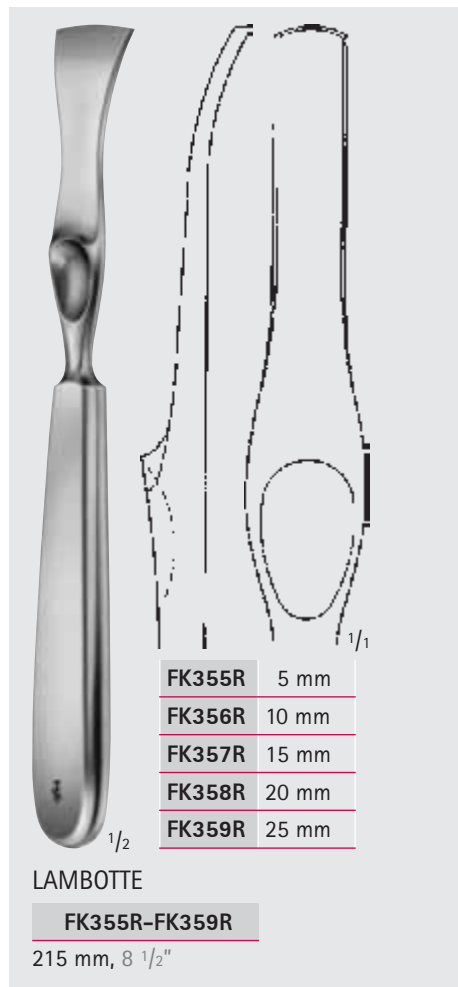
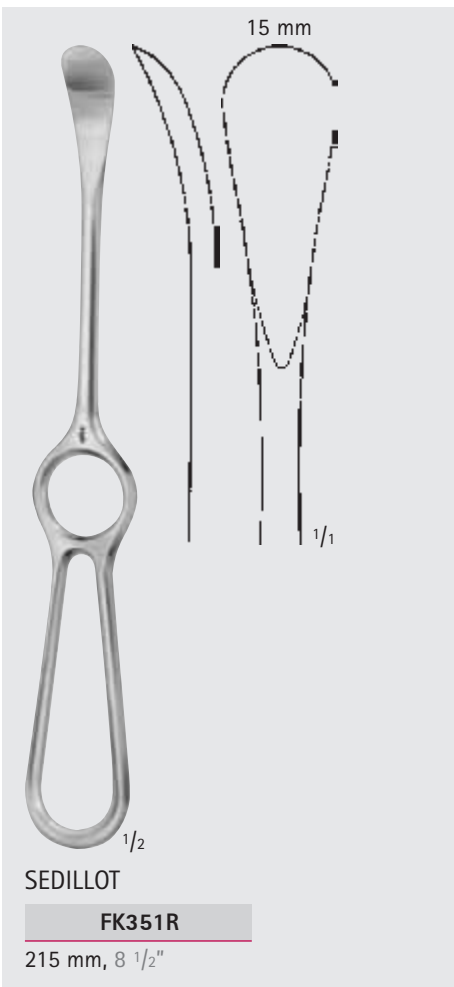
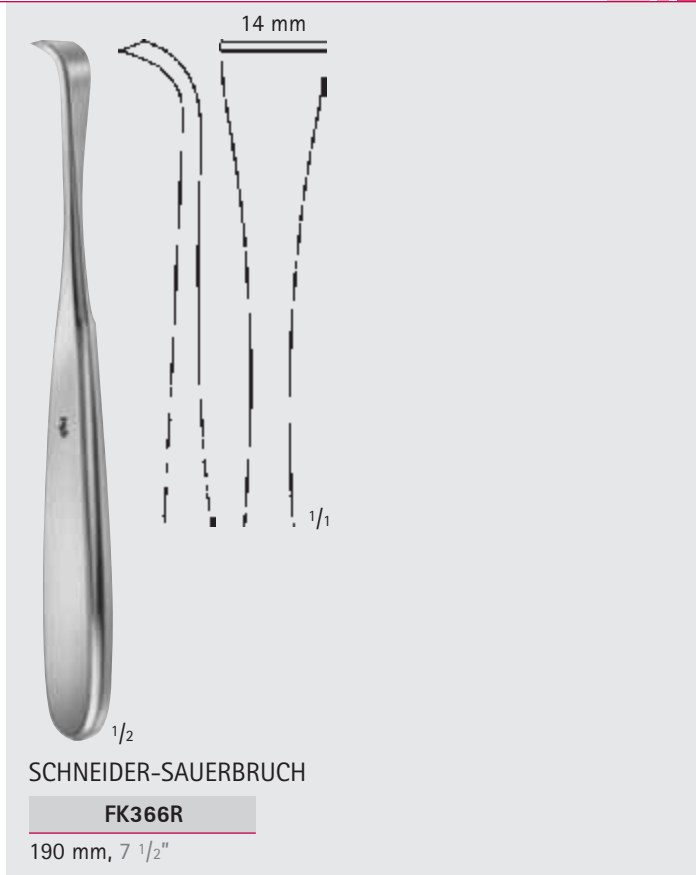
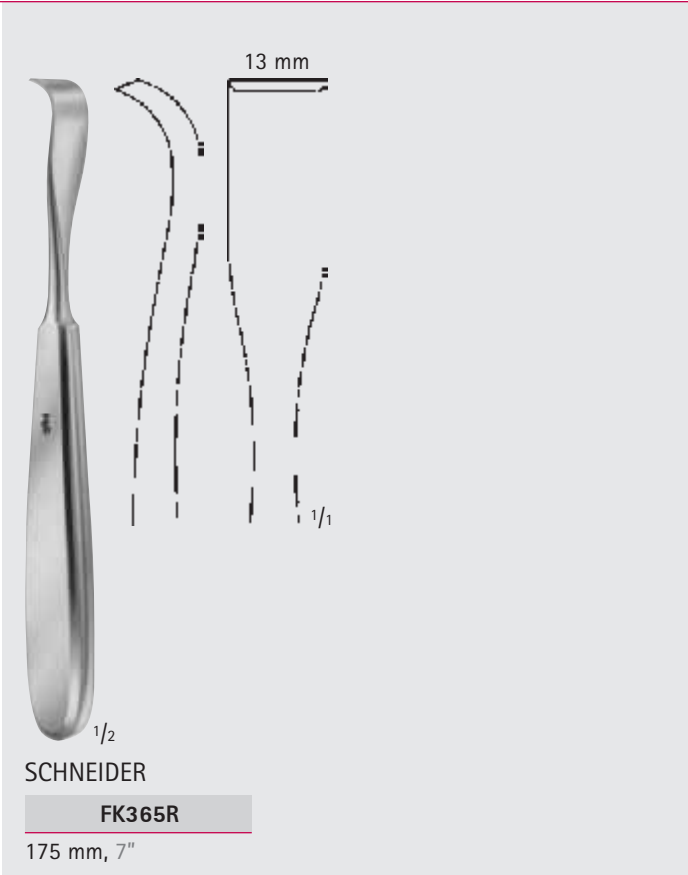

MILLIMETERS

Knochenheber, Raspatorien, Scharfe Löffel – Bone Levers, Elevators, Bone Curettes

Raspatorien

Raspatories

FK



FK146R

FK147R

FK148R

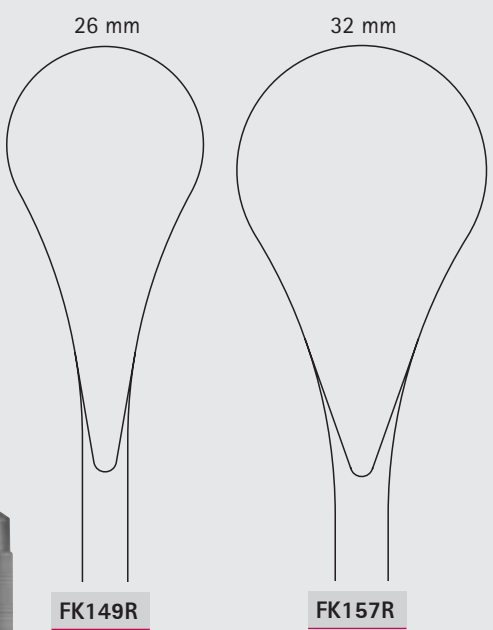

FK149R

FK157R



1/2

COBB
FK146R-FK157R

280 mm, 11"

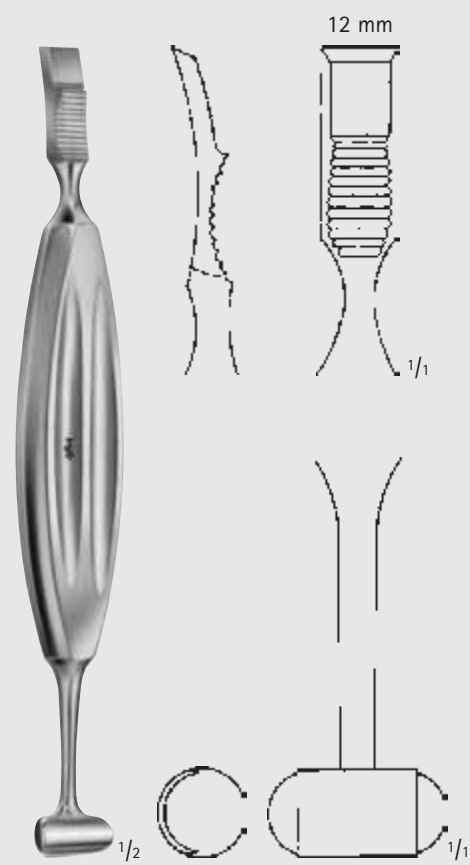

1/2

ALEXANDER
FK420R

210 mm, 8 1/4"





Knochenheber, Raspatorien, Scharfe Löffel – Bone Levers, Elevators, Bone Curettes

Raspatorien
Raspatories

FK

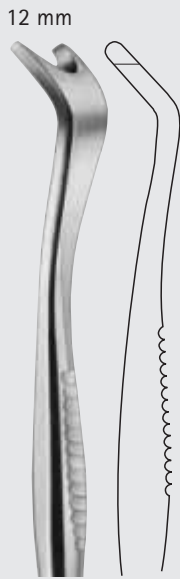
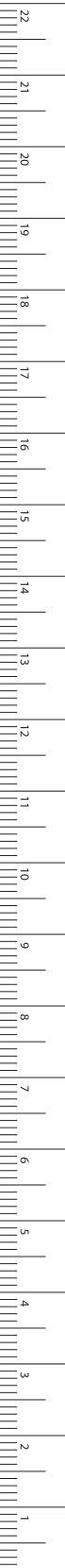

FK381R
190 mm
7 1/2"

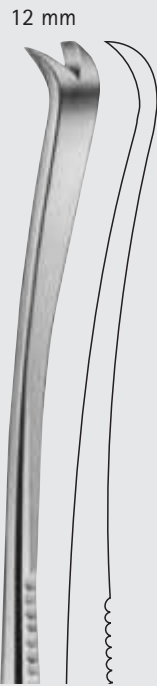

FK382R
230 mm
9"



FK383R
230 mm
9"



FK384R
230 mm
9"



FK387R
230 mm
9"

SEMB

FK381R-FK387R

Knochenheber, Raspatorien, Scharfe Löffel – Bone Levers, Elevators, Bone Curettes

Raspatorien
Raspatories

FK

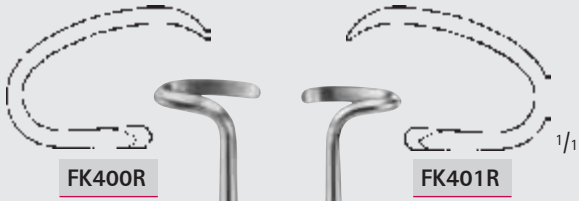

FK400R

FK401R



DOYEN

FK400R-FK401R

für Kinder
for children

1/2 175 mm, 7"



FK402R

FK403R



DOYEN

FK402R-FK403R

für Erwachsene
for adults

1/2 175 mm, 7"



FK408R

FK409R



DOYEN

FK408R-FK409R

1/2 240 mm, 9 1/2"



Knochenheber, Raspatorien, Scharfe Löffel – Bone Levers, Elevators, Bone Curettes

Raspatorien mit PEEK-Griff
Raspatories with PEEK Handle

Dampfsterilisierbar bis 143°C

Can be sterilized in a steam sterilizer up to 143°C (3 bar)

FK

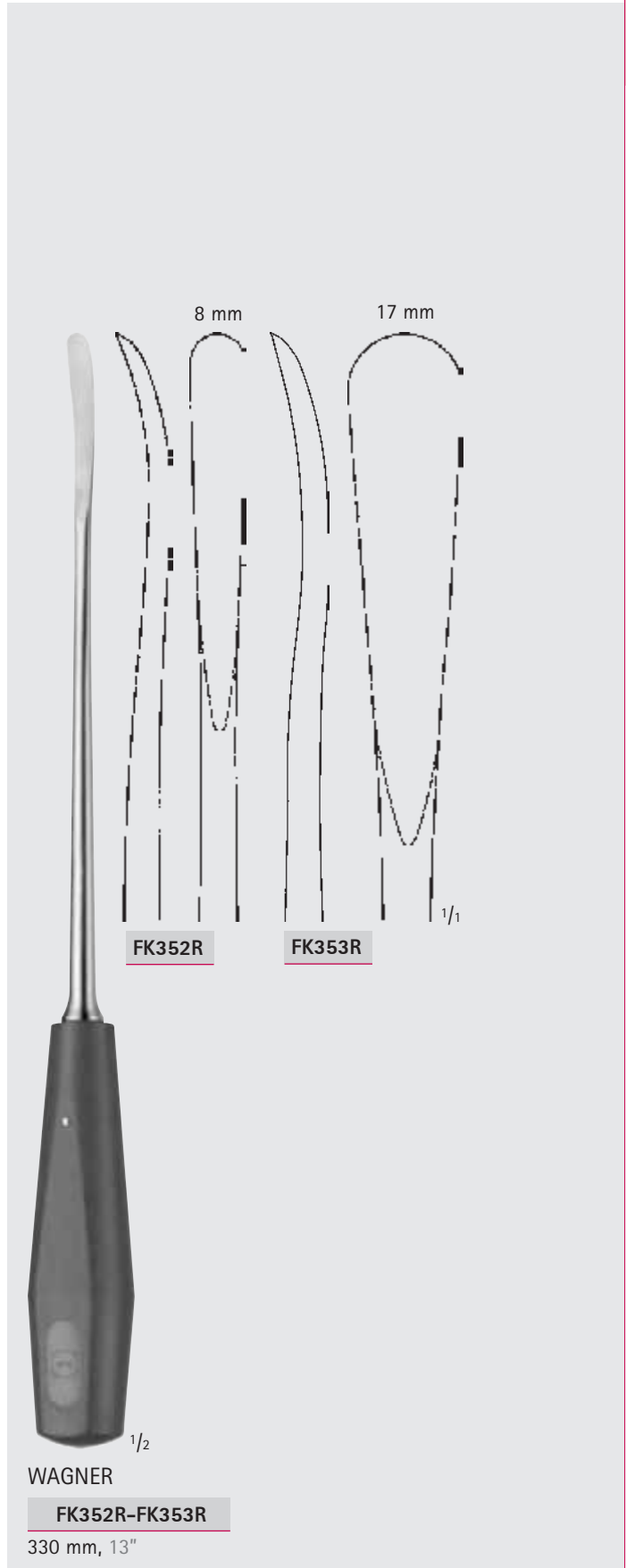
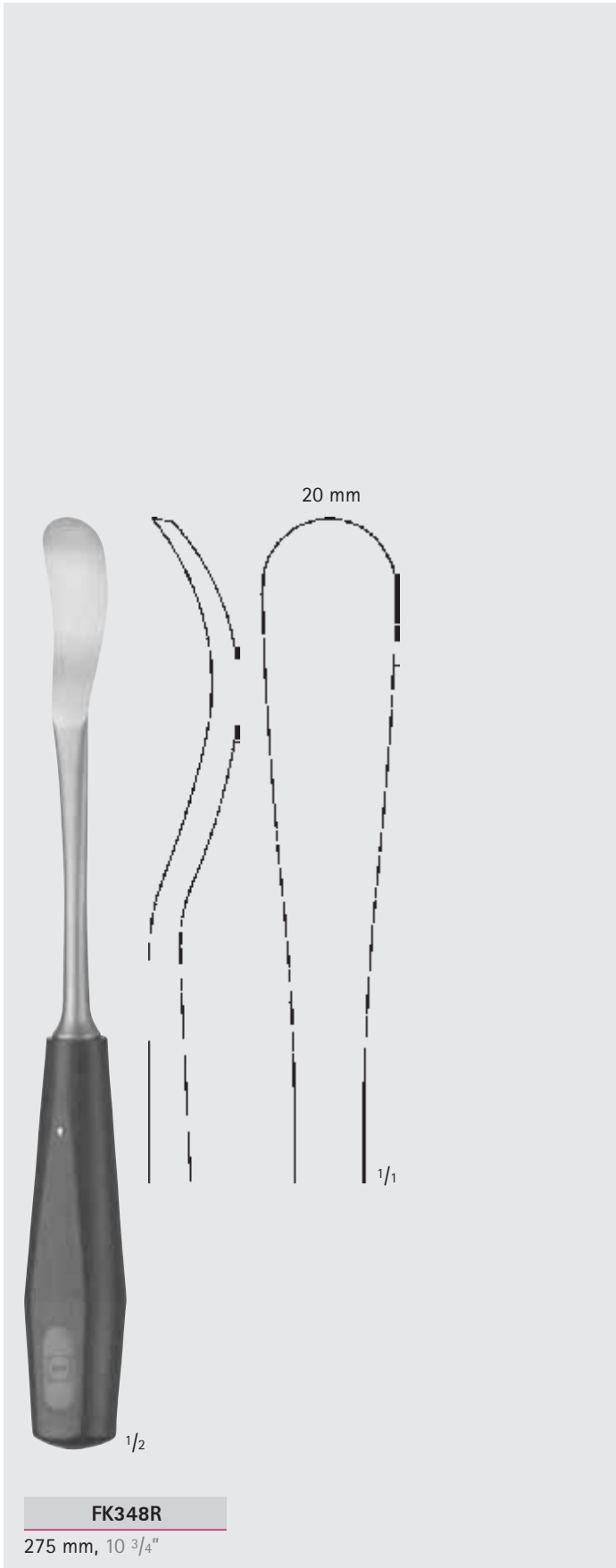

MILLIMETERS

Knochenheber, Raspatorien, Scharfe Löffel – Bone Levers, Elevators, Bone Curettes

Knochen-Feilen und -Raspeln

Bone Files and Rasps

FK



7,5 mm 9 mm

OL401R
kariert, fein
fine, chequered

OL403R
kariert, grob
coarse, chequered

JOSEPH
OL401R-OL403R
165 mm, 6 1/2"

1/2

8 mm 8 mm

OL408R
feine Zahnung
fine teeth

OL409R
grobe Zahnung
coarse teeth

LEWIS
OL408R-OL409R
175 mm, 7"

1/2

9 mm

MALTZ
OL407R
auf Zug
down stroke
180 mm, 7"

1/2

9 mm 9 mm

OL410R
auf Druck
up stroke

OL411R
auf Zug
down stroke

AUFRICHT
OL410R-OL411R
220 mm, 8 3/4"

1/2

6,5 mm

GALLAHER
OL412R
190 mm, 7 1/2"

1/2



Knochenheber, Raspatorien, Scharfe Löffel – Bone Levers, Elevators, Bone Curettes

Knochen-Feilen und -Raspeln, DUROGRIP® Raspeln

Bone Files and Rasps, DUROGRIP® Rasps

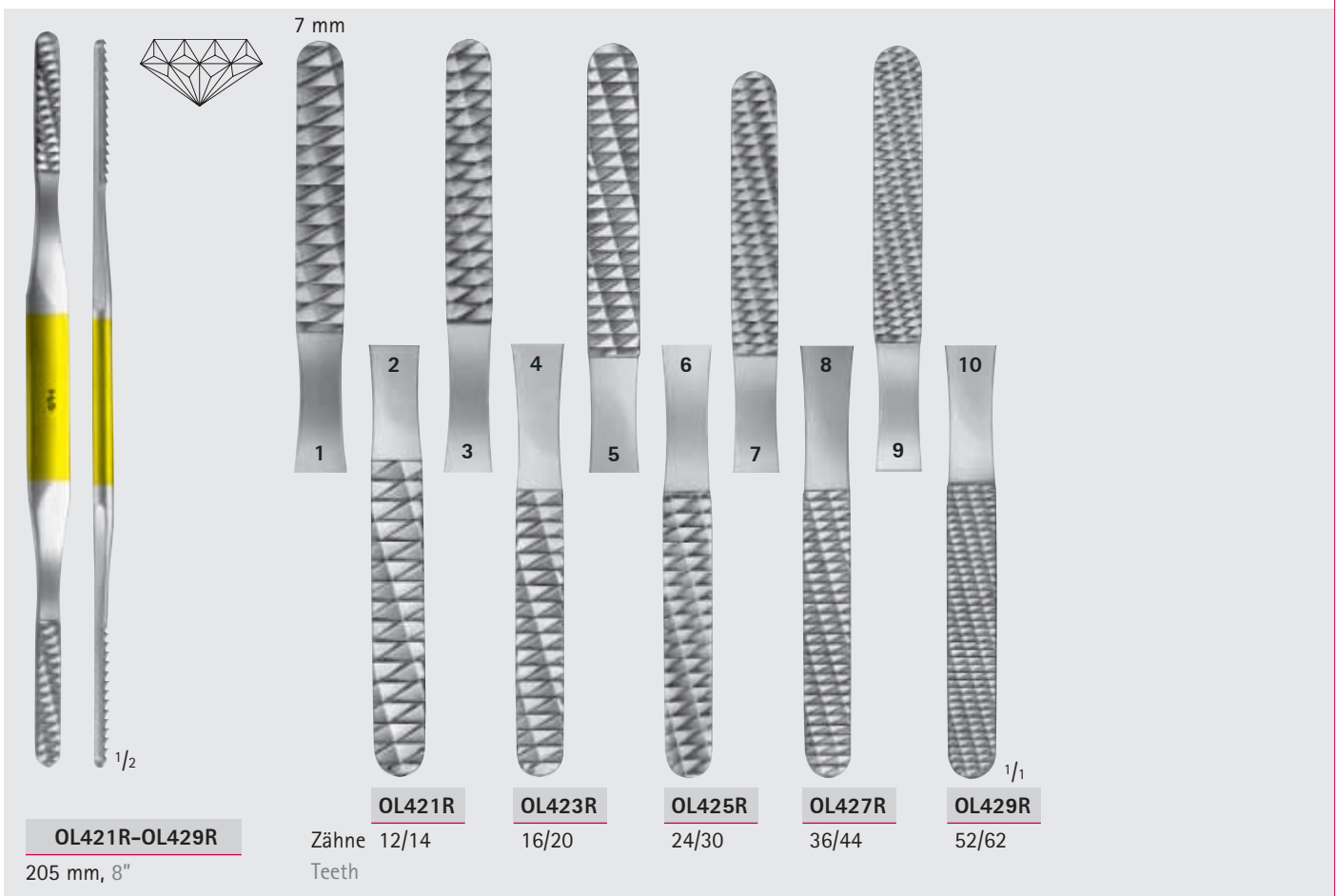
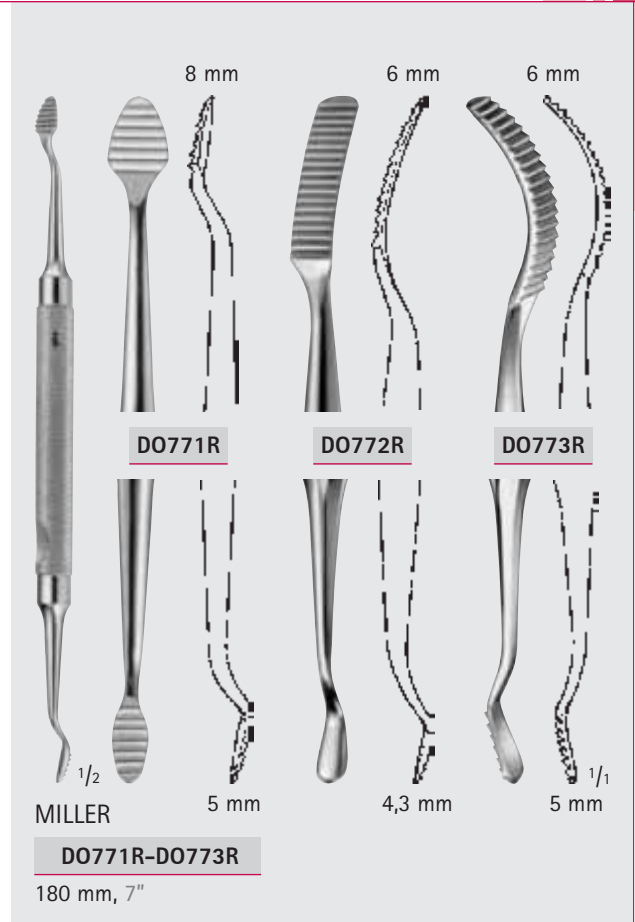
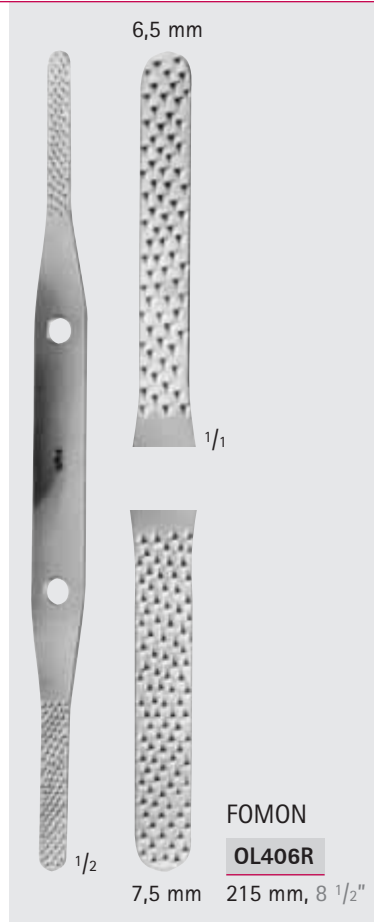
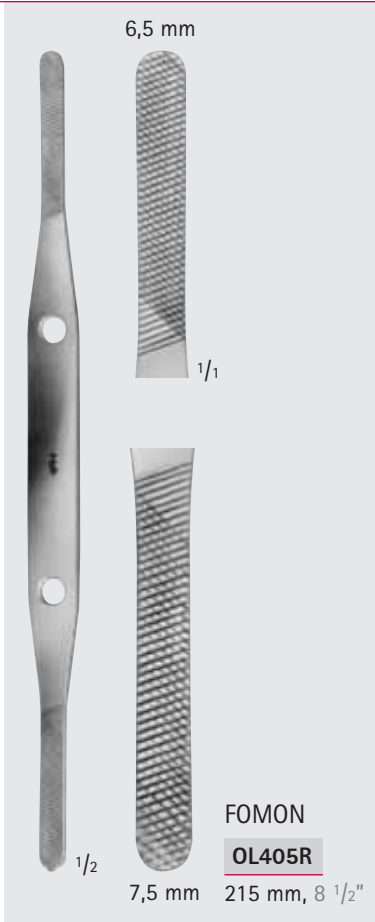

FK

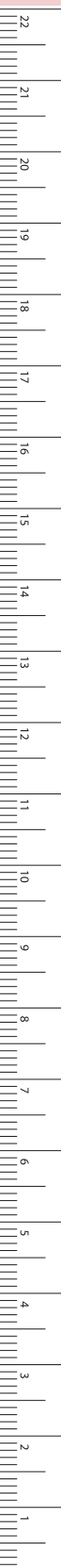

MILLIMETERS

Knochenheber, Raspatorien, Scharfe Löffel – Bone Levers, Elevators, Bone Curettes

Knochen-Feilen und -Raspeln

Bone Files and Rasps

FK



20 mm



eine Seite Feilenhieb,
andere Seite Raspelhieb
one side file cut one
side rasp cut

1/2

FK507R

220 mm, 8 3/4"

20 mm



1/2

FK510R

295 mm, 11 3/4"

13 mm

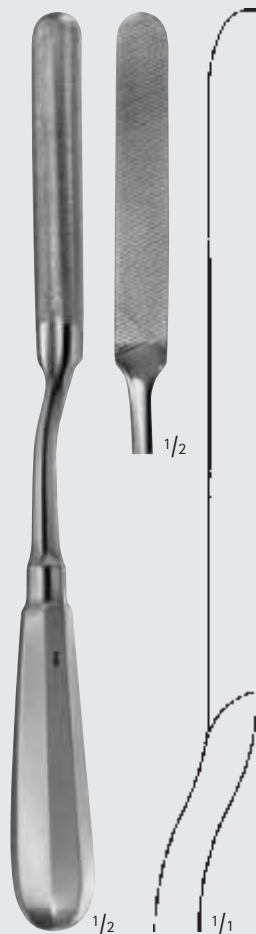

1/2

1/1

FK511R

240 mm, 9 1/2"

18 mm



1/2

1/1

20 mm

PUTTI

FK505R

270 mm, 10 3/4"



Knochenheber, Raspatorien, Scharfe Löffel – Bone Levers, Elevators, Bone Curettes

Scharfe Löffel
Bone Curettes

FK



JACOBSON

FK813R

140 mm, 5 1/2"



MARTINI

FK800R

140 mm, 5 1/2"

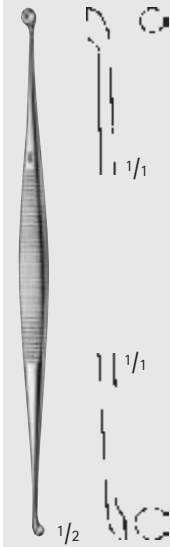

MARTINI

FK801R

140 mm, 5 1/2"



WILLIGER

FK814R

145 mm, 5 3/4"



JANSEN

FK803R

160 mm, 6 1/4"



BARTH

FK817R

180 mm, 7"



FK850R

210 mm, 8 1/4"

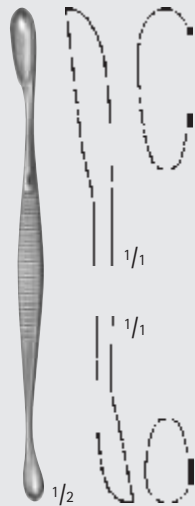

VOLKMANN

FK840R

130 mm, 5 1/8"

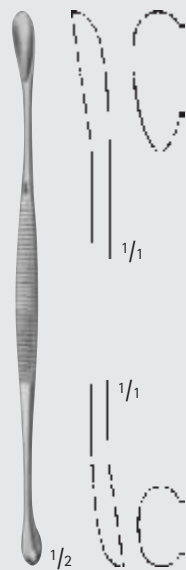

VOLKMANN

FK841R

145 mm, 5 3/4"



VOLKMANN

FK842R

170 mm, 6 3/4"

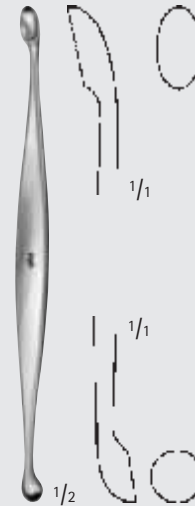

FK845R

130 mm, 5 1/8"

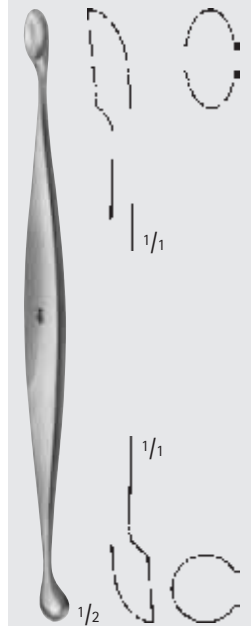

FK846R

160 mm, 6 1/4"

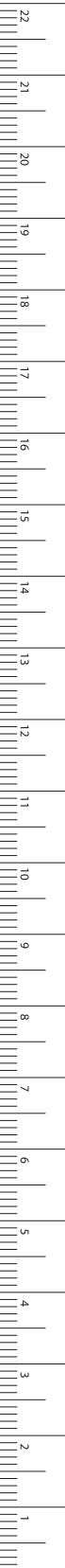

MILLIMETERS

Knochenheber, Raspatorien, Scharfe Löffel – Bone Levers, Elevators, Bone Curettes

Scharfe Löffel

Bone Curettes

FK

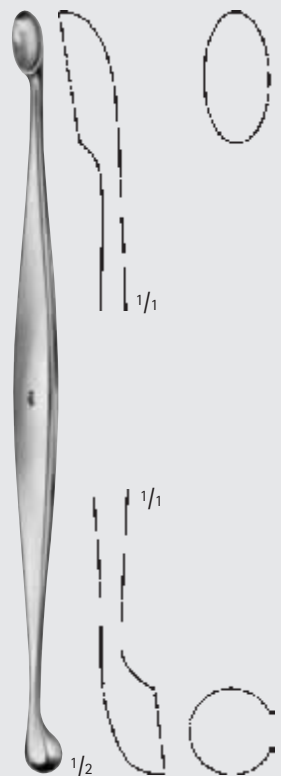

FK848R

200 mm, 8"



DO650R

160 mm, 6 1/4"



JANSEN

DO651R

160 mm, 6 1/4"

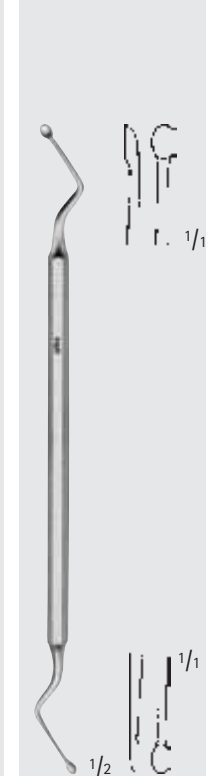

HEMINGWAY

DO655R

170 mm, 6 3/4"

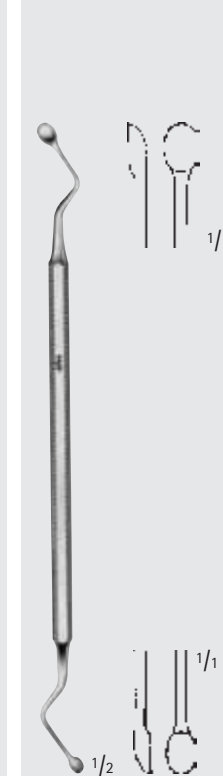

HEMINGWAY

DO656R

170 mm, 6 3/4"



HEMINGWAY

DO670R

Fig. 0
170 mm, 6 3/4"



HEMINGWAY

DO671R

Fig. 1
170 mm, 6 3/4"



HEMINGWAY

DO672R

Fig. 2
170 mm, 6 3/4"



HEMINGWAY

DO673R

Fig. 3
170 mm, 6 3/4"

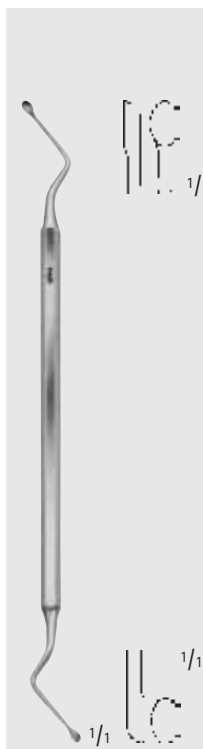

HEMINGWAY

DO674R

Fig. 4
170 mm, 6 3/4"

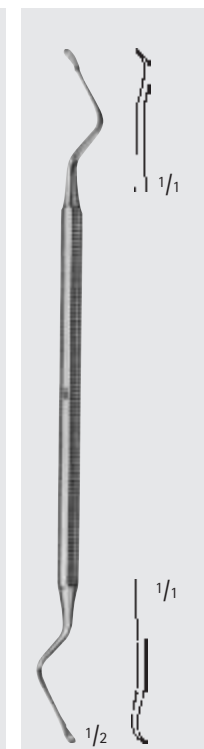

LUCAS

DO608R

180 mm, 7"

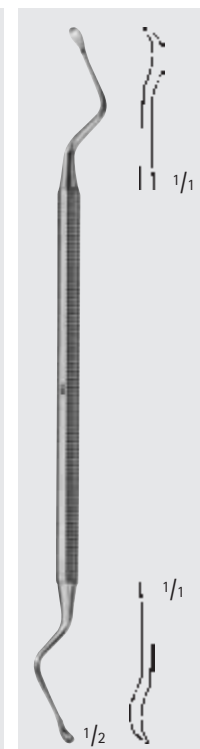

LUCAS

DO609R

185 mm, 7 1/4"



Knochenheber, Raspatorien, Scharfe Löffel – Bone Levers, Elevators, Bone Curettes

Scharfe Löffel
Bone Curettes

FK



DO630R



DO632R

1/2

KERPEL

DO630R-DO632R

145 mm, 5 3/4"



DO631R



DO633R

1/2

KERPEL

DO631R-DO633R

145 mm, 5 3/4"

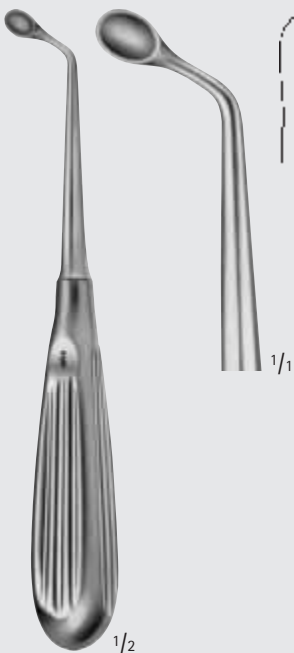

1/1

1/1

1/2

UFFENDORDE

FK660R

170 mm, 6 3/4"

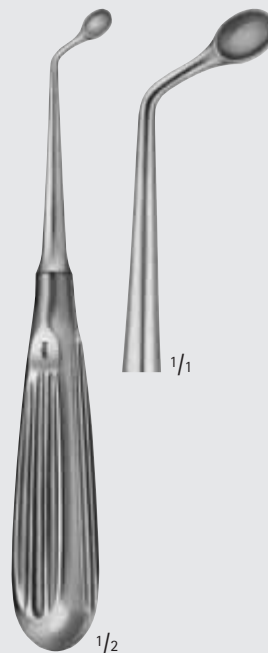

1/1

1/1

1/2

UFFENDORDE

FK661R

170 mm, 6 3/4"

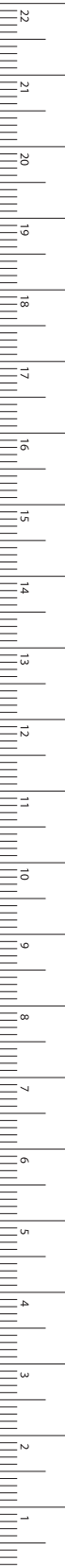

MILLIMETERS

Knochenhebel, Raspatorien, Scharfe Löffel – Bone Levers, Elevators, Bone Curettes

Scharfe Löffel

Bone Curettes

FK



BRUNS

FK611R-FK617R

165 mm, 6 1/2"

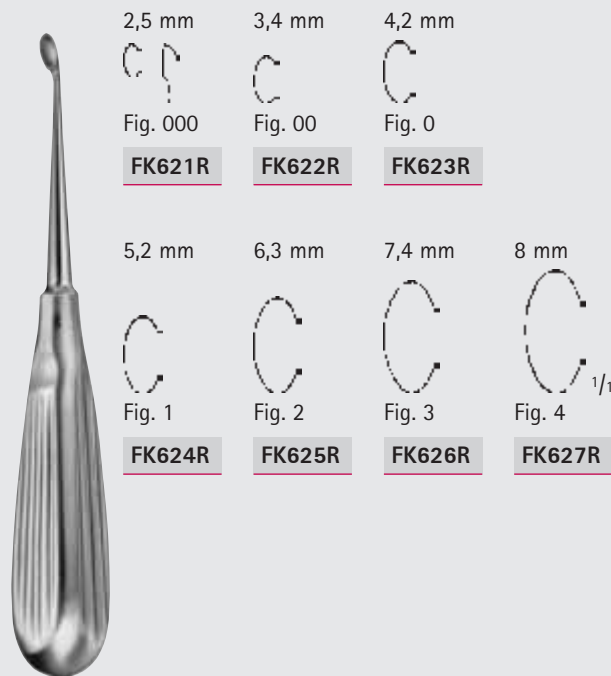
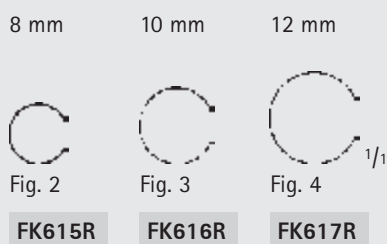
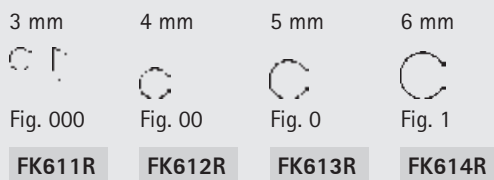

SCHEDE

FK621R-FK627R

170 mm, 6 3/4"

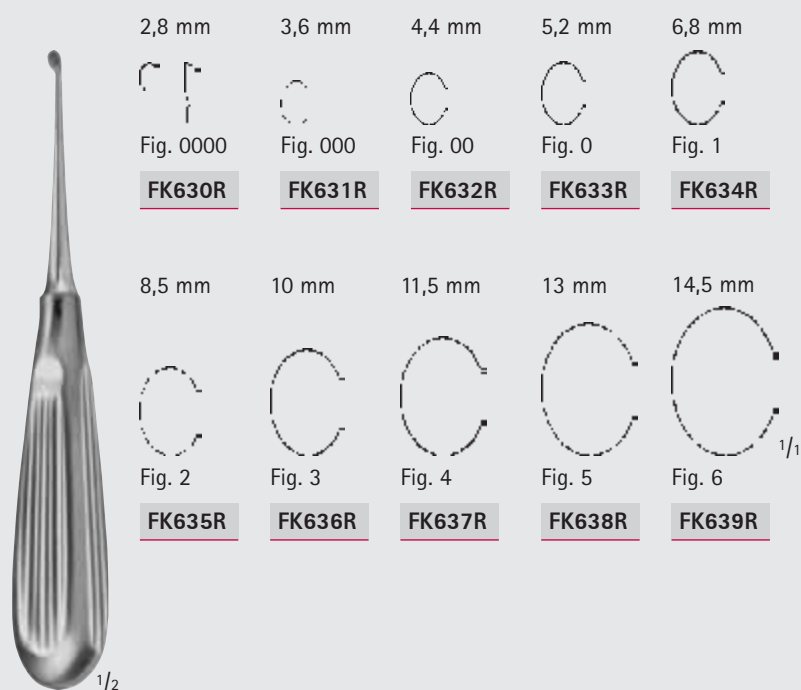
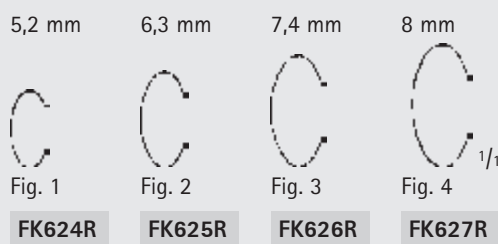
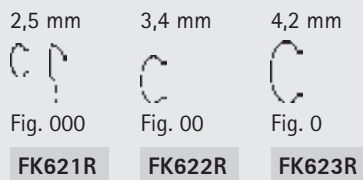

VOLKMANN

FK630R-FK639R

170 mm, 6 3/4"

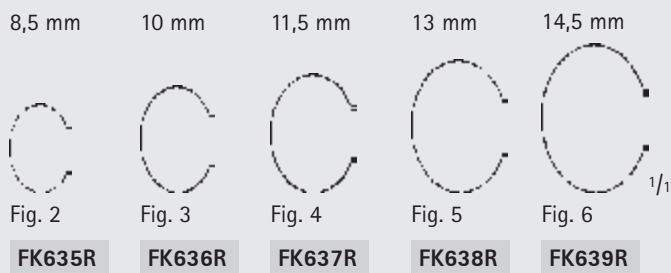
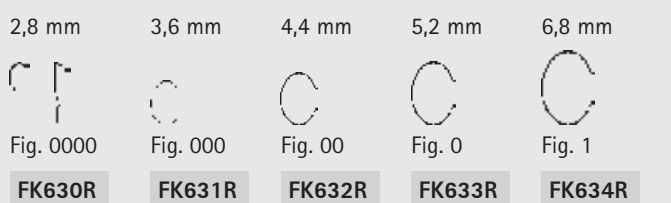

WILLIGER

FK658R-FK659R

170 mm, 6 3/4"

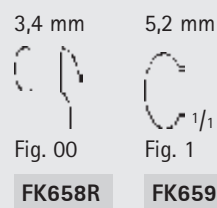

Knochenheber, Raspatorien, Scharfe Löffel – Bone Levers, Elevators, Bone Curettes

Scharfe Löffel
Bone Curettes

FK

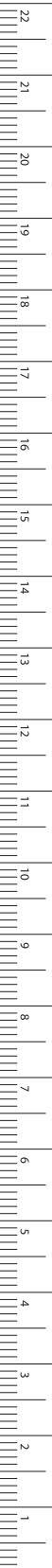

1,8 mm

FK675R

2,0 mm

FK676R

2,4 mm

FK677R

2,6 mm

FK678R

2,8 mm

FK679R

1/2

LEMPERT

FK675R-FK679R

215 mm, 8 1/2"



biegsam
malleable

4,4 mm

Fig. 00

FK684R

5,2 mm

Fig. 0

FK685R

6,8 mm

Fig. 1

FK686R

1/2

HALLE

FK684R-FK686R

215 mm, 8 1/2"



2,8 mm

Fig. 0000

FK662R

3,6 mm

Fig. 000

FK663R

4,4 mm

Fig. 00

FK664R

5,2 mm

Fig. 0

FK665R

1/2

DAUBENSPECK

FK662R-FK665R

200 mm, 8"

Knochenheber, Raspatorien, Scharfe Löffel – Bone Levers, Elevators, Bone Curettes

Scharfe Löffel
Bone Curettes

FK

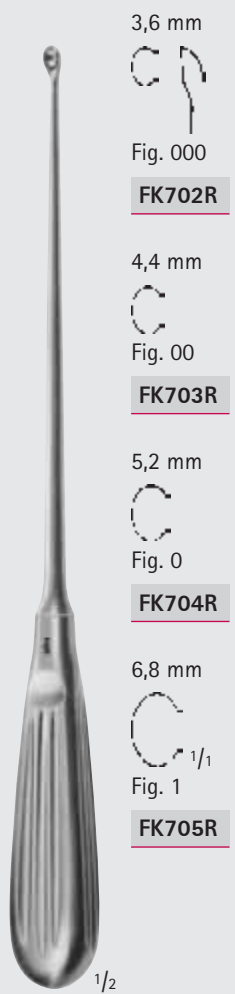

3,6 mm



Fig. 000

FK702R

4,4 mm



Fig. 00

FK703R

5,2 mm



Fig. 0

FK704R

6,8 mm



Fig. 1

FK705R

1/2

FK702R-FK705R

250 mm, 10"



3,6 mm



Fig. 000

FK712R

4,4 mm



Fig. 00

FK713R

5,2 mm



Fig. 0

FK714R

6,8 mm



Fig. 1

FK715R

1/2

FK712R-FK715R

250 mm, 10"



3 mm



Fig. 000

FK723R

4 mm



Fig. 00

FK724R

5 mm



Fig. 1

FK725R

1/2

BUSHE

FK723R-FK725R

250 mm, 10"



Knochenheber, Raspatorien, Scharfe Löffel – Bone Levers, Elevators, Bone Curettes

Scharfe Löffel
Bone Curettes

FK

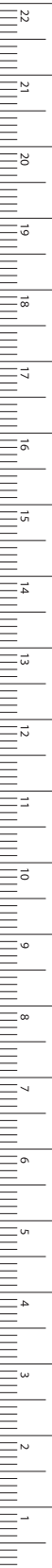

2,0 mm



Fig. 000

MB872R

2,5 mm



Fig. 00

MB873R

3,3 mm



Fig. 0

MB874R

3,8 mm



Fig. 1

MB875R

4,8 mm



Fig. 2

MB876R

5,3 mm



Fig. 3

MB877R

6,0 mm



Fig. 4

MB878R

6,7 mm



Fig. 5

MB879R

7,3 mm



Fig. 6

MB880R

¹/₂

BRUNS

MB872R-MB880R

230 mm, 9"

MILLIMETERS

Knochenheber, Raspatorien, Scharfe Löffel – Bone Levers, Elevators, Bone Curettes

Scharfe Löffel Bone Curettes

FK

3,6 mm



Fig. 000

FK688R

4,4 mm



Fig. 00

FK689R

5,2 mm



Fig. 0

FK690R

SIMON

FK688R-FK690R

1/2 235 mm, 9 1/4"

6,8 mm



Fig. 1

ER101R

8,5 mm



Fig. 2

ER102R

10 mm



Fig. 3

ER103R

11,5 mm



Fig. 4

ER104R

13 mm



Fig. 5

ER105R

14,5 mm



Fig. 6

ER106R

SIMON

ER101R-ER106R

1/2 max. 240 mm, 9 1/2"

3,6 mm



Fig. 000

FK773R

4,4 mm



Fig. 00

FK774R

5,2 mm



Fig. 0

FK775R

CASPAR

FK773R-FK775R

220 mm, 8 3/4"

1/2

3,6 mm



Fig. 000

FK783R

4,4 mm



Fig. 00

FK784R

5,2 mm



Fig. 0

FK785R

CASPAR

FK783R-FK785R

220 mm, 8 3/4"

1/2



4 mm

FK834R



5 mm

FK835R



6 mm

FK836R

CASPAR

FK834R-FK836R

gezahnt
toothed

1/2 220 mm, 8 3/4"





Knochenheber, Raspatorien, Scharfe Löffel – Bone Levers, Elevators, Bone Curettes

Scharfe Löffel
Bone Curettes

Dampfsterilisierbar bis 143°C (3 bar)
Can be sterilized in a steam sterilizer
up to 143°C (3 bar overpressure)

FK

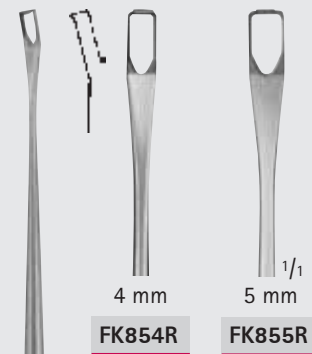
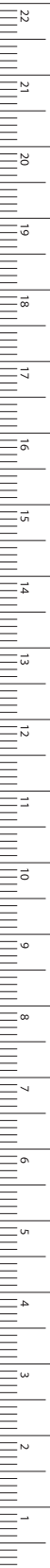

FK854R

FK855R

1/2

CASPAR

FK854R-FK855R

gezahnt
toothed
250 mm, 10"

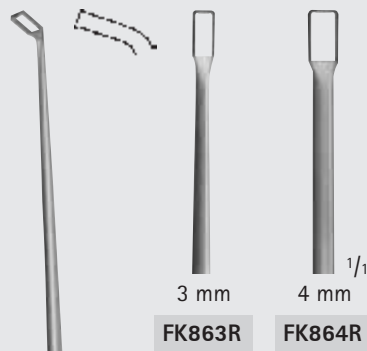

FK863R

FK864R

1/2

CASPAR

FK863R-FK864R

gezahnt
toothed
270 mm, 10 3/4"



4,4 mm

Fig. 00

FK666R

6,8 mm

Fig. 1

FK668R

8,5 mm

Fig. 2

FK670R

10 mm

Fig. 3

FK672R

1/2

FK666R-FK672R

270 mm, 10 3/4"

MILLIMETERS



INCHES

FL



Hämmer, Meißel
Mallets, Chisels and Gouges

Hämmer und Meißel – Mallets, Chisels and Gouges

Hämmer

Mallets

Die Gewichtsangaben beziehen sich auf den Kopf des jeweiligen Hammers

Weights refer to the heads of the mallets



Ø 20 mm
diam. 20 mm

MEAD

FL035R 180 g

mit auswechselbaren
Kunststoffbacken
with interchangeable
plastic discs

190 mm, 7 1/2"

FL034

Ersatzbackenpaar
Pair of spare discs

1/2

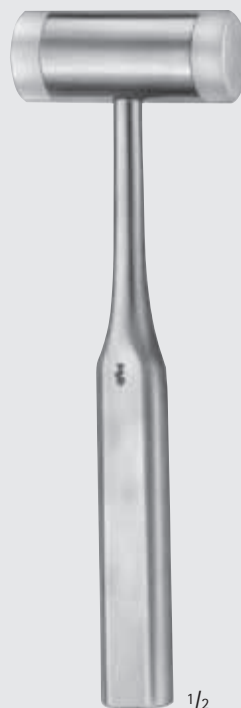

Ø 25 mm
diam. 25 mm

FL036R 135 g

mit auswechselbaren
Kunststoffbacken
with interchangeable
plastic discs

185 mm, 7 1/4"

FL037

Ersatzbackenpaar
Pair of spare discs

1/2



Ø 30 mm
diam. 30 mm

COTTLE

FL038R 235 g

1 Seite flach, 1 Seite convex

1 side flat, 1 side convex

185 mm, 7 1/4"

1/2



Ø 25 mm
diam. 25 mm

FL039R 130 g

mit einer flachen und einer
aufgerauhten Fläche
with one smooth and one
rough surface

185 mm, 7 1/4"

1/2

FL





Hämmer und Meißel – Mallets, Chisels and Gouges

Hämmer
Mallets

Die Gewichtsangaben beziehen sich auf den Kopf des jeweiligen Hammers
Weights refer to the heads of the mallets



Ø 22 mm
diam. 22 mm

DF112R 80 g
165 mm, 6 1/2"

1/2



Ø 22 mm
diam. 22 mm

DF114R 155 g
190 mm, 7 1/2"

1/2



Ø 27 mm
diam. 27 mm

HAJEK

FLO44R 135 g
220 mm, 8 3/4"

1/2

FL

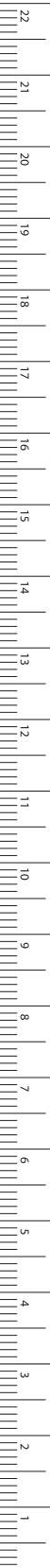

MILLIMETERS

Hämmer und Meißel – Mallets, Chisels and Gouges

Hämmer

Mallets

Die Gewichtsangaben beziehen sich auf den Kopf des jeweiligen Hammers

Weights refer to the heads of the mallets

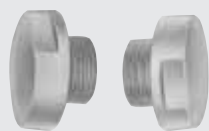

FL047

Ersatzbackenpaar
Pair of spare disks

Dampfsterilisierbar bis
143°C (3 bar)

Can be sterilized in a
steam sterilizer up to
143°C (3 bar)



FL064R 215 g

1 Metallbacke, plan
1 Metallbacke, convex
1 metal disc, flat
1 metal disc, convex

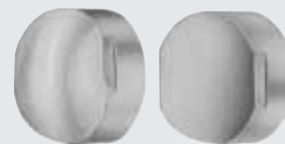

FL065 30 g

1 Kunststoffbacke, plan
1 Kunststoffbacke, convex
1 plastic disc, flat
1 plastic disc, convex



FL045R 200 g

mit auswechselbaren
Kunststoffbacken
with interchangeable
plastic discs
245 mm, 9 3/4"



FL010 42 mm

FL011 50 mm
250 mm, 10"



Hammerkopf ohne Backen 125 g
Mallet head without disks 125 g

WAGNER

FL062

komplett mit:

FL064R 1 Paar Metallbacken
FL065 1 Paar Kunststoffbacken
1 Schlüssel

complete with:

FL064R 1 pair of metal discs
FL065 1 pair of plastic discs
1 wrench

235 mm, 9 1/4"



Hämmer und Meißel – Mallets, Chisels and Gouges

Hämmer
Mallets

Die Gewichtsangaben beziehen sich auf den Kopf des jeweiligen Hammers
Weights refer to the heads of the mallets



FLO70S 425 g

Kopf aus Implantatwerkstoff
Head made of material
used for implants
235 mm, 9 1/4"



BERGMANN

FLO60R 300 g

245 mm, 9 3/4"



BERGMANN

FLO55R 245 g

235 mm, 9 1/4"

FL

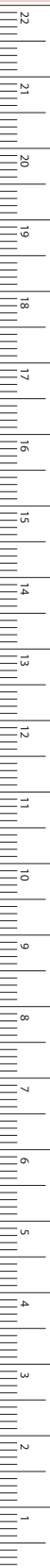

Hämmer und Meißel – Mallets, Chisels and Gouges

Hämmer

Mallets

Die Gewichtsangaben beziehen sich auf den Kopf des jeweiligen Hammers

Weights refer to the heads of the mallets



FL059R 285 g
240 mm, 9 1/2"



OMBREDANNE
FL066R 520 g
240 mm, 9 1/2"



HEATH
Ø diam.
FL068C 660 g 40 mm 185 mm, 7 1/4"
FL069C 725 g 45 mm 200 mm, 8"

mit Kupferfüllung
with cooper filled head

FL





Hämmer und Meißel – Mallets, Chisels and Gouges

Stößel
Tampers

FL



FL097R
2,5 mm

FL098R
3,5 mm

PASSOW

FL097R-FL098R

120 mm, 4 3/4"

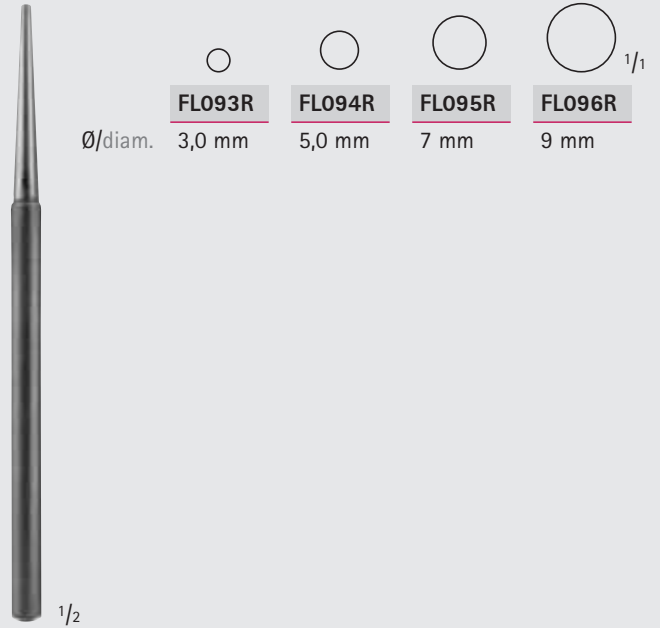

FL093R
Ø/diam. 3,0 mm

FL094R
5,0 mm

FL095R
7 mm

FL096R
9 mm

1/2

FL093R-FL096R

160 mm, 6 1/2"



FF913R
Ø/diam. 3 mm

FF914R
5 mm

FF915R
8 mm

1/2

CASPAR

FF913R-FF915R

200 mm, 8"



FL090R
Ø/diam. 12 mm

FL091R
14 mm

FL092R
16 mm

1/2

FL090R-FL092R

200 mm, 8"



MILLIMETERS

Hämmer und Meißel – Mallets, Chisels and Gouges

Osteotome, Flach- und Hohlmeißel

Osteotomes, Chisels and Gouges

FL

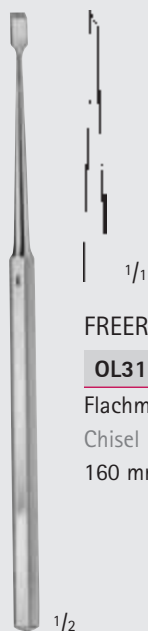

FREER

OL311R 4 mm

Flachmeißel

Chisel

160 mm, 6 1/4"

1/2

1/1

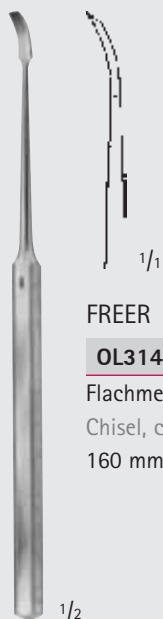

FREER

OL314R 4 mm

Flachmeißel, gebogen

Chisel, curved

160 mm, 6 1/4"

1/2

1/1

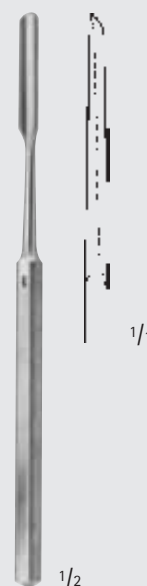

FREER

OL316R 6 mm

Hohlmeißel

Gouge

150 mm, 6"

1/2

1/1



MANNERFELT MODIF.

FL144R 4 mm

FL146R 6 mm

FL148R 8 mm

Osteotome

Osteotomes

155 mm, 6"

1/2

1/1



MANNERFELT MODIF.

FL153R 3 mm

Hohlmeißel

Gouge

155 mm, 6"

1/2

1/1



KRÄMER

FL711R 2,6 mm

Osteophyten-Meißel
mit Griff

Chisel for osteophytes
with handle

215 mm, 8 1/2"

1/2



1/1



Hämmer und Meißel – Mallets, Chisels and Gouges



Osteotome, Flach- und Hohlmeißel
Osteotomes, Chisels and Gouges

FL

FL110R	4 mm
FL112R	6 mm
FL114R	8 mm
FL116R	10 mm
FL118R	12 mm

Osteotome
Osteotomes
140 mm, 5 1/2"

FL120R	4 mm
FL122R	6 mm
FL124R	8 mm
FL126R	10 mm
FL128R	12 mm

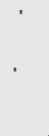

Flachmeißel
Chisels
140 mm, 5 1/2"

GILLIES

OL341R	5 mm
OL342R	7 mm
OL343R	9 mm

Osteotome
Osteotomes
140 mm, 5 1/2"

FL130R	4 mm
FL132R	6 mm
FL134R	8 mm
FL136R	10 mm
FL138R	12 mm

Hohlmeißel
Gouges
140 mm, 5 1/2"



MILLIMETERS

Hämmer und Meißel – Mallets, Chisels and Gouges

Flach- und Hohlmeißel

Chisels and Gouges

FL



PARTSCH

FL173R	3 mm
FL174R	4 mm
FL175R	5 mm
FL176R	6 mm

Flachmeißel

Chisels

140 mm, 5 1/2"

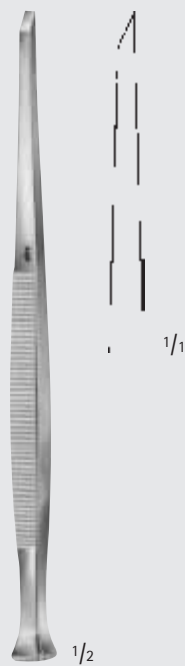

PARTSCH

FL183R	3 mm
FL184R	4 mm
FL185R	5 mm
FL186R	6 mm
FL187R	7 mm

Flachmeißel

Chisels

170 mm, 6 3/4"



PARTSCH

FL213R	3 mm
FL214R	4 mm
FL215R	5 mm
FL216R	6 mm

Hohlmeißel

Gouges

140 mm, 5 1/2"

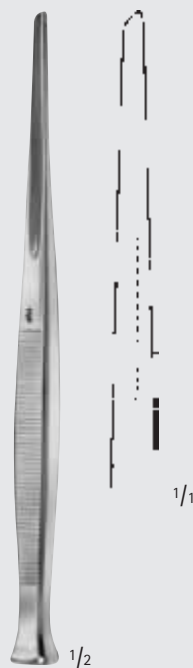

PARTSCH

FL223R	3 mm
FL224R	4 mm
FL225R	5 mm
FL226R	6 mm
FL227R	7 mm

Hohlmeißel

Gouges

170 mm, 6 3/4"



Hämmer und Meißel – Mallets, Chisels and Gouges

Osteotome, Flach- und Hohlmeißel
Osteotomes, Chisels and Gouges

FL

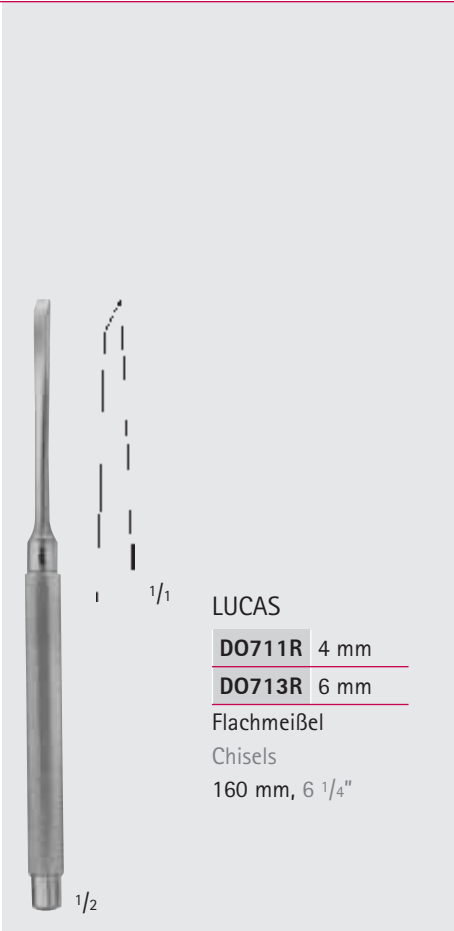

LUCAS

DO711R	4 mm
DO713R	6 mm

Flachmeißel

Chisels

160 mm, 6 1/4"

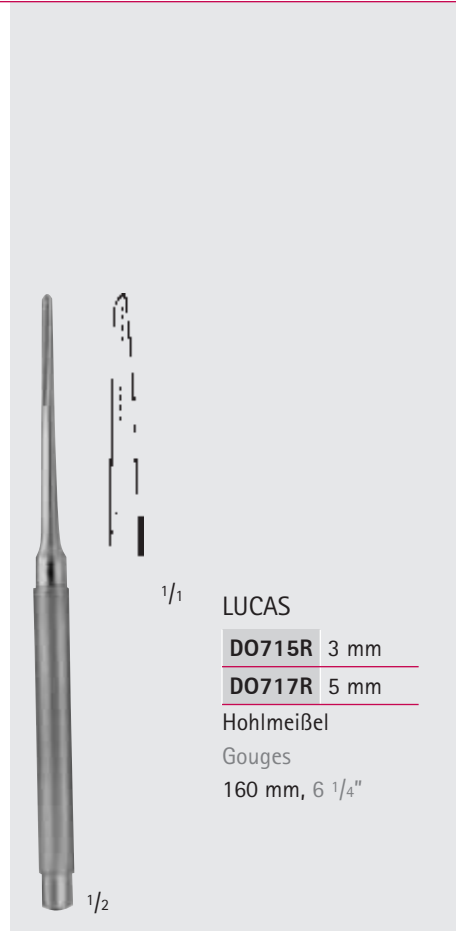

LUCAS

DO715R	3 mm
DO717R	5 mm

Hohlmeißel

Gouges

160 mm, 6 1/4"



ALEXANDER

FL343R	7 mm
FL345R	9 mm
FL347R	11 mm

Hohlmeißel

Gouges

170 mm, 6 3/4"

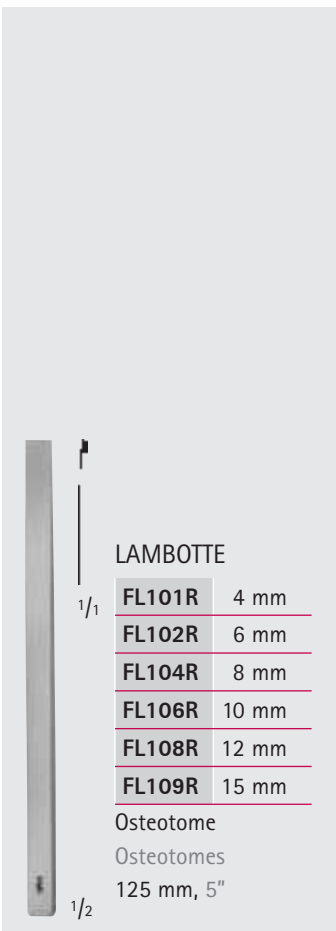

LAMBOTTE

FL101R	4 mm
FL102R	6 mm
FL104R	8 mm
FL106R	10 mm
FL108R	12 mm
FL109R	15 mm

Osteotome

Osteotomes

125 mm, 5"

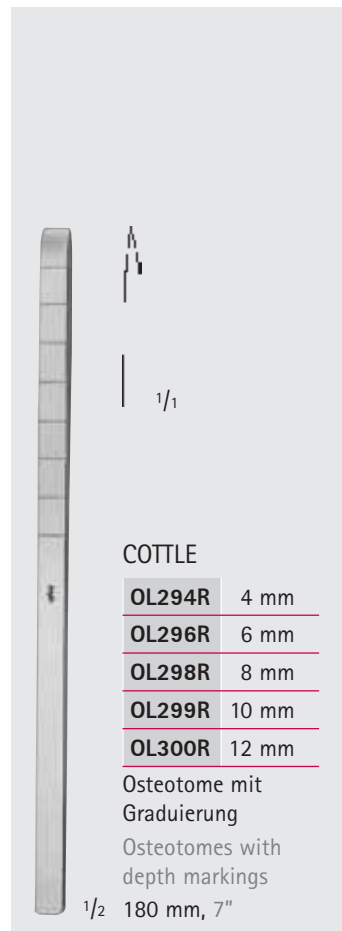

COTTLE

OL294R	4 mm
OL296R	6 mm
OL298R	8 mm
OL299R	10 mm
OL300R	12 mm

Osteotome mit
Graduierung

Osteotomes with
depth markings

180 mm, 7"

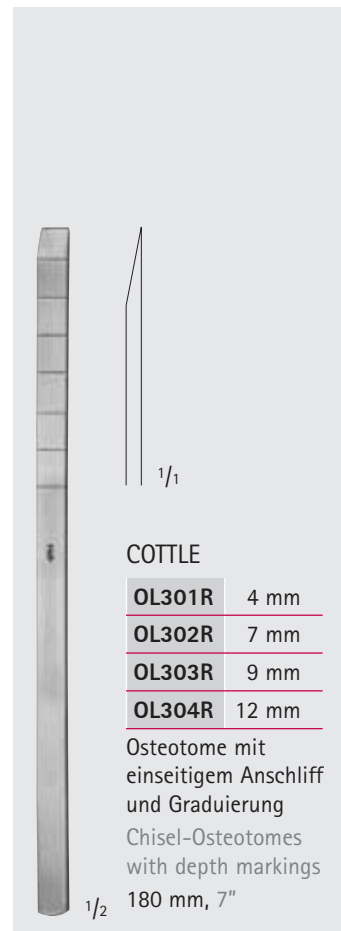

COTTLE

OL301R	4 mm
OL302R	7 mm
OL303R	9 mm
OL304R	12 mm

Osteotome mit
einseitigem Anschlag
und Graduierung

Chisel-Osteotomes
with depth markings

180 mm, 7"

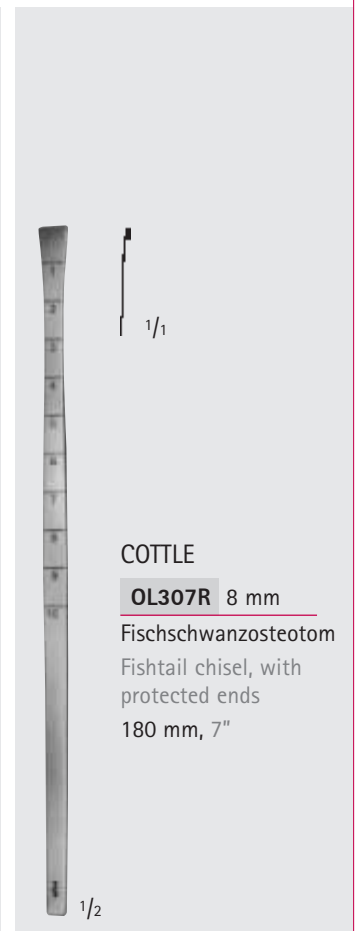

COTTLE

OL307R	8 mm
---------------	------

Fischschwanzosteotom

Fishtail chisel, with
protected ends

180 mm, 7"



MILLIMETERS

Hämmer und Meißel – Mallets, Chisels and Gouges

Flachmeißel und Osteotome

Chisels and Osteotomes

FL



EAST GRINSTEAD (WARD)

DO722R 3 mm

DO723R 5 mm

Flachmeißel

Chisels

180 mm, 7"

1/2



EASTMAN

DO725R 3 mm

DO726R 5 mm

Flachmeißel

Chisels

190 mm, 7 1/2"

1/2



EAST GRINSTEAD (WARD)

DO732R 3 mm

DO733R 5 mm

Osteotome

Osteotomes

180 mm, 7"

1/2



Hämmer und Meißel – Mallets, Chisels and Gouges

Flach- und Hohlmeißel, Osteotome
Chisels and Gouges, Osteotomes

FL

1/1

1/2 205 mm, 8"

STILLE

FL503R	10 mm
FL504R	12 mm
FL505R	15 mm
FL506R	20 mm
FL507R	25 mm

Flachmeißel
Chisels

1/1

1/2 205 mm, 8"

STILLE

FL573R	10 mm
FL574R	12 mm
FL575R	15 mm
FL576R	20 mm
FL577R	25 mm

Hohlmeißel
Gouges

1/1

1/2 205 mm, 8"

WALTER

FL583R	10 mm
FL585R	15 mm

Hohlmeißel zur
Knorpelentnahme aus der
Rippe
Gouges for taking grafts
from the ribs

1/1

1/2 205 mm, 8"

STILLE

FL512R	8 mm
FL513R	10 mm
FL514R	12 mm
FL515R	15 mm
FL516R	20 mm
FL517R	25 mm

Osteotome
Osteotomes

1/1

1/2 205 mm, 8"

STILLE

FL523R	10 mm
FL524R	12 mm
FL525R	15 mm
FL526R	20 mm
FL527R	25 mm

Osteotome
Osteotomes

1/1

1/2 205 mm, 8"

STILLE

FL553R	10 mm
FL554R	12 mm
FL555R	15 mm
FL556R	20 mm
FL557R	25 mm

Osteotome, gebogen
Osteotomes, curved



Hämmer und Meißel – Mallets, Chisels and Gouges

Osteotome

Osteotomes

FL



MB657R-MB662R



MB663R-MB669R



MB675R-MB684R



MB685R-MB694R



SMITH-PETERSEN

MB657R	7 mm
MB658R	11 mm
MB659R	14 mm
MB660R	17 mm
MB661R	19 mm
MB662R	25 mm
MB663R	6 mm
MB664R	9,5 mm
MB665R	13 mm
MB666R	16 mm
MB667R	19 mm
MB668R	25 mm
MB669R	32 mm

1/2

205 mm, 8 1/8"



HIBBS

MB675R	6 mm
MB676R	10 mm
MB677R	13 mm
MB678R	16 mm
MB679R	19 mm
MB680R	22 mm
MB681R	25 mm
MB682R	28 mm
MB683R	32 mm
MB684R	38 mm
MB685R	6 mm
MB686R	10 mm
MB687R	13 mm
MB688R	16 mm
MB689R	19 mm
MB690R	22 mm
MB691R	25 mm
MB692R	28 mm
MB693R	32 mm
MB694R	38 mm

1/2

240 mm, 9 1/2"



Hämmer und Meißel – Mallets, Chisels and Gouges

Osteotome
Osteotomes

FL



LAMBOTTE

FL650R	4 mm
FL651R	8 mm
FL652R	10 mm
FL653R	13 mm
FL654R	15 mm
FL655R	18 mm
FL656R	20 mm
FL658R	25 mm
FL659R	30 mm
FL660R	38 mm
FL661R	44 mm
FL662R	50 mm

245 mm, 9 3/4"

1/2

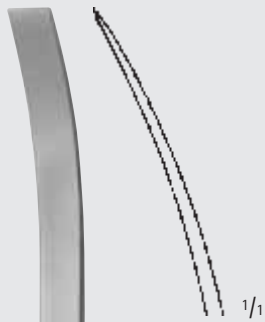

LAMBOTTE

FL781R	8 mm
FL783R	13 mm
FL785R	18 mm
FL788R	25 mm
FL789R	30 mm
FL790R	38 mm

gebogen
curved
245 mm, 9 3/4"

1/2



OBWEGESER

DO720R 11 mm

gebogen
curved
235 mm, 9 1/4"

1/2

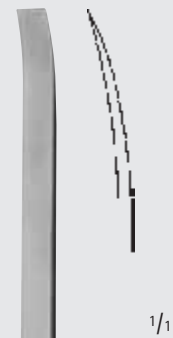

NIEDERDELLMANN

DO728R 8 mm

DO730R 10 mm

gebogen
curved
250 mm, 10"

1/2

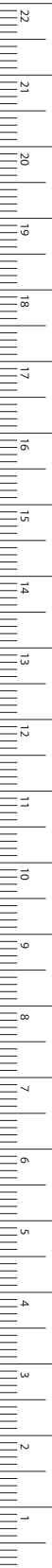

MILLIMETERS

Hämmer und Meißel – Mallets, Chisels and Gouges

Osteotome, Flach- und Hohlmeißel mit PEEK-Griff

Osteotomes, Chisels and Gouges with PEEK-Handle

Dampfsterilisierbar bis 143°C (3 bar)

Can be sterilized in a steam sterilizer up to 143°C (3 bar)

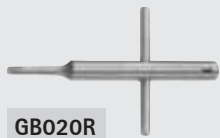

FL665R
Meißelgriff für
auswechselbare Klingen
mit Spannschlüssel GB020R
Handle for interchangeable
blades, with key GB020R

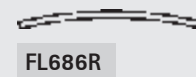
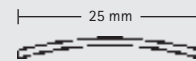
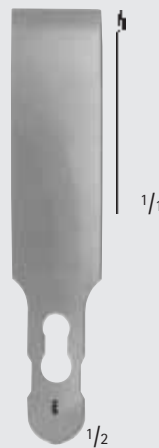
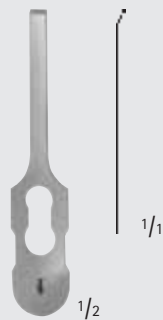



Hämmer und Meißel – Mallets, Chisels and Gouges

Osteotome, Flach- und Hohlmeißel mit PEEK-Griff
Osteotomes, Chisels and Gouges with PEEK-Handle

Dampfsterilisierbar bis 143°C (3 bar)

Can be sterilized in a steam sterilizer up to 143°C (3 bar)

FL



- DO750R** 10 mm
- DO752R** 15 mm
- DO754R** 20 mm

Flachmeißel
Chisels
200 mm, 8"



- DO751R** 10 mm
- DO753R** 15 mm
- DO755R** 20 mm

Flachmeißel, gebogen
Chisels, curved
200 mm, 8"



LEXER-MINI

- FL380R** 4 mm
- FL381R** 6 mm
- FL382R** 8 mm
- FL383R** 10 mm
- FL384R** 12 mm

Osteotome
Osteotomes
180 mm, 7"



LEXER-MINI

- FL390R** 4 mm
- FL391R** 6 mm
- FL392R** 8 mm
- FL393R** 10 mm
- FL394R** 12 mm

Hohlmeißel
Gouges
180 mm, 7"

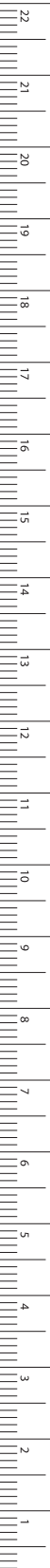

MILLIMETERS

Hämmer und Meißel – Mallets, Chisels and Gouges

Osteotome und Hohlmeißel mit PEEK-Griff

Osteotome and Gouges with PEEK-Handle

Dampfsterilisierbar bis 143°C (3 bar)

Can be sterilized in a steam sterilizer up to 143°C (3 bar)

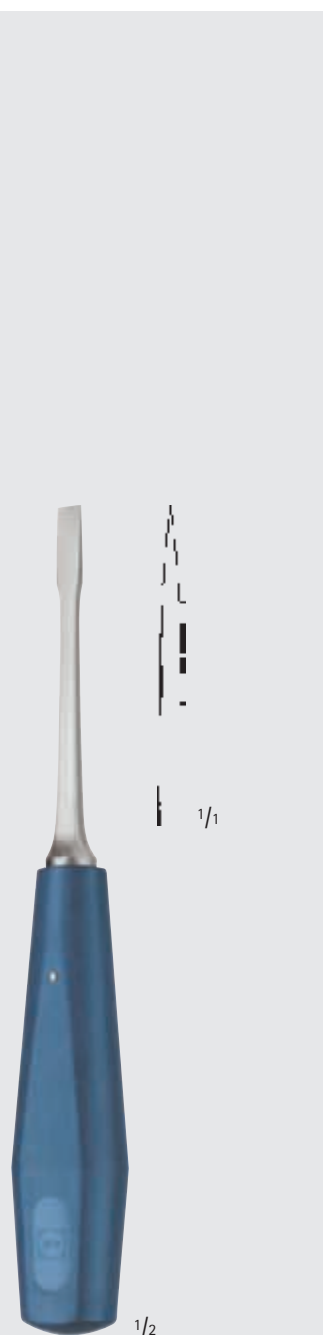

LEXER

FL401R	5 mm
FL402R	7 mm
FL403R	10 mm
FL405R	15 mm
FL406R	20 mm
FL407R	25 mm
FL408R	30 mm

Osteotome
Osteotomes

220 mm, 8 3/4"

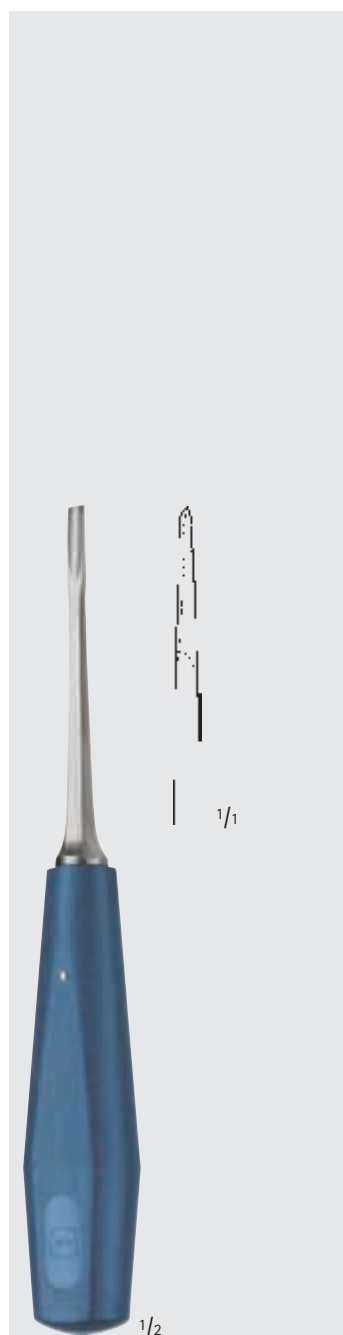

LEXER

FL411R	5 mm
FL412R	7 mm
FL413R	10 mm
FL415R	15 mm
FL416R	20 mm
FL417R	25 mm
FL418R	30 mm

Hohlmeißel
Gouges

220 mm, 8 3/4"

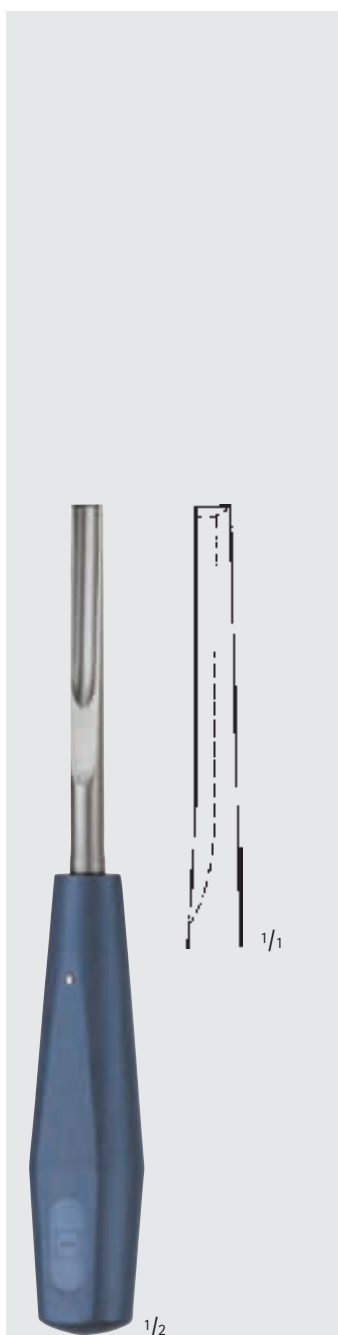

FL420R 9 mm

Hohlmeißel zum Freilegen
abgebrochener Schrauben

Gouge for excavating
broken screws

220 mm, 8 3/4"



ZIELKE

FL701R	5,5 mm
FL702R	9,0 mm

Hohlmeißel für
Skoliose-Operationen

Gouges for scoliosis
operations

230 mm, 9"

FL





Hämmer und Meißel – Mallets, Chisels and Gouges

Hohlmeißel

Gouges

Dampfsterilisierbar bis 143°C (3 bar)

Can be sterilized in a steam sterilizer up to 143°C (3 bar)



FL437R	6 mm
FL438R	8 mm
FL439R	11 mm
FL440R	16 mm

Wirbelsäulenmeißel,
bajonettförmig
Lamina gouge, cranked
235 mm, 9 1/4"

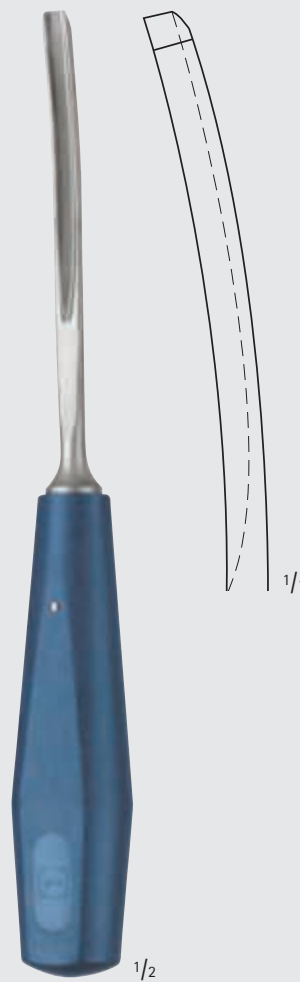

FL441R	5 mm
FL443R	10 mm
FL445R	15 mm

Spongiosa-Hohlmeißel,
gebogen
Spongiosa gouges, curved
250 mm, 10"

FL

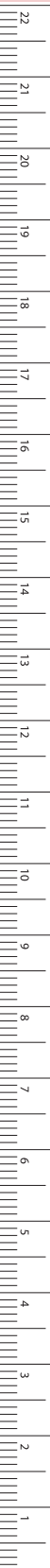

MILLIMETERS

Hämmer und Meißel – Mallets, Chisels and Gouges

Osteotome und Flachmeißel mit PEEK-Griff

Osteotomes and Chisels with PEEK-Handle

Dampfsterilisierbar bis 143°C (3 bar)

Can be sterilized in a steam sterilizer up to 143°C (3 bar)

FL



FL430R 20 mm

Flachmeißel

Chisel

245 mm, 9 3/4"

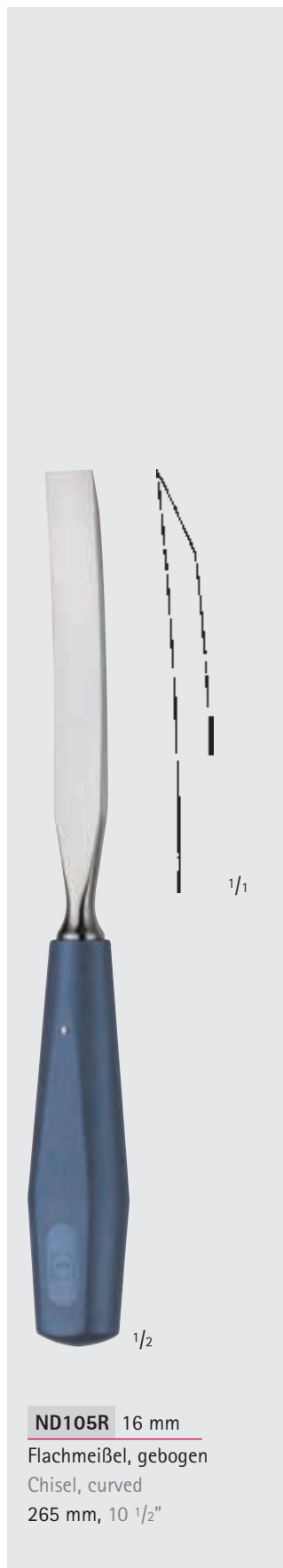

ND105R 16 mm

Flachmeißel, gebogen

Chisel, curved

265 mm, 10 1/2"

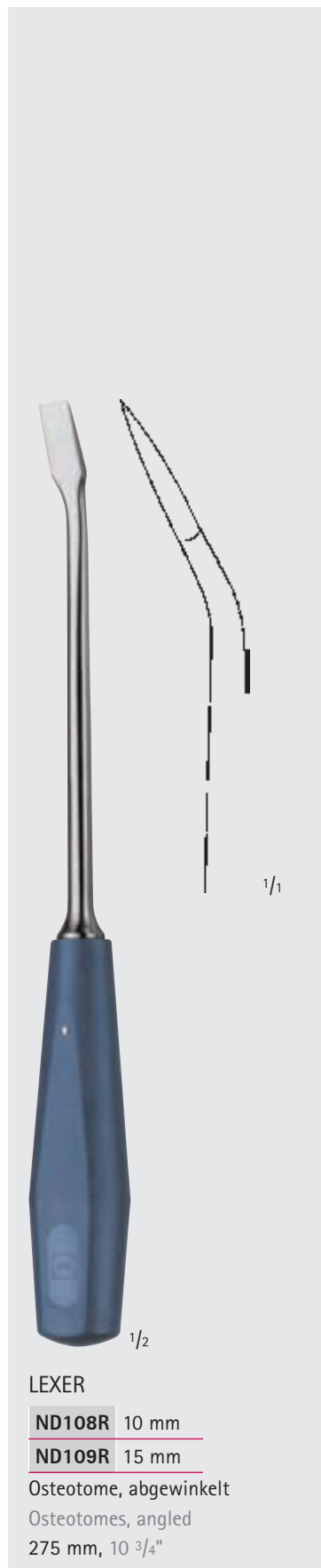

LEXER

ND108R 10 mm

ND109R 15 mm

Osteotome, abgewinkelt

Osteotomes, angled

275 mm, 10 3/4"



LEXER

FL423R

Spongiosa-Hohlmeißel

Spongiosa gouge

280 mm, 11"



Hämmer und Meißel – Mallets, Chisels and Gouges

Hohlmeißel





Gouges

Dampfsterilisierbar bis 143°C (3 bar)

Can be sterilized in a steam sterilizer up to 143°C (3 bar)

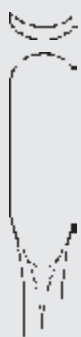
FL



		
	9 mm	15 mm ^{1/1}
	ND120R	ND122R
aufgebogen inclined forward		
	ND121R	ND123R
rückwärts gebogen inclined backward		
	ND124R	ND125R
gerade straight		

WAGNER

ND120R-ND125R ^{1/2}

Hohlmeißel zum Abtragen von Osteophyten sowie zum Anbringen von Verankerungsrillen im Acetabulum. Auch sehr gut geeignet zur Zemententfernung bei Reoperationen von Schaftprothesen.

Long handled thin concave gouges for removal of osteophytes as well as for creating small notches throughout the acetabular surface. The instruments can also be used for removing bone cement from the marrow-cavity when removing a total hip prosthesis.

340 mm, 13 1/2"

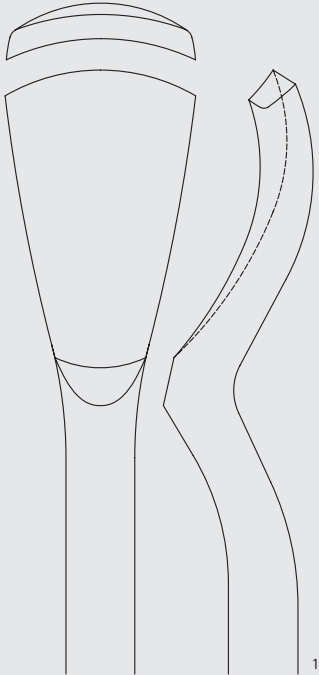
ND118R 25 mm ^{1/2}

290 mm, 11 1/4"



MILLIMETERS



INCHES

FO



**Knochenhaltezangen, Hohlmeißelzangen,
Knochensplitterzangen**

Bone Holding Forceps, Bone Rongeurs,
Bone Cutting Forceps

Knochenhaltezangen, Hohlmeißelzangen – Bone Holding Forceps, Bone Rongeurs

Distraktor, Repositionszangen

Distractor, Reposition Forceps

FO

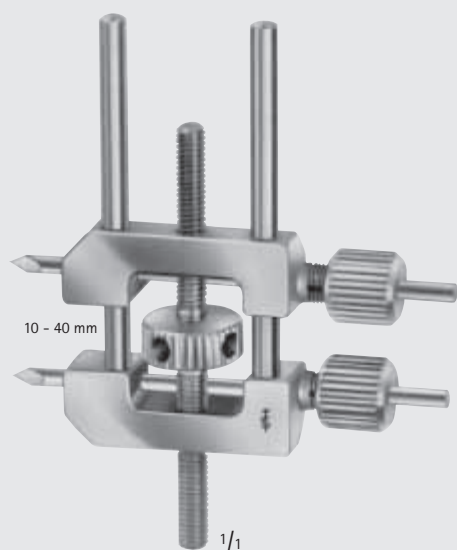

LX310R

Kleiner Distraktor, zum Distrahieren und Komprimieren von kleinen Knochen, für Bohrdrähte Ø 3,0 mm
Small distractor, a repositioning device for distraction and compression of small bones, for wires with 3.0 mm diam.

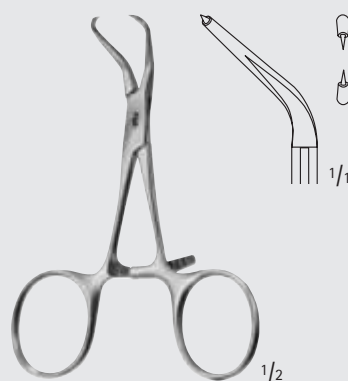

FO113R

Repositionszange mit abgesetzten Spitzen
Reposition forceps with stepped tips
95 mm, 3 3/4"

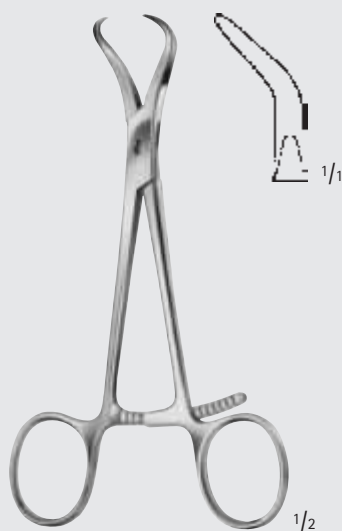

FO115R

Repositionszange für Kleinfragmente
Reposition forceps for small fragments
135 mm, 5 1/4"

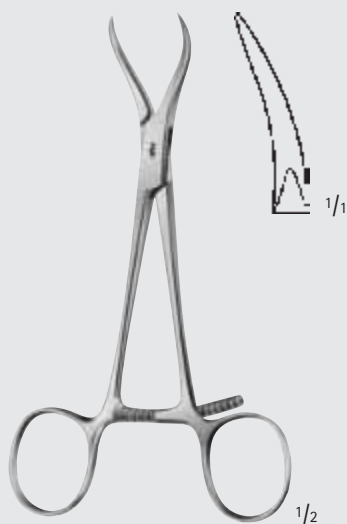

FO117R

Repositionszange, speziell für Kieferrepositionen
Reposition forceps, especially for maxillary reposition
135 mm, 5 1/4"

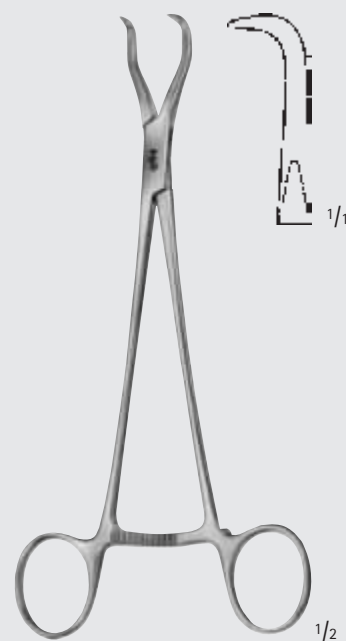

HAASE

FO119R

Repositionszange für Unterkieferfrakturen
Reposition forceps for mandibular fractures
165 mm, 6 1/2"



Knochenhaltezangen, Hohlmeißelzangen – Bone Holding Forceps, Bone Rongeurs

Repositionszangen, Repositionsstößel
Reposition Forceps, Reposition Tamper

FO



Zum Fixieren eines anzuschraubenden Knochenteils mittels KIRSCHNER-Bohrdraht bis Ø 2 mm
A bone part to be screwed on is fixed by using a KIRSCHNER wire up to diam. 2 mm

WÖRRLEIN

FO105R

Repositionsstößel (Kronenspieß), längsdurchbohrt
Reposition tamper, cannulated
165 mm, 6 1/2"

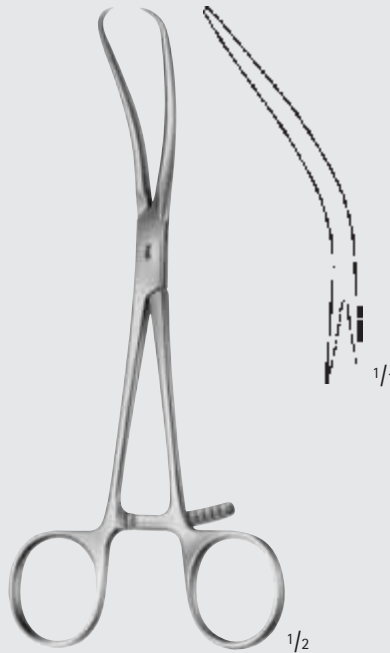

REILL

FO116R

Repositionszange
Reposition forceps
170 mm, 6 3/4"



FO118R

Repositionszange
Reposition forceps
205 mm, 8"

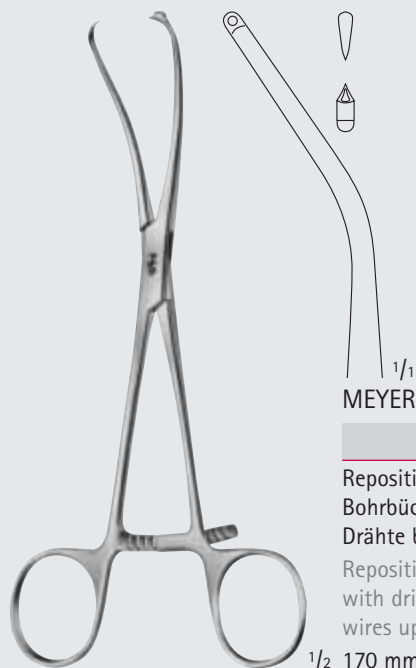

MEYER

FO106R

Repositionszange für Finger, mit Bohrbüchse für KIRSCHNER-Drähte bis Ø 1 mm
Reposition forceps for fingers, with drill guide for KIRSCHNER wires up to diam. 1 mm
170 mm, 6 3/4"

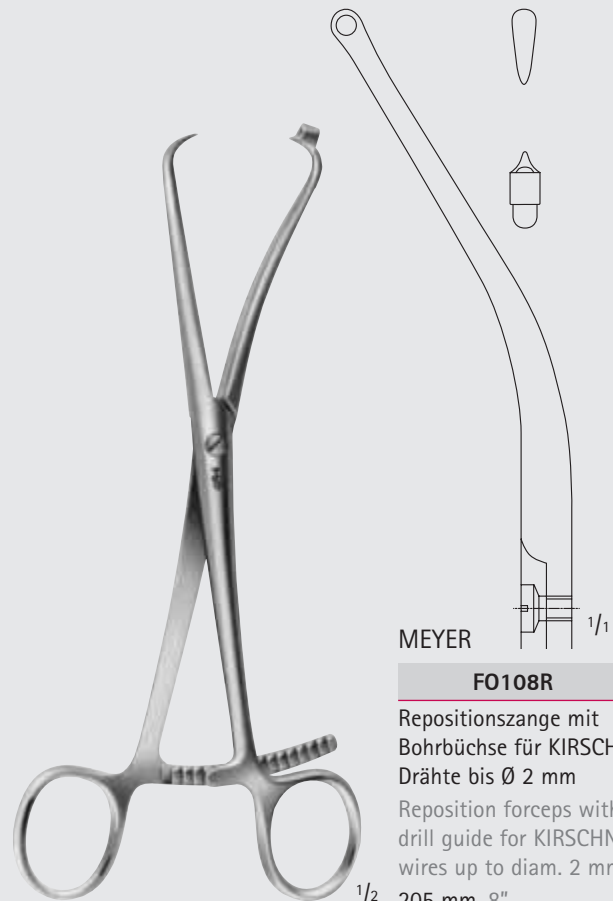

MEYER

FO108R

Repositionszange mit Bohrbüchse für KIRSCHNER-Drähte bis Ø 2 mm
Reposition forceps with drill guide for KIRSCHNER wires up to diam. 2 mm
205 mm, 8"

Knochenhaltezangen, Hohlmeißelzangen – Bone Holding Forceps, Bone Rongeurs

Repositionierzangen, Knochenhaltezangen
 Reposition Forceps, Bone Holding Forceps

FO



1/2

FO153R

Patellazange
 Patella forceps
 185 mm, 7 1/4"



1/2

FO112R

Knöchelfasszange
 Malleolar forceps
 210 mm, 8 1/4"



1/2

FO123R

Zange mit Zahnsperre
 Forceps with ratchet fixation
 140 mm, 5 1/2"



1/2

FO124R

Zange mit Gewindesperre
 Forceps with thread fixation
 170 mm, 6 3/4"



1/2

FO125R

Zange mit Gewindesperre
 Forceps with thread fixation
 235 mm, 9 1/4"



Knochenhaltezangen, Hohlmeißelzangen – Bone Holding Forceps, Bone Rongeurs

Knochenhaltezangen
Bone Holding Forceps

FO



DINGMANN

FO110R

185 mm, 7 1/4"

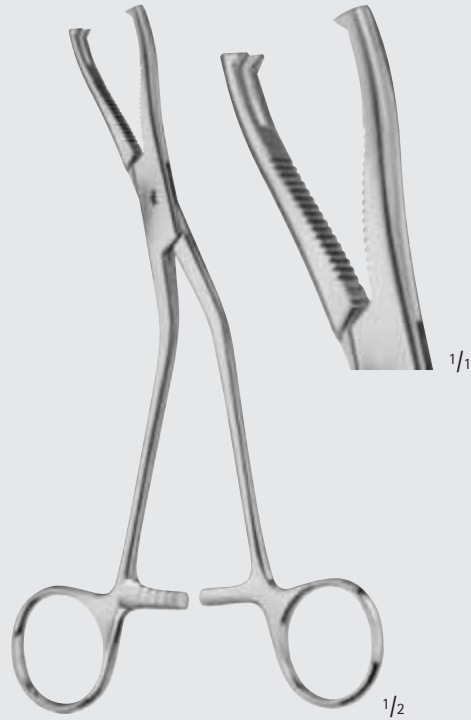

DINGMANN, MODIF.

FO111R

185 mm, 7 1/4"



FO100R

Sequesterzange
Sequestrum forceps
200 mm, 8"

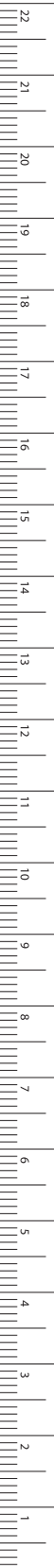

MILLIMETERS

Knochenhaltezangen, Hohlmeißelzangen – Bone Holding Forceps, Bone Rongeurs

Knochenhaltezangen
Bone Holding Forceps

FO



5 mm



1/2

FO120R

200 mm, 8"

11 mm



1/2

LANGENBECK

FO127R

205 mm, 8"

12 mm



1/2

FERGUSSON

FO130R

205 mm, 8"

8 mm



1/1



1/2

SEMB

FO135R

190 mm, 7 1/2"

8 mm



1/1



1/2

SEMB

FO136R

190 mm, 7 1/2"



Knochenhaltezangen, Hohlmeißelzangen – Bone Holding Forceps, Bone Rongeurs

Knochenhaltezangen Bone Holding Forceps

FO

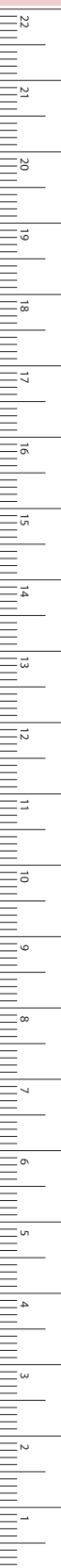

im Maul verstellbar
jaw adjustable



FARABEUF

FO140R

230 mm, 9"



FARABEUF

FO141R

255 mm, 10"



FARABEUF-LAMBOTTE

FO143R

255 mm, 10"

MILLIMETERS

Knochenhaltezangen, Hohlmeißelzangen – Bone Holding Forceps, Bone Rongeurs

Knochenhaltezangen
Bone Holding Forceps

FO

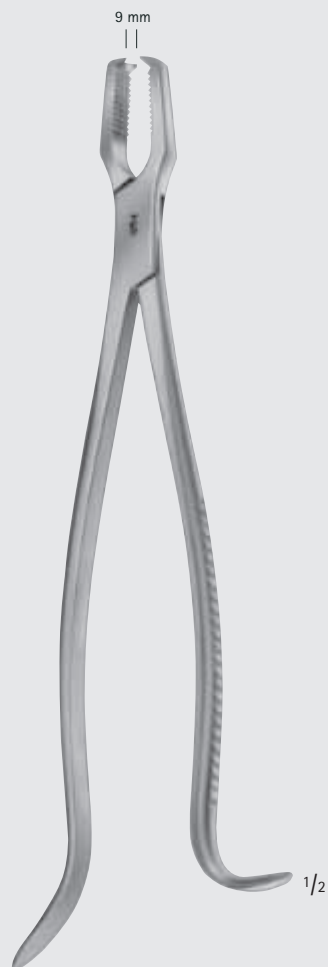

KERN-LANE

FO150R

240 mm, 9 1/2"

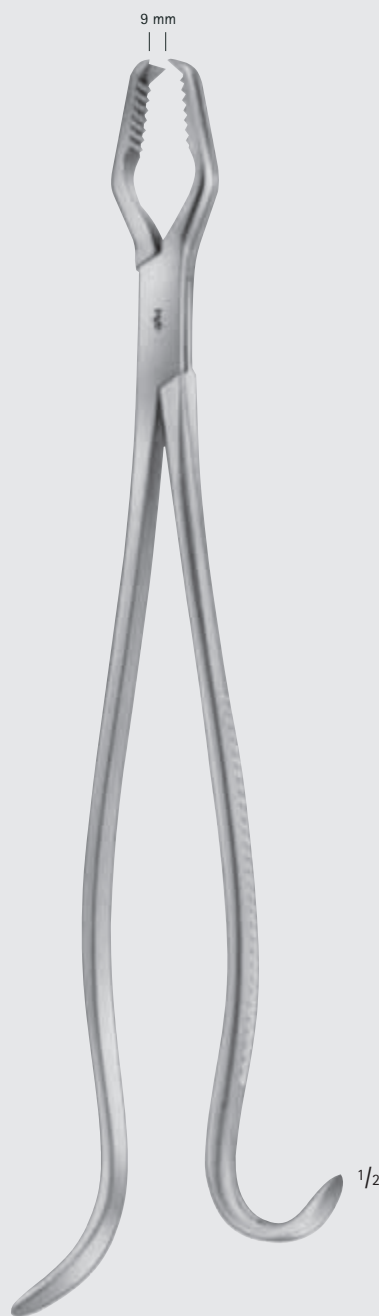

LANE

FO151R

330 mm, 13 1/8"



Knochenhaltezangen, Hohlmeißelzangen – Bone Holding Forceps, Bone Rongeurs

Knochenhaltezangen
Bone Holding Forceps

FO



KERN-MINI

FO148R

155 mm, 6"



KERN-LANE

FO158R

240 mm, 9 1/2"



LANE

FO159R

320 mm, 12 3/4"



MILLIMETERS

Knochenhaltezangen, Hohlmeißelzangen – Bone Holding Forceps, Bone Rongeurs

Knochenhaltezangen
Bone Holding Forceps

FO



HEY GROVES

FO144R

210 mm, 8 1/4"



HEY GROVES

FO145R

270 mm, 10 3/4"



HEY GROVES

FO146R

305 mm, 12"



Knochenhaltezangen, Hohlmeißelzangen – Bone Holding Forceps, Bone Rongeurs

Knochenhaltezangen Bone Holding Forceps

FO



FO169R-FO173R

selbstzentrierend mit Gewindesperre
self-centering forceps with thread fixation

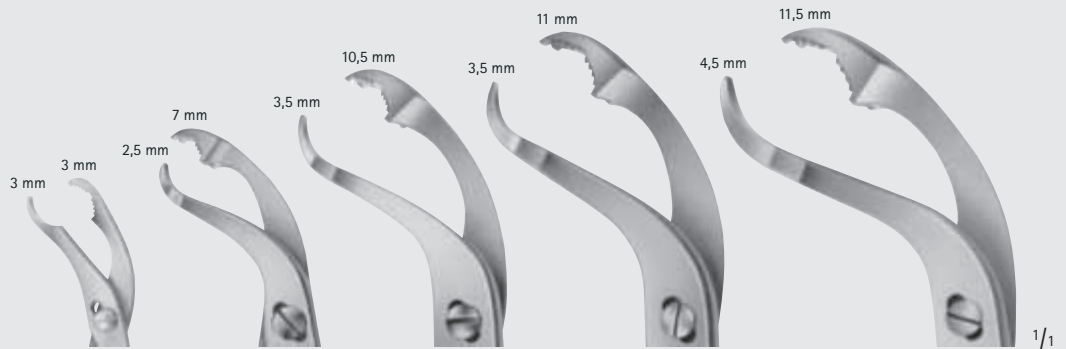

FO169R

145 mm
5 3/4"

für Klein-
fragmente
for small
fragments

FO170R

190 mm
7 1/2"

FO171R

240 mm
9 1/2"

FO172R

260 mm
10 1/4"

FO173R

280 mm
11"



VERBRUGGE

FO180R

175 mm, 7"



Fig. 1

FO181R

255 mm
10"

Fig. 2

FO182R

265 mm
10 1/2"

Fig. 3

FO183R

270 mm
10 3/4"

VERBRUGGE

FO181R-FO183R

mit Lappenverschluss
with lip joint



Knochenhaltezangen, Hohlmeißelzangen – Bone Holding Forceps, Bone Rongeurs

Knochenhaltezangen
Bone Holding Forceps

FO



Maulteil beweglich
movable jaw



FO160R

220 mm

8 3/4"



FO161R

260 mm

10 1/4"



FO162R

330 mm

13 1/8"

LAMBOTTE

FO160R-FO162R

Knochenhaltezangen, Hohlmeißelzangen – Bone Holding Forceps, Bone Rongeurs

Knochenhalteklammern
Bone Clamps

FO

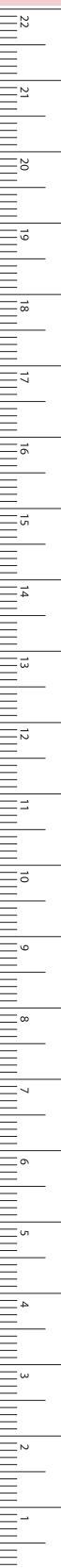

LOWMAN

FO190R 170 mm, 6 3/4"

FO191R 205 mm, 8"



LOWMAN-GERSTER

FO192R

210 mm, 8 1/4"

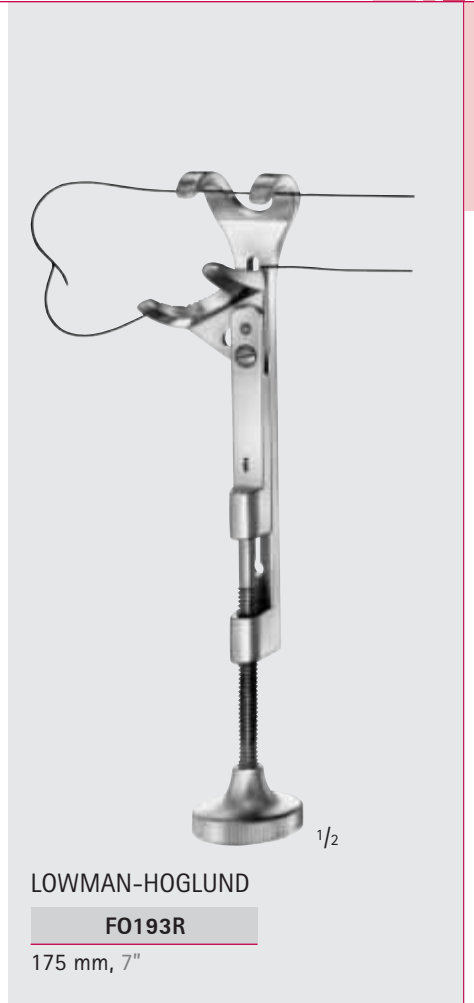

LOWMAN-HOGLUND

FO193R

175 mm, 7"

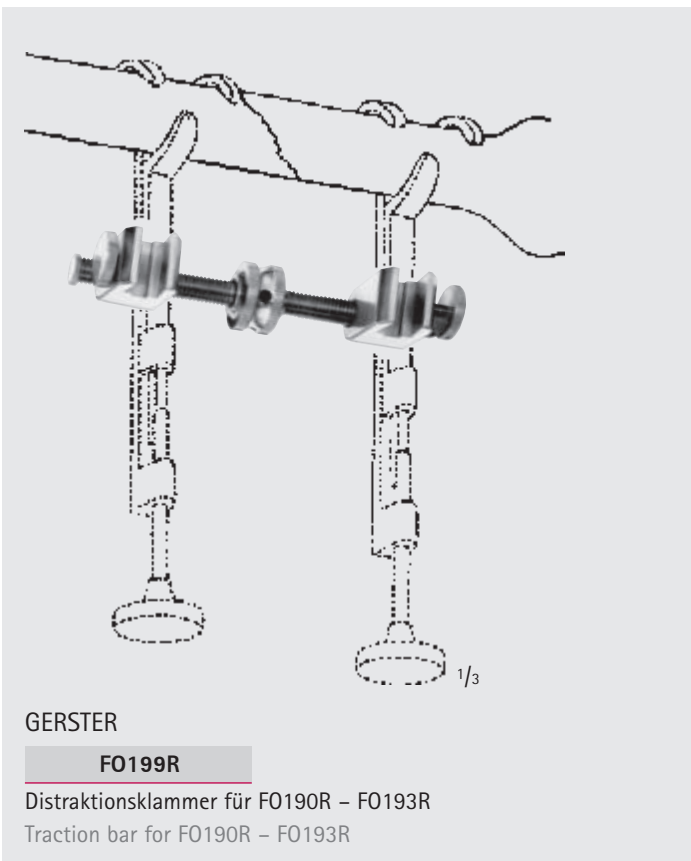

GERSTER

FO199R

Distraktionsklammer für FO190R – FO193R
Traction bar for FO190R – FO193R



LEWIN

MD455

185 mm, 7 1/4"

Knochenhaltezangen, Hohlmeißelzangen – Bone Holding Forceps, Bone Rongeurs

Synovektomie-Zangen, Hohlmeißelzangen

Synovectomy-Rongeurs, Bone Rongeurs

FO



FO599R

Synovektomie-Zange
Maulbreite 2 mm
Synovectomy rongeur
jaw width 2 mm
130 mm, 5 1/8"



STELLBRINK

FO399R

Synovektomie-Zange
Synovectomy rongeur
175 mm, 7"



STELLBRINK

FO400R

Synovektomie-Zange
Synovectomy rongeur
170 mm, 6 3/4"



FO408R

Hohlmeißelzangen
Bone rongeurs
145 mm, 5 3/4"

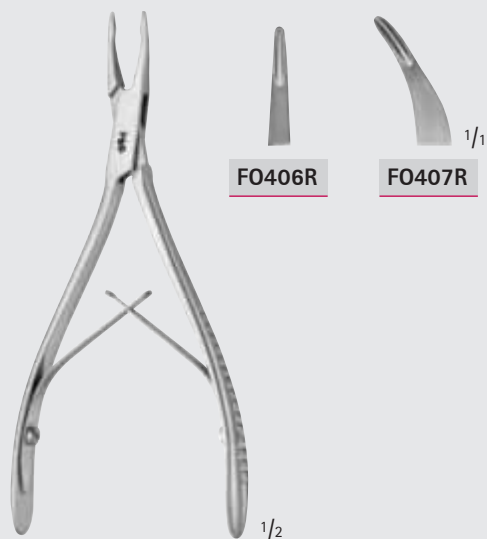

FRIEDMANN

FO406R-FO407R

Hohlmeißelzange
Bone rongeur
140 mm, 5 1/2"



LUER-FRIEDMANN

FO409R

Hohlmeißelzangen
Bone rongeurs
145 mm, 5 3/4"



Knochenhaltezangen, Hohlmeißelzangen – Bone Holding Forceps, Bone Rongeurs

Hohlmeißelzangen
Bone Rongeurs

FO

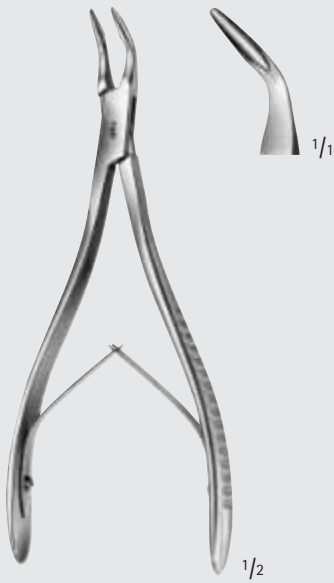

FO413R

150 mm, 6"



FO410R

140 mm, 5 1/2"



LUER

FO411R

150 mm, 6"

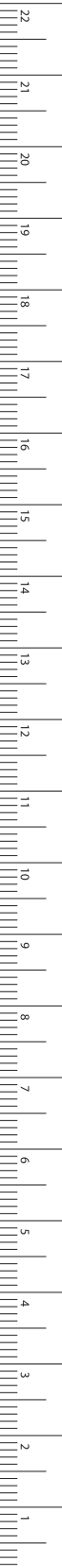

MILLIMETERS

Knochenhaltezangen, Hohlmeißelzangen – Bone Holding Forceps, Bone Rongeurs

Hohlmeißelzangen

Bone Rongeurs

FO

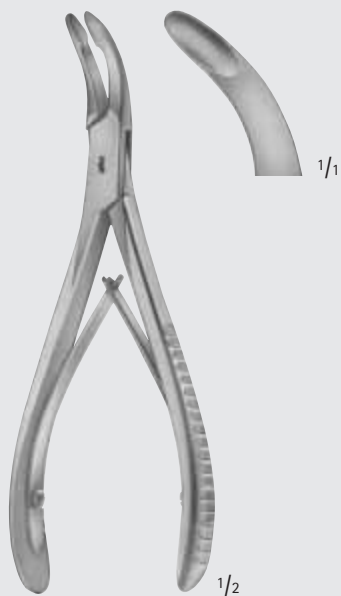

LUER

FO412R

155 mm, 6"



BLUMENTHAL

FO415R

155 mm, 6"



BLUMENTHAL

FO416R

150 mm, 6"



HAKANSSON

FO428R

170 mm, 6 3/4"



JANSEN

FO430R-FO432R

175 mm, 7"



BANE-HARTMANN

FO457R

175 mm, 7"



Knochenhaltezangen, Hohlmeißelzangen – Bone Holding Forceps, Bone Rongeurs

Hohlmeißelzangen

Bone Rongeurs

FO

ALEXANDER
FO440R
140 mm, 5 1/2"

JANSEN
FO442R
190 mm, 7 1/2"

LEMPERT
MD617
165 mm, 6 1/2"

LEMPERT
FO450R-FO451R
200 mm, 8"

BEYER
FO453R
180 mm, 7"

MEAD
FO455R
165 mm, 6 1/2"



MILLIMETERS

Knochenhaltezangen, Hohlmeißelzangen – Bone Holding Forceps, Bone Rongeurs

Hohlmeißelzangen

Bone Rongeurs

FO

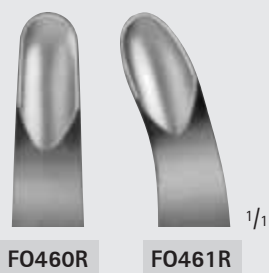

FO460R

FO461R

1/2

LUER

FO460R-FO461R

175 mm, 7"



1/1

1/2

LUER

FO462R

180 mm, 7"



1/1

1/2

LUER

FO463R

180 mm, 7"



1/1

1/2

OLIVECRONA

FO470R

205 mm, 8"



1/1

1/2

GULEKE

FO472R

205 mm, 8"

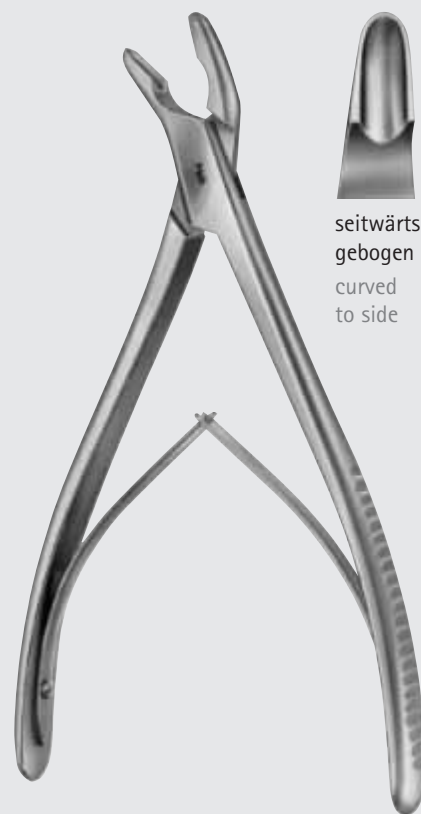

1/1

seitwärts
gebogen
curved
to side

1/2

TROTTER

FO467R

205 mm, 8"



Knochenhaltezangen, Hohlmeißelzangen – Bone Holding Forceps, Bone Rongeurs
Hohlmeißelzangen
Bone Rongeurs

FO

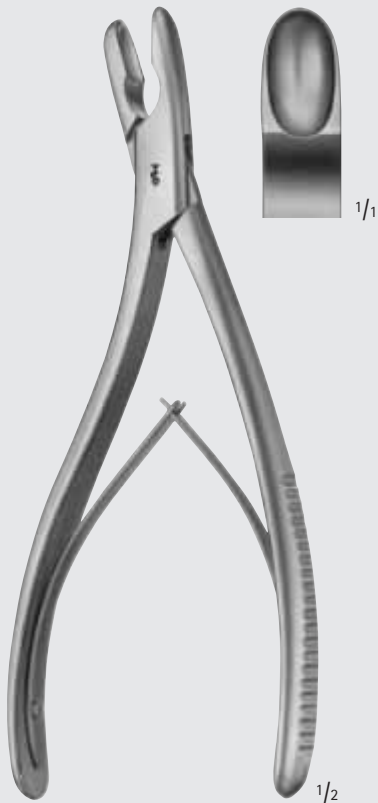
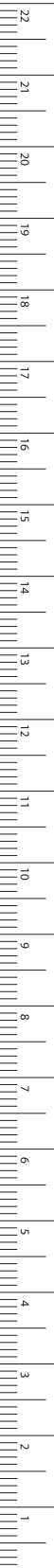

NORTHFIELD
FO474R
210 mm, 8 1/4"

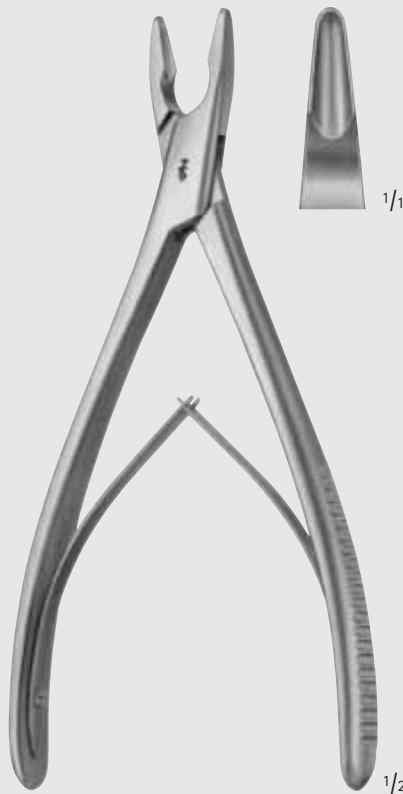

PENNYBACKER
FO475R
205 mm, 8"

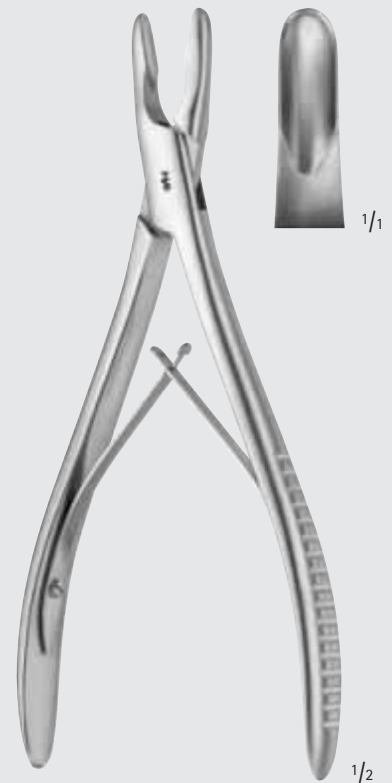

ADSON
MD615
200 mm, 8"

Knochenhaltezangen, Hohlmeißelzangen – Bone Holding Forceps, Bone Rongeurs

Hohlmeißelzangen

Bone Rongeurs

FO



FO500R **FO502R** ^{1/1}

BÖHLER
FO500R-FO502R
155 mm, 6"

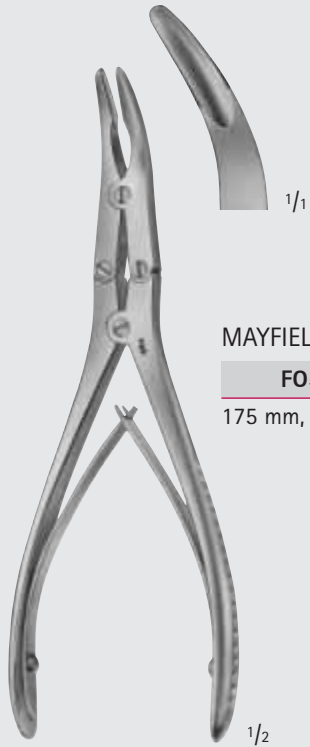

MAYFIELD
FO511R
175 mm, 7"



MARQUARDT
FO520R
200 mm, 8"

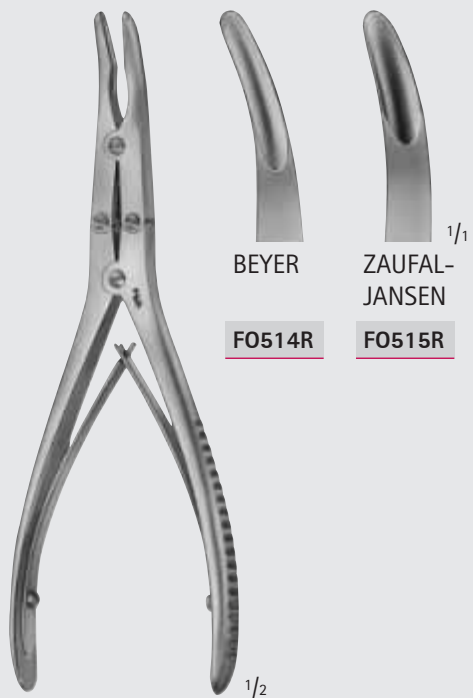

BEYER **ZAUFAL-
JANSEN** ^{1/1}
FO514R **FO515R**

FO514R-FO515R
180 mm, 7"



RUSKIN
FO518R
190 mm, 7 1/2"



RÖTTGEN-RUSKIN
FO521R
240 mm, 9 1/2"



Knochenhaltezangen, Hohlmeißelzangen – Bone Holding Forceps, Bone Rongeurs
 Hohlmeißelzangen
 Bone Rongeurs

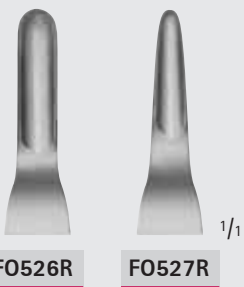

FO526R

FO527R



LEKSELL

FO526R-FO527R

245 mm, 9 3/4"



FO522R

FO523R



ECHLIN

FO522R-FO523R

230 mm, 9"



FRYKHOLM

FO525R

240 mm, 9 1/2"

FO

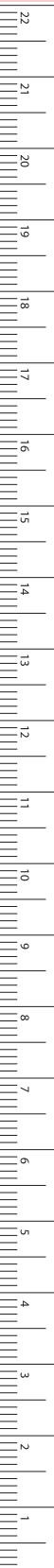

MILLIMETERS

Knochenhaltezangen, Hohlmeißelzangen – Bone Holding Forceps, Bone Rongeurs

Hohlmeißelzangen

Bone Rongeurs

FO



STILLE

FO530R

230 mm, 9"



LEKSELL-STILLE

FO532R

240 mm, 9 1/2"

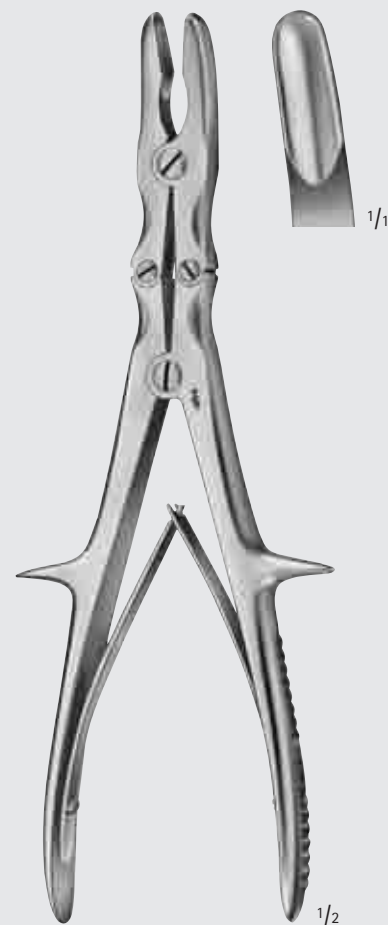

STILLE-RUSKIN

FO534R

240 mm, 9 1/2"



Knochenhaltezangen, Hohlmeißelzangen – Bone Holding Forceps, Bone Rongeurs

Hohlmeißelzangen
Bone Rongeurs

FO

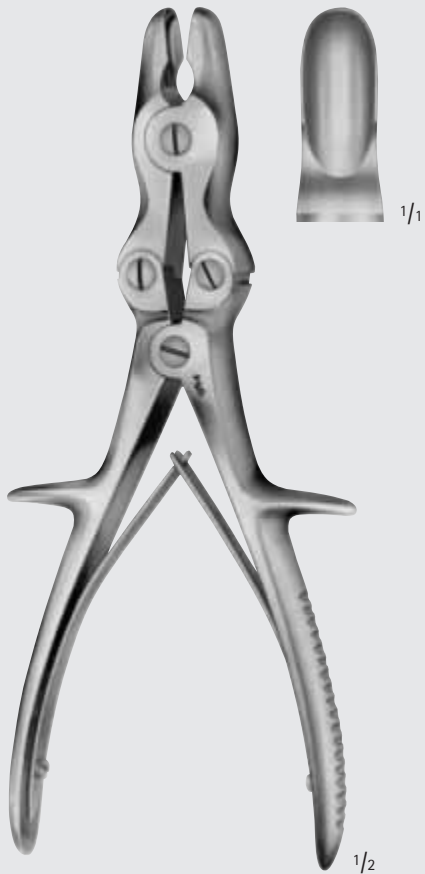

LUER-STILLE

FO550R

225 mm, 9"

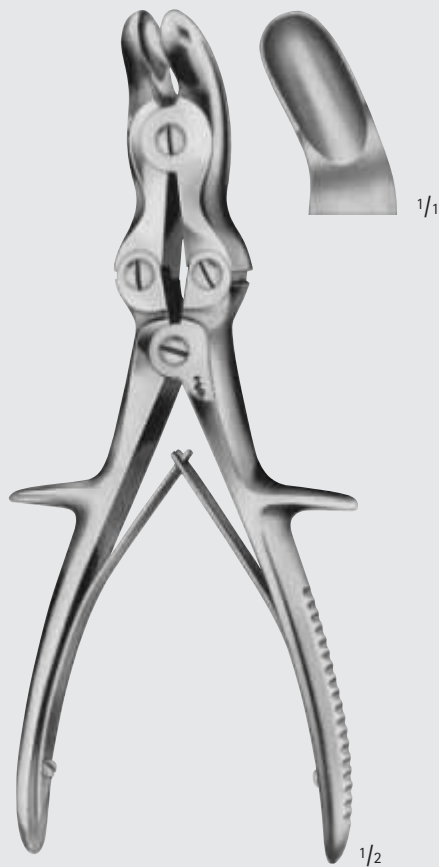

LUER-STILLE

FO551R

225 mm, 9"



SYPERT

FG052R

360 mm, 14 1/2"



MILLIMETERS

Knochenhaltezangen, Hohlmeißelzangen – Bone Holding Forceps, Bone Rongeurs

Hohlmeißelzangen

Bone Rongeurs

FO



LUER-STILLE

FO566R

270 mm, 10 3/4"



SEMB

FO555R

240 mm, 9 1/2"



Knochenhaltezangen, Hohlmeißelzangen – Bone Holding Forceps, Bone Rongeurs
Hohlmeißelzangen
Bone Rongeurs

FO

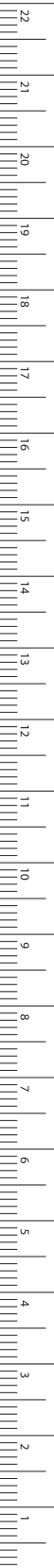

MILLIMETERS



1/2



FO570R



FO572R

1/1

SAUERBRUCH-CORYLLOS

FO570R-FO572R

310 mm, 12 3/8"

Knochenhaltezangen, Hohlmeißelzangen – Bone Holding Forceps, Bone Rongeurs
 Knochensplitterzangen
 Bone Cutting Forceps

FO

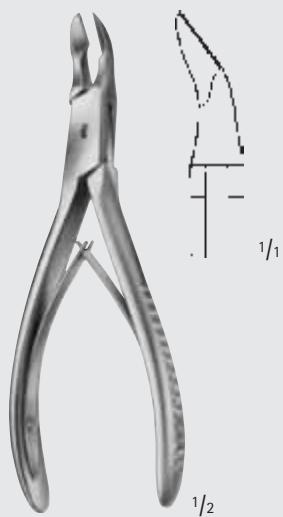

FO601R

130 mm, 5 1/8"

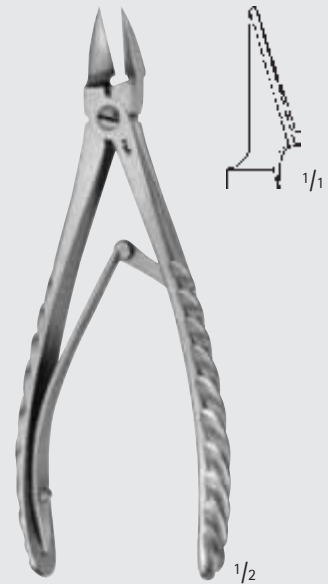

STAMM

FO604R

150 mm, 6"

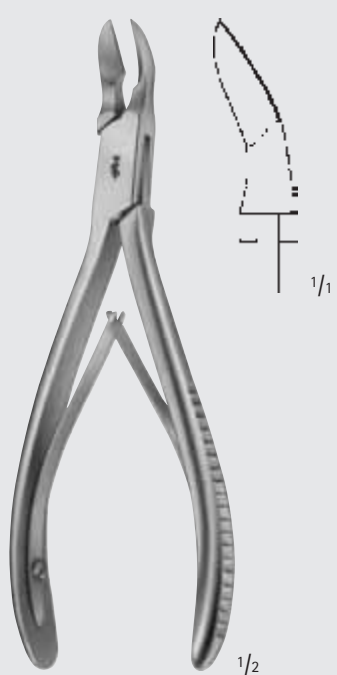

FO602R

170 mm, 6 3/4"

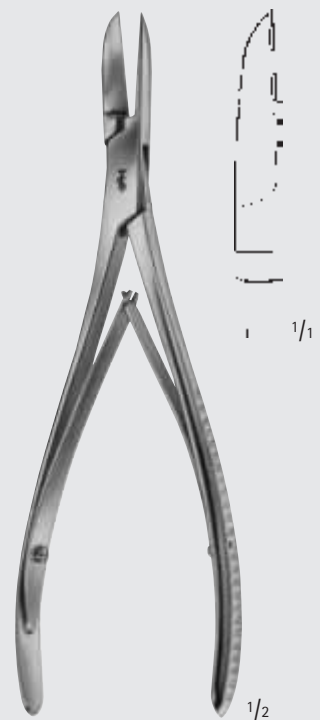

KAZANJIAN

OK378R

185 mm, 7 1/2"



Knochenhaltezangen, Hohlmeißelzangen – Bone Holding Forceps, Bone Rongeurs

Knochensplitterzangen Bone Cutting Forceps

FO

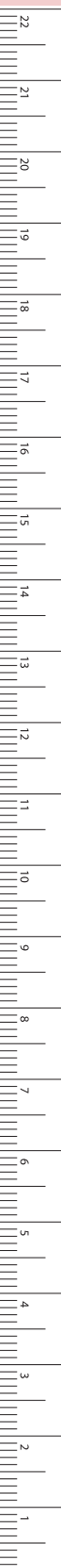

MILLIMETERS

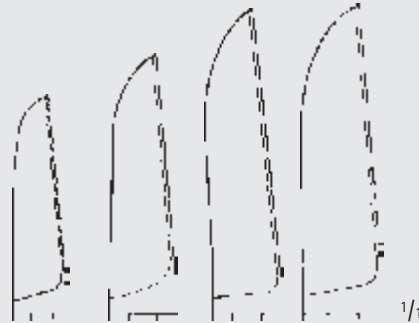

FO620R	FO622R	FO624R	FO626R
140 mm	170 mm	200 mm	220 mm
5 1/2"	6 3/4"	8"	8 3/4"

LISTON

FO620R-FO626R



FO632R	FO634R	FO636R
170 mm	200 mm	220 mm
6 3/4"	8"	8 3/4"

LISTON

FO632R-FO636R

Knochenhaltezangen, Hohlmeißelzangen – Bone Holding Forceps, Bone Rongeurs

Knochensplitterzangen

Bone Cutting Forceps

FO



BÖHLER

FO610R

145 mm, 5 3/4"



BÖHLER

FO611R

145 mm, 5 3/4"



FO612R

170 mm, 6 3/4"

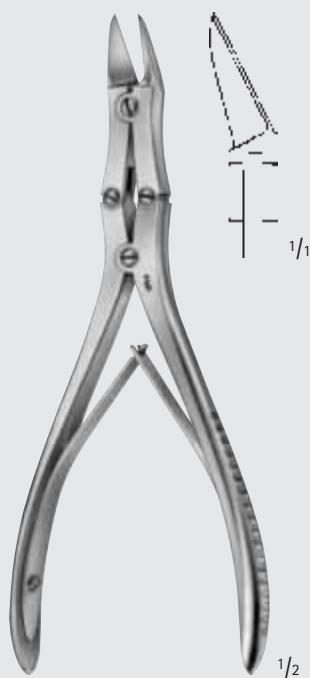

MC INDOE

FO614R

175 mm, 7"

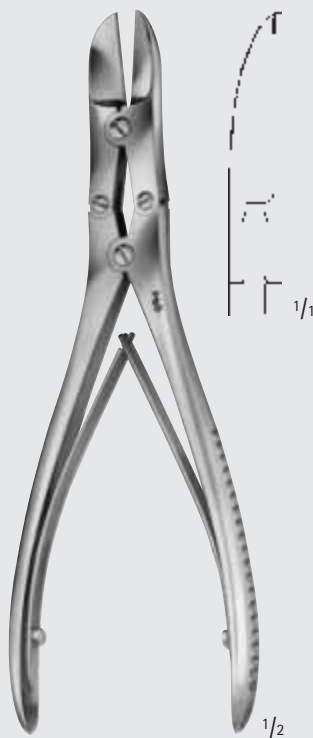

RUSKIN-LISTON

FO640R

190 mm, 7 1/2"

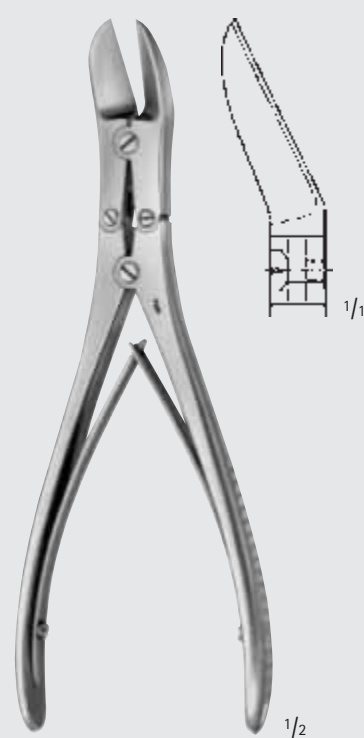

RUSKIN-LISTON

FO641R

190 mm, 7 1/2"



Knochenhaltezangen, Hohlmeißelzangen – Bone Holding Forceps, Bone Rongeurs
 Knochensplitterzangen
 Bone Cutting Forceps

FO

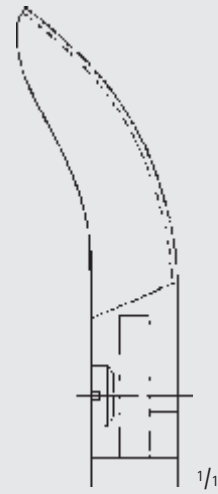
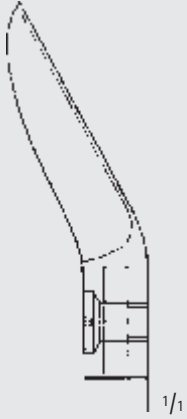
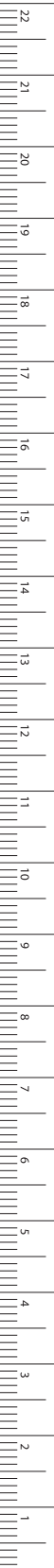

LISTON

FO645R

aufgebogen
 curved on flat
 240 mm, 9 1/2"

LISTON

FO646R

gerade
 straight
 280 mm, 11"

LISTON

FO647R

aufgebogen
 curved on flat
 280 mm, 11"

Knochenhaltezangen, Hohlmeißelzangen – Bone Holding Forceps, Bone Rongeurs
 Knochensplitterzangen
 Bone Cutting Forceps

FO

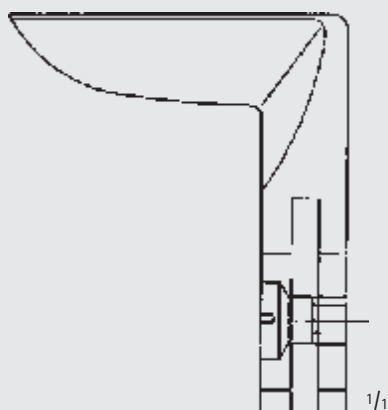

LISTON-STILLE

FO648R

265 mm, 10 1/2"

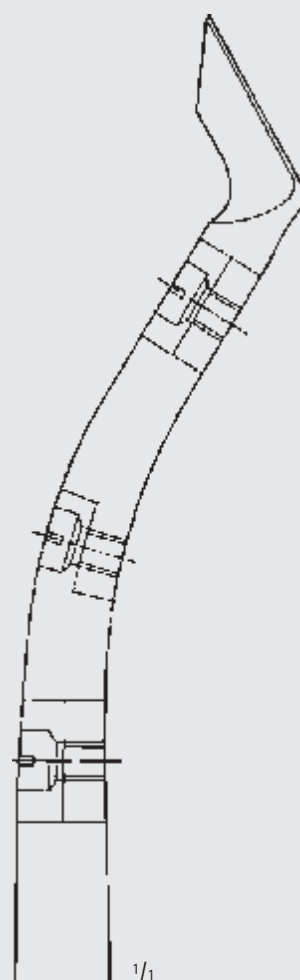

LISTON-KEY-HORSLEY
 (TUDOR EDWARDS)

FO649R

255 mm, 10"



Knochenhaltezangen, Hohlmeißelzangen – Bone Holding Forceps, Bone Rongeurs

Meniskus- und Knorpelzangen Meniscus- and Cartilage Forceps

FO

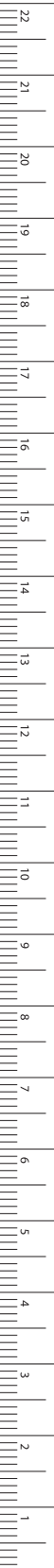



1/2

1/1

BIRCHER

FO800R

200 mm, 8"





1/2

1/1

BIRCHER

FO801R

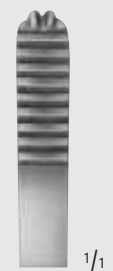
200 mm, 8"



1/2

1/1

WELLER

FO807R

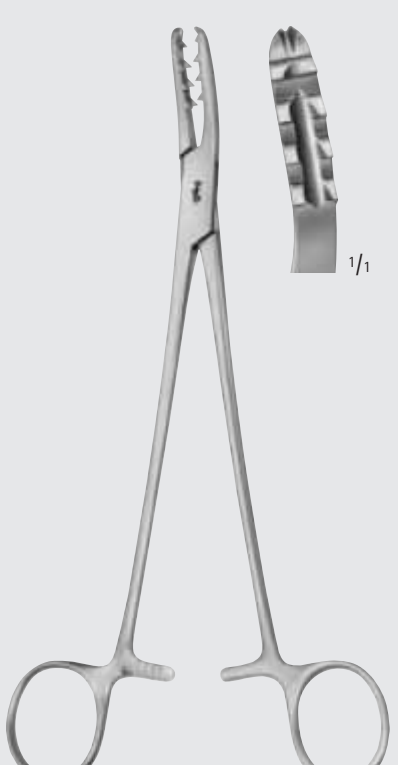
200 mm, 8"



1/2

1/1

BIRCHER-GANSKE

FO808R

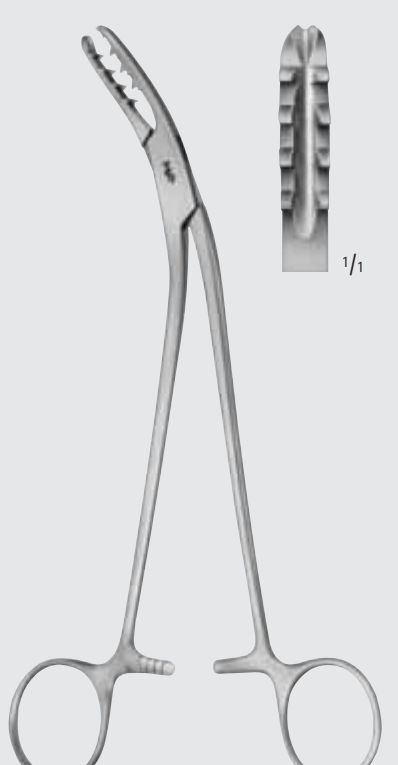
200 mm, 8"



1/2

1/1

BIRCHER-GANSKE

FO810R

200 mm, 8"

1/2

1/1

MARTIN

FO816R

205 mm, 8"

Knochenhaltezangen, Hohlmeißelzangen – Bone Holding Forceps, Bone Rongeurs

Meniskusmesser

Meniscus Knives

FO

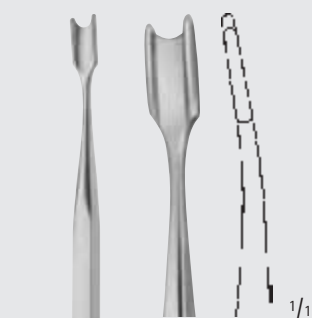

1
SMILLIE

FO855R

170 mm, 6 3/4"

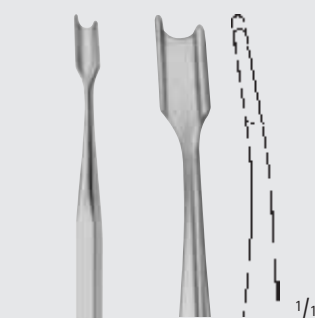

2
SMILLIE

FO856R

170 mm, 6 3/4"

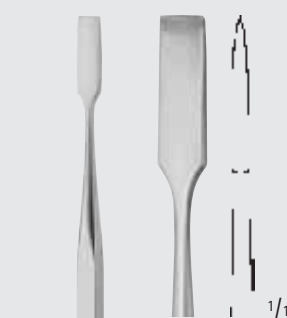

3
SMILLIE

FO857R

170 mm, 6 3/4"



Knochenhaltezangen, Hohlmeißelzangen – Bone Holding Forceps, Bone Rongeurs

Wund- und Meniskushaken Retractors and Knee Retractors

FO

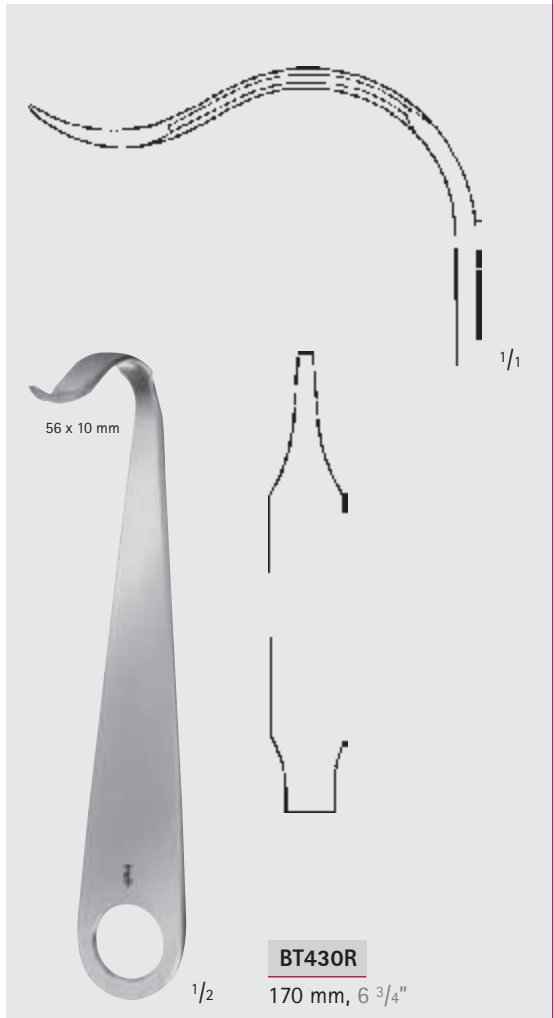
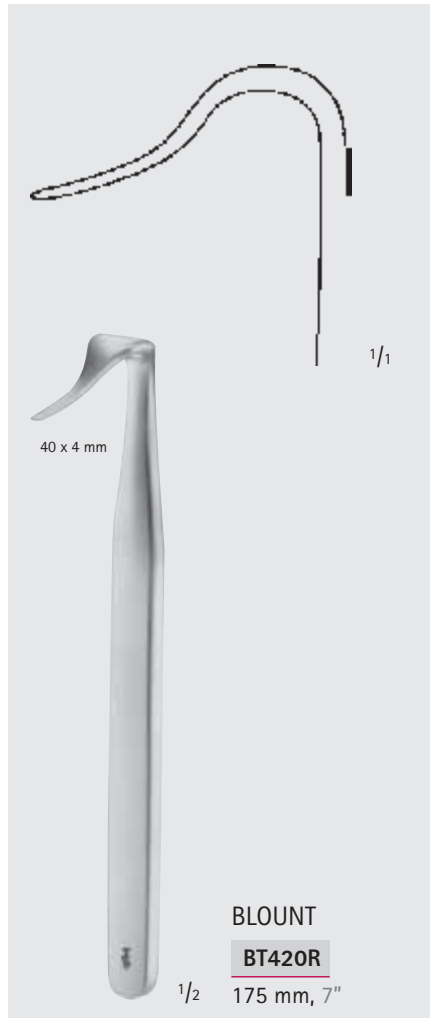
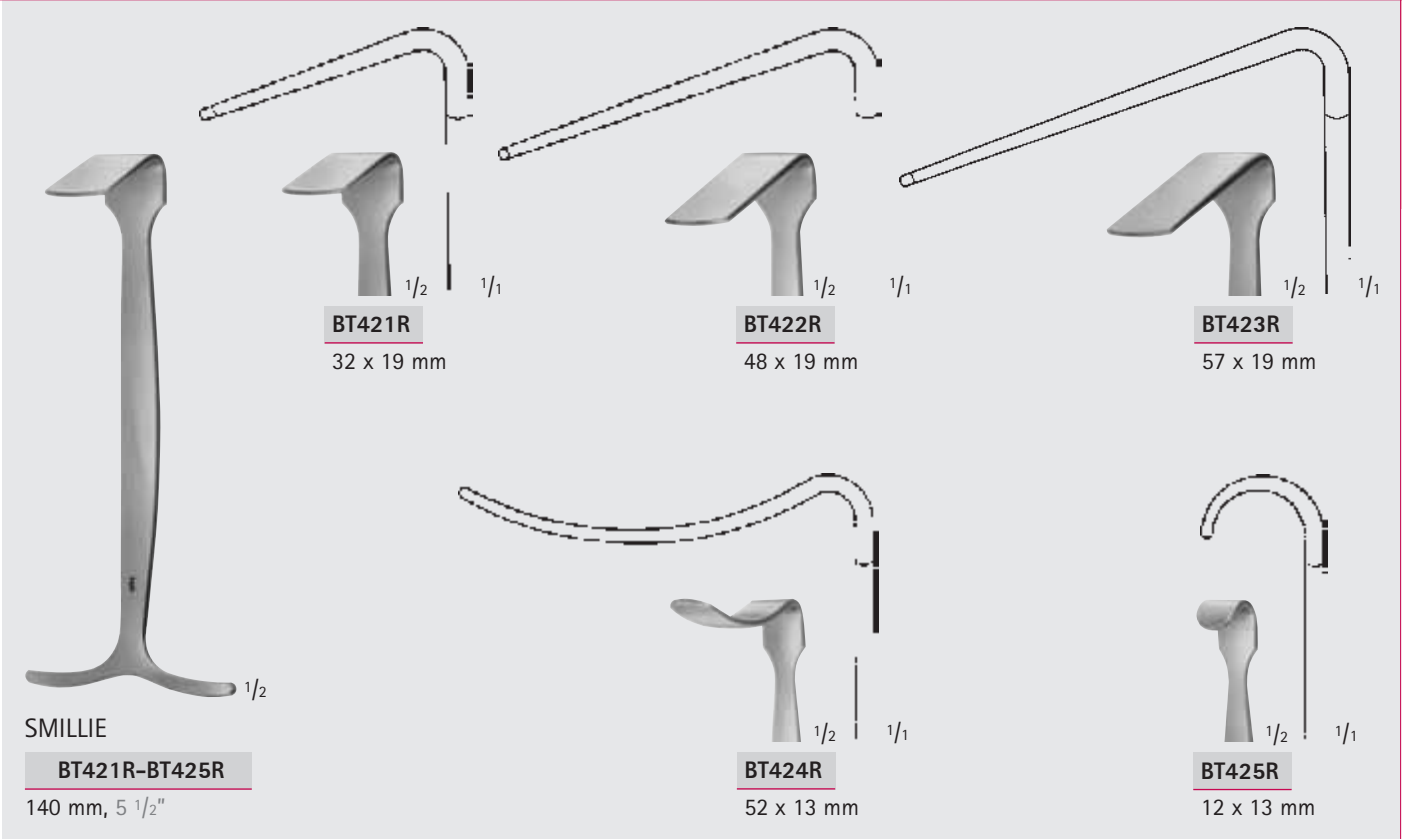
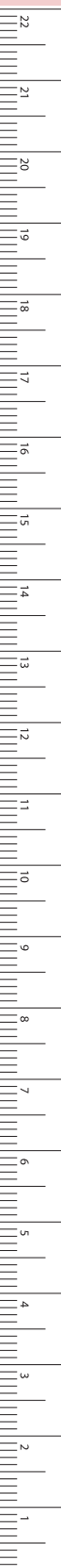

Knochenhaltezangen, Hohlmeißelzangen – Bone Holding Forceps, Bone Rongeurs

Sehnenstripper

Tendon Strippers

FO

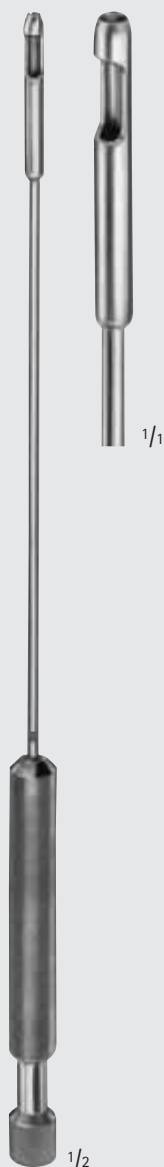

1/1

1/2

Ø
diam.

FO923R 3 mm

Sehnenstripper
Schaftlänge: 190 mm
Tendon stripper
Shaft length: 7 1/2"
300 mm, 11 1/2"

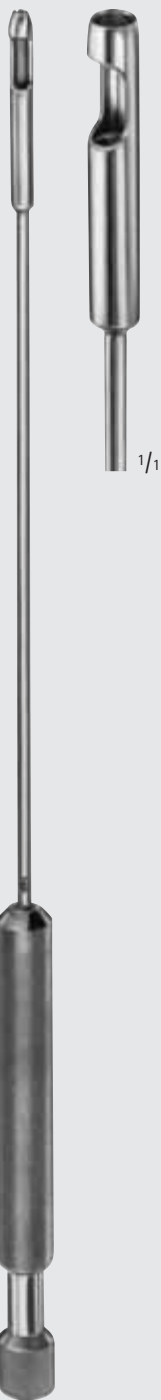

1/1

Ø
diam.

FO925R 5 mm

Sehnenstripper
Schaftlänge: 390 mm
Tendon stripper
Shaft length: 15 1/3"
495 mm, 19 1/2"

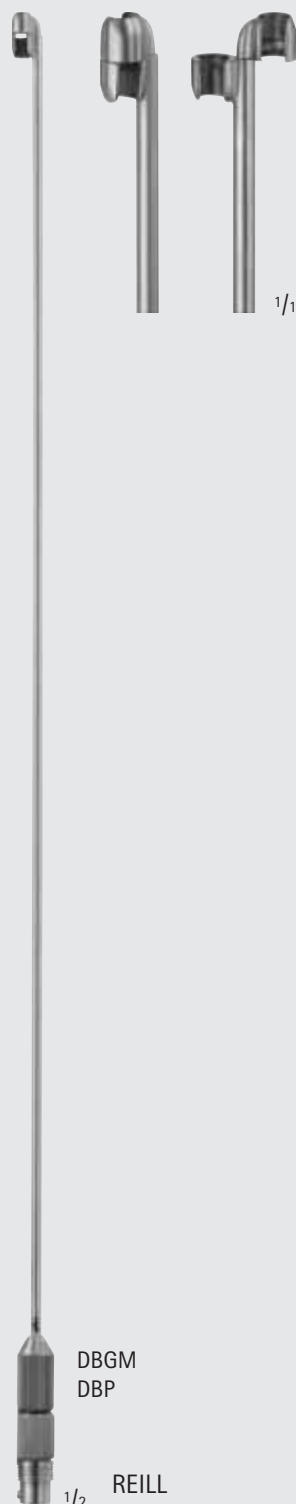

1/1

DBGM
DBP

REILL

1/2

Ø
diam.

FO928R 4 mm

FO930R 6 mm

Sehnenstripper
Schaftlänge: 350 mm
Tendon stripper
Shaft length: 13 3/4"
395 mm, 15 1/2"

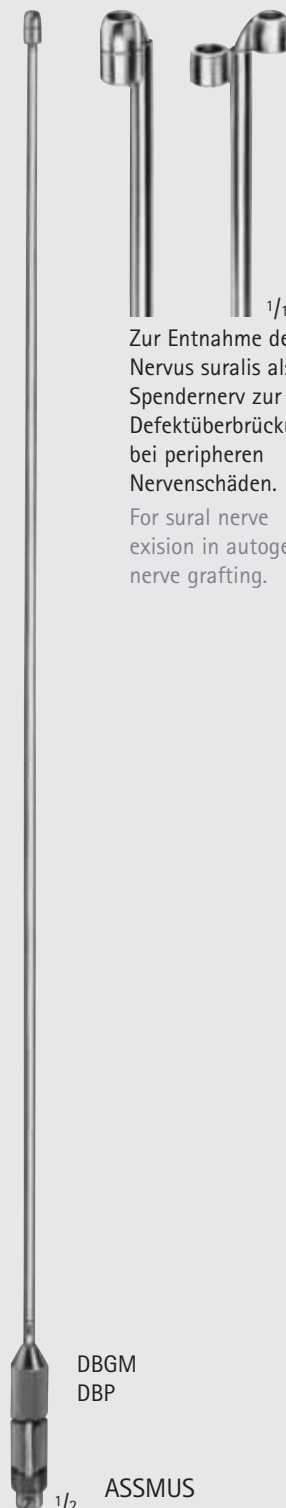

1/1

DBGM
DBP

ASSMUS

1/2

Ø
diam.

FD610R 3 mm

Nervenstripper, stumpf
Schaftlänge: 350 mm
Nerve stripper, blunt
Shaft length: 13 3/4"
395 mm, 15 1/2"

Zur Entnahme des
Nervus suralis als
Spendernerve zur
Defektüberbrückung
bei peripheren
Nervenschäden.

For sural nerve
exision in autogenous
nerve grafting.



Knochenhaltezangen, Hohlmeißelzangen – Bone Holding Forceps, Bone Rongeurs

Sehnenstripper
Tendon Strippers

FO



FO931R FO932R FO933R FO934R ^{1/1}



BRUNNELL

Ø
diam.

FO931R	2 mm
FO932R	3 mm
FO933R	4 mm
FO934R	6 mm

135 mm, 5 1/4"



FO935R

FO937R ^{1/1}

Ø
diam.

FO935R	3 mm
FO937R	5 mm

300 mm, 12"

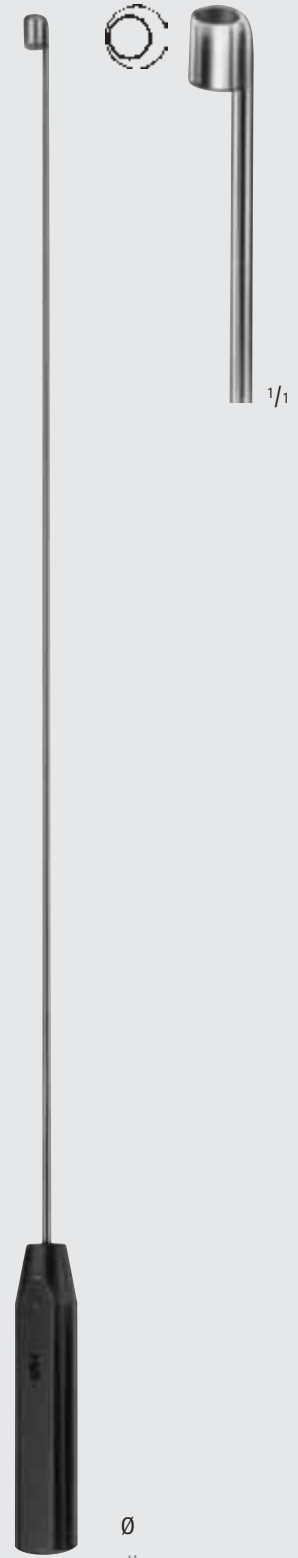

FO939R 5 mm

500 mm, 19 1/2"

Ø
diam.

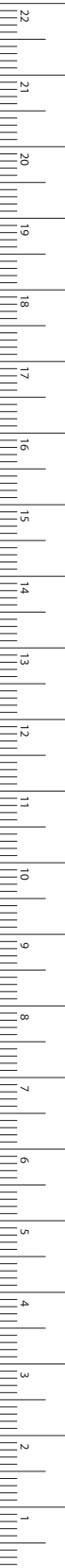

MILLIMETERS

Knochenhaltezangen, Hohlmeißelzangen – Bone Holding Forceps, Bone Rongeurs

Sehnedurchziehsonden

Tendon Passing Probes

FO



1/2

BUNNELL

FO940R

230 mm, 9"



1/2

Knopf-Ø
diam. of tip

BN034R 2,5 mm

145 mm, 5 3/4"



1/2

Knopf-Ø
diam. of tip

BN036R 2,5 mm

160 mm, 6 1/4"



1/2

Knopf-Ø
diam. of tip

BN040R 3,0 mm

200 mm, 8"

Knochenhaltezangen, Hohlmeißelzangen – Bone Holding Forceps, Bone Rongeurs
 Bleihände, Handfixierplatte
 Lead Hands, Hand Fixation Plate

FO

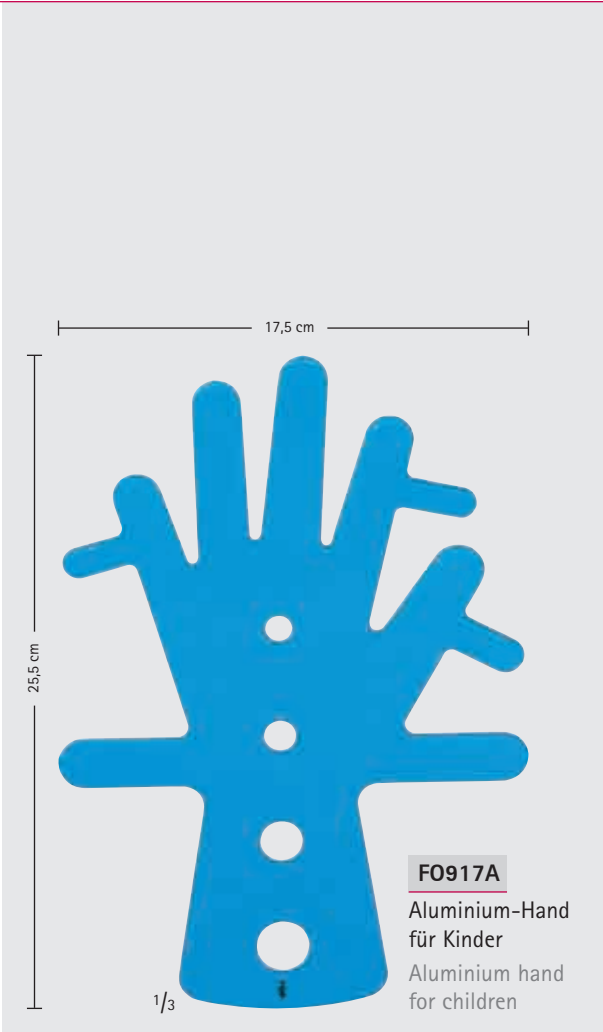

FO917A
 Aluminium-Hand
 für Kinder
 Aluminium hand
 for children



FO918A
 Aluminium-Hand
 für Erwachsene
 Aluminium hand
 for adults



FO912R
 Handfixierplatte komplett
 mit 5 Fingerklammern
 Hand fixation plate complete
 with 5 finger clips



FO913R
 Fingerklammer zu FO912R
 Fingerclip for FO912R



MILLIMETERS

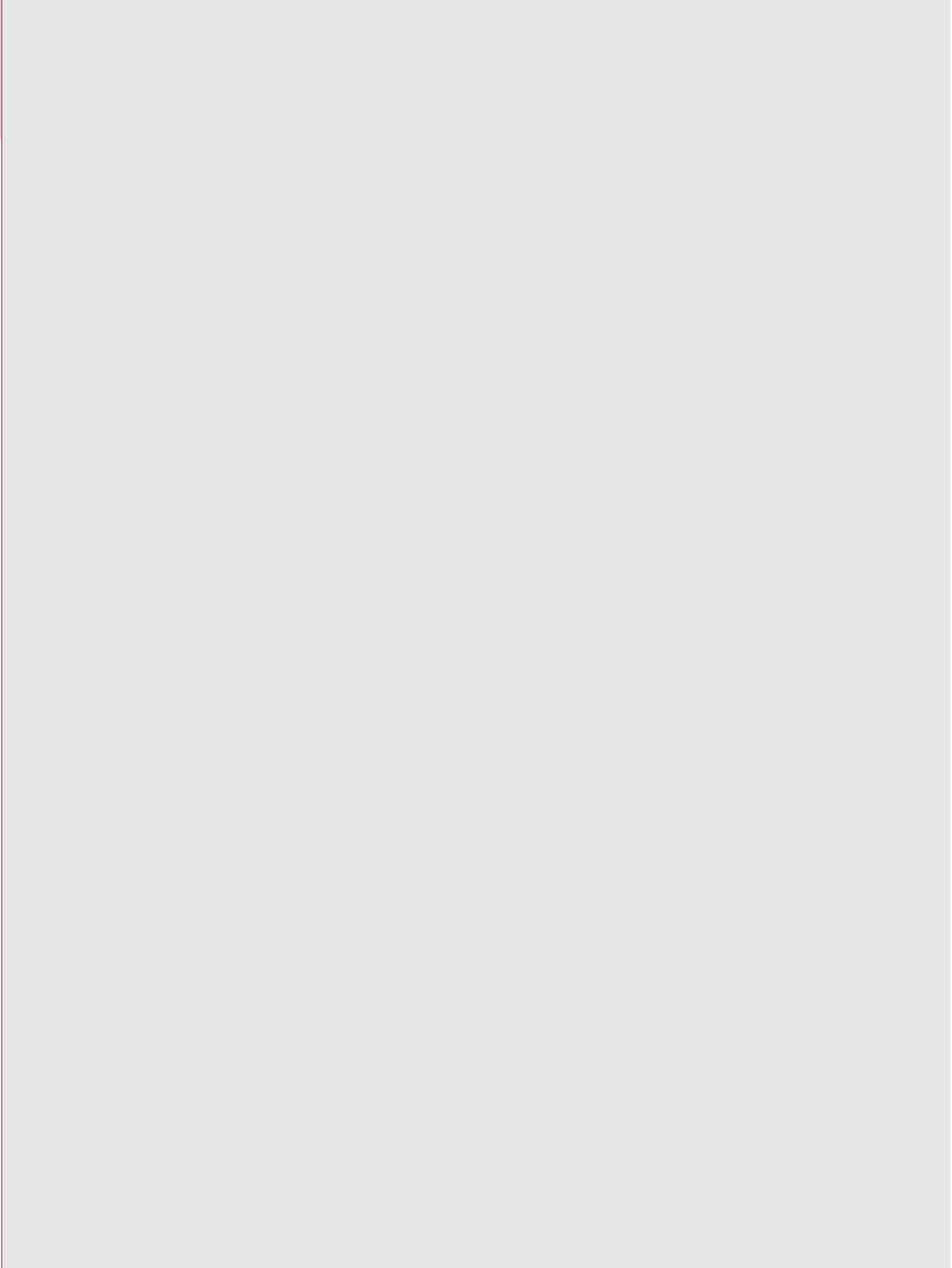



LX



**Drahtextension, Handbohrapparate,
Ahlen, Pfrieme**
Wire Extension, Hand Drills, Awls

Drahtextension – Wire extension

Handbohrapparat
Hand Drill



FF057R

Verlängerungsstück allein
Extension piece only

FF056R

Bogen allein
Brace only

HUDSON

FF055R

Handbohrapparat komplett,
bestehend aus:

- FF056R Bogen
- FF057R Verlängerungsstück
- FF061R Fräser
- FF062R Fräser
- FF063R Fräser
- FF064R Fräser

Hand drill complete,
consisting of:

- FF056R Brace
- FF057R Extension piece
- FF061R Burr
- FF062R Burr
- FF063R Burr
- FF064R Burr

Bohrer und Fräser auf dieser Seite passen auf FF056R und FF057R.
Achtung: Nicht passend für den Handbohrapparat HUDSON DOWNS
auf Seite 1053.

Perforators and burrs on this page fit onto FF056R and FF057R.
Attention: Does not fit onto the hand drill HUDSON DOWNS
on page 1053.

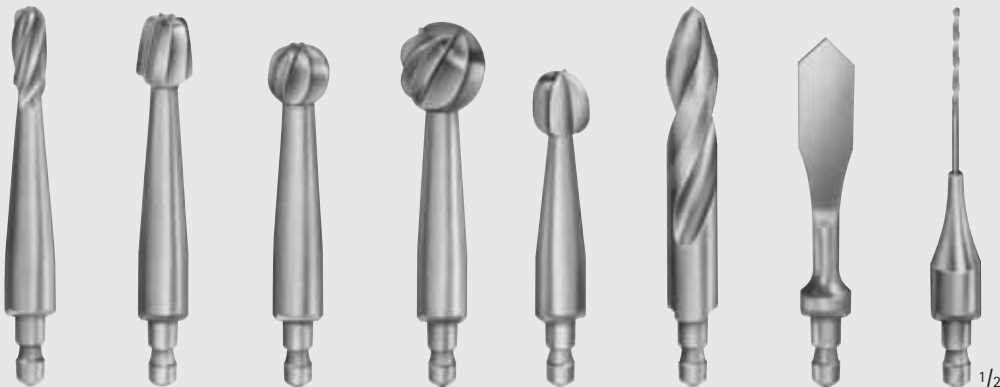

HUDSON

HUDSON

HUDSON

HUDSON

ADSON

MC KENZIE

CUSHING

FF061R

FF062R

FF063R

FF064R

FF065R

FF066R

FF067R

FF068R

Ø 9 mm

Ø 14 mm

Ø 16 mm

Ø 22 mm

Ø 15 mm

Ø 13 mm

Ø 14 mm

Ø 2 mm



Drahtension – Wire extension
Handbohrapparat
Hand Drill

X7



HUDSON DOWNS

FF052R

Bogen
Brace



HUDSON DOWNS

FF053R

Verlängerungsstück
Extension piece



HUDSON
DOWNS

FF031R

Ø 10 mm



HUDSON
DOWNS

FF032R

Ø 12 mm



HUDSON
DOWNS

FF033R

Ø 15 mm



HUDSON
DOWNS
(LEWIS)

FF034R

Ø 10 mm



HUDSON
DOWNS
(LEWIS)

FF035R

Ø 12 mm



HUDSON
DOWNS
(LEWIS)

FF036R

Ø 15 mm

Bohrer und Fräser auf dieser Seite passen auf FF052R und FF053R.
Achtung: Nicht passend für den Handbohrapparat HUDSON auf Seite 1052.

Perforators and burrs on this page fit FF052R and FF053R.
Attention: Does not fit onto the hand drill HUDSON on page 1052.



HUDSON
DOWNS

FF037R

Ø 11 mm



HUDSON
DOWNS

FF038R

Ø 13 mm



HUDSON
DOWNS

FF039R

Ø 16 mm



HUDSON
DOWNS

FF040R

Ø 11 mm



HUDSON
DOWNS

FF041R

Ø 13 mm



HUDSON
DOWNS

FF042R

Ø 16 mm



HUDSON
DOWNS

FF043R

Ø 19 mm



HUDSON
DOWNS

FF044R

Ø 22 mm



MC KENZIE

FF048R

Ø 16 mm



MC KENZIE

FF047R



MILLIMETERS

Drahtextension – Wire extension

Handbohrapparate, Spiralbohrer

Hand Drills, Twist Drills



BUNNELL

FR005R

Bohrapparat, kleines Modell, längsdurchbohrt, für Spickdrähte, mit 3-Backen-Spannfutter für Schäfte bis Ø 4,0 mm.

Small hand drill, cannulated for KIRSCHNER wires, with 3-jaw chuck, to fit any size of shanks up to 4.0 mm diameter

160 mm, 6 1/4"

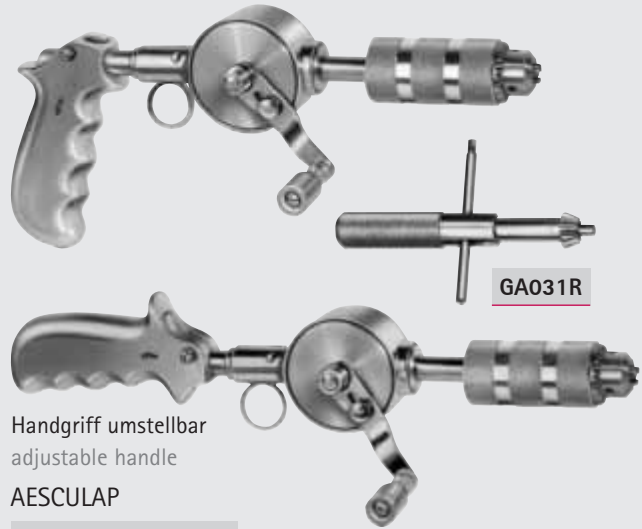

Handgriff umstellbar
adjustable handle

AESCULAP

FR011R

Handbohrapparat, wie FR010R, jedoch mit Original "Jacobs Chuck" (3-Backen-Spannfutter) und Spannschlüssel GA031R, Bedienung mit und ohne Spannschlüssel möglich.

Hand drill, stainless, as FR010R, but equipped with an original "Jacobs Chuck" and key GA031R. Can be used with or without the key.

280 mm, 11"

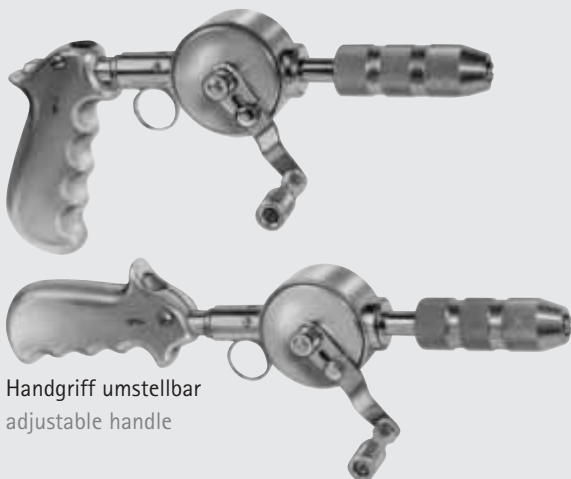

Handgriff umstellbar
adjustable handle

AESCULAP

FR010R

Handbohrapparat, nichtrostend, mit schlüssellosem 3-Backen-Spannfutter für Schäfte bis Ø 6,35 mm.

Spindel ist längsdurchbohrt zum Einspannen von Bohrdrähten n. KIRSCHNER. Mit Stoppvorrichtung für Kurbel während dem Spannen.

Hand drill, stainless, with 3-jaw chuck, to fit any size of shanks up to 6.35 mm diameter, no key needed. Cannulated spindle to fit KIRSCHNER wire drills. With stop device, for locking the spindle and crank when fitting and changing drills.

260 mm, 10 1/4"

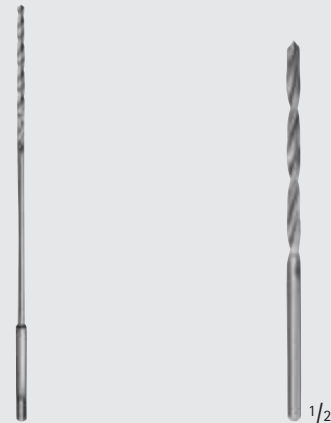

Ø diam	3-Kant-Schaft Triangular shaft	Länge* mm Length* mm	Rundschaft Round shaft	Länge* mm Length* mm
1,0 mm				
1,5 mm			GC002R	70/40 mm
2,0 mm			GC004R	100/50 mm
2,5 mm	GC391R	175/135 mm	GC006R	100/50 mm
2,8 mm			GC007R	100/50 mm
3,0 mm			GC008R	100/60 mm
3,2 mm			GC009R	100/60 mm
3,5 mm	GC395R	210/170 mm	GC010R	100/60 mm
4,0 mm			GC012R	110/70 mm
4,5 mm	GC397R	210/170 mm	GC013R	150/80 mm
5,0 mm			GC014R	160/90 mm
6,0 mm			GC016R	160/90 mm

*Gesamtlänge/Nutzlänge

*Total length/Usable length

LX





Drahtension – Wire extension
Knochenbohrer, Ahlen
Bone Drills, Awls

X1



CHAMPIONNIÈRE

FR110R

Knochenbohrer
Bone drill
170 mm, 6 3/4"

1/2



FR118R

Reibahle
Reamer (Awl)
150 mm, 6"

1/2

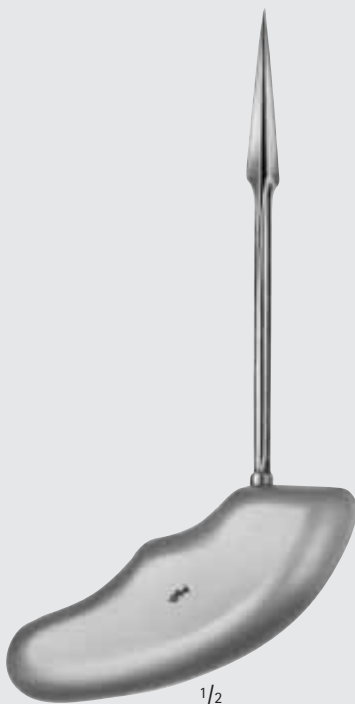

FR120R

Reibahle
Reamer (Awl)
180 mm, 7"

1/2



PERTHES

FR125R

Reibahle
Reamer (Awl)
215 mm, 8 1/2"

1/2

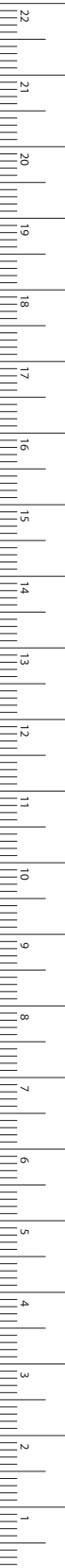

MILLIMETERS

Drahtextension – Wire extension

Unterbindungsnadeln

Ligature Needles

LX



OBWEGESER

DO811R

230 mm, 9"



OBWEGESER

DO812R

195 mm, 7 3/4"

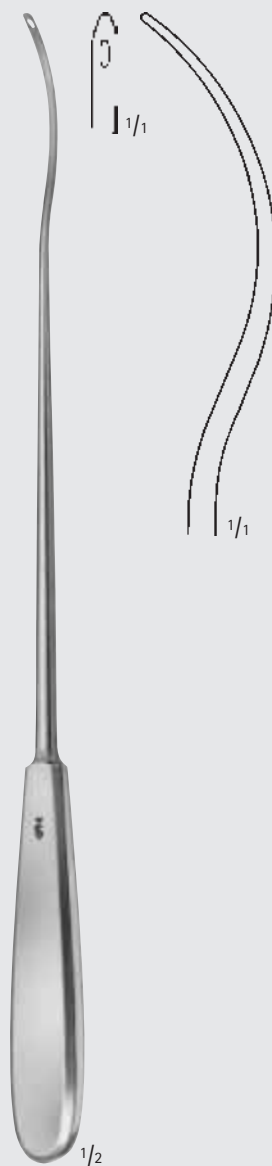

BRUNNER

BM831R

300 mm, 12"

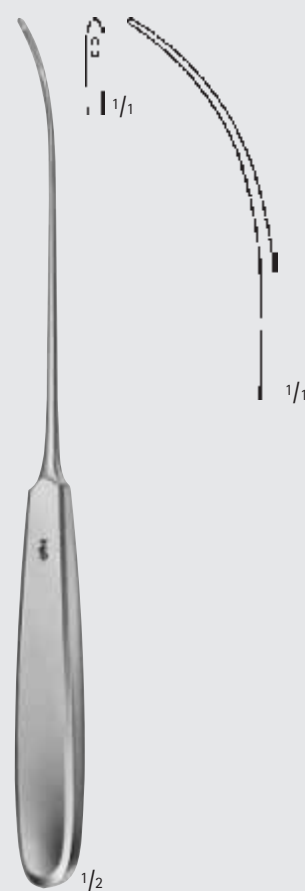

biegsam
malleable
230 mm, 9"



Drahtension – Wire extension

Biopsie-Instrumente Biopsy Instruments

Auch sehr gut geeignet zum Freilegen von abgebrochenen Knochenschrauben.
Can also be used for removal of broken bone screws.



FR140R

Innen-Ø 3,9 mm
Außen-Ø 5 mm
inside-diam. 3.9 mm
outside-diam. 5 mm



FR141R

Innen-Ø 6,4 mm
Außen-Ø 8 mm
inside-diam. 6.4 mm
outside-diam. 8 mm

FR140R-FR141R

Knochenbiopsie-Instrument
Hollow mills (bone biopsy trephine)
160 mm, 6 1/4"

1/2



1/1

Innen-Ø 6,7 mm
Außen-Ø 8,7 mm
inside-diam. 6.7 mm
outside-diam. 8.7 mm

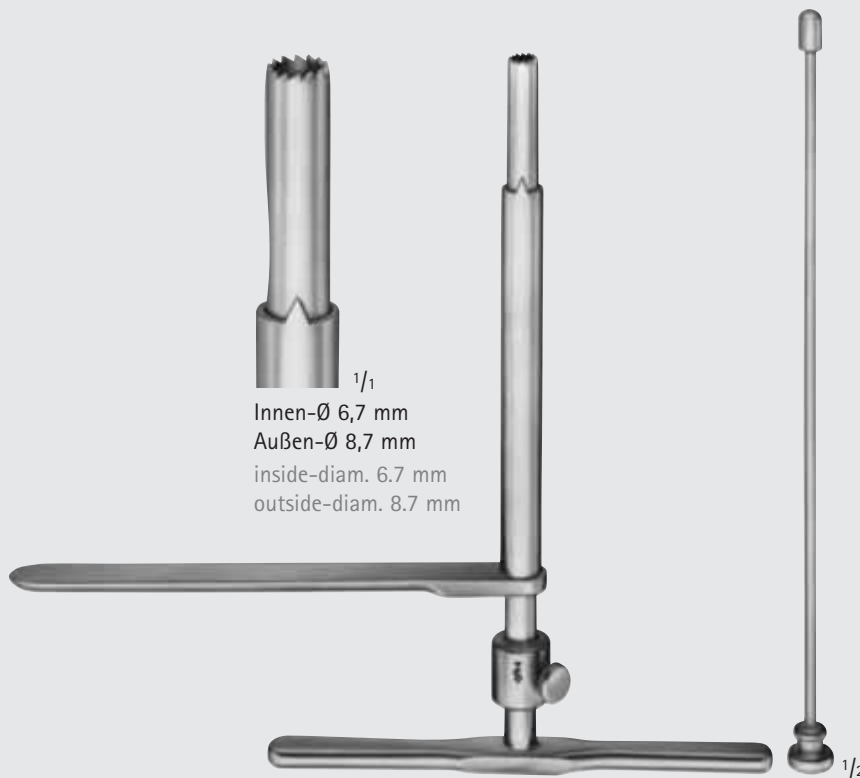

1/2

R.N.O.H.

FR142R

Knochenbiopsie-Instrument
Bone biopsy trephine
195 mm, 7 3/4"

X1

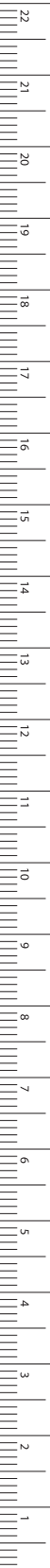

MILLIMETERS

Drahtextension – Wire extension

Drahtextension

Wire Extension

Implantatwerkstoff: Nichtrostender Stahl nach DIN 17 443 bzw. ISO 5832/I (AISI 316 L)

Material used for implants: stainless steel acc. to DIN 17 443 resp. ISO 5832/I (AISI 316 L)

mit beidseitiger
Trokarspitze
with trocar point
on each end



KIRSCHNER

LX901S-LX957S

Ø diam.	102 mm 4"	127 mm 5"	152 mm 6"	229 mm 9"	305 mm 12"
0,8 mm	LX901S	LX902S			
0,9 mm	LX911S	LX912S	LX913S	LX915S	LX917S
1,0 mm					
1,1 mm	LX921S	LX922S	LX923S	LX925S	LX927S
1,2 mm					
1,4 mm					
1,5 mm					
1,6 mm	LX951S	LX952S	LX953S	LX955S	LX957S
1,7 mm					
1,8 mm					
2,0 mm					
2,2 mm					
2,5 mm					
3,0 mm					

mit Trokarspitze
with trocar point

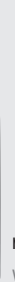

mit flachem Ende
with flat shaft

KIRSCHNER

LX008S-LX025S

310 mm, 12"

Ø diam.	
0,8 mm	LX008S
0,9 mm	
1,0 mm	LX010S
1,1 mm	
1,2 mm	LX012S
1,4 mm	LX014S
1,5 mm	LX015S
1,6 mm	LX016S
1,7 mm	LX017S
1,8 mm	LX018S
2,0 mm	LX020S
2,2 mm	LX022S
2,5 mm	LX025S
3,0 mm	

mit Trokarspitze
with trocar point



mit rundem Ende
with round shaft

KIRSCHNER

LX030S-LX047S

Form nach DIN 58 823
Type acc. to DIN 58 823
310 mm, 12"

Ø diam.	
0,8 mm	LX030S
0,9 mm	
1,0 mm	
1,1 mm	
1,2 mm	LX032S
1,4 mm	LX034S
1,5 mm	LX035S
1,6 mm	LX036S
1,7 mm	
1,8 mm	LX038S
2,0 mm	LX040S
2,2 mm	LX042S
2,5 mm	LX045S
3,0 mm	LX047S

Bestelleinheit: **PAK** = Packung à 10 Stück
Sales unit: Package of 10 pieces



Drahtextension – Wire extension

Drahtextension

Wire Extension

Implantatwerkstoff: Nichtrostender Stahl nach DIN 17 443 bzw. ISO 5832/I (AISI 316 L)

Material used for implants: stainless steel acc. to DIN 17 443 resp. ISO 5832/I (AISI 316 L)

mit Trokarspitze
with trocar point



mit rundem Ende
with round shaft

KIRSCHNER

LX098S-LX100S

70 mm, 2 3/4"

Ø diam.	
0,8 mm	LX098S
1,0 mm	LX100S
1,2 mm	
1,4 mm	
1,5 mm	
1,6 mm	
1,7 mm	
1,8 mm	
2,0 mm	
2,2 mm	
2,5 mm	
3,0 mm	

mit Trokarspitze
with trocar point



mit flachem Ende
with flat shaft

KIRSCHNER

LX108S-LX125S

Form nach DIN 58 823
Type acc. to DIN 58 823
150 mm, 6"

Ø diam.	
0,8 mm	LX108S
1,0 mm	LX110S
1,2 mm	LX112S
1,4 mm	LX114S
1,5 mm	LX115S
1,6 mm	LX116S
1,7 mm	LX117S
1,8 mm	LX118S
2,0 mm	LX120S
2,2 mm	LX122S
2,5 mm	LX125S
3,0 mm	

mit Trokarspitze
with trocar point

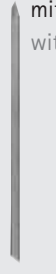

mit rundem Ende
with round shaft

KIRSCHNER

LX128S-LX146S

Form nach DIN 58 823
Type acc. to DIN 58 823
150 mm, 6"

Ø diam.	
0,8 mm	LX128S
1,0 mm	LX130S
1,2 mm	LX132S
1,4 mm	LX134S
1,5 mm	LX135S
1,6 mm	LX136S
1,7 mm	LX137S
1,8 mm	LX138S
2,0 mm	LX140S
2,2 mm	LX142S
2,5 mm	LX145S
3,0 mm	LX146S

Biegeinstrumente
für Bohrdrähte
Bending iron for
boring wires

Dampfsterilisierbar
bis 143 °C (3 bar)
Can be sterilized
in a steam sterilizer
up to 143 °C
(3 bar)



WAGNER

LX180S

bis Ø 3,0 mm
up to 3.0 mm
diam.

300 mm, 12"



1/2

LX175S

bis Ø 2,7 mm
up to 2.7 mm
diam.

120 mm, 4 3/4"

Bestelleinheit: **PAK** = Packung à 10 Stück
Sales unit: Package of 10 pieces

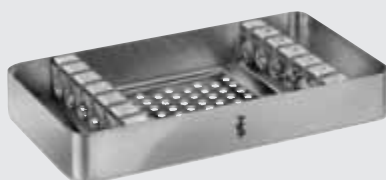

LX002R 170 x 92 x 25 mm

Sortiergestell für Fingerdrähte bis max. 165 mm Länge,
mit Kontroll-Lehre und Unterteilungen für Drähte mit
1,0 - 1,2 - 1,4 - 1,6 - 1,8 und 2,0 mm Ø.
Sterilizing rack for finger wires up to max. 165 mm long,
with measuring scale and compartments for wires with
1.0, 1.2, 1.4, 1.6, 1.8 and 2.0 mm diam.

X1

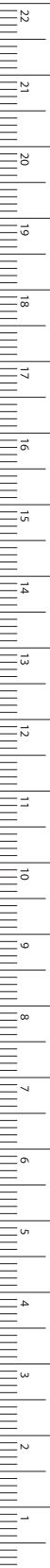

MILLIMETERS

Drahtextension – Wire extension

Drahtextension

Wire Extension

SW17

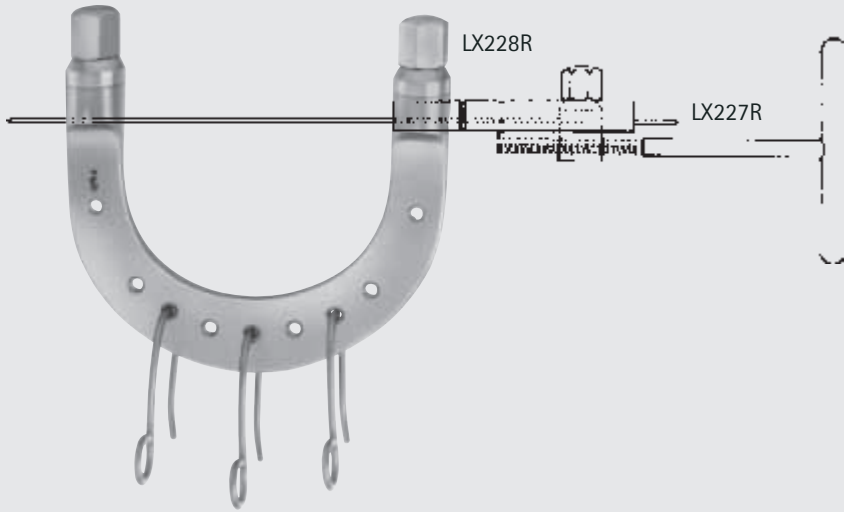

KIRSCHNER

LX211R-LX218R

Extensionsbügel, zur Verwendung mit KIRSCHNER-Drähten bis Ø 2,5 mm, mit 3 Zughaken, aus nichtrostendem Stahl
Wire traction bows, to be used with KIRSCHNER-wires up to 2.5 mm diam., with 3 hooks, stainless steel

Lichte Maße
Inside dimensions

	Weite Width	Tiefe Depth
--	----------------	----------------

	Weite Width	Tiefe Depth		
LX211R	200 mm, 8"	155 mm, 6"	für die Hüfte	for the hip
LX212R	155 mm, 6"	155 mm, 6"	für den Oberschenkel	for the femur
LX213R	135 mm, 5 1/4"	130 mm, 5 1/8"	für das Knie	for the knee
LX214R	120 mm, 4 3/4"	120 mm, 4 3/4"	für das Knie	for the knee
LX215R	105 mm, 4 1/8"	100 mm, 4"	für das Knie	for the knee
LX216R	95 mm, 3 3/4"	110 mm, 4 3/8"	für das Fersenbein	for the calcaneus
LX218R	95 mm, 3 3/4"	70 mm, 2 3/4"	für den Arm und Ellenbogen	for the arm and elbow

SW17

SW14



LX225C

Spannschlüssel für Extensionsbügel LX211R - LX242R
Wrench, double-ended, for wire traction bows LX211R - LX242R

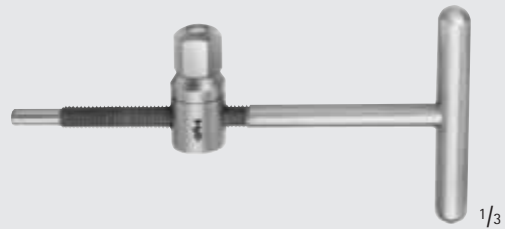

LX227R

Spannschlüssel mit Klemmbacke, zum Spannen des Drahtes
Wire tightener with clamping jaws



LX222R

Zughaken allein, großes Modell
Traction hook only, large size



LX223R

Zughaken allein, kleines Modell
Traction hook only, small size



LX228R

Fixierschlüssel zum Festhalten der Klemmschraube am Spannschlüssel LX227R
Fixation clamp, to secure clamping jaw of LX227R, stainless steel



Drahtextension – Wire extension

Drahtextension Wire Extension

X1

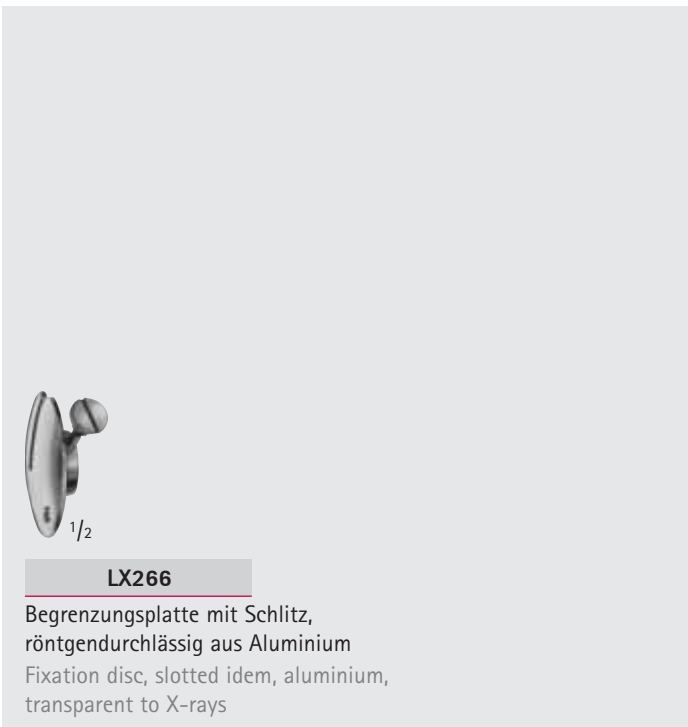
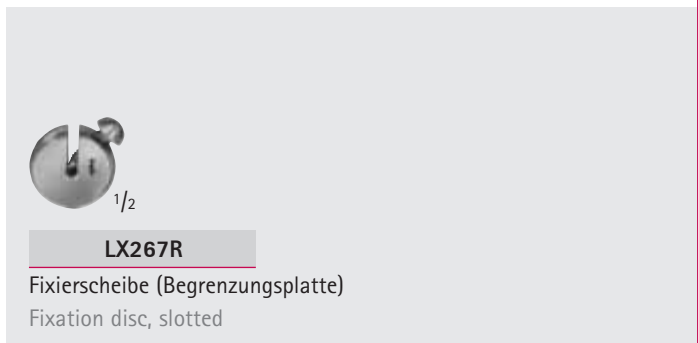
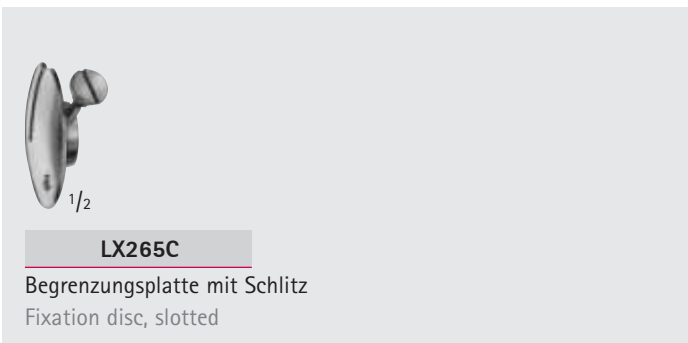
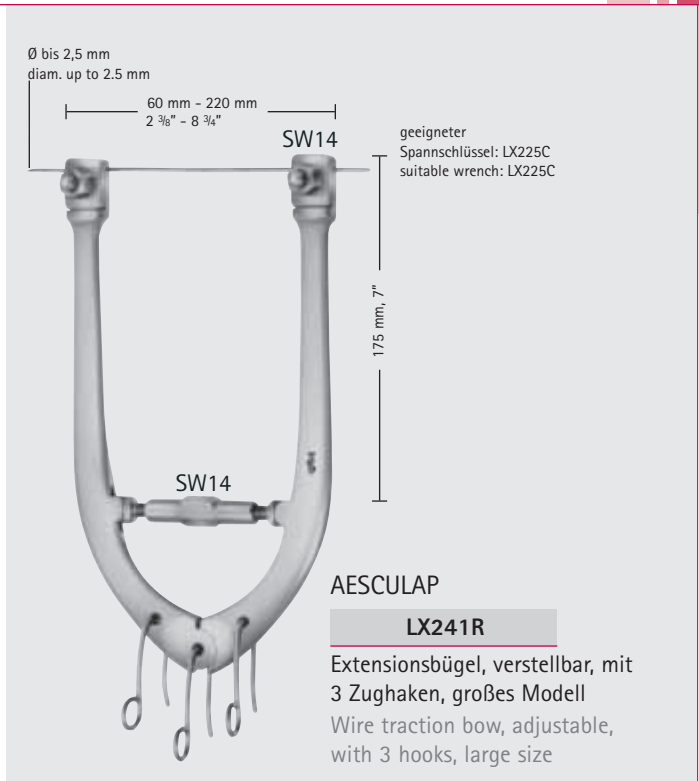
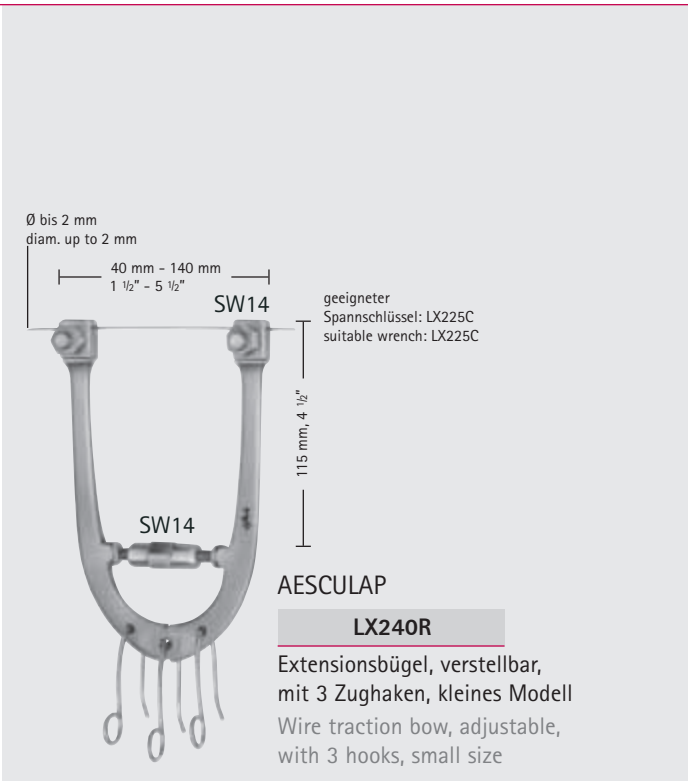

Drahtextension – Wire extension

Extensionsbügel, Distraktor

Traction Bows, Distractor



BÖHLER

LX204R-LX209R

Extensionsbügel,
zur Verwendung von
STEINMANN-Nägeln

Traction bows,
to be used with
STEINMANN pins

Ø diam.		Ø diam.		lichte Weite inside width	für for
4 mm		5 mm			
LX204R	mit Nagel KX115S with pin KX115S			16 x 9 cm 6 1/4" x 3 1/2"	Arm arm
LX205R	ohne Nagel without pin	LX235R	ohne Nagel without pin	16 x 9 cm 6 1/4" x 3 1/2"	Arm arm
LX206R	mit Nagel KX118S with pin KX118S			21 x 11 cm 8 1/4" x 4 3/8"	Oberschenkel und Knie femur and knee
LX207R	ohne Nagel without pin	LX237R	ohne Nagel without pin	21 x 11 cm 8 1/4" x 4 3/8"	Oberschenkel und Knie femur and knee
LX208R	mit Nagel KX121S with pin KX121S			21 x 15 cm 8 1/4" x 6"	Oberschenkel und Knie femur and knee
LX209R	ohne Nagel without pin			21 x 15 cm 8 1/4" x 6"	Oberschenkel und Knie femur and knee

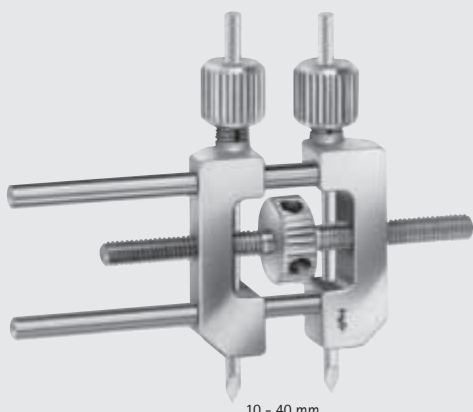

10 - 40 mm

LX310R

Kleiner Distraktor,
zum Distrahieren und Komprimieren von
kleinen Knochen, für Bohrdrähte Ø 3,0 mm

Small distractor,
as a repositioning device for distraction and com-
pression of small bones, for wires with 3.0 mm diam.



Drahtension – Wire extension

Nägel
Pins

Implantatwerkstoff: Nichtrostender Stahl nach DIN 17 443
bzw. ISO 5832/I (AISI 316 L)

Material used for implants: stainless steel acc. to DIN 17 443
resp. ISO 5832/I (AISI 316 L)

X1



Länge length	∅ diam. 4 mm	∅ diam. 5 mm
80 mm	KX108S	
100 mm	KX110S	
120 mm	KX112S	
140 mm	KX114S	
150 mm	KX115S	KX245S
160 mm	KX116S	
180 mm	KX118S	KX248S
200 mm	KX120S	KX250S
210 mm	KX121S	
250 mm	KX125S	KX255S
300 mm		KX260S

STEINMANN

KX108S-KX260S

mit 3-Kant-Schaft und Trokarspitze
Form C nach DIN 58 824

mit 3-Kant-Schaft und Trokarspitze
Form C nach DIN 58 824

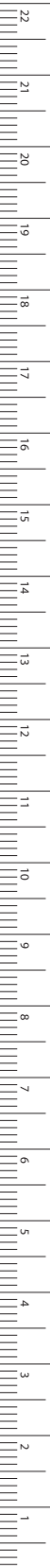

MILLIMETERS



1/1

KX262

Schutzkappe
für STEINMANN-Nägel, ∅ 4 mm
Protection cap
for STEINMANN pins, diam. 4 mm



1/1

KX261

Schutzkappe
für STEINMANN-Nägel, ∅ 5 mm
Protection cap
for STEINMANN pins, diam. 5 mm

Drahtextension – Wire extension

Handbohrfutter

Drilling Chucks



FR105R

Handbohrfutter, längsdurchbohrt,
Spannweite 0,8 - 2,0 mm Ø

Drilling chuck, cannulated,
for shanks from
0.8 mm - 2.0 mm diam.

150 mm, 6"



FR103R

Handbohrfutter, längsdurchbohrt,
Spannweite bis 4,5 mm Ø, mit
Spannschlüssel GA062R

Drilling chuck, cannulated, for shanks
up to 4.5 mm diam., with key GA062R

140 mm, 5 1/2"

Spannbacken aus
Implantatwerkstoff

Chuck jaws made of material
used for implants



LX202S

Handbohrfutter, längsdurchbohrt,
Spannweite bis 6,35 mm Ø,
von Hand zu spannen

Drilling chuck, cannulated,
for shanks up to 6.35 mm diam.,
to be tightened by hand

100 mm, 4"



LX210R

Handbohrfutter, längsdurchbohrt,
Spannweite bis 4,5 mm Ø und für
3-Kant-Schaft SW 4,7 (SCHANZsche
Schrauben, STEINMANN Nägel), mit
Spannschlüssel GA062R

Drilling chuck, cannulated, for
shanks up to 4.5 mm diam. and for
triangular shaft width across flats
4.7 mm (SCHANZ screws,
STEINMANN pins), with key GA062R



LX203R

Handbohrfutter, längsdurchbohrt,
Spannweite bis 6,35 mm Ø, mit
Spannschlüssel GA031R

Drilling chuck, cannulated, for
shanks up to 6.35 mm diam.,
with key GA031R

160 mm, 6 1/4"



Drahtextension – Wire extension

Cerclage-Instrumente Cerclage Instruments



KY002S-KY015S

Draht, weich, gewebeverträglich, in Ringen zu 10 m

Implantatwerkstoff: Nichtrostender Stahl nach DIN 17 443 bzw. ISO 5832/I grade B (AISI 316 LVM)

Wire, soft, tissue compatible, in coils of 10 m

Material used for implants: stainless steel acc. to DIN 17 443 resp. ISO 5832/I grade B (AISI 316 LVM)

Ø	diam.	0,2 mm	0,3 mm	0,4 mm	0,5 mm	0,6 mm	0,7 mm	0,8 mm	0,9 mm	1,0 mm	1,2 mm	1,5 mm
		KY002S	KY003S	KY004S	KY005S	KY006S	KY007S	KY008S	KY009S	KY010S	KY012S	KY015S
Gauge		35	30	27	25	23	22	21	20	19	18	17



1/1

ORMROD-SCHMITT

KY100S

Ligaturplättchen

Ligature disc

Implantatwerkstoff: Nichtrostender Stahl nach DIN 17 443 bzw. ISO 5832/I grade B (AISI 316 LVM)

Material used for implants: stainless steel acc. to DIN 17 443 resp. ISO 5832/I grade B (AISI 316 LVM)



1/2

LOUTE

KY220S

Drahtspanner, verbessertes Modell, mit an der Spitze eingebauter beweglicher Drahtspannbuchse für Draht bis 1,0 mm Ø
Wire tightener, improved pattern, with movable tip, for wires up to 1.0 mm diam.

220 mm, 8 3/4"

Spannbuchse aus **Implantatwerkstoff**, drehbar gelagerte Kopfscheibe.
Die drehbar gelagerte Kopfscheibe dreht sich während des Quirlvorgangs nicht mit.
Dadurch wird ein Abscheren des Cerclage-Drahts vermieden.
Movable tip made of **material used for implants**.
While twisting the movable head remains stable, therefore the wire will not slip off.



1/1

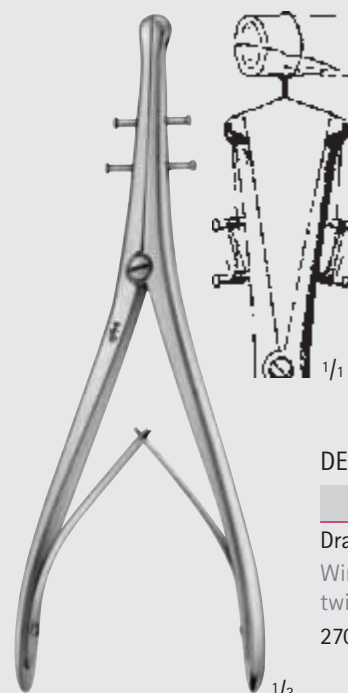

1/3

DEMEL

KY225R

Drahtspannzange
Wire tightening- and twisting forceps
270 mm, 10 3/4"

X7

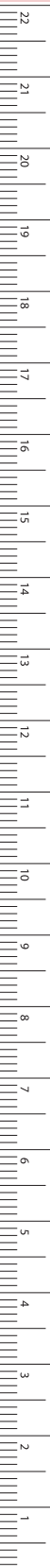

MILLIMETERS

Drahtextension – Wire extension

Cerclage-Instrumente

Cerclage Instruments

LX



DEMEL

KY201R-KY203R

Drahtumführungsnaedeln

Wire guides

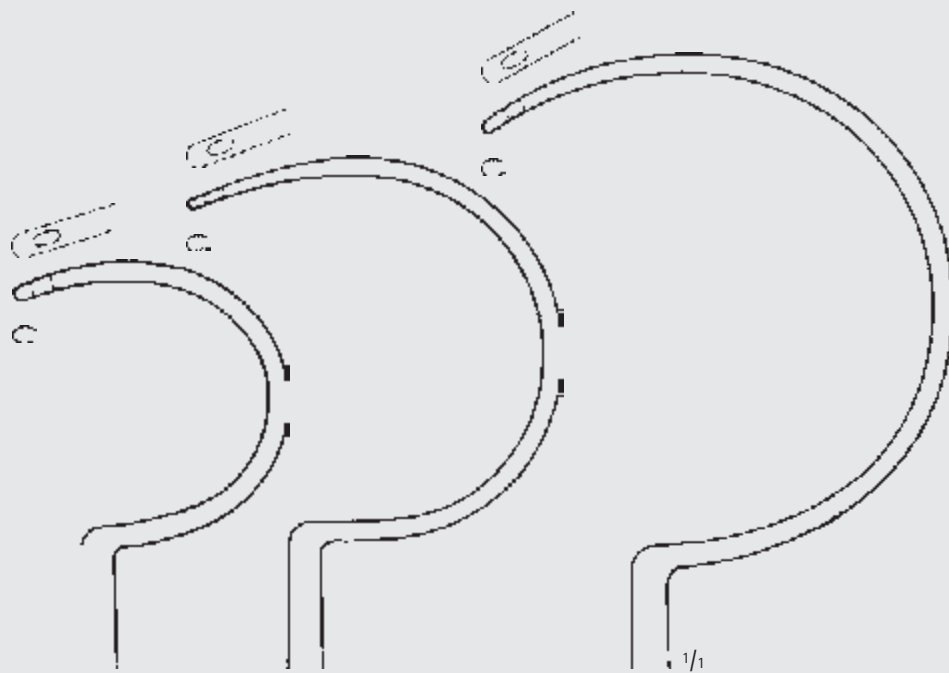

KY201R

275 mm

10 ³/₄"

KY202R

285 mm

11 ¹/₄"

KY203R

305 mm

12"

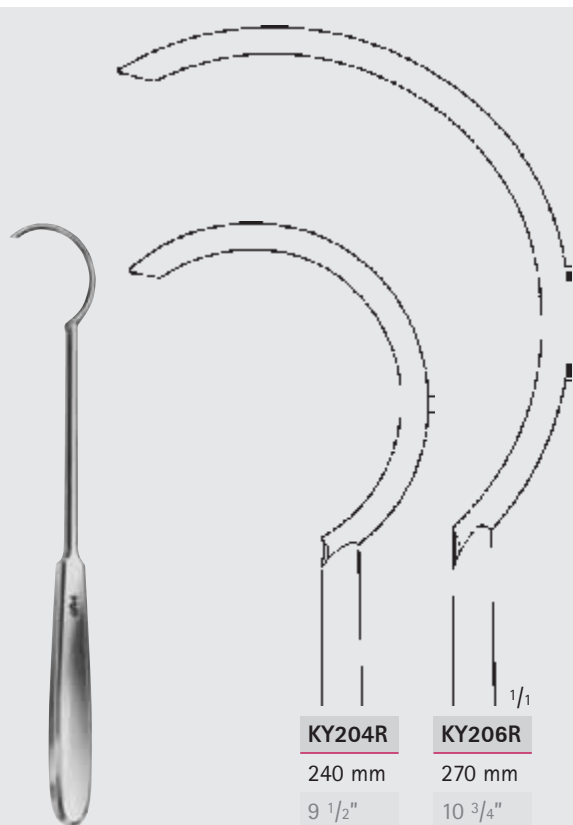

KY204R

240 mm

9 ¹/₂"

KY206R

270 mm

10 ³/₄"

KY204R-KY206R



KY205R

225 mm, 9"



mit Hartmetallbacken



with hard metal inserts

Drahtextension – Wire extension Drahtfasszangen, Drahtspannzangen Wire Holding Forceps, Wire Twisters

X1



LX176R

Drahtfasszange mit
seitlichen Backen gegen
Abrutschen des Drahtes
Holding forceps for cerclage
wire, with lateral jaws to
avoid wire slipping off
1/2 170 mm, 6 3/4"



BM110R

Drahtspannzange,
Ligaturzange
Wire twister,
Ligature forceps
150 mm, 6"



BM111R

Drahtspannzange,
Ligaturzange
Wire twister,
Ligature forceps
1/2 150 mm, 6"



BAUMGARTNER

BM112R

Drahtspannzange,
Ligaturzange
Wire twister,
Ligature forceps
1/2 200 mm, 8"

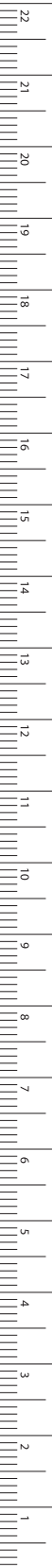

MILLIMETERS

Drahtextension – Wire extension
 Drahtspannzangen, Drahtschneidezangen
 Wire Twisters, Wire Cutting Scissors

mit Hartmetallbacken

 with hard metal inserts

LX

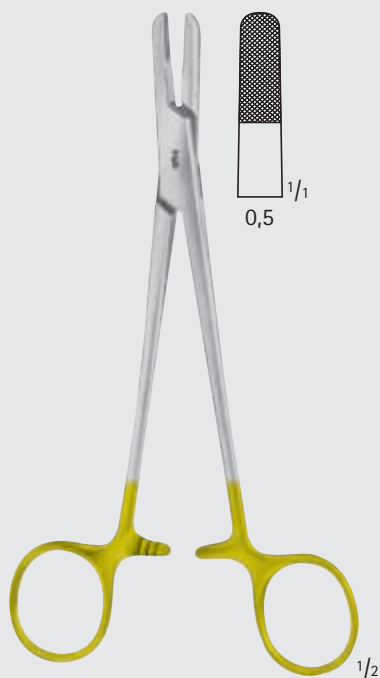

BM113R

für die Sternennaht
 for sternum suture
 175 mm, 7"



BERRY

MD456R

Drahtspannzange,
 Ligaturzange
 Wire twister, ligature forceps
 185 mm, 7 1/4"



LX149R

abgewinkelte schlanke Form zur Drahtentfernung
 (für weichen Draht bis Ø 0,9 mm) nach Sternennaht
 angled slender pattern for wire removal
 (for soft wire up to diam. 0.9 mm) after sternum suture
 170 mm, 6 3/4"

INCHES



Drahtextension – Wire extension

Drahtfasszangen, Drahtspannzangen, Flachzangen
Wire Holding Forceps, Wire Twisters, Flat-Nosed Pliers

X1

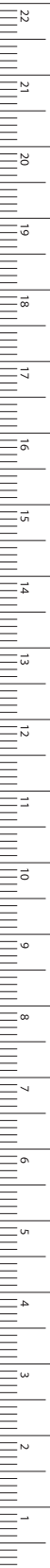

MILLIMETERS



MARBURG MODELL

DP031R

beidseitig kariert
with serrated jaws
140 mm, 5 1/2"



GOSLEE

DP035R

eine Seite kariert,
eine Seite glatt
one jaw smooth,
one jaw serrated
140 mm, 5 1/2"



LX170R

mit gerieften Backen
with serrated jaws

LX171R

mit Längs- und Querrillen
with longitudinal and
transversal grooves
170 mm, 6 3/4"



LX172R

190 mm, 7 1/2"

Drahtextension – Wire extension

Drahtfasszangen, Flachzangen

Wire Holding Forceps, Flat-Nosed Pliers

Die als Fräsbacken gearbeiteten Maulenden ermöglichen es, Drahtenden freizulegen. Maulprofile gewährleisten absolut sicheres Fassen der Drahtenden.

Exposure of grown-in wire ends is possible due to milling ends of the jaws. Profiles of the jaws guarantee absolutely safe gripping of the wire ends.



LX177R

130 mm

5 1/8"

LX178R

180 mm

7"

LX177R-LX178R

Extraktionszangen für Bohrdrähte
Extraction pliers for boring wires



LX189R

Parallel-Flachzange
Flat-nosed pliers, parallel
185 mm, 7 1/4"



MB576R

195 mm, 7 3/4"

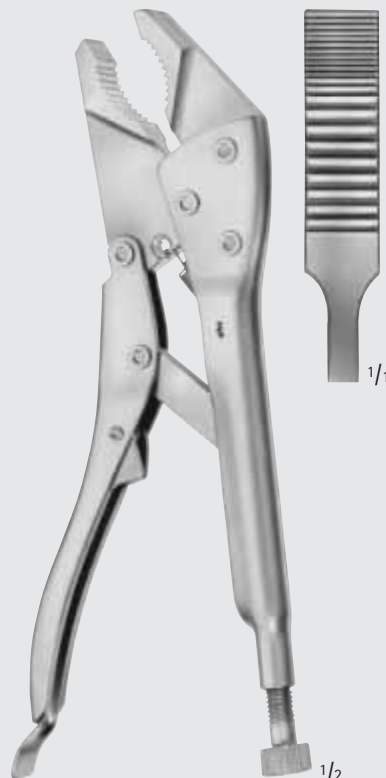

LX174R

Tonnenzange
Vise grip
200 mm, 8"



Drahtextension – Wire extension

Drahtfasszangen, Biegezangen

Wire Holding Forceps, Pliers for Bending and Cutting Wires

X1



LX181R

LX181R

180 mm

7"

Rundzange
Round pliers



LX185R

145 mm

5 3/4"

Extraktionszangen für Bohrdrähte
Extraction pliers for wires



LX182R

180 mm

7"



LX183R

180 mm

7"

LX181R-LX185R



LX190R

Biegezange für Spickdrähte bis 1,8 mm Ø
Bending pliers for wires up to 1.8 mm diam.

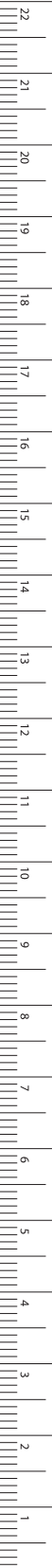

MILLIMETERS

Drahtextension – Wire extension
 Drahtschneidezangen und -Scheren
 Wire Cutters and Wire Cutting Scissors



ANGLE

DP540R

130 mm, 5 1/8"

für weichen Draht bis Ø 0,5 mm
 für harten Draht bis Ø 0,3 mm

for soft wire up to diam. 0.5 mm
 for hard wire up to diam. 0.3 mm



spezialvergütete
Schneiden
 specially hardened
 cutting edges

DP541R

130 mm, 5 1/8"

0,6 mm
 0,4 mm

0.6 mm
 0.4 mm



1/1
 1 Schneide gezahnt
 1 blade serrated

DP551R

120 mm, 4 3/4"

für weichen Draht bis Ø 1,2 mm
 für harten Draht bis Ø 0,6 mm

for soft wire up to diam. 1.2 mm
 for hard wire up to diam. 0.6 mm

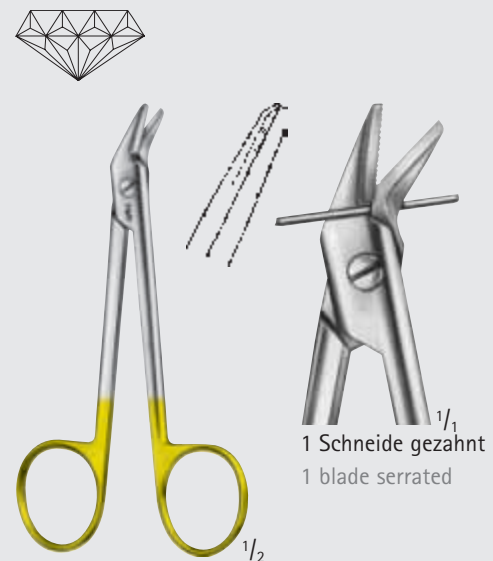

1/1
 1 Schneide gezahnt
 1 blade serrated

DP552R

120 mm, 4 3/4"

1,2 mm
 0,8 mm

1.2 mm
 0.8 mm



Drahtextension – Wire extension

Drahtschneidezangen und -Scheren

Wire Cutters and Wire Cutting Scissors



HARVEY

BC815R

125 mm, 5"

für weichen Draht bis Ø
für harten Draht bis Ø

0,4 mm
0,3 mm

for soft wire up to diam.
for hard wire up to diam.

0.4 mm
0.3 mm



DP501R

150 mm, 6"

1,5 mm
1,0 mm

1.5 mm
1.0 mm



DP505R

160 mm, 6 1/4"

für weichen Draht bis Ø
für harten Draht bis Ø

1,5 mm
1,2 mm

for soft wire up to diam.
for hard wire up to diam.

1.5 mm
1.2 mm



DP530R

140 mm, 5 1/2"

1,5 mm
1,0 mm

1.5 mm
1.0 mm

X1



MILLIMETERS

Drahtextension – Wire extension
 Drahtschneidezangen und Seitenschneider
 Wire Cutters, Lateral Cutting Action

LX

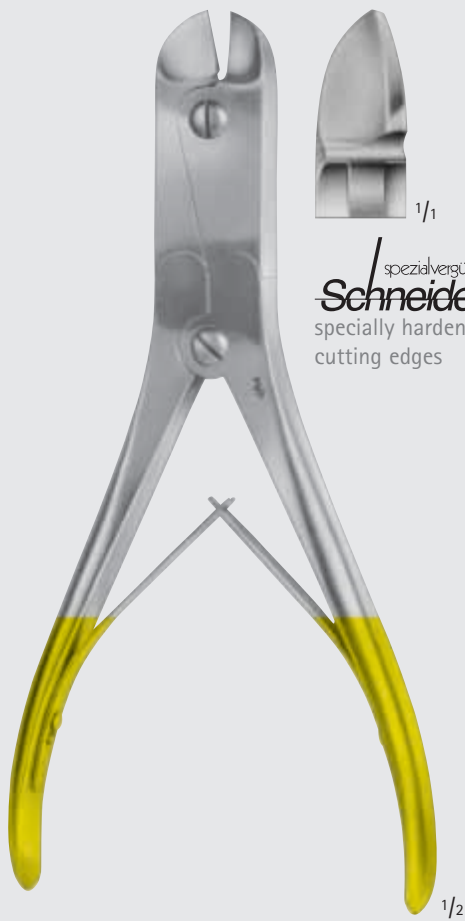

1/1
 spezialvergütete
Schneiden
 specially hardened
 cutting edges

LX156R

235 mm, 9 1/4"

für weichen Draht bis Ø 3,0 mm
 für harten Draht bis Ø 2,2 mm

for soft wire up to diam. 3.0 mm
 for hard wire up to diam. 2.2 mm



1/1
 spezialvergütete
Schneiden
 specially hardened
 cutting edges

HARVEY

LX157R

235 mm, 9 1/4"

3,0 mm
 2,2 mm

3.0 mm
 2.2 mm



Drahtextension – Wire extension

Drahtschneidezangen und Seitenschneider

Wire Cutters, Lateral Cutting Action

X1



LX149R

abgewinkelte schlanke Form zur Drahtentfernung nach Sternumnaht
angled slender pattern for wire removal after sternum suture
170 mm, 6 ³/₄"

für weichen Draht bis Ø 0,9 mm
für harten Draht bis Ø -

for soft wire up to diam. 0.9 mm
for hard wire up to diam. -



LX162R

240 mm, 9 ¹/₂"

2,5 mm
2,0 mm

2.5 mm
2.0 mm

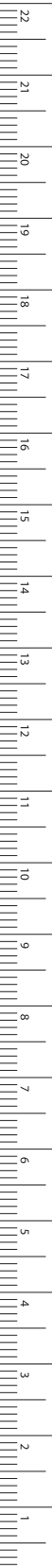

MILLIMETERS

Drahtextension – Wire extension
 Drahtschneidezangen und Seitenschneider
 Wire Cutters, Lateral Cutting Action

LX



LX158R

Kopf- und Seitenschneider
 Wire Cutters, front- and lateral cutting action
 180 mm, 7"



REILL

LX159R

Schneiden gebogen, zum Abzwicken
 direkt am Knochen
 for cutting off wires close to the bone
 175 mm, 7"

für weichen Draht bis Ø	2,0 mm
für harten Draht bis Ø	1,5 mm

for soft wire up to diam.	2.0 mm
for hard wire up to diam.	1.5 mm

2,0 mm
1,5 mm

2.0 mm
1.5 mm



Drahtextension – Wire extension

Drahtschneidezangen, Kopfschneider

Wire Cutters, Front Cutting Action

X1

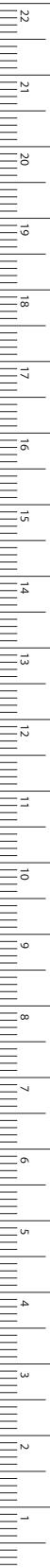

MILLIMETERS



spezialvergütete
Schneiden
specially hardened
cutting edges

DP520R
145 mm, 5 3/4"

für weichen Draht bis Ø 1,5 mm
für harten Draht bis Ø 1,0 mm

for soft wire up to diam. 1.5 mm
for hard wire up to diam. 1.0 mm



spezialvergütete
Schneiden
specially hardened
cutting edges

LX150R
145 mm, 5 3/4"

2,0 mm
1,5 mm

2.0 mm
1.5 mm



spezialvergütete
Schneiden
specially hardened
cutting edges

LX152R
220 mm, 8 3/4"

für weichen Draht bis Ø 3,0 mm
für harten Draht bis Ø 2,0 mm

for soft wire up to diam. 3.0 mm
for hard wire up to diam. 2.0 mm



spezialvergütete
Schneiden
specially hardened
cutting edges

LX163R
165 mm, 6 1/2"

3,5 mm
2,5 mm

3.5 mm
2.5 mm

Drahtextension – Wire extension

Drahtschneidezangen

Wire Cutting Pliers

LX



LX165R

Bolzenschneider zum Abzwicken von KIRSCHNER-Drähten, Tibia-Kopf-Schrauben und Nägeln bis zu 3 mm Ø

Cutter for cutting off KIRSCHNER wires, tibia head screws, bolts, pins, up to 3 mm diam.

320 mm, 12 3/4"



LX164R

Bolzenschneider zum Abzwicken von KIRSCHNER-Drähten, Tibia-Kopf-Schrauben und Nägeln bis 6 mm Ø

Cutter for cutting off KIRSCHNER wires, tibia head screws, bolts, pins, up to 6 mm diam.

470 mm, 18 1/2"



Drahtension – Wire extension

Fingernagel-Instrumente Finger Nail Instruments

X7

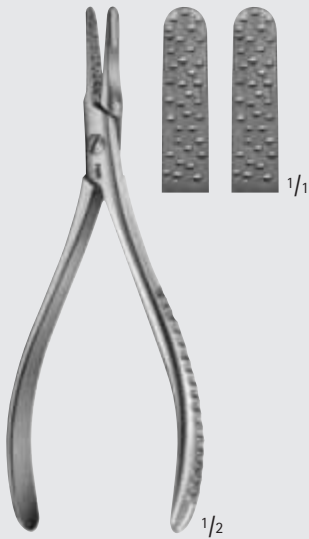

FO903R

Nagelausreibzange
Nail extracting forceps
135 mm, 5 1/2"

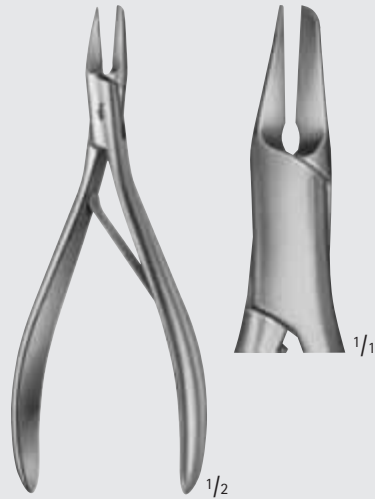

HF266R

Nagelspaltzange
Nail splitting forceps
130 mm, 5 1/8"



SYSTRUNK

BC521R

Schere für eingewachsene Nägel
Scissors for splitting finger nails
130 mm, 5 1/8"



FO900R

Fingerringssäge
Finger ring saw
150 mm, 6"



FO901R

Ersatz-Sägeblatt
Spare blade



MILLIMETERS



INCHES

LX



Gips-Instrumente
Plaster Instruments

Gips-Instrumente – Plaster Instruments

Gips-Instrumente
Plaster Instruments

LX



1/2

ESMARCH

LX505R

Gipsmesser
Plaster knives
180 mm, 7"



1/2

ENGEL

LX522C

Gipssäge
Plaster saw
150 mm, 6"



1/2

LISTER

BC885R-BC977R

BC885R	schwarz	black	BC973R	gelb	yellow
BC970R	rot	red	BC975R	orange	orange
BC971R	blau	blue	BC977R	pink	pink

Verband- und Erste-Hilfe-Scheren
Bandage- and First Aid Scissors
145 mm, 5 3/4"



2/3

BC881R-BC987R

BC881R	schwarz	black	BC983R	gelb	yellow
BC980R	rot	red	BC985R	orange	orange
BC981R	blau	blue	BC987R	pink	pink

Verband- und Erste-Hilfe-Scheren
Bandage- and First Aid Scissors
180 mm, 7"



Gips-Instrumente – Plaster Instruments

Gipsscheren
Plaster Scissors

X1



LX548R

für kleine Gipsverbände
for small plaster dressings
160 mm, 6 1/4"



ESMARCH

LX550R 200 mm 8"

LX552R 230 mm 9"



BERGMANN

LX553R

230 mm, 9"



MILLIMETERS

Gips-Instrumente – Plaster Instruments

Gipsscheren

Plaster Scissors

LX



BRUNS

LX556R

235 mm, 9 1/4"



LX558R

auch als Kleiderschere verwendbar
also to be used as bandage scissors
235 mm, 9 1/4"



SEUTIN

LX565R

auch als Kleiderschere verwendbar
also to be used as bandage scissors
230 mm, 9"



Gips-Instrumente – Plaster Instruments

Gipsscheren Plaster Shears

Besondere Vorteile:

- Die Konstruktion des offenen Kastens verhindert das lästige Verstopfen durch Gipsreste, außerdem ist eine leichte Reinigung der Backen möglich.
- Die tiefe Zahnung an den Backen verhindert das Abgleiten der Gipsschere vom Gips.
- Die Messer, mit Hohlschliff, weisen eine bessere Schnitffähigkeit auf, daher geringerer Kraftaufwand.
- Messerführung durch Kugellager.

Special features:

- The construction of the open jaws avoids tiresome clogging by plaster remnants and allows furthermore an easy cleaning.
- The shears do not glide off the plaster owing to the deep teething on the jaws.
- The knives with hollow grinding have a better cutting ability and therefore less force is required.
- The knives are guided by ball bearings.

Kastenteil offen

open jaws

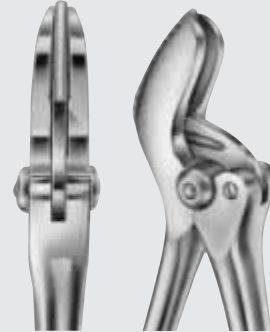

STILLE-AESFULAP

LX574R

260 mm, 10 1/4"



STILLE-AESFULAP

LX575R

360 mm, 14 3/8"

X1

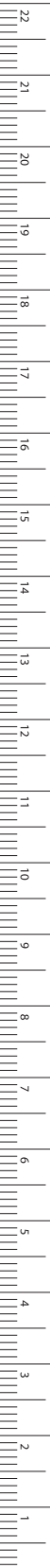

MILLIMETERS

Gips-Instrumente – Plaster Instruments

Gipsscheren

Plaster Shears

LX



STILLE

LX582R

230 mm, 9"



STILLE

LX587R

Messer mit verstärktem Rücken
Blade with reinforced back
370 mm, 14 2/3"



Gips-Instrumente – Plaster Instruments

Gipsspreizer, Gipsabreißzangen
Plaster Spreader, Plaster Breakers

X1



1/3

HENNIG

LX600R

270 mm, 10 3/4"



1/3

MOD.USA

LX605R

230 mm, 9"



1/3



1/1

mit abnehmbaren Backen
with removable jaws

LX610R

290 mm, 11 1/2"



1/2

WOLFF

LX618R 180 mm 7"

LX624R 240 mm 9 1/2"

Gipsabreißzangen (Rabenschnabel)
Plaster breakers

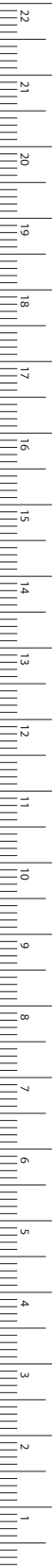

MILLIMETERS



INCHES

GF



Sauginstrumente
Suction Instruments

Sauginstrumente – Suction Instruments

Vakuümküretten

Vacuum Curettes



Kanülen zur Vakuümkürettage mit Graduierung und Saugunterbrecher

Curettes with graduation and suction interrupter, for vacuum curettage

Ø
diam.

4 mm (zur Saugbiopsie geeignet)
(suitable for suction biopsy)

GF704R

GF706R

GF708R

GF710R

GF712R

GF714R

6 mm

8 mm

10 mm

12 mm

14 mm



GF719R

Schlauchansatz, gerade
Innen-Ø: 11 mm

Hose connection, straight
inside diam.: 11 mm



GF720R

Schlauchansatz, gebogen
Innen-Ø: 11 mm

Hose connection, curved
inside diam.: 11 mm

Die Verbindung zwischen Saugküretten und Schlauchansatz GF720R gewährleistet schnelles Wechseln und freies Drehen der Saugküretten auf dem Schlauchansatz.

The connection between suction curette and hose connection GF720R guarantees quick changing and free turning of the suction curettes on the hose connection.

GF721

Saugschlauch, transparent, 1,8 m lang, Innen-Ø 11 mm, Außen-Ø 16,5 mm, sterilisierbar im Autoklav bei 143 °C (3 bar)

Transparent suction hose, 1.8 m long, inside diam. 11 mm, outside diam. 16.5 mm, can be sterilized in an autoclave at 143 °C (3 bar)



GF722

Gewebe-Auffangsieb aus Kunststoff, zum Einmalgebrauch für die histopathologische Untersuchung.

Strainer for tissue, plastic, for single use only, to be used for histopathological examination.



Sauginstrumente – Suction Instruments

Sauginstrumente
Suction Instruments

GF

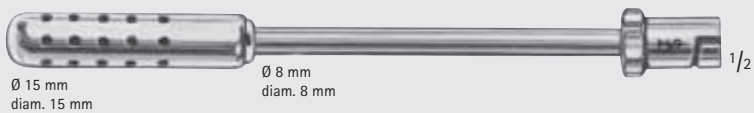

Ø 15 mm
diam. 15 mm

Ø 8 mm
diam. 8 mm

1/2

GF805C

zum Ableiten großer Flüssigkeitsmengen

for clearing large quantities of fluid

190 mm, 7 1/2"



1/2

GF806C

Trocar, zum Punktieren

Trocar, for puncturing

170 mm, 6 3/4"



1/2

GF809C

doppelt gebogen, für Allgemein-Chirurgie

double curved, for general surgery

230 mm, 9"

mit Renk-Verschluss
passend auf den Sauggriff
GF801C

with bayonet fitting to be
used with suction handle
GF801C



MILLIMETERS

Sauginstrumente – Suction Instruments

Sauginstrumente

Suction Instruments

GF



Olive Ø 8 mm
olive diam. 8 mm

GF801C

Sauggriff mit Vakuum-Regulierung und Unterbrecher,
Messing hochglanzverchromt

Suction handle, with vacuum regulator and finger
cut-off, brass, mirror-finish chromium-plated

150 mm, 6"

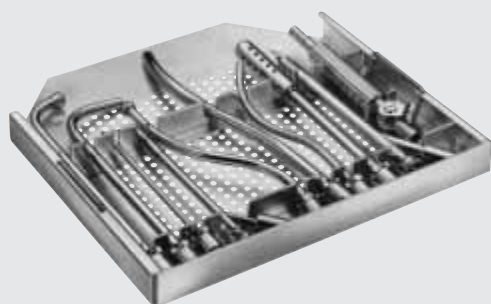

GF841

Alu-Lagerungsrack allein, ohne Instrumente,
passend in Basis Container, bestehend aus
Bodenteil JK339 und Deckel JK399

Aluminium rack only, without instruments,
fitting into Basis Container, consisting of
container body JK339 and lid JK399

265 x 250 x 30 mm

INCHES



Sauginstrumente – Suction Instruments

Sauginstrumente
Suction Instruments

GF



Ø 9 mm
diam. 9 mm

GF816C

Universal-Kanüle, doppelt gebogen
Universal cannula, double curved
230 mm, 9"

Olive Ø 9 mm
olive diam. 9 mm



▲
Ø 7 mm
Charr. 21

POOL

GF860R

Saugkanüle mit abschraubbarem Außenrohr
Suction cannula, with outer tube to be screwed off
225 mm, 9"

1/2
Olive Ø 6,5 - 9,5 mm
olive diam. 6.5 - 9.5 mm



▲
Ø 10 mm
Charr. 30

POOL

GF862R

Saugkanüle mit abschraubbarem Außenrohr
Suction cannula with outer tube to be screwed off
225 mm, 9"

1/2
Olive Ø 8 - 10,5 mm
olive diam. 8 - 10.5 mm



Ø 10 mm
diam. 10 mm

YANKAUER

GF944R

mit zentraler Bohrung, Ø 2,0 mm
with central bore, Ø 2.0 mm diam.
285 mm, 11 1/4"

1/2
Olive Ø 7 - 9 mm
olive diam. 7 - 9 mm



MILLIMETERS

Sauginstrumente – Suction Instruments

Sauginstrumente

Suction Instruments

GF

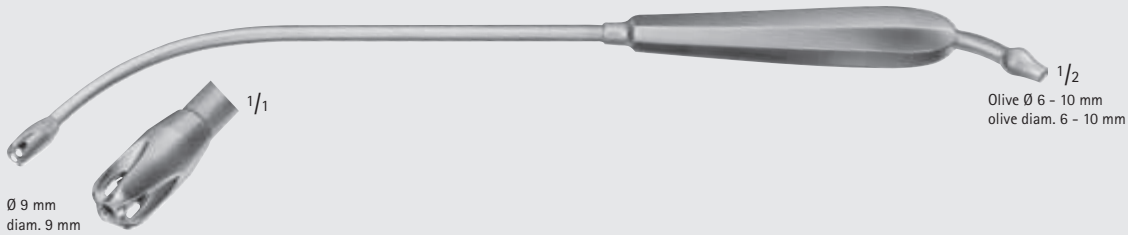

DE BAKEY

GF946R

mit zentraler Bohrung, Ø 3,0 mm und seitlichen Schlitzen
with central bore, 3.0 mm diam. with lateral slots

275 mm, 10 3/4"

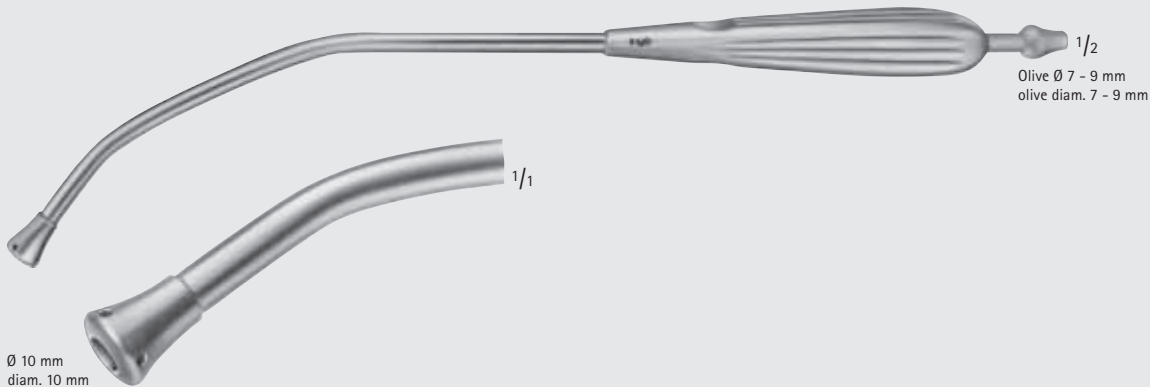

YANKAUER

OM671R

mit besonders großer zentraler Bohrung, Ø 4,8 mm
with especially large central bore, 4.8 mm diam.

285 mm, 11 1/4"

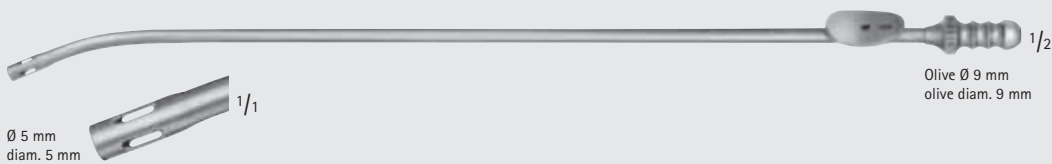

DE BAKEY

GF948R

mit Saugunterbrecher und Mandrin
with finger cut-off and stylet

270 mm, 10 3/4"

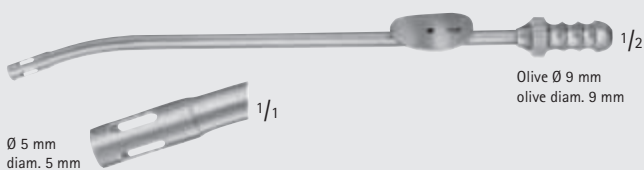

DE BAKEY

GF947R

mit Saugunterbrecher und Mandrin
with finger cut-off and stylet

160 mm, 6 1/4"

INCHES

Sauginstrumente – Suction Instruments

Sauginstrumente

Suction Instruments

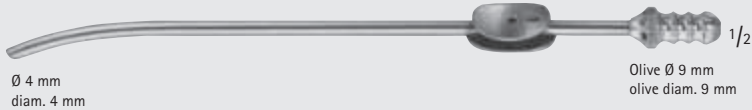
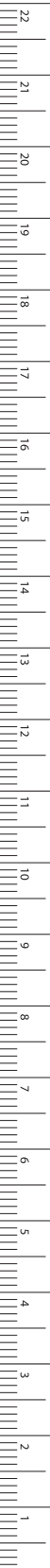

Ø 4 mm
diam. 4 mm

Olive Ø 9 mm
olive diam. 9 mm

ADSON

GF917R

mit Saugunterbrecher
with finger cut-off
190 mm, 7 1/2"

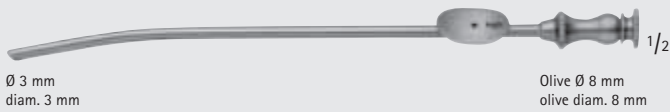

Ø 3 mm
diam. 3 mm

Olive Ø 8 mm
olive diam. 8 mm

ADSON

GF918R

mit Saugunterbrecher und Mandarin
with finger cut-off and stylet
165 mm, 6 1/2"

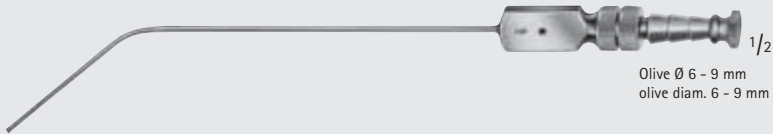

Olive Ø 6 - 9 mm
olive diam. 6 - 9 mm

PLESTER

mit Saugunterbrecher und Mandarin,
Griffplatte parallel zur Biegung, LUER-Bohrung
with finger cut-off and stylet, thumb piece
parallel to curve, with LUER hub
195 mm, 7 3/4"

	Ø diam.
GF939R	1,5 mm
GF940R	2,0 mm
GF941R	2,5 mm
GF942R	3,0 mm
GF355R	5,0 mm

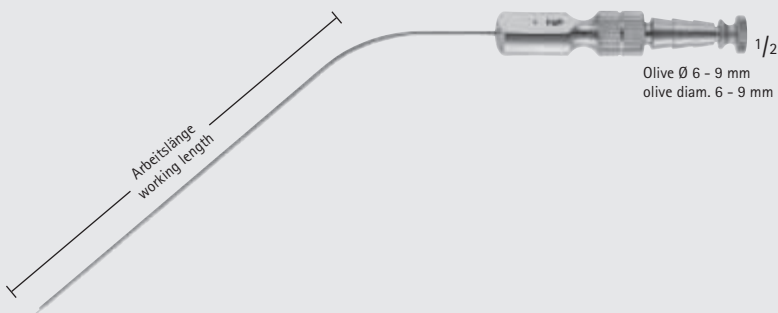

Olive Ø 6 - 9 mm
olive diam. 6 - 9 mm

FERGUSSON

mit Saugunterbrecher und Mandrin,
Griffplatte 90° zur Biegung, LUER-Bohrung
with finger cut-off and stylet, thumb piece
90° to curve, with LUER hub
180 mm, 7"

	diam. Ø
GF350R	1,5 mm
GF351R	2,0 mm
GF352R	2,5 mm
GF353R	3,0 mm
GF354R	4,0 mm

Sauginstrumente – Suction Instruments

Sauginstrumente
Suction Instruments



Olive Ø 6 - 9 mm
olive diam. 6 - 9 mm

FERGUSSON

GF933R Ø diam. 4,0 mm

isoliert, mit Saugunterbrecher und Mandrin,
Griffplatte 90° zur Biegung, LUER-Bohrung

isolated, with finger cut-off and stylet,
thumb piece 90° to curve, with LUER hub

180 mm, 7"



Olive Ø 6 - 9 mm
olive diam. 6 - 9 mm

FRAZIER

Ø	diam.

GF923R 3,0 mm

GF925R 5,0 mm

mit Saugunterbrecher und Mandrin,
Griffplatte 90° zur Biegung, LUER-Bohrung

with finger cut-off and stylet, thumb
piece 90° to curve, with LUER hub

180 mm, 7"



FRAZIER

Ø	diam.

MD124R 2,3 mm

MD125R 2,7 mm

MD127R 3,4 mm

MD129R 4,0 mm

mit Saugunterbrecher und Mandrin,
Griffplatte 90° zur Biegung, LUER-Bohrung
with finger cut-off and stylet, thumb piece 90°
to curve, with LUER hub

110 mm, 4 1/4"



Sauginstrumente – Suction Instruments

Sauginstrumente

Suction Instruments

GF

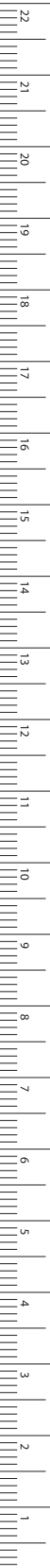

LEMPERT

Ø
diam.

GF937R 2,0 mm

GF938R 3,0 mm

mit Saugunterbrecher und Mandrin
with finger cut-off and stylet
200 mm, 8"

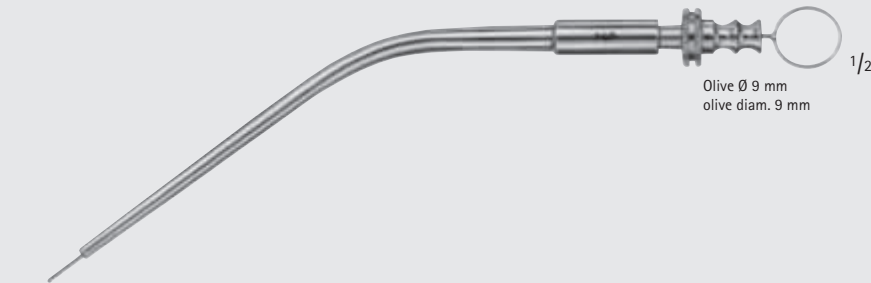

FORMBY

Ø
diam.

GF932R 3,3 mm

210 mm, 8 1/4"

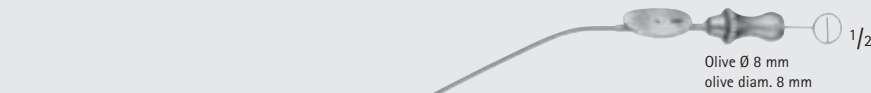

BARRON

Ø
diam.

GF935R 1,3 mm

GF936R 2,0 mm

mit Saugunterbrecher und Mandrin
with finger cut-off and stylet
160 mm, 6 1/4"

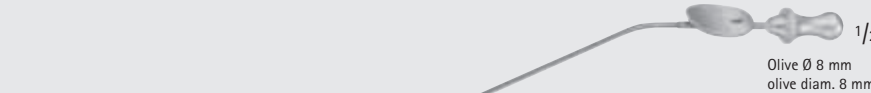

SCHUHKNECHT

Ø Ø
diam. diam.

GF756R 20 swg 1,0 mm

GF757R 24 swg 0,5 mm

Saugkanülen
Suction cannulae
130 mm, 5 1/8"

MILLIMETERS

Sauginstrumente – Suction Instruments

Sauginstrumente
Suction Instruments

GF

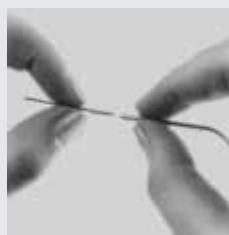

WULLSTEIN

OG960R

Mikro-Absaugrohr komplett, bestehend aus:

Micro suction tube, complete, consisting of:

OG961R	Absaugrohr mit LUER-Bohrung	Suction tube with LUER hub
OG962R	Mikro-Saugkanüle, Ø 0,4 mm	Micro suction cannula, 0.4 mm diam.
OG963R	Mikro-Saugkanüle, Ø 0,6 mm	Micro suction cannula, 0.6 mm diam.
OG964R	Mikro-Saugkanüle, Ø 0,8 mm	Micro suction cannula, 0.8 mm diam.

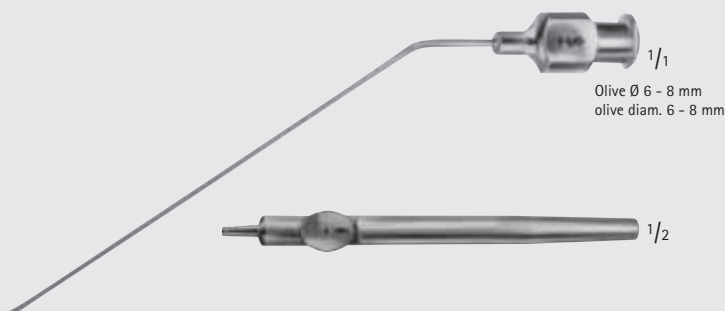

OG970R

Saugset komplett, bestehend aus:

Suction set, complete, consisting of:

OG971R	Saughandgriff mit LUER-Konus, mit Unterbrecher	Suction handle, with finger cut-off, with LUER cone
OG972R	2 Saugkanülen, Ø 0,5 mm, mit LUER-Konus	2 suction cannulae, 0.5 mm diam., with LUER cone
OG973R	2 Saugkanülen, Ø 0,7 mm, mit LUER-Konus	2 suction cannulae, 0.7 mm diam., with LUER cone
OG974R	2 Saugkanülen, Ø 1,0 mm, mit LUER-Konus	2 suction cannulae, 1.0 mm diam., with LUER cone
OG969R	2 Saugkanülen, Ø 1,3 mm, mit LUER-Konus	2 suction cannulae, 1.3 mm diam., with LUER cone

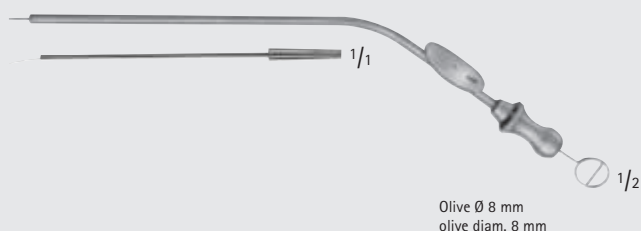

BELLUCCI

OG950R

Saugset komplett, bestehend aus:

Suction set, complete, consisting of:

OG951R	Saugrohr allein, mit Saugunterbrecher und Mandrin	Suction tube with finger cut-off and stylet	155 mm, 6"
GF772R	Saugkanüle Ø 20 swg., Ø 1,0 mm	Detachable end, 20 swg. diam., 1.0 mm diam.	
GF773R	Saugkanüle Ø 22 swg., Ø 0,7 mm	Detachable end, 22 swg. diam., 0.7 mm diam.	
GF774R	Saugkanüle Ø 24 swg., Ø 0,5 mm	Detachable end, 24 swg. diam., 0.5 mm diam.	



ZOELLNER

GF770R

Saugkanüle allein, mit Mandrin, passend zu den Saugaufsätzen GF771R und GF775R

Suction cannula only, with stylet, fitting to the detachable ends GF771R and GF775R

180 mm, 7"

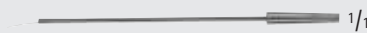

ZOELLNER

	Ø diam.	Ø diam.
GF771R	18 swg	1,2 mm
GF772R	20 swg	1,0 mm
GF773R	22 swg	0,7 mm
GF774R	24 swg	0,5 mm
GF775R	26 swg	0,4 mm

auswechselbare Spitzen zu GF770R und OG951R
detachable ends, fitting to GF770R and OG951R

Bestelleinheit:

PAK = Packung à 10 Stück

Sales unit:

PAK = Package of 10 pieces



VERHOEVEN

	Ø diam.	Ø diam.
GF763R	16 swg	1,5 mm
GF764R	18 swg	1,2 mm
GF765R	20 swg	1,0 mm
GF766R	22 swg	0,7 mm
GF767R	24 swg	0,5 mm

Saugkanülen mit LUER-Konus

Suction cannulae with LUER cone

100 mm, 4"



HOUSE

GF768R

Saugadapter mit Saugunterbrecher,
LUER-Konus / LUER-Bohrung

Suction adapter with finger cut-off,
LUER cone, LUER hub

55 mm, 2 1/8"

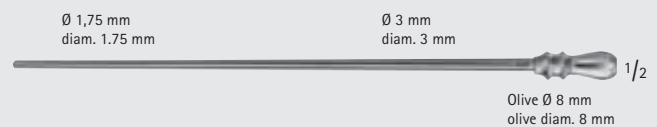

WULLSTEIN

OF237

Saugrohr, konisch, aus Silber, Olive mit LUER-Bohrung

Suction tube, conical, silver, olive with LUER hub

160 mm, 6 1/4"



MILLIMETERS

Sauginstrumente – Suction Instruments

Sauginstrumente

Suction Instruments

GF

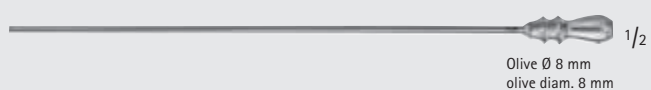

WULLSTEIN

	Ø diam.
OF239	1,5 mm
OF238	2,0 mm

Saugrohr, zylindrisch, aus Silber, mit Mandrin, Olive mit LUER-Bohrung

Suction tube, cylindrical, silver, with stylet, olive with LUER hub

160 mm, 6 1/4"

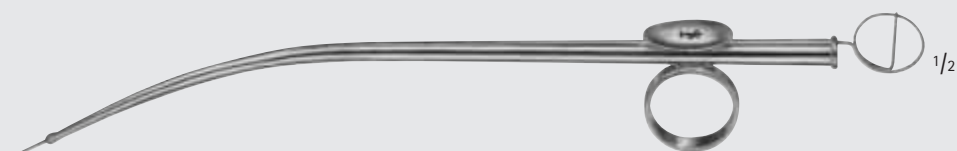

MAGILL

	Ø diam.
GF906R	3,0 mm
GF907R	3,5 mm
GF908R	4,0 mm

245 mm, 9 3/4"

GF909R

Reinigungsdraht zu MAGILL-Saugkanülen

Stilette for MAGILL suction tubes



Olive Ø 6 - 9 mm
olive diam. 6 - 9 mm

	Ø diam.	Spitzenbreite Tip width
GF919R	5,0 mm	6,5 mm

Nasensaugrohr, LUER-Bohrung

Nasal suction tube, with LUER hub

180 mm, 7"

INCHES



Sauginstrumente – Suction Instruments

Sauginstrumente
Suction Instruments

GF

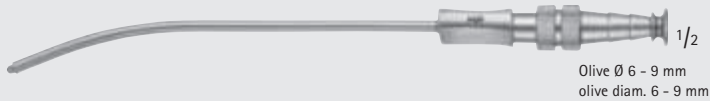

Olive \varnothing 6 - 9 mm
olive diam. 6 - 9 mm

GILLIES

\varnothing
diam.

OL187R 3,0 mm

mit Saugunterbrecher und Mandrin
with finger cut-off and stylet
170 mm, 6 $\frac{3}{4}$ "

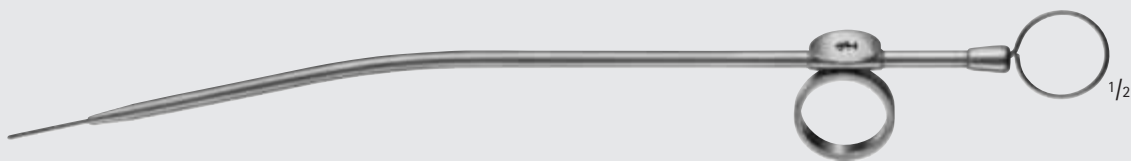

ROWBOTHAM

OM672R

mit Mandrin
with stylet
295 mm, 11 $\frac{3}{4}$ "

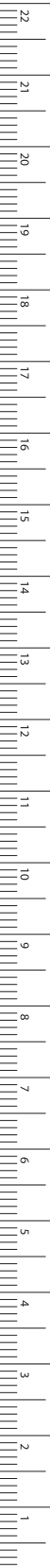

MILLIMETERS

Sauginstrumente – Suction Instruments

Sauginstrumente

Suction Instruments

GF

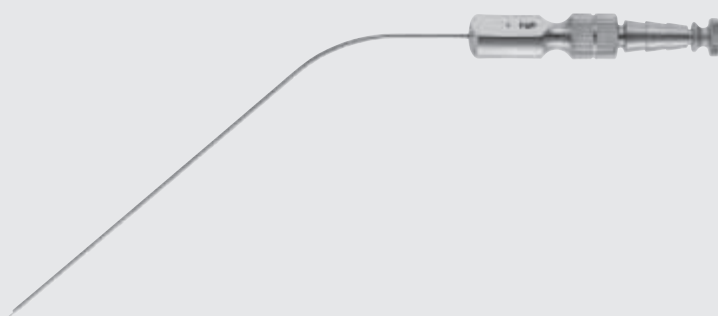

FERGUSSON

Ø diam.	Länge Length	Länge Length	Länge Length
	130 mm	160 mm	200 mm
1,5 mm	GF360R	GF370R	GF380R
2,0 mm	GF361R	GF371R	GF381R
2,5 mm	GF362R	GF372R	GF382R
3,0 mm	GF363R	GF373R	GF383R
4,0 mm	GF364R	GF374R	GF384R
5,0 mm	GF365R	GF375R	GF385R

Ø 3,5 mm
diam. 3.5 mm

Ø 2,0 mm
diam. 2.0 mm

Olive
Ø 6 - 9 mm
olive
diam. 6 - 9 mm

1/3

OP030R	500 mm	20"
OP031R	350 mm	14"

mit Gummispitze, mit LUER-Bohrung
with rubber tip, with LUER hub

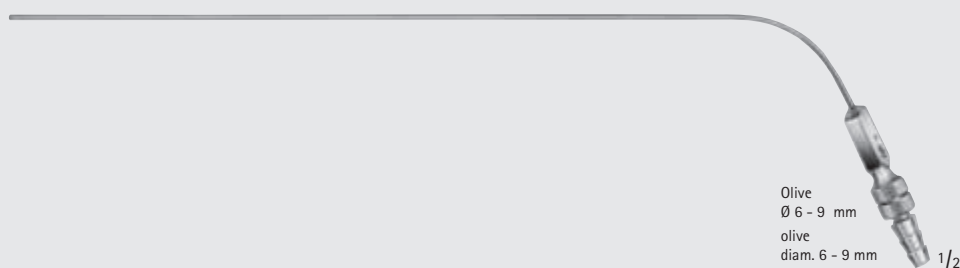

Olive
Ø 6 - 9 mm
olive
diam. 6 - 9 mm

1/2

	Ø diam.
OP360R	2,0 mm
OP361R	2,5 mm
OP362R	3,0 mm

mit Saugunterbrecher, Griffplatte 90° zur Biegung, mit LUER-Bohrung
with finger cut-off, thumb piece 90° to curve, with LUER hub
250 mm, 10"



Sauginstrumente – Suction Instruments

Sauginstrumente
Suction Instruments

GF

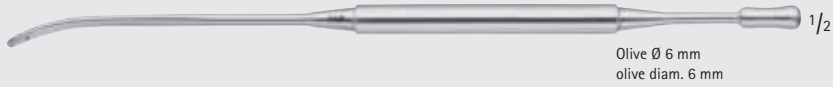

Olive Ø 6 mm
olive diam. 6 mm

NEGUS

OL177R

Saugdissektor

Suction dissector

210 mm, 8 1/4"

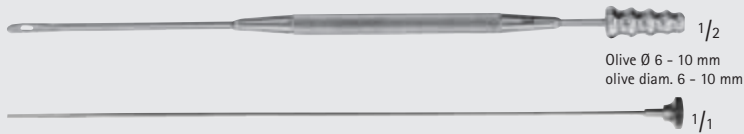

Olive Ø 6 - 10 mm
olive diam. 6 - 10 mm

GORNEY

OL168R

Saugdissektor

Suction dissector

180 mm, 7"



Olive Ø 6 - 9 mm
olive diam. 6 - 9 mm

breit
wide

OL195R 4 mm

OL196R 5 mm

Saugraspatorium, scharf, bajonettförmig gebogen, mit Mandarin

Suction raspatories, sharp, bayonet-shaped, with stylet

200 mm, 8"



Olive Ø 6 - 9 mm
olive diam. 6 - 9 mm

LANDOLT

breit
wide

GF980R 3,2 mm

Präpariersauger für Hypophysektomie und HNO, winklige Spitze, scharf

Dissecting suction tube for hypophysectomie and ENT, sharp angled point

200 mm, 8"



Olive Ø 9 mm
olive diam. 9 mm

LOPEZ-REINKE

OM670R

Tonsillendissektor mit Absaugvorrichtung

Tonsil dissector with suction device

235 mm, 9 1/4"



MILLIMETERS

Sauginstrumente – Suction Instruments

Kombinierte Saug- und Spülkanülen

Combined Suction- and Irrigation Cannulae

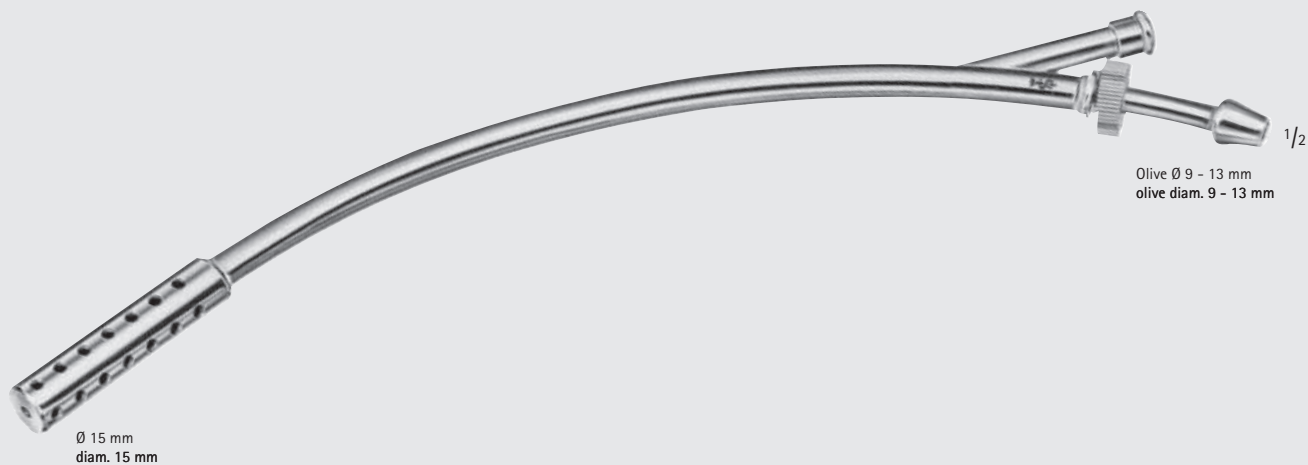

FINSTERER

GF867C

320 mm, 12 3/4"

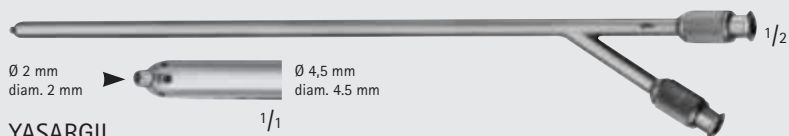

YASARGIL

GF905R

LUER-LOCK-Konus

LUER-LOCK cone

200 mm, 8"

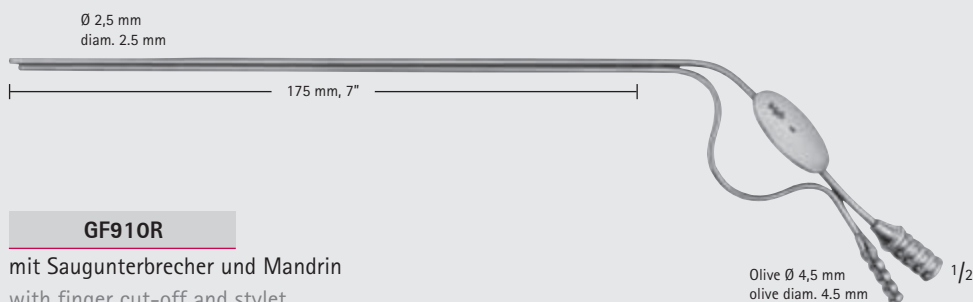

GF910R

mit Saugunterbrecher und Mandrin

with finger cut-off and stylet

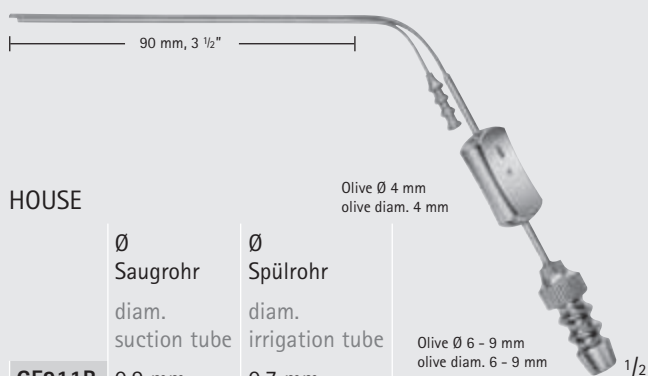

HOUSE

	Ø Saugrohr diam. suction tube	Ø Spülrohr diam. irrigation tube
GF911R	0,9 mm	0,7 mm
GF912R	1,2 mm	0,9 mm
GF913R	1,5 mm	1,2 mm

mit Saugunterbrecher und Mandrin, LUER-Bohrung

with finger cut-off and stylet, with LUER hub

INCHES



Sauginstrumente – Suction Instruments

Koagulations-Saugkanüle

Coagulation Suction Cannula

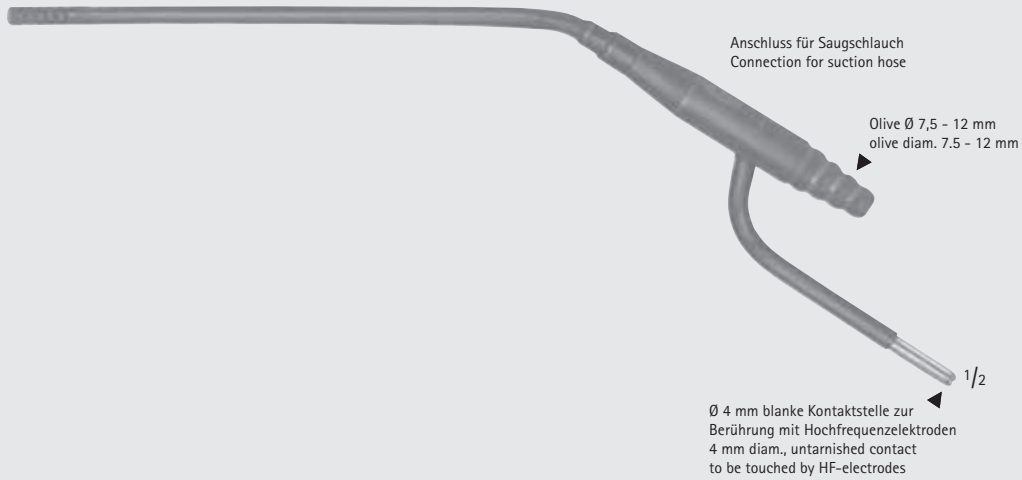

LANDOLT

GK550

5,0 mm

mit Saugunterbrecher und Mandrin,
sterilisierbar im Autoklav bis 143 °C (3 bar)

with finger cut-off and stylet,
can be sterilized in an autoclave up to 143 °C (3 bar)

GF

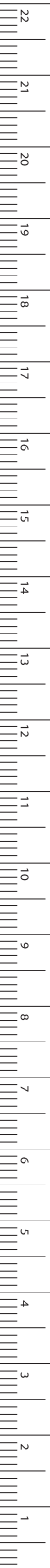

MILLIMETERS



INCHES



JG



Nierenschalen, Laborschalen
Kidney Trays, Bowls

Nierenschalen, Laborschalen – Kidney Trays, Bowls

Messbecher, Laborschalen, Nierenschalen

Medical Measures, Round Bowls, Kidney Trays

JG



JG514R

Medizinbecher, graduert, 0,05 Liter
Medical measure, graduated, 0.05 litre



JG515R

Messbecher, 0,1 Liter
Medical measure, graduated, 0.1 litre



JG516R

Messbecher, graduert, 0,25 Liter
Medical measure, graduated, 0.25 litre



JG518R

Messbecher, graduert, 1,0 Liter
Medical measure, graduated, 1.0 litre



	Inhalt (Liter) Capacity (litre)	Abmessungen in cm (oben x unten x Höhe) Dimensions in cm (upper x lower x height)
JG520R	0,02	4,0 x 2,8 x 1,9
JG521R	0,06	6,1 x 4,2 x 3,0
JG522R	0,16	8,3 x 5,4 x 4,1
JG523R	0,4	11,1 x 7,2 x 5,6
JG524R	1,0	15,1 x 10,0 x 7,3
JG525R	2,5	21,1 x 14,5 x 9,6

Laborschalen
Round bowls



JG504R	170 mm	6 3/4"
JG506R	250 mm	10"
JG508R	275 mm	10 3/4"

Nierenschalen
Kidney trays



Nierenschalen, Laborschalen – Kidney Trays, Bowls

Sterilisierzangen
Sterilizing Forceps

JR

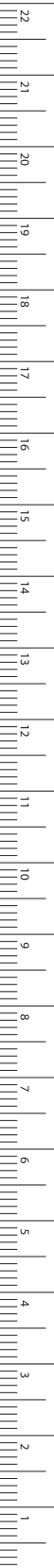

MILLIMETERS



1/3

CHEATTLE

JG820R

280 mm, 11"

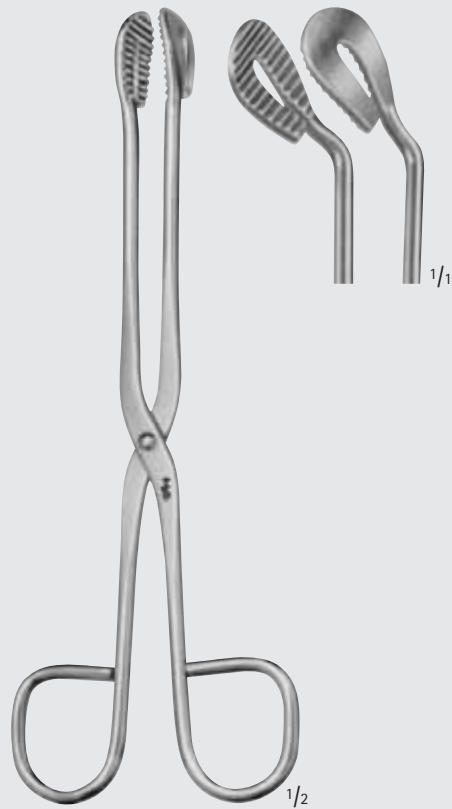

1/2

JG822R

210 mm, 8 1/4"



INCHES

JG



Instrumentenpflege, Reinigungshinweise
Care and Maintenance of Instruments

Instrumentenpflege, Reinigungshinweise – Care and Maintenance of Instruments

Reinigung – Desinfektion – Sterilisation von chirurgischen Instrumenten

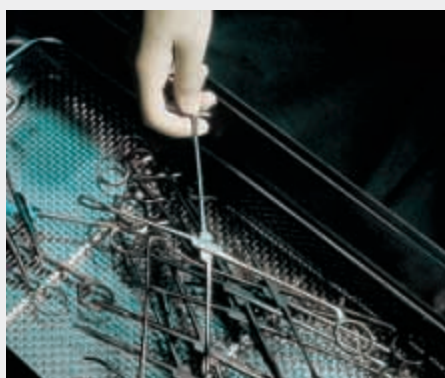

Bitte berücksichtigen Sie bei der Aufbereitung Ihrer hochwertigen Aesculap Instrumente die nachstehenden Empfehlungen.



Behandlung fabrikneuer Instrumente

Fabrikneue Instrumente sind vor der ersten Sterilisation bzw. Nutzung zu reinigen. Schutzkappen und Schutzfolien sind vollständig zu entfernen, z.B. bei Meißeln, Raspatorien oder mikrochirurgischen Instrumenten.

Nach jedem Gebrauch

- ☒ Kontaminiertes Instrument schnellstmöglich aufbereiten.
- ☒ Gelenkinstrument in einem 90°- Winkel öffnen.
- ☒ Bei maschineller Reinigung, Instrument auf reinigungsgerechte Siebkörbe legen (Spülschatten vermeiden).
- ☒ Zerlegbares Instrument in Einzelteile zerlegen.
- ☒ Vorzugsweise trocken entsorgen.
- ☒ Bei Nassentsorgung reinigungsaktive Desinfektionsmittel verwenden. Vor maschineller Reinigung und Desinfektion Instrument gründlich mit klarem, fließendem Wasser spülen.
- ☒ Falls nötig, Ultraschallbehandlung nach den Anweisungen des Geräteherstellers durchführen:
- ☒ als effektive mechanische Unterstützung bei manueller Reinigung,
- ☒ zur Vorbehandlung von Instrumenten mit angetrockneten Verschmutzungen vor der maschinellen Reinigung.
- ☒ Mikroinstrumente und Instrumente mit feinen Arbeitsenden sollten möglichst nicht im Ultraschall, sondern nur manuell oder maschinell gereinigt werden.

Bei maschineller Reinigung Mikro-Instrumente in geeigneten Lagerungshilfen lagern.

- ☒ Manuell oder maschinell reinigen. Herstellerangaben beachten.

Manuelle Reinigung/Desinfektion

- ☒ Instrument in ein geeignetes reinigungsaktives Desinfektionsmittel legen, so dass alle Oberflächen, Hohlräume, Lumen und Öffnungen bedeckt sind. Anweisungen des Desinfektionsmittelherstellers beachten.
- ☒ Nach der chemischen Desinfektion immer ausreichend und intensiv mit klarem und fließendem Wasser abspülen. Anweisungen des Desinfektionsmittelherstellers beachten.
- ☒ Anhaftende Verschmutzungen mit einer weichen Kunststoffbürste entfernen. Keine scheuernden Reinigungsmittel oder Metallbürsten verwenden.
- ☒ Lumen und Kanäle mit weichen Rundbürsten aus Kunststoff reinigen. Die Durchmesser von Lumen und Bürste müssen einander entsprechen.
- ☒ Schlusspülung mit destilliertem oder vollentsalztem Wasser durchführen.
- ☒ Instrument mit saugfähigem, weichem und fusselfreiem Tuch trocknen.
- ☒ Lumen und Kanäle mit Druckluft trocknen.

Maschinelle Reinigung/Desinfektion

- ☒ Bei der Programmwahl das Material (z.B. nichtrostender Instrumentenstahl, Aluminium) des zu reinigenden Instruments berücksichtigen. Anweisungen des Geräteherstellers beachten.
- ☒ Schlusspülung mit vollentsalztem Wasser durchführen.
- ☒ Ausreichende Trocknungsphase einhalten.
- ☒ Instrument sofort nach Beendigung des Programms aus der Maschine nehmen.



Instrumentenpflege, Reinigungshinweise – Care and Maintenance of Instruments

Reinigung – Desinfektion – Sterilisation von chirurgischen Instrumenten

Pflege/Prüfung

- ⌘ Instrument auf Raumtemperatur abkühlen lassen.
- ⌘ Bewegliche Teile (z.B. Gelenke und Schlüsse) mit sterilisierbarem, dampfdurchlässigem Pflegeöl leicht ölen (z.B. Sterilit Ölspray JG600 oder Sterilit Instrumenten-Öl JG598).
- ⌘ Nach jeder Reinigung, Desinfektion, Instrument prüfen auf Sauberkeit, Funktion und Beschädigungen, z.B. verbogene, zerbrochene, rissige, abgenutzte und abgebrochene Teile.
- ⌘ Beschädigtes und defektes Instrument aussortieren und ersetzen.

Packen

- ⌘ Instrument mit feinem Arbeitsende und/oder mikrochirurgisches Instrument in geeigneten Lagerungshilfen lagern.
- ⌘ Instrument mit Sperre in der ersten Raste fixieren.

Sterilisation

- ⌘ Sterilisieren mit Dampf, dabei folgendes beachten: Die Dampfsterilisation hat nach einem validierten Dampfsterilisationsverfahren (z.B. Sterilisator gemäß EN 285/ANSI/AAMI/ISO 11134-1993, ANSI/AAMI ST46-1993 und validiert gemäß EN 554/ISO 13683) zu erfolgen. Bei einer Anwendung des fraktionierten Vakuumverfahrens ist die Sterilisation mit dem 134°C -/ 2 bar-Programm bei einer Mindesthaltezeit von 5 Minuten durchzuführen.



Empfohlene Produkte



**STERILIT®
JG600**

Aesculap Ölspray in Sprühdose (FCKW-frei), zur Instrumentenpflege vor der Sterilisation. Physiologisch unbedenklich nach DAB und § 31 LMBG.



**STERILIT®
JG598**

Aesculap Instrumenten-Öl, zum Ölen der Schlüsse, Sperren usw. vor der Sterilisation. Physiologisch unbedenklich nach DAB und § 31 LMBG.

Ausführliche Informationen zur Aufbereitung individueller Aesculap Produkte finden Sie in der Datenbank "Aufbereitung/Gebrauchsanweisungen" im Internet unter:

www.aesculap-extra.net

Instrumentenpflege, Reinigungshinweise – Care and Maintenance of Instruments

Care and Maintenance of Surgical Instruments



Please observe the following recommendations for the care and maintenance of your high-quality Aesculap instruments.



Treatment of brand new Instruments

Brand new instruments must be cleaned before the first sterilization or use. Protective caps and protective films must be removed completely, for example in the case of chisels, raspatories or microsurgical instruments.

After each use

- ✂ Clean contaminated instruments as quickly as possible.
- ✂ Open instruments with a joint to a 90°- angle.
- ✂ For machine cleaning, place instrument in a wire basket suitable for the cleaning process (make sure cleaning solution and rinse water from machine comes into contact with all surfaces of the instrument).
- ✂ Completely dismantle any dismantlable instruments.
- ✂ Preferably dry removal tray in the OR.
- ✂ For wet removal always use an active cleaning disinfectant. Rinse the instrument thoroughly with clear, flowing water before machine cleaning and disinfecting.
- ✂ If necessary, treat with an ultrasound washer. Always use according to the manufacturer's instructions:
- ✂ for effective mechanical cleaning before manual cleaning,
- ✂ for pre-treatment of instruments with dried on contaminant before machine cleaning.

- ✂ Microsurgical instruments and instruments with fine working distal ends should not be treated with ultrasound. They should be cleaned either manually or in the washing machine. In case of cleaning in a machine please use a suitable storage rack.
- ✂ If cleaning manually or in a machine: always follow manufacturer's instructions. For detergents and other cleaning solutions.

Manual Cleaning/Disinfection

- ✂ Place instruments into a suitable disinfectant with active cleaning properties so that all surfaces, inner cavities, lumens and openings come into contact with the solution. Always follow the disinfectant manufacturer's instructions.
- ✂ After chemical disinfection, always rinse thoroughly with clear, flowing water. Always follow the instructions provided by the manufacturer of the disinfectant.
- ✂ Remove any contaminants still clinging to the instrument with a soft synthetic brush. Do not use a scouring or metal brush.
- ✂ Clean any lumens and conduits with soft, round, synthetic brushes. Please note, the lumen and the brush must have the same diameter.
- ✂ Final rinsing to be done with distilled or de-ionized water.
- ✂ Dry instrument with an absorbent, soft and lint-free cloth.
- ✂ Dry lumens and conduits with compressed air. Always use this method with caution.

Machine Cleaning/Disinfection

- ✂ Select the program according to the material of the instrument (e.g. stainless instruments, steel, aluminium) to be cleaned. Always follow the machine manufacturer's instructions.
- ✂ Final rinsing to be done with de-ionized or demineralized water.



Instrumentenpflege, Reinigungshinweise – Care and Maintenance of Instruments

Care and Maintenance of Surgical Instruments

- ⌘ Leave sufficient time for drying.
- ⌘ Remove the instrument from the machine immediately after the program is finished.

Care/Testing

- ⌘ Allow instruments to cool down to room temperature.
- ⌘ Lubricate movable parts (e.g. joints and ends) with special sterilization-capable, steam-permeable lubricant (e.g. Sterilit Oil Spray JG600 or Sterilit Instrument Oil JG598).
- ⌘ After each cleaning, disinfection process, check the instrument to make sure it is clean, that it functions properly and it has not suffered any damage, e.g. bent, broken, fractured or worn parts.
- ⌘ Remove any damaged and defective instruments and replace with functional items and send away any product which is damaged for repair.

Storage

- ⌘ Place instruments with the fine working end and/or microsurgery instruments in a suitable storage rack. Always secure micro instruments properly.
- ⌘ Where possible sterilize instruments on the first ratchet.

Sterilization

- ⌘ To steam sterilize, proceed as follows: Steam sterilization must be carried out according to a validated steam sterilization process (e.g. with a sterilizer meeting the specifications of EN 285/ANSI/AAMI/ISO 11134-1993, ANSI/AAMI ST46-1993 and validated according to EN 554/ISO 13683.). When using the fractional vacuum method, use the 134°C/-2 bar program for sterilization with a minimum hold time of 5 minutes.



Recommended Products



**STERILIT®
JG600**

Aesculap Oil Spray in aerosol can (ozone-friendly), for maintenance of instruments prior to sterilization. Physiologically inert acc. to DAB and S 31 LMBG (German Pharmacopoeia).



**STERILIT®
JG598**

Aesculap Instrument Oil, for box locks, ratchets etc. prior to sterilization. Physiologically inert acc. to DAB and S 31 LMBG (German Pharmacopoeia).

You will find detailed information about the reprocessing of individual Aesculap products in the data base "Reprocessing/Instructions for Use" on the internet:

www.aesculap-extra.net

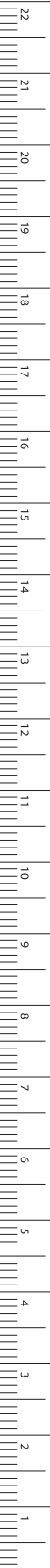



INCHES

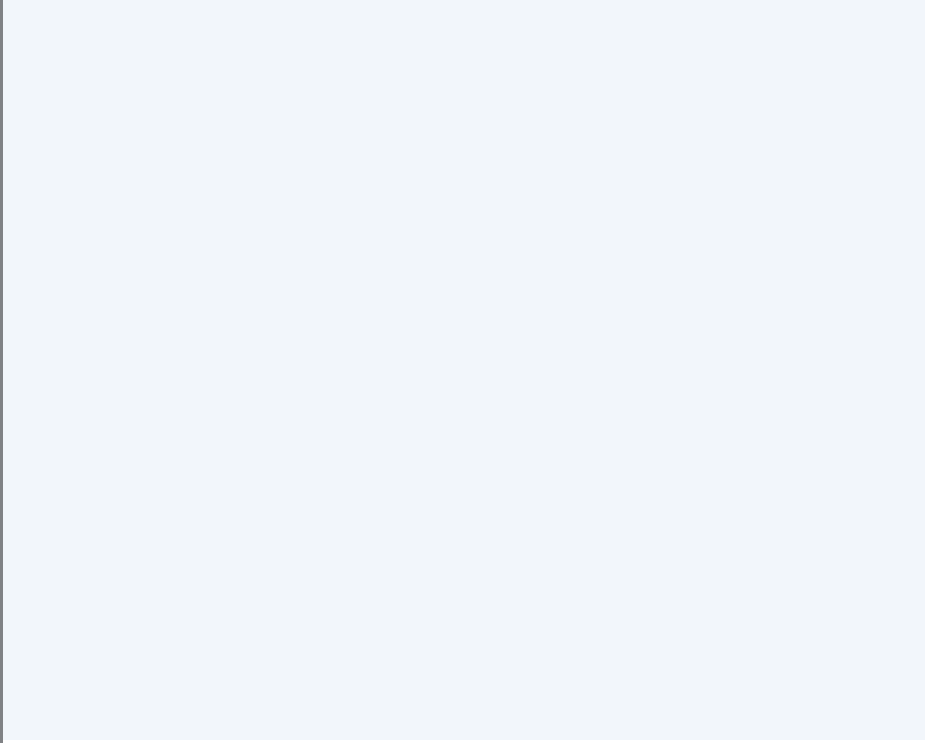

Alphabetischer Index
Nummerischer Index
Alphabetical Index
Numerical Index

Alphabetischer Index – Alphabetical Index

A

	Seite		Seite
A		ALLIS-ADAIR , Darm- und Gewebefasszangen	538
ABBEY , Schleimhaut-Resektionsnadel	515	ALLIS-THOMAS , Organ- und Gewebefasszangen	540
ABEL , Hakenzangen	677	ALLISON , Lungenspatel	424, 881
Abfallzangen	19	ALLPORT , Wundspreizer	458
Abortusküretten	713	ALM , Wundspreizer	457
Abortuslöffel	712	Amniotome	722
Abortuszangen	732-735	Amputationsmesser	28, 29, 917, 918
ABRAHAM , Tonsillennmesser	31	Amputationsretraktoren	920
ADAIR , Hakenzangen	674	Amputationssägen	921-923
Adapter, bipolar	522, 533	Analsonden	342, 343, 579
Saug-	1099	Analspreizer	573, 576
ADLERKREUTZ , Gefäß- und Tumorpinzetten	179	Anastomosenklemmen	559, 560, 843
ADSON , Arterienklemmen	225, 226	Anastomosenklemmen, Atraumatische-	563, 564, 566, 791-793, 799, 822, 823, 825, 828-831
Chirurgische Pinzetten	170	Rektum-	561, 562
DUROGRIP atraumatische Pinzetten	162	Anatomiescheren	68
Feine anatomische Pinzetten	151, 152	Anatomische Pinzetten	156-158
Feine chirurgische Pinzetten	168, 169	Anatomische Pinzetten, Feine-	151-155, 783
Hohlmeißelzangen	1031	ANDERSON-ADSON , Laminektomie-Wundspreizer	468
Laminektomie-Wundspreizer	468, 471	ANGLE , Drahtschneidezangen	1072
Monopolare Pinzetten	517	Anlegezangen, Bulldogklemmen	216, 786
Nadelhalter	301	Clip-	738-745
Nerv- und Gefäßhäkchen	358	Anuskope	572
Pinzetten, bajonettförmig	165	Aorta-Anastomosenklemmen, Atraumatische-	818, 819
Raspatorien	968	Aorta-Aneurysma-Klemmen, Atraumatische-	813-815
Saugkanülen	1094, 1095	Aortaklemmen, Atraumatische-	811, 816, 817, 832
Trepanationsfräser	1052	Aortenklappenhaken	884
ADSON-BABY , Wundspreizer	463	Aortenstanzen	852
ADSON-BROWN , Wundrandpinzetten	170	Appendektomieklemmen	557
AESCULAP , Biopsiezangen für Rektum	581	Approximatoren	211
DUROGRIP Nadelhalter	323	Approximatoren, Nerv-	212
Extensionsbügel	1061	Arterienfasszangen	196
Handbohrapparate	1054	Arterienklemmen	231-241
Korn- und Tupferzangen	10, 186	Arterienklemmen, Feine-	220-230
Plazentar- und Abortuszangen	734	Arteriotomie-Scheren	80
Tamponhalter	582	ASCH , Sekretlöffel	626
Waschzangen	10	Uterus-Sekretlöffel	697
AESCULAP-PRATT , Hakenzangen	680	ASSMUS , Nervstripper	1046
Organ- und Gewebefasszangen	198	ATRAUMATA, Anastomosenklemmen	791-793, 799, 808, 822, 823, 825, 828-831
Ahlen	1055, 1056	Aorta-Anastomosenklemmen	818, 819
ALEXANDER , Hohlmeißel	1001	Aorta-Aneurysma-Klemmen	813-815
Hohlmeißelzangen	1029	Aortaklemmen	811, 816, 817, 832
Raspatorien	974	Bronchusklemmen	812
Rippenraspatorien	863	Bulldogklemmen	218, 219, 787-790, 820, 821
ALLEN , Darmklemmen	547	Coarctationsklemmen	804, 826, 827
Osteophytenmeißel mit Schaber	962	Darmfasszangen	544, 545, 568
ALLENBERG , Durchzugsinstrumentarium für Gefäßprothesen	854	Darmklemmen	547, 548, 550, 552, 555
Gefäßklemmen	803	Druckklemmen	560, 612
Iliaca-Sperrer	475	Gallenblasenzangen	595
Wundspreizer	461	Gefäßclips	214, 215, 784, 785
ALLIS , Arterien- und Gewebefasszangen	196	Gefäßklemmen	794, 795, 801-803
Atraumatische Darmfasszangen	544, 568	Gewebefasszangen	544, 835-837
Atraumatische Organ- und Gewebefasszangen	836	Hämorrhoidenklemmen	584
Darm- und Gewebefasszangen	539		
Lungenfasszangen	839		



Alphabetischer Index – Alphabetical Index

A – B

	Seite		Seite
ATRAUMATA, Hysterektomie- und Vaginalklemmen	267	BABY-MOSQUITO (HARTMANN) , Arterienklemmen	220
Iliaca-Klemmen	807	BABY-OVERHOLT , Präparier- und Ligaturklemmen	244
Kapsel-fasszangen	622	BABY-ROUX , Wundhaken	379
Klemmzangen	272	BABY-SATINSKY , Anastomosenklemmen	843
Ligaturklemmen	797, 798	BABY-SENN-MILLER , Wundhaken	377
Magenklemmen	557	BACKHAUS , Tuchklemmen	203
Mehrzweckklemmen	791-793, 809, 810, 823-825, 828, 833, 834	BACKHAUS-KOCHER , Tuchklemmen	203
Nierenklemmen	608, 796	BAILEY , Rippenkontraktoren	877
Nierenstielklemmen	612	BAINBRIDGE , Darmklemmen	547
Organfasszangen	191, 544, 835-837	Bajonettförmige Pinzetten	165, 166
Ovarienzangen	687	BAKES , Gallengangdilata-tionsoliven	601
Pankreas-klemmen	796	BALFOUR , Bauchdeckenhalter	486-488
Parametriumklemmen	100, 268, 269	BALFOUR-BABY , Bauchdeckenhalter	485
Patent-Ductusklemmen	805, 806, 826, 827	BANE-HARTMANN , Hohlmeißelzangen	1028
Peripheralklemmen	805-807	BARNES-NEVILLE , Geburtszangen	729
Pinzetten	160, 161, 567, 782, 783	BARRAQUER , Lidsperrer	458
Polypenzangen	687	Mikro-Nadelhalter	283, 771
Präparierklemmen	797, 798	BARRÉ , Fadenhaltebügel	621
Profundaklemmen	798	Präparierklemmen	252, 619
Rektum-Anastomosenklemmen	563, 564, 566	Präparierschere	618
Ultra-Light-Pinzetten	159, 546, 781	Prostataretractor	452, 620
Vena-Cava-Klemmen	800	Urethraretractor	452, 620
Winkelklemmen	612	BARRON , Hämorrhoidal-Ligator	585, 586
Atriumhaken	882, 883	Saugkanülen	1097
AUFRICHT , Knochenraspeln	978	Skalpelli-griff	38
Aufsätze, Biopsie-	704, 705	BARSKY , Hauthäkchen	363
Augenpinzetten	168	BARTH , Scharfe Löffel	981
Augenscheren	49	Bauchdeckenhaken	437-439, 443-446
AUSTIN , Mikro-Knüpfpinzetten	140	Bauchdeckenhalter	447, 448, 482, 483, 485-495
AUVARD , Scheidenspekula	656	Bauchdeckenscheren	122
		Bauchdeckenvalven	482-484
		Bauchspatel	435, 436, 450, 451
		BAUMGARTNER , DUROGRIP Drahtspannzangen	312, 1067
		DUROGRIP Nadelhalter	308
		Nadelhalter	299
B		BEACHAM , Amniotom	722
BABCOCK , Atraumatische Darmfasszangen	544	Becher, Mess-	1108
Atraumatische Organ- und Gewebefasszangen	835	BECK , Rongeurs	902
Atraumatische Organ-, Gewebe- und Darmfasszangen	545	Becken-zirkel	720
Lungenfasszangen	839	BECKMANN-ADSON , Laminektomie-Wundspreizer	470
Organ- und Gewebefasszangen	540	BECKMANN-EATON , Laminektomie-Wundspreizer	471
BABY-ADSON , Präparier- und Ligaturklemmen	245	BEEBE , Blech- und Drahtscheren	129
BABY-ALLIS , Darm- und Gewebefasszangen	538	BEHRMAN , Uterus-Kanülen	717
BABY-COLLIN , Bauchdeckenhalter	482	Beinhautmesser	29, 918
BABY-CRILE (KOCHER) , Arterienklemmen	222	BELLUCI , Saugkanülen	1098
BABY-CRILE (PEAN) , Arterienklemmen	222	BENGOLEA , Arterienklemmen	228
BABY-CRILE-WOOD , DUROGRIP Nadelhalter	309	BENNETT , Knochenheber	945
BABY-KOCHER , Atraumatische Darmklemmen	547	BENSAUDE , Anuskope	572
Darmklemmen	547	BENSON , Pylorus-spreizer	557
BABY-METZENBAUM , DUROTIP Präparierscheren	96, 102	BERGER , Biopsiezangen	703
NOIR Feine Präparierscheren	105, 106	BERGMANN , Gipsscheren	1083
Präparierscheren	87	Hämmer	995
SuperCut Scheren	91	Skalpelle	26
BABY-MIKULICZ , Peritoneumklemmen	257	Wund- und Trachealhäkchen	364
BABY-MIXTER , Präparier- und Ligaturklemmen	244		

A-Z

Alphabetischer Index – Alphabetical Index

B

	Seite		Seite
BERKELEY-BONNEY , Hysterektomieklemmen	266	Bohrfutter, Hand-	1064
BERNHARD , Hakenzangen	674	Bolzenschneider	1078
Tuchklemmen	203	BONNER MODELL , Mikro-Knüpfpinzetten	139
BERRY , DUROGRIP Drahtspannzangen	312, 1068	BONNEY , Anatomische Pinzetten	158
Beschneidungsklemmen	631	Chirurgische Pinzetten	177
BETHUNE , Rippenscheren	857	Polypen- und Ovarienzangen	688
BEYER , Hohlmeißelzangen	1029, 1032	BOROWSKI , Aortenklappenhaken	884
Biegeinstrumente	1059	BORST , Fixierklemmen	842
Biegezangen für Kirschnerdrähte	1071	BOSE , Wund- und Trachealhäkchen	364
BIEMER , Anlegepinzetten für Gefäßclips	210, 211	Wundspreizer	456
Gefäßclips	210	Bougies, Harnröhren-	629, 630
Mikro-Approximatoren	211	BOWMAN , Sonden	347
Mikro-Venenscheren	51	BOYS-ALLIS , Arterien- und Gewebefasszangen	196
Nerv-Approximator	212	Darm- und Gewebefasszangen	538
BIEMER-MÜLLER , Approximatoren	211	BOZEMANN , Scheidenspekula	658
BIER , Amputationssägen	922	Tamponzangen	672, 673
Biopsie-Instrumente für Knochen	1057	Uterusscheren	119
Biopsieaufsätze	704, 705	BOZEMANN-DOUGLAS , Tamponzangen	673
Biopsieküretten, Endometrium-	698	BRAITHWAITE , Handdermatom	35
Biopsiezangen	699-704, 706	BRAND , Sehnenführungszangen	195
Biopsiezangen für Rektum	580-582	BRAUN , Hakenzangen	675, 678
Biopsiezangen, Aufsätze	581, 704, 705	Organ- und Gewebefasszangen	197
Bipolare Anschlusskabel	532, 533	Scheidenspekula	648
Bipolare Klemmen	531	Uterus-Depressor	671
Bipolare Koagulationspinzetten	523-527	BRAUN-STADLER , Dammscheren	124, 724
Bipolare Pinzetten	528, 529, 620	Sternumscheren	856
Bipolare Präparierscheren	530	BREISKY , Scheidenspekula	653
BIRCHER , Meniskus- und Knorpelzangen	1043	BRIDGE , Arterienklemmen	230
BIRCHER-GANSKE , Meniskus- und Knorpelzangen	1043	BRISTOW , Knochenhebel	933
BIRKETT , Arterienklemmen	228	BRODIE , Analsonden	579
BISHOP-HARMON , Chirurgische Pinzetten	168	Hohlsonden	342
BLAKE , Embolusfasszangen	846	BROM , Nerv- und Gefäßhäkchen	357
Gallensteinzangen	603	Bronchusklemmen	845
Uterusküretten	711	Bronchusklemmen, Atraumatische-	812
Blasenhalsspreizer	622	BROPHY , Chirurgische Pinzetten	173
Blasenspatel	496, 617	Feine anatomische Pinzetten	155
Blasensprenger	722	BROWN , Chirurgische Pinzetten	170
Blasenswundspreizer	496, 617	BRÜNINGS , Verlängerungsrohre	705
Blechscheren	129, 1072, 1073	Zungenspatel	4
Blechscheren, DUROTIP	1072	BRUNNER , Führungs-Hohlsonden	336
Bleihand	1049	Rektum-Anastomoseklemmen	561
BLOUNT , Wund- und Meniskushaken	400, 1045	Rippenscheren	858
BLUMENTHAL , Hohlmeißelzangen	1028	Unterbindungsnadeln	336, 1056
Blutschöpfer	453	Wundhaken	418, 419
Blutsperr	916	BRUNS , Gipsscheren	135, 138, 1084
BÖHLER , Extensionsbügel	1062	Scharfe Löffel	984, 987
Hohlmeißelzangen	1032	BRYANT , Tupferzangen	184
Knochensplitterzangen	1040	BUCHWALD , Zungenspatel	4
Bohrapparate, Hand-	1052, 1053	BUCK , Watteträger	349
Bohrdrähte	1058, 1059	BUCK-GRAMCKO , Knochenhebel	932
Bohrer, Knochen-	1055	BÜCHS , Raspatorien	972
Spiral-	1054	Wundhaken	407
Trepanations-	1052, 1053	Bügel, Extensions-	1060-1062
		Fadenhalte-	621



Alphabetischer Index – Alphabetical Index

B – C

A-Z

	Seite		Seite
Bulldogklemmen	216, 217, 786, 787	Chirurgische Nadeln	276-278
Bulldogklemmen, Atraumatische-	218, 219, 788-790, 820, 821	Chirurgische Pinzetten	170, 173-179
Bulldogscheren	76	Chirurgische Pinzetten, Feine-	168, 169, 171, 172
Bumerang Nadelhalter	326, 623	Chirurgische Scheren	71-75, 82, 122
BUMM , Plazentar- und Abortusküretten	713	Chirurgische Scheren, DUROTIP	93, 101
Uterusküretten	710	Cholezystektomieklappen	592
BUNNEL , Sehnendurchziehsonden	1048	CITELLI , Stanzen	892
Sehnenstripper	1047	CITELLI-BEYER Stanzen	892
BUNNELL , Handbohrapparat	1054	CLAR , Stirnlampen	3
BUNT , Sterilisierklammern	207	CLAUS VAN EICKEN , Unterbindungsnadeln	333
BURKE , Parametriumklappen	271, 692, 693	Clipanlegepinzetten	210, 211
BUSHE , Scharfe Löffel	986	Clipanlegezangen	738-745
		Clips, Atraumatische Gefäß-	214, 215, 784, 785
		Gefäß-	210, 213
		Titanligatur-	738, 740, 742, 744
C		CLOWARD , Wirbelkörperspreizer	481
CAIRNS , Arterienklappen	223	CLOWARD MODIF. , Wirbelsäulen-Wundspreizer	480
Durahäkchen	360	Coarctationsklappen, Atraumatische-	804, 826, 827
Knochendeckelelevatorien	930	COBB , Raspatorien	974
CAIRNS-DOTT , Feine anatomische Pinzetten	154	COBBETT , Handdermatom	35
CANNY-RYALL , Wundhaken	386	Colectomie-Klappen	554
CARBOTRAC Wundhaken	412	COLLER , Arterienklappen	224
Carotis Shunt Klappen	842	COLLEY , Atraumatische Patent-Ductusklappen	827
CARREL , Arterienklappen	220	COLLIN , Arterienklappen	241
CASPAR , Fadengabel	339	Atraumatische Darmfasszangen	544
Küretten	988, 989	Atraumatische Organ- und Gewebefasszangen	191, 837
Nerv- und Gefäßhäkchen	359	Bauchdeckenhalter	482
Raspatorien	969	Darmfasszangen	541
Rongeuere	904-906, 910	Klammerentfernungsangen	352
Scharfe Löffel	988	Korn- und Tupferzangen	189
Skalpellgriff	44	Nabelschnurklappen	724
Stößel	997	Nierenfasszangen	613
Wirbelsäulen-Wundspreizer	478, 479	Organ- und Gewebefasszangen	192
Wundhaken	408	Scheidenspekula	636
CASTANEDA , Atraumatische Anastomosen- und Mehrzweckklappen	791	Tupfer- und Schwammzangen	192
CASTROVIEJO , Augenscheren	49	Uterusfasszangen	688, 689
Chirurgische Pinzetten	168	Uterusküretten	711
DUROGRIP Nadelhalter	286, 287, 773, 774	Wundhaken	380
Mikro-Federscheren	48	Zungenzange	16
Mikro-Nadelhalter	282, 770	COLLIN-HARTMANN Wundhaken	378
CATLIN , Amputationsmesser	28, 917	COLLIN-POZZI , Hakenzangen	675
CAWTHORNE , Watteträger	347	CONE , Hemilaminektomiespreizer	469
Cerclagedraht	1065	CONVERSE , DUROGRIP Nadelhalter	307
CHADWICK , Feine Scheren	67	Nadelhalter	299
Zahnfleischscheren	67	Nasenflügelretractor	363
CHAMPIONNIÈRE , Knochenbohrer	1055	Wundhäkchen	363
CHANDLER , Elevatorien	930	COOLEY , Anastomosen- und Mehrzweckklappen	828
CHAPUT , Arterienfasszangen	196	Atraumatische Anastomosen- und Mehrzweckklappen	792, 793, 825
Darm- und Gewebefasszangen	538	Atraumatische Anastomosenklappen	822, 829, 831
CHARNLEY , Chirurgische Pinzetten	178	Atraumatische Aortaklamme	832
CHARRIÈRE , Amputationssägen	921, 922	Atraumatische Bulldogklappen	820, 821
CHEATTLE , Sterilisierzangen	1109	Atraumatische Coarctationsklappen	826, 827
CHERON , Korn- und Tupferzangen	189	Atraumatische Mehrzweckklappen	823, 824, 833

Alphabetischer Index – Alphabetical Index

C – D

A-Z

	Seite		Seite
COOLEY , Atraumatische Patent-Ductusklemmen	826	D	
Atraumatische Pinzetten	161, 783	Dammscheren	124, 724
Atriumhaken	882	DANDY , Arterienklemmen	221
Feine anatomische Pinzetten	155, 783	Darm-Zwillingsklemmen	556
Gefäßscheren	114	Darmfasspinzetten	543
Sternumsperrer	873	Darmfasszangen	538, 539, 541, 542
COOLEY MODIF. STRUCK , Atriumhaken	883	Darmfasszangen, Atraumatische-	544, 545, 568
COOLEY-BECK , Atraumatische Anastomosenklemmen	822	Darmklemmen	547-551, 553-555
COOPER , Chirurgische Scheren	73	Darmklemmen, Atraumatische-	547, 548, 550, 552, 555
Unterbindungsnadeln	334	Darmnadeln	278
CORYLLOS , Wundhaken	425	Darmpinzetten	180, 543
COTTLE , Bulldog-Scheren	76	Darmquetschklemmen	558
Fischschwanzosteotom	1001	Darmscheren	125, 127, 567
Fixierpinzetten	165	Darmspatel	435, 436, 450, 451
Hämmer	992	DARTIGUES , Nierenfasszangen	613
Hauthäkchen	361	Uterusfasszangen	689
Nasenflügelretractor	373	DAUBENSPECK , Scharfe Löffel	985
Osteotome	1001	DAVIDSON , Scapula Haken	426, 880
Raspatorien	965, 969	DAVIS , Gefäßspatel	850
Wund- und Venenhaken	373	DE BAKEY , Arteriotomiescheren	80
COTTLE-KNAPP , Präparierscheren	77	Atraumatische Anastomosen- und Mehrzweckklemmen	792
COTTLE-MASING , Präparierscheren	77	Atraumatische Aorta-Aneurysma-Klemmen	813-815
CRAFOORD , Arterienklemmen	229	Atraumatische Aortaklemmen	817
CRAFOORD MODIF. , Arterienklemmen	230	Atraumatische Bulldogklemmen	218, 219, 788-790
Gefäßklemmen	844	Atraumatische Coarctationsklemmen	804
CRAFOORD-SELLORS , Gefäßklemmen	844	Atraumatische Gefäßklemmen für Tangential-Verschluss	801
CRILE , Arterienklemmen	222, 224	Atraumatische Iliaca-Klemmen	807
Nadelhalter	305	Atraumatische Mehrzweckklemmen	809, 810
Nerv- und Gefäßhäkchen	357	Atraumatische Patent-Ductusklemmen	805
Wundhaken	379	Atraumatische Peripheralklemmen	805-807
CRILE-MURRAY , Nadelhalter	300	Atraumatische Pinzetten	160, 161, 546, 567, 782, 783
CRILE-WOOD , DUROGRIP Nadelhalter	309	Atraumatische Präparier- und Ligaturklemmen	798
Nadelhalter	300	DUROGRIP Nadelhalter	313, 314, 776, 777
CUSCO , Scheidenspekula	637, 638	DUROTIP Gallengangscheren	597
CUSHING , Chirurgische Pinzetten	173	DUROTIP Gefäßscheren	100
DUROGRIP Pinzetten	164	Femur-Wundspreizer	473
Feine anatomische Pinzetten	155	Gefäßdilatoren	847
Fräser	1052	Gefäßscheren	110
Nerv- und Gefäßhäkchen	357, 359	Offset-Schere	111
Rongeurs	902, 903, 906	Präparierschere	80
Wund- und Venenhaken	375, 376	Rippensperrer	870, 871
CUSHING-KOCHER , Wund- und Venenhaken	374	Saugkanülen	885, 1094
Cystikusklemmen	591, 593	DE BAKEY (LAMBERT MODIF.) , Atraumatische	819
CZERNY , Gallensteinzangen	604	Aorta-Anastomosenklemmen	
Hakenzangen	679	DE BAKEY (MORRIS MODIF.) , Atraumatische	811
Mastdarm-Rektum-Spekula	570	Aortaklemmen	
Organ- und Gewebefasszangen	197	Atraumatische Rektum-Anastomoseklemmen	563
Wundhaken	384	DE BAKEY (SEMB MODIF.) , Atraumatische Aorta-	813
		Aneurysma-Klemmen	
		DE BAKEY-BAINBRIDGE , Atraumatische Gefäßklemmen	794
		DE BAKEY-BECK , Atraumatische Vena-Cava-Klemmen	800
		DE BAKEY-HARKEN , Atraumatische Vena-Cava-Klemmen	800
		DE BAKEY-HESS , Bulldogklemmen	217, 787



Alphabetischer Index – Alphabetical Index

D

A-Z

	Seite		Seite
DE BAKEY-MC QUIGG-MIXTER , Atraumatische Präparier- und Ligaturklemmen	797	Dissektoren, Saug-	1103
		Tonsillensaug-	1103
DE BAKEY-MIXTER , Atraumatische Präparier- und Ligaturklemmen	797	Distraktor	1014
DE BAKEY-PEAN , Atraumatische Gefäßklemmen	795	DITTEL , Gallengangdilatoren	600
DE BAKEY-RUMEL , Atraumatische Präparier- und Ligaturklemmen	797	Metallbougie-Öffner	629
DE BAKEY-SATINSKY , Atraumatische Gefäßklemmen für Tangential-Verschluss	802	DIXON-LOVELACE , Arterienklemmen	225
DE LEE , Beckenzirkel	720	DOCKHORN , Wundhaken	408
DE MARTEL , Umführungsinstrumente	925	Doppelknopfsonden	346
DE MARTEL-WOLFSON , Anastomosenklemmen	559	Dosen, Nadel-	279
Schließzangen	559	DOYEN , Atraumatische Darmklemmen	548, 550
DEAVER , Chirurgische Scheren	75	Bauchdeckenhaken	446
Wundhaken	429-434	Darmklemmen	548-550
DEMEL , Drahtspannzangen	1065	Gallenblasenzangen	596
Drahtumführungsnadeln	1066	Hohlsonden	342
DENIS-BROWNE , Bauchdeckenhalter	490	Myomheber	690
Darmpinzetten	180, 543	Nadelhalter	299
Depressor, Uterus-	671	Polypen- und Ovarienzangen	687
DERF, DUROGRIP Nadelhalter	307	Raspatorien	976
Nadelhalter	299	Rippenraspatorien	861
Dermatome	35	Scheidenspekula	650, 651, 654
DERRA , Atraumatische Anastomosen- und Mehrzweckklemmen	793	Wundhaken	444
DERRA-COOLEY , Atraumatische Anastomosenklemmen	823	DOYEN-CHILD , Bauchdeckenhalter	447
DESCHAMPS , Unterbindungsnadeln	329-333	Drähte, Bohr-	1058, 1059
DESJARDINS , Gallengangsonden	599	Draht, Cerclage-	1065
Gallenkanal- und Cystusklemmen	591	Drahtbiegezangen	1069, 1071, 1073
Gallensteinlöffel	602	Drahtbürstchen	523
Gallensteinzangen	605	Drahtfazzzangen	1070, 1071
Präparier- und Ligaturklemmen	256	Drahtfazzzangen, DUROGRIP	1067
DESMARRES , Wund- und Venenhaken	373	Drahtsägen	924
DIADUST , Mikro-Nadelhalter	289, 291, 293, 295, 296, 759, 761, 763, 765-767, 769	Drahtscheren	129, 1072, 1073
Mikro-Pinzetten	145, 147, 149, 150, 753, 755, 757, 769	Drahtscheren, DUROTIP	100, 1072
Nadelhalter	297, 298, 767	Drahtschlingenelektroden	511, 512
DICK , Atraumatische Anastomosenklemmen	808	Drahtschneidezangen	1068, 1072-1078
Atraumatische Druckklemmen	560	Drahtspannzangen	1065
Atraumatische Klemmzangen	272	Drahtspannzangen, DUROGRIP	312, 1067, 1068
DIEFFENBACH , Bulldogklemmen	216, 786	Drahtumführungsnadeln	1066
DIETRICH , Atraumatische Aortaklemmen	816	Druckklemmen	584, 612
Bulldogklemmen	787	Druckklemmen, Atraumatische-	612
Gefäßscheren	110	Ductusklemmen, Atraumatische-	805, 806, 826, 827
DIETRICH-HEGEMANN , Gefäßscheren	110	DUNHILL , Arterienklemmen	222, 227
Dilatatoren, Gallengang-	600, 601	DUPLAY , Hakenzangen	677
Gefäß-	847, 848	Korn- und Tupferzangen	185
Nabelschnur-	724	Durahäkchen	360-363
Tracheal-	474	Durascheren	112
Uterus-	662-666	Durchzugsinstrumente für Gefäßprothesen	853, 854
DINGMANN , Knochenhalte-zangen	1017	DURHAM , Wundhaken	405
DINGMANN MODIF. , Knochenhalte-zangen	1017	DUROGRIP, Drahtfazzzangen	1067
Dissektoren	849, 850, 928, 929	Drahtspannzangen	312, 1067, 1068
Dissektoren, Phlebo-	889	Knochenraspeln	979
		Nadelhalter	286, 287, 307-310, 312-321, 324, 568, 773-779
		Nadelhalter mit Schere	311
		Nahtpinzetten	163, 178
		Pinzetten	162-164, 543

Alphabetischer Index – Alphabetical Index

D – F

A – Z

	Seite		Seite
DUROTIP , Draht- und Blechscheren	100, 1072	F	
Gallengangsscheren	597	Fadengabel	339
Ligaturscheren	104	Fadenhaltebügel	621
Scheren	92–100, 103	Fadenhaltezangen	326, 622
Scheren mit Wellenschliff	101–104	Fadenklemmen	213
Uterusscheren	103	Fadenmesser	43
DUVAL , Darmfasszangen	542	Fadenpinzetten	158
Darmpinzetten	180, 543	Fadenscheren, DUROTIP	92, 101
Lungenfasszangen	839	Mikro-	60, 768
DUVAL-COLLIN , Darmfasszangen	541	FARABEUF , Knochenhaltezangen	1019
		Raspatorien	971
		Wundhaken	379
		FARABEUF-COLLIN , Raspatorien	971
E		FARABEUF-LAMBOTTE , Knochenhaltezangen	1019
EAST GRINSTEAD (WARD) , Flachmeißel	1002	FARRELL , Watteträger	348, 350
Osteotome	1002	Fasszangen, Arterien-	196
EASTMAN , Flachmeißel	1002	Atraumatische Darm-	544, 568
ECHLIN , Hohlmeißelzangen	1033	Atraumatische Gewebe-	544, 545, 835–837
ECKHOFF , Zeichenfeder	25	Atraumatische Kapsel-	622
Einmal-Elektrodenhandgriffe	508	Atraumatische Organ-	191, 544, 545, 835–837
Einmalskalpelle	22–24	Darm-	538, 539, 541, 542
Elektrische Haarschneidemaschinen	9	Draht-	1070, 1071
Elektroden, Drahtschlingen-	511, 512	Draht-, DUROGRIP	1067
Kugel-	510, 511, 513	Embolus-	846
Lanzetten-	509	Gewebe-	193, 196–199, 538–540, 543
Messer-	509, 511	Hämorrhoiden-	585
Nadel-	509–513	Ligamentum-flavum-	913
Platten-	510	Lungen-	838, 839
Schlingen-	509, 513	Nieren-	613
Elektrodenhandgriffe	506–508, 513	Organ-	193, 197–199, 540, 543
Elektrodenhandgriffe, Einmal-	508	Rippen-	859
Elevatorien	930, 931, 963	Sehnen-	194
Elevatorien, Knochendeckel-	930	Tumor-	909
Embolusfasszangen	846	Uterus-	688, 689
EMMET , Fistelhaken	372	Vorhaut-	625
Korn- und Tupferzangen	189	FAURE , Biopsiezangen	700
Endarterektomiestripper	851	Peritoneumklemmen	260
Endometrium-Biopsieküretten	698	FAVOLORO , Gefäßscheren	111
Endospekula für Harnröhre und Cervix	667	FEILCHENFELD , Splitterpinzetten	181
ENGEL , Gipssägen	1082	Feilen, Knochen-	978–980
ENGL. MODELL , Tuckklemmen	201	Nagel-	13
Entfernungshaken, I.U.D.	697	Feine anatomische Pinzetten	153, 783
Enukleationsscheren	77	Feine Präparierscheren	62, 63, 76, 78, 80, 81
EPPENDORF , Biopsiezangen	703	Feine Präparierscheren, NOIR-	105
Ersatzklingen	9	Feine Scheren	12, 61, 63–70
ESMARCH , Gipsmesser	1082	Feine Scheren, DUROTIP	92
Gipscheren	135, 138, 1083	Femur-Wundspreizer	473
Staubbinde	916	FERGUSSON , Druckklemmen	584
Explorationshäkchen	359	Knochenhaltezangen	1018
Extensionsbügel	1060–1062	Saugkanülen	1095, 1096, 1102
Extraktionszangen für Bohrdrähte	1070, 1071	FERGUSSON-ACKLAND , Mundsperrer	14
Extraktoren, Phleb-	889	FERRIS-SMITH , DUROGRIP Pinzetten	163
		FICKLING , Arterienklemmen	237
		Finger-Goniometer	8



Alphabetischer Index – Alphabetical Index

F - G

A - Z

	Seite		Seite
Fingerringsägen	1079	Gallenblasenzangen, Atraumatische-	595
FINOCHIETTO, DUROGRIP Nadelhalter	318	Gallengang-Klemmzangen	590
Präparier- und Ligaturklemmen	251, 840	Gallengangdilatoren	600, 601
Rippensperrer	866-868	Gallengangscheren	596, 597
Thoraxsperrer	864, 865	Gallengangscheren, DUROTIP	597
FINOCHIETTO-BURFORD Rippensperrer	869	Gallengangsonden	598, 599
FINSEN , Wundspreizer	456	Gallenkanal-Klemmzangen	590-593
FINSEN MODIF. , Wundspreizer	456	Gallensteinlöffel	602
FINSTERER Saug- und Spülkanülen	886, 1104	Gallensteinzangen	603-605
FISCH , Dura- und Hauthäkchen	363	GARRETT , Gefäßdilatoren	848
Fischschwanzosteotom	1001	Geburtslöffel	730
Fistelhaken	372	Geburtszangen	726-729
Fistelmesser	30	Gefäß-Spülkanülen	846
Fistelsonden	343, 579	Gefäßclips	210, 213
Fixierklemmen	842	Gefäßclips, Atraumatische-	214, 215, 784, 785
Fixierpinzetten	165	Gefäßdilatoren	847, 848
Flachmeißel	998-1003, 1006, 1007, 1010	Gefäßhäkchen	356-359
Flachzangen	1069, 1070	Gefäßklemmen	844
FÖRSTER-BALLENGER Gallenblasenzangen	594	Gefäßklemmen, Atraumatische-	794, 795, 801-803
Tupfer- und Schwammzangen	190	Gefäßprothesen-Durchziehungen	854
FOMON , Knochenfeilen	979	Gefäßscheren	63, 78, 108-115, 751
Knochenraspeln	979	Gefäßscheren, DUROTIP	100
Nasenflügelretractor	370	Gefäßspatel	849, 850
Nasenflügelscheren	77	GELPI , Hautspreizer	473
FORMBY , Saugkanülen	1097	Vulva-Spreizer	473, 659
FOWLER , Tonsillennmesser	31	GEMINI , Präparier- und Ligaturklemmen	248
Fräser, Trepanations-	1052, 1053	GERALD , Feine anatomische Pinzetten	154
FRASER-KELLY (CRILE) , Arterienklemmen	226	Feine chirurgische Pinzetten	172
FRAZIER , Hauthäkchen	360	Mikro-Pinzetten	149, 757
Saugkanülen	1096	Gestationskalkulator	720
FREER , Dissektoren	849	Gewebe-Auffangsieb	714, 1090
Flachmeißel	998	Gewebefasspinzetten	179, 180, 543
Hauthäkchen	361	Gewebefasszangen	190, 192, 193, 196-199, 538-540, 543
Hohlmeißel	998	Gewebefasszangen, Atraumatische-	544, 835-837
Raspatorien	963-965	Gewebekralle	363
FREER-YASARGIL , Raspatorien	965	GIERTZ-STILLE , Rippenscheren	858
Fremdkörperzangen	200, 626, 672	GIGLI , Drahtsägen	924
FRIEDMAN , Hohlmeißelzangen	1026	GILLIES , DUROGRIP Nadelhalter mit Schere	311
FRITSCH , Bauchdeckenhaken	445	Feine anatomische Pinzetten	154
FRYKHOLM , Hohlmeißelzangen	1033	Feine chirurgische Pinzetten	172
FUCHSIG , Arterienklemmen	225	Hauthäkchen	362
Führungs-Hohlsonden	336-338	Monopolare Pinzetten	517
Führungsnadeln	353	Nadelhalter mit Schere	304
		Osteotome	999
		Saugkanülen	1101
G		Gipsabreißzangen	1087
GABRIEL , Hämorrhoidal-Kanülen	587	Gipsmesser	1082
Hämorrhoidal-Spritze	587	Gipssägen	1082
Rektum-Spekula	573	Gipsscheren	134, 135, 1083-1086
GALABINS , Uterussonden	670	Gipsspreizer	1087
GALLAHER , Knochenfeilen	978	GLASSER , DIADUST Mikro-Nadelhalter	296, 766
Gallenblasenscheren	596	Glocken, Saug-	725
Gallenblasenzangen	594-596	GLOVER , Atraumatische Anastomosenklemmen	799

Alphabetischer Index – Alphabetical Index

G - H

A - Z

	Seite		Seite
GLOVER , Atraumatische Bulldogklemmen	218, 219, 788, 789	Hämorrhoidal-Ligatoren	585, 586
GLUCK , Rippenscheren	857	Hämorrhoidal-Spritze	587
GOELET , Wundhaken	386	Hämorrhoidenklemmen	583
GOLDMAN-FOX , Zahnfleissschere	92	Hämorrhoidenklemmen, Atraumatische-	584
GOLIGHER , Bauchdeckenhalter	488	HAIGHT , Rippensperrler	867
Goniometer Finger-	8	HAJEK , Hämmer	993
GORNEY , Präparierscheren	81	Spülkanülen	598
Saugdissektoren	1103	Wundhaken	385
SuperCut Scheren	90	HAJEK-KOFLER Stanzen	893, 894
GOSLEE , Drahtbiegezangen	1069	HAKANSSON , Hohlmeißelzangen	1028
GOSSET , Bauchdeckenhalter	485	Haken, Aortenklappen-	884
GOULIAN , Handdermatom	34	Atrium-	882, 883
GOURDET , Uteruslöffel	707	I.U.D.-Entfernungs-	697
GRAEFE , Chirurgische Pinzetten	170	Meniskus-	1045
Haut- und Wundhäkchen	360	Scapula-	880
Nerv- und Gefäßhäkchen	356	Hakenzangen	674-684
Präparierscheren	76	HALLE , Dissektoren	849
GRAVE , Scheidenspekula	640	Elevatorien	963
GRAY , Cholezystektomieklemmen	592	Scharfe Löffel	985
Präparier- und Ligaturklemmen	256	HALSEY , DUROGRIP Nadelhalter	307, 308
GREEN-ARMYTAGE , Uterus-Klemmzangen	730, 731	Nadelhalter	299
GREENE , Wundhaken	406	HALSTED , Arterienklemmen	225
GREGORY , Profundaklemmen	798	HALSTED-MOSQUITO Arterienklemmen	220, 226
GREY-TURNER , Arterienklemmen	227	Halter, Bauchdecken-	482, 483, 485-495
Griffe, Saug-	1092	Handbohrapparate	1052-1054
Skalpell-	38-41, 44, 45, 618	Handbohrfutter	1064
GROSS , Korn- und Tupferzangen	10, 185	Handdermatome	34, 35
Waschzangen	10	Handfixierplatte	1049
GRUENWALD , Pinzetten, bajonettförmig	166	Handgriffe, Elektroden-	506-508, 513
DUROGRIP Pinzetten	164	modular	959
GULEKE , Hohlmeißelzangen	1030	Harnröhrenbougies	629, 630
GUTHRIE , Haut- und Wundhäkchen	360	HARRINGTON , Lungenspatel	878
GUYON , Atraumatische Nierenklemmen	608	Wundhaken	422
Metallbougie-Öffner	630	HARRINGTON-PEMBERTON Lungenspatel	879
Nierenklemmen	608-610	Wundhaken	423
GWILLIAM , Hysterektomieklemmen	266	HARTMANN , Atraumatische Darmklemmen	548
Gynäkologiescheren	117-121	Darmklemmen	548
		Stimmgabeln	6
		Watteträger	351
H		HARVEY , Draht- und Blehscheren	129, 1073
Haarschneidemaschinen, elektrische-	9	Drahtschneidezangen	1074
HAASE , Repositionszangen	1014	HARVEY JACKSON , Laminektomie-	470
HABERER , Bauch- und Darmspatel	450	HASSON , Wundhaken	428
Häkchen, Dura-	360-363	Hauthäkchen	360-363
Explorations-	359	Hautkralle	363
Gefäß-	356-359	Hautspreizer	473
Haut-	360-363	Hautstanzen	33
Nerv-	356-359	HEANEY , Atraumatische Hysterektomie- und Vaginalklemmen	267
Samenstrang-	625	DUROGRIP Nadelhalter	315
Tracheal-	364-366	Hysterektomieklemmen	261
Hämmer	992-996	Nadelhalter	302
Hämorrhoidal-Fasszangen	585	Scheidenspekula	652
Hämorrhoidal-Kanülen	587	Uterusküretten	711
		Wundhaken	652



Alphabetischer Index – Alphabetical Index

H - J

A - Z

	Seite		Seite
HEANEY MODIF. , Hysterektomieklemmen	261	Hohlsonden	342, 929
HEANEY-BALLENTINE , Hysterektomieklemmen	262	Hohlsonden, Führungs-	336-338
HEANEY-REZEK , Hysterektomieklemmen	261	HOHMANN , Knochenheber	940
HEATH , Hämmer	996	HOHMANN-ALDINGER , Knochenheber	943
Klammerentfernungszangen	352	HOLZBACH , Bauchdeckenhalter	483
Hebel, Knochen-	932-945, 947-959	Hysterektomieklemmen	265
Luxations-	945	HOPT , Atraumatische Klemmen für Nieren- und Pankreaseingriffe	796
Heber, Myom-	690	Hornhautpinzetten	151
HEGAR , DUROGRIP Nadelhalter	310	HOUSE , Saug- und Spülkanülen	1104
Nadelhalter	302	Saugadapter	1099
Uterus-Dilatatoren	662-664	HOWARTH , Raspatorien	964
HEGAR-MAYO , DUROGRIP Nadelhalter	310	HUDSON , Chirurgische Pinzetten	170
HEGAR-MAYO-SEELEY , DUROGRIP Nadelhalter	309	Feine anatomische Pinzetten	151
HEGAR-OLSEN , DUROGRIP Nadelhalter mit Schere	311	Handbohrapparate	1052
Nadelhalter mit Schere	304	Trepansfräser	1052
HEGAR-OLSEN MODIF. LANGE , DUROGRIP Nadelhalter mit Schere	311	HUDSON DOWNS , Handbohrapparate	1053
HEGENBARTH , Klammeranlegepinzetten	352	Trepansfräser	1053
HEIMING , Nierensteinzangen	614	Hüftretraktoren, MIOS-	947-959
HEISS , Arterienklemmen	227	HUMBY , Handdermatom	35
Präparier- und Ligaturklemmen	250	HUNTER , Splitterpinzetten	181
HEISTER , Mundsperrerr	14	HURD , Unterbindungsnadeln	332
HELLBERG/KUPKA , DUROGRIP Nadelhalter	321, 775	Hysterektomieklemmen	260-266, 270
Hemilaminektomiespreizer	469	Hysterektomieklemmen, Atraumatische-	267
HEMINGWAY , Scharfe Löffel	982	Hysterektomiescheren, DUROTIP	100
HENCKEL-TILLEY , Rongeur	900		
HENDERSON , Wundspreizer	465	I	
HENNIG , Gipsspreizer	1087	Iliaca-Klemmen, Atraumatische-	807
HERFF , Blasensprenger	722	Iliaca-Sperrerr	475
HERRICK , Nierenstielklemmen	611	INGE , Wirbelkörperspreizer	481
HERTZLER , Bauchdeckenhalter	485	Instrumente, Tunnelierungs-	853
Rippensperrerr	485, 866	Instrumenten-Öl	1112
HERZ , Sehnenfasszangen	194	Inzisions-Scheren	75
HESS , Nervwurzelhaken	376	Irisscheren	61, 64
HEY GROVES , Knochenhalte-zangen	1022	IRWIN , Wundspreizer	467
HEYWOOD-SMITH , Gallenblasenzangen	594, 595	ISRAEL , Wundhaken	393
Hämorrhoidenklemmen	583	IVES-FANSLER , Anuskope	572
Organ- und Gewebefasszangen	193		
Polypen- und Ovarienzangen	685, 686	J	
Tupfer- und Schwammzangen	192, 193	JACKSON , Scheidenspekula	650
Zungenzange	16	Sehnenfasszangen	194
HEYWOOD-SMITH MODIF. , Gallenblasenzangen	596	JACKSON-BURROWS , Chirurgische Pinzetten	177
Hämorrhoidenklemmen	583	Wundspreizer	472
Tupfer- und Schwammzangen	192	JACOBS , Hakenzangen	682
Zungenzange	16	JACOBSON , Arterienklemmen	226
HIBBS , Osteotome	1004	Mikro-Federscheren	52
Retraktor	946	Mikro-Nadelhalter	282, 770
HILL , Raspatorien	965	Scharfe Löffel	981
HÖSEL , DUROGRIP Nadelhalter	324	JÄGER , Hauthäkchen	362
Wundhaken	411, 569	Sehnen- und Kreuzband- Durchzieh-zangen	195
Hohlmeißel	998-1001, 1003, 1007-1011		
Hohlmeißel, Skoliose-Operationen	1008		
Spongiosa-	1010		
Hohlmeißelzangen	860, 1026-1037		

Alphabetischer Index – Alphabetical Index

J – K

A – Z

	Seite		Seite
JAMESON , Nadelhalter	302	KELLY , Feine Scheren	70
Präparierscheren	79	Plazentar- und Abortuszangen	734
SuperCut Scheren	90	Polypen- und Ovarienzangen	685
JAMESON-WERBER , Präparierscheren	79	Proktoskop	573
JANSEN , Pinzetten, bajonettförmig	165	Sphinkteroskope	572
Hohlmeißelzangen	1028, 1029	Tupfer- und Schwammzangen	193
Raspatorien	972	Wundhaken	415, 439
Scharfe Löffel	981, 982	Zahnfleischscheren	70
JAVID , Carotis Shunt Klemmen	842	KERN-LANE , Knochenhaltezangen	1020, 1021
JEFFERSON , Feine anatomische Pinzetten	152	KERN-MINI , Knochenhaltezangen	1021
Feine chirurgische Pinzetten	169	KERPEL , Scharfe Löffel	983
Wundspreizer	464	KERRISON , Stanzen	892, 896-898
JENKNER , Tunnelierungs- und Durchzugsinstrumentarium für Gefäßprothesen	853	KERSTING , Atraumatische Rektum-Anastomosenklemmen	564
JOHNS-HOPKINS , Anlege- und Abnehmezangen	216, 786	KEY , Raspatorien	972
Bulldogklemmen	216, 786	KEYES , Hautstanzen	33
JOLL (FRIEDMAN) , Thyreoid- und Vulva-Spreizer	472, 659	KEYES MODIF. , Hautstanzen	33
JONES , Tuchklemmen	201	KIEBACK , Parametriumscheren	120, 121, 692, 693
JONESCO , Unterbindungsadeln	333	Präparier- und Ligaturklemmen	254
JOSEPH , Feine Scheren	61, 70	Ureter-Tunnelier-Klemmen	691
Haut- und Wundhäkchen	362	KIELLAND , Geburtszangen	726
Knochenfeilen	978	KILLIAN , Knochenscheren	116
Plastikmesser	32	Mastdarm-Rektum-Spekula	570
Plastikscheren	70	Raspatorien	964
Raspatorien	961	Sonden	347
SuperCut Scheren	90	KILNER, DUROGRIP Nadelhalter	308
Zahnfleischscheren	70	Feine Präparierscheren	76
JUDD-ALLIS , Organ- und Gewebefasszangen	540	Hauthäkchen	361
		Nadelhalter	300
		Nasenflügelretractor	363
		Präparierscheren	79
		Wundhaken	377, 383
		KINGS COLLEGE HOSPITAL , Watteträger	349
K		KIRSCH , Wundhaken	405
Kabel, bipolare	532, 533	KIRSCHNER , Bauchdeckenhalter	494, 495
monopolare	506, 513, 522	Bohrdrähte	1058, 1059
KADER , Bauch- und Darmspatel	451	Extensionsbügel	1060
Kalkulator, Gestations-	720	Führungs Hohlsonden	338
KALLMORGEN , Scheidenspekula	646	Klammeranlegepinzetten	352
KANTROWITZ , Präparier- und Ligaturklemmen	252	Klammerentfernungszangen	352
Kanülen, Gefäß-Spül-	846	Klammern, Knochenhalte-	1025
Hämorrhoidal-	587	Sterilisier-	207
Koagulations-	1105	Wund-	352
Pudendusnästhesie-	721	KLAPP , Sehnenscheidenhaken	373
Saug-	885, 886, 1091-1102, 1104, 1105	Kleiderscheren	132-135, 1082
Spül-	598, 886, 1104	KLEINERT-KUTZ , Hauthäkchen	361
Sternumpunktions-	634, 855	Sehnendurchzieh-zangen	195
Uterus-	716, 717	KLEINSCHMIDT , Appendektonmieklemmen	557
Kapsel-fasszangen, Atraumatische-	622	Klemmen, Anastomosen-	559, 560, 843
Kapselscheren	89	Appendektomie-	557
Katheter, Urologie-	627	Arterien, Feine-	220-230
Uterusspül-	717	Arterien-	231-241
Kathetereinführungszangen	15	Atraumatische Anastomosen-	791-793, 799, 808, 822,
KAZANJIAN , Knochensplitterzangen	1038		823, 825, 828-831
Kehlkopfspiegel	5	Atraumatische Aorta-	811, 816, 817, 832
KELLY , Arterienklemmen	221		



Alphabetischer Index – Alphabetical Index

K

A-Z

	Seite		Seite
Klemmen, Atraumatische Aorta-Anastomosen-	818, 819	Klemmen, Quetsch-	558
Atraumatische Aorta-Aneurysma-	813-815	Rektum-Anastomosen-	561, 562
Atraumatische Bronchus-	812	Samenstrang Fixier-	625
Atraumatische Bulldog-	218, 219, 788-790, 820, 821	Schlauch-	17
Atraumatische Coarctations-	804, 826, 827	Sinus-	184
Atraumatische Darm-	547, 548, 550, 552, 555	Tonsillen-	240
Atraumatische Druck-	560, 612	Tuch-	201-206
Atraumatische Gefäß-	794, 795, 801-803	Ureter-Tunnelier-	691
Atraumatische Hämorrhoiden-	584	Venenkomplex-	619
Atraumatische Hysterektomie-	267	Winkel-	612
Atraumatische Iliaca-	807	Klemmenhalter	559
Atraumatische Ligatur-	797, 798	Klemmzangen	273
Atraumatische Magen-	557	Klemmzangen, Atraumatische-	272
Atraumatische Mehrzweck-	791-793, 809, 810, 823- 825, 828, 833, 834	Uterus-	730, 731
Atraumatische Nieren-	608, 796	KLIMA-ROSEGGER Sternal-Punktionskanülen	634
Atraumatische Nierenstiel-	612	Klingen, Mikrochirurgische-	45
Atraumatische Pankreas-	796	Skalpell-	42, 43
Atraumatische Parametrium-	100, 268, 269	KLINIKUM BERLIN , Schlauchklemme	16
Atraumatische Patent-Ductus-	805, 806, 826, 827	KLINKENBERG-LOTH Gefäßscheren	115
Atraumatische Peripheral-	805-807	Knochenbiopsie-Instrumente	1057
Atraumatische Präparier-	797, 798	Knochenbohrer	1055
Atraumatische Profunda-	798	Knochendeckelelevatoren	930
Atraumatische Rektum-Anastomosen-	563, 564, 566	Knochenfeilen	978-980
Atraumatische Vena-Cava-	800	Knochenhaken	387, 388
Atraumatische Winkel-	612	Knochenhalteklammern	1025
Beschneidungs-	631	Knochenhaltezangen	1016-1024
Bipolare-	531	Knochenhaltezangen, selbstzentrierend	1023
Bronchus-	845	Knochenhebel	932-945, 947-959
Bulldog-	216, 217, 786, 787	Knochenraspeln	978-980
Carotis Shunt-	842	Knochenraspeln, DUROGRIP	979
Cholezystektomie-	592	Knochenscheren	116
Colectomie-	554	Knochensplitterzangen	859, 1038-1042
Cystikus-	591, 593	Knochenstanzen	892-898
Darm-	547-551, 553-555	Knochenstanzen, NOIR	897
Darm-Zwillings-	556	Knöchelfasszangen	1016
Druck-	584, 612	Knopfsonden	345, 346
Faden-	213	Knorpelmesser	29, 918
Fixier-	842	Knorpelritzmesser	32
Gallengang-	590	Knorpelscheren	81
Gallenkanal-	590-593	Knorpelzangen	1043
Gefäß-	844	KNOWLES Verbandscheren	131
Hämorrhoiden-	583	Knüpfpinzetten, Mikro-	139, 140, 143
Hysterektomie-	260-266, 270	Koagulationskanülen	521, 1105
Ligatur-	244-256, 840, 841	Koagulationspinzetten, bipolar	523-527
Magen-Zwillings-	556	KOCHER Arterienklemmen	235
Monopolare-	520	Atraumatische Darmklemmen	552
Nabelschnur-	724	Darmklemmen	549, 551
Nieren-	608-610	Führungs-Hohlsonden	337
Nierenstiel-	611, 612	Knochen- und Wundhaken	387
Parametrium-	270, 271, 692, 693	Kropflöffel	453
Penis-	625	Unterbindungsadeln	335
Peritoneum-	257-260	Wund- und Venenhaken	374
Präparier-	244-256, 619, 840, 841	Wundhaken	390, 403, 409
		KOCHER-LANGENBECK Wundhaken	396

Alphabetischer Index – Alphabetical Index

K – L

A – Z

	Seite		Seite
KOCHER-OCHSNER Arterienklemmen	236	LAMBERT-KAY , Atraumatische Aorta-Anastomosenklemmen	819
KOCHER-WAGNER Wundhaken	410	LAMBOTTE , Knochenhaltezangen	1024
KÖNIG , Elevatorien	930	Osteotome	1001, 1005
Führungs-Hohlsonden	337	Raspatorien	973
Raspatorien	960	Rippenraspatorien	863
Wund- und Venenhaken	374	Laminektomie-Wundspreizer	468-471, 476
KÖRTE , Wundhaken	392, 436	Laminektomiespreizer	477, 478
KÖRTE-WAGNER Wundhaken	392	LANCASTER , Lidsperrer	458
KOFLER , Stanzen	894	LANDAU , Scheidenspekula	653
KOGAN , Endospekula für Harnröhre und Cervix	667	LANDOLT , Eukleationsscheren	77
Komprimeter	916	Koagulations-Saugkanülen	521, 1105
Konisationsmesser	696	Präpariersauger	1103
Kontraktoren, Rippen-	877	Raspatorien	969
Kopfschwartzangen	731	Skalpellogriff	45
Kornzangen	10, 184-189	Tumorfasszangen	909
KRÄMER , Ligamentum-flavum-Fasszangen	913	LANDON , Scheidenspekula	651
Osteophytenmeißel	998	LANE , Chirurgische Pinzetten	176
Raspatorien	971, 972	Knochenhaltezangen	1020, 1021
Rongeur	909	Knochenheber	933
Wundhaken	407	Magen- und Darm-Zwillingsklemmen	556
KRAUSE , Biopsieaufsatz	705	Organ- und Gewebefasszangen	543
KRAYENBÜHL , Nerv- und Gefäßhäkchen	358	Tuchklemmen	202
KRISTELLER , Scheidenspekula	641-645, 647	Wundhaken	384
KRÖNLEIN , Arterienklemmen	231	LANE TRETOWAN , Knochenheber	933
KRONECKER , Unterbindungsnadeln	329	LANG-STEVENSON , Darmklemmen	554
Kronenspieß	1015	LANGE , Fistelhaken	372
Kropflöffel	453	LANGE-HOHMANN , Knochenheber	934
Krypthaken	579	LANGE-HOHMANN MODIF. , Knochenheber	935
KÜMMEL , Wundhaken	436	LANGENBECK , Amputationsmesser	28, 29
Küretten	989	Amputationssägen	923
Küretten, Abortus-	713	DUROGRIP Nadelhalter	322
Endometrium-, Biopsie-	698	Elevatorien	931
Plazenta-	713	Knochenhaltezangen	1018
Uterus-	708-711	Knorpelmesser	29
Vakuum-	714, 1090	Lappenmesser	28, 917
KÜSTNER , Hakenzangen	681	Raspatorien	971, 972
Kugelelektroden	510, 511, 513	Resektionsmesser	29, 918
		Rippenraspatorien	863
		Wundhaken	394, 395, 398
L		LANGENBECK-GREEN Wundhaken	370
LA GRANGE , Feine Scheren	69	LANGENBECK-MANNERFELTMODIF. , Wundhaken	368
Zahnfleischscheren	69	mit Treangle-Griff	
LABORDE , Trachealdilatatoren	474	Lanzettenelektroden	509
Laborschalen	1108	Lappenmesser	28, 917
Lagerung für Uterus-Dilatatoren	665, 666	LATHBURY-FARRELL , Watteträger	348, 350
LAHEY (SWEET) , Gallengang-Klemmzangen	590	LAWRENCE , Nadelhalter	301
Präparier- und Ligaturklemmen	255	Präparier- und Ligaturklemmen	253
LAHEY , Gallengang-Klemmzangen	590	LAZAR , Mikro-Knüpfpinzetten	140
Hakenzangen	678	LEBSCHÉ , Sternum-Meißel	856
Organ- und Gewebefasszangen	197	Umführungsinstrumente	925
Präparier- und Ligaturklemmen	255	LEECH-WILKINSON Biopsiezangen	704
Wundhaken	404	Uterus-Kanülen	716
		LEES , Atraumatische Bronchusklemmen	812

Alphabetischer Index – Alphabetical Index

M

	Seite		Seite
Markierer, Mamillen-	8	MC KISSOCK , Raspatorien	971
MARQUARDT , Hohlmeißelzangen	1032	MEAD , Hämmer	992
MARTIN , Beckenzirkel	720	Hohlmeißelzangen	1029
Hakenzangen	677	Raspatorien	966
Meniskus- und Knorpelzangen	1043	MEHDORN , Anlegepinzetten für Gefäßclips	210
Scheidenspekula	655	Gefäßclips	210
Uterussonden	670	Mehrzweckklemmen, Atraumatische-	791-793, 809, 810, 823-825, 828, 833, 834
Wundhaken	417	Meißel, Flach-	998-1003, 1006, 1007, 1010
MARTINI , Scharfe Löffel	981	Hohl-	998-1001, 1003, 1007-1011
MASING , DUROGRIP Nadelhalter	307	Hohl-, Spongiosa-	1009
Knorpelritzmesser	32	Osteophyten-	962, 998
Wund- und Venenhaken	373	Spongiosa Hohl-	1010
Maßbänder	7	Sternum-	856
MASSON , DUROGRIP Nadelhalter	318	Wirbelsäulen-	1009
Nadelhalter	303	Meniskushaken	399, 400, 1045
MASSON-LUETHY , Nadelhalter	303	Meniskussmesser	1044
Mastdarm-Rektum-Spekula	570, 571	Meniskuszangen	1043
MATHIEU , DUROGRIP Nadelhalter	325	Mercedes Sperrer	874
Fremdkörperzangen	626	Messbecher	1108
Mastdarm-Rektum-Spekula	571	Messer, Amputations-	28, 29, 917, 918
Nadelhalter	305	Beinhaut-	29, 918
Scheidenspekula	649	Faden-	43
Wundhaken	385	Fistel-	30
MATHIEU-STILLE , Nadelhalter	305	Gips-	1082
MAYFIELD , Hohlmeißelzangen	1032	Knorpel-	29, 918
MAYO , DUROTIP Präparierscheren	94, 101	Knorpelritz-	32
Gallengangsonden	598	Konisation-	696
Präparierscheren	82, 83, 86	Lappen-	28, 917
Sterilisierklammern	207	Meniskus-	1044
SuperCut Scheren	91	Phalangen-	29, 918
Uterussonden	670	Plastik-	32
MAYO-ADAMS , Wundspreizer	465	Resektions-	29, 918
MAYO-HARRINGTON , Präparierscheren	84	Tonsillen-	31
MAYO-HEGAR , Nadelhalter	301, 302	Trigeminus-	31
MAYO-LEXER , DUROTIP Präparierscheren	95, 101	Zwischenknochen-	918
NOIR Präparierscheren	105	Messerelektroden	509, 511
NOIR Präparierscheren mit Wellenschliff	107	Messschieber	8
Präparierscheren	85	Metallgefäß für Markierungsflüssigkeit	8, 25
MAYO-NOBLE , Muskelscheren	84	METZENBAUM , DUROTIP Präparierscheren	97, 98, 102, 103
Präparierscheren	84	Feine Präparierscheren	62
MAYO-ROBSON , Atraumatische Darmklemmen	555	NOIR Präparierscheren	105
Darmklemmen	555	NOIR Präparierscheren mit Wellenschliff	107
MAYO-STILLE , Präparierscheren	82, 83	Präparierscheren	87
MC CLINTOCK , Plazentar- und Abortuszangen	735	SuperCut Scheren	91
MC CLURE , Mikro-Federscheren	48	MEYER , Repositionszangen	1015
MC GIVNEY , Hämorrhoidal-Fasszangen	585	MEYERDING , Wundhaken	371, 416
MC INDOE , Feine anatomische Pinzetten	154	MICHEL , Kehlkopfspiegel	5
Feine chirurgische Pinzetten	172	Klammeranlegepinzetten	352
Hauthäkchen	361	Klammerentfernungszangen	352
Knochensplitterzangen	1040	Rhinoskopiespiegel	5
Monopolare Pinzetten	517	Wundklammern	352
MC KENTY , Raspatorien	960	MICHEL MODIF. , Klammeranlege- und Klammerentfernungszangen	352
MC KENZIE , Trepanationsbohrer	1052, 1053		
Trepanationsfräser	1053		



Alphabetischer Index – Alphabetical Index

M – N

A – Z

	Seite		Seite
MICRO-ADSON , Feine anatomische Pinzetten	151, 152	MOYNIHAN , Gallengang-Klemmzangen	592
Feine chirurgische Pinzetten	168, 169	Gallengangsonden	598
Präparier- und Ligaturklemmen	244	MÜHLING , Knochenschere	116
MICRO-ADSON-BIEMER , Feine chirurgische Pinzetten	168	Raspatorien	969
MICRO-HALSTED , Arterienklemmen	220	MÜLLER , Atraumatische Gefäßclips	214, 215, 784, 785
MIDDELDORPF , Wundhaken	406	Atraumatische Rektum-Anastomosenklemmen	566
Mikro-Fadenschere	60, 768	DUROGRIP Nadelhalter	317, 568
Mikro-Federschere	48-53, 55-60, 747, 749, 768	DUROGRIP Nahtpinzetten	178
Mikro-Knüpfpinzetten	139, 140, 143	Fadenklemmen	213
Mikro-Nadelhalter	282-285, 770-772	Gefäßclips	213
Mikro-Nadelhalter, DIADUST	289, 291, 293, 295-297, 759, 761, 763, 765-767, 769	Hauthäkchen	361
DUROGRIP	286, 287, 773, 774	Mikro-Federschere	55
Mikro-Pinzetten	141, 142, 145, 147, 150, 769	Mikro-Nadelhalter	285
Mikro-Pinzetten, DIADUST	753, 755, 757, 769	Mikro-Pinzetten	141, 142
Mikro-Präparierschere	53	Rektumschere	127, 567
Mikro-Skalpelle	24	Wundhaken	442
Mikro-Skalpellgriffe	44, 45	Mundsperrer	14, 15
Mikro-Venenschere	51	MURPHY , Stirnband	2
Mikrochirurgische Klappen	45	Wundhaken	391
MIKULICZ , Peritoneumklemmen	257-259	MURPHY-LANE , Luxationshebel	945
Tonsillenklemmen	240	MUSEUX , Hakenzangen	678, 683, 684
Wundhaken	437, 438	Organ- und Gewebefasszangen	197
MILLER , Knochenraspeln	979	Muskelschere	84
MILLES , Mikro-Federschere	52	Myomheber	690
MILLIN , Atraumatische Kapselasszangen	622	Myrtenblattsonden	344
Blasenhalsspreizer	622		
Blasewundspreizer	496, 617		
Fadenhaltezzangen	326, 622		
MILLS , Gallengangschere	597	N	
MIOS, Hüftretractoren	947-959	NABATOFF , Venenstripper	887
MITCHELL , Raspatorien	973	Nabelschnurdilatator	724
MIXTER , Präparier- und Ligaturklemmen	841	Nabelschnurklemmen	724
Gallenkanal- und Cystikusklappen	593	Nabelschnurschere	123, 723
Präparier- und Ligaturklemmen	253, 255, 841	Nadel, Schleimhaut-Resektion-	515
MIXTER-O'SHAUGNESSY , Präparier- und Ligaturklemmen	249	Nadeldosen	279
MOD. BERLIN , Endometrium-Biopsieküretten	698	Nadelelektroden	509-513
MOD. MÜNCHEN , Endometrium-Biopsieküretten	698	Nadelhalter	299-303, 305
MOD. USA , Gipsspreizer	1087	Nadelhalter, Bumerang-	326, 623
Modularer Handgriff	959	DIADUST	289, 291, 293, 295-298, 759, 761, 763, 765-767, 769
MOLLISON , Wundspreizer	464	DUROGRIP	286, 287, 307-310, 312-325, 568, 773-779
MOLT , Raspatorien	966	Mikro-	282-287, 289, 291, 293, 295-297, 759, 761, 763, 765-767, 769-774
Monopolare Anschlusskabel	506, 513, 522	mit Schere	304
Monopolare Elektroden	509-511	mit Schere, DUROGRIP	311
Monopolare Handgriffe	506, 508, 513	Nadeln	328
Monopolare Klappen	520	Nadeln, Chirurgische, Näh-	276-278
Monopolare Pinzetten	516-519	Drahtumführungs-	1066
Monopolare Schere	515	Führungs-	353
MORRIS , Atraumatische Aortaklappen	811	Unterbindungs-	329-336, 1056
Atraumatische Rektum-Anastomosenklappen	563	Nägel	1063
Wundhaken	415	NÄGELE , Geburtszangen	726
MORSE , Sternensperrer	872	Nähnadeln, Chirurgische-	276-278
MOYNIHAN , Arterienklemmen	223, 239		
Darmklappen	553		

Alphabetischer Index – Alphabetical Index

N – P

A-Z

	Seite		Seite
Nagelausreißzangen	1079	O	
Nagelfeilen	13	O'SHAUGNESSY , Präparier- und Ligaturklemmen	249, 252
Nagelhautscheren	12, 64	OBWEGESER Ahlen	1056
Nagelscheren	11, 13, 130	Osteotome	1005
Nagelspaltscheren	75, 1079	Wundhaken	401, 402
Nagelspaltzangen	1079	OCHSNER , Atraumatische Aortaklemmen	817
Nagelzangen	12	Fadenpinzette	158
Nahtpinzetten, DUROGRIP	163, 178	Gallengangsonden	599
Nasenflügelretraktor	363, 370	Öl, Instrumenten-	1112
Nasenflügelscheren	77	Ösenrinnensonden	343
Nasenpinzetten	165-167	OFFICER , Chirurgische Pinzetten	176
Nasenplastikscheren	77	Offset-Scheren	111
Nasensonden	347	Ohrhäkchen, stumpf	356
Nasentamponzangen	184	OLDBERG , Rongeur	908
NAUNTON MORGAN , DUROGRIP Nadelhalter	317	OLIVECRONA , Drahtsägen	924
Rektum-Spekula mit Kaltlicht	574	Hohlmeißelzangen	1030
NEGUS , Saugdissektoren	1103	Trigeminusmesser	31
Tonsillenklemmen	240	OLLIER , Wundhaken	394
NELATON , Hohlsonden	342	OMBREDANNE , Hämmer	996
NELSON , Lungenfasspinzetten	180, 838	Organfasszangen	190, 192, 193, 197-199, 540, 543
NELSON-METZENBAUM DUROTIP Präparierscheren	97, 102, 103	Organfasszangen, Atraumatische-	191, 544, 545, 835-837
Präparierscheren	88	ORMROD-SCHMITT , Ligaturplättchen	1065
NELSON-METZENBAUM (MC INDOE) ,	98	Osteophytenmeißel	962, 998
DUROTIP Präparierscheren		Osteotome	998, 999, 1001-1008, 1010
Nerv-Approximator	212	Osteotome, Fischschwanz-	1001
Nerv-Präparierscheren	63, 79	Ovarienzangen	685-688
Nervhäkchen	356-359	Ovarienzangen, Atraumatische-	687
Nervwurzelhaken	376	OVERHOLT , Präparier- und Ligaturklemmen	247
Netzgerät	3	OVERHOLT-GEISSENDOERFER Präparier-	246
NIEDERDELLMANN Osteotome	1005	und Ligaturklemmen	
Nierenfasszangen	613	OVERHOLT-MIXTER Präparier- und Ligaturklemmen	246
Nierenklemmen	608-610	O'CONNELL , Dissektoren	929
Nierenklemmen, Atraumatische-	608, 796	O'SULLIVAN-O'CONNOR Bauchdeckenhalter	489
Nierenschalen	1108		
Nierensteinzangen	614-616	P	
Nierenstielklemmen	611, 612	Pankreasklemmen, Atraumatische-	796
Nierenstielklemmen, Atraumatische-	612	Parametriumklemmen	270, 271, 692, 693
NISSEN , Arterienklemmen	225	Parametriumklemmen, Atraumatische-	100, 268, 269
Gallenkanal- und Cystusklemmen	591	Parametriumscheren	120, 121, 692, 693
Präparier- und Ligaturklemmen	245, 256	PARKER , Wundhaken	379, 380
NOIR , Präparierscheren	105	PARKER-KERR , Anastomoseklemmen	560
Präparierscheren mit Wellenschliff	106, 107	PARRY-COOLEY , Atraumatische Anastomosenklemmen	830
NORFOLK and NORWICH , Laminektomie-Wundspreizer	468	PARTSCH , Flachmeißel	1000
NORTHBENT , Ligaturscheren	128	Hohlmeißel	1000
NORTHFIELD , Hohlmeißelzangen	1031	Raspatorien	960
NOTO , Organ- und Gewebefasszangen	193	PARTSCH MOD. LANGE , Raspatorien	960
Polypen- und Ovarienzangen	686	PASSOW , Stößel	997
Tupfer- und Schwammzangen	193	Patellazangen	1016
NOVAK-SCHOECKAERT , Endometrium-Biopsieküretten	698	Patent-Ductusklemmen, Atraumatische-	805, 806, 826, 827
NOYES , Mikro-Federscheren	48	PAUL , Sehnenscheidenhaken	373
NUSSBAUM , Darmklemmen	553	PAYR , Darm- und Magenquetschklemmen	558
		Führungs-Hohlsonden	337



Alphabetischer Index – Alphabetical Index

P

	Seite		Seite
PEAN , Arterienklemmen	231, 232, 234, 239	Pinzetten, Mikro-	139-143, 145, 147, 149, 753, 755, 757, 769
Atraumatische Gefäßklemmen	795	Monopolare-	516-519
Nierenklemmen	609	Naht-	163, 178
Schlauchklemmen	17	Nasen-	165-167
PEDERSON , Scheidenspekula	640	Splitter-	181
PEET , Splitterzangen	181	Tumor-	179
PELKMANN , Fremdkörperzangen	200	Wundrand-	170
Gallensteinzangen	604	PIPER , Geburtszangen	727
Tamponzangen	672	PITHA , Fremdkörperzangen	200, 626
Pelvishaken	440, 441, 578	Plättchen, Ligatur-	1065
PENFIELD , Dissektoren	928, 929	Plastikmesser	32
Penisklemmen	625	Plastikscheren	70
PENNINGTON , Arterienklemmen	241	Plattenelektroden	510
Darmfasszangen	542	Plazentarküretten	713
PENNYBACKER , Dissektoren	929	Plazentarlöffel	712
Hohlmeißelzangen	1031	Plazentarzangen	732-735
Raspatorien	972	PLESTER , Saugkanülen	1095
Rongeur	903	Wundspreizer	462
PERCY , Amputationsretraktoren	920	POIRIER , Gewebefasszangen	196
Perinealsperrer	577	Polypenzangen	685-688
Peripheralklemmen, Atraumatische-	805-807	Polypenzangen, Atraumatische-	687
Peritoneumklemmen	257-260	POOL , Saugkanülen	1093
PERKINS , Wundspreizer	463	Poplitea-Sperrer	497
PERTHES , Reibahle	1055	POTTS , Präparierscheren	80
PERWITZSCHKY , Speichelgangschere	68	POTTS-DE MARTEL , Gallengangscheren	597
Phalangenmesser	29, 918	Gefäßscheren	110, 111
PHANEUF , Hysterektomieklammern	260	POTTS-DIETHRICH , Gefäßscheren	108, 109, 751
Phlebextraktoren	889	POTTS-SMITH , Gefäßscheren	111, 114
Phlebdissektoren	889	POZZI , Hakenzangen	674, 676
PICCOLO , Watteträger	348	Präparationshäkchen	376
Pinzetten, Anatomische, Feine-	151-155, 783	Präparierklemmen	244-256, 619, 840, 841
Anatomische-	156-158	Präparierklemmen, Atraumatische-	797, 798
Atraumatische-	160-162, 567, 782, 783	Präpariersauger	1103
Atraumatische-, Ultra-Light	159, 546, 781	Präparierscheren	76-89, 113, 618
Augen-	168	Präparierscheren, Bipolare-	530
Bajonettförmige-	165, 166	DUROTIP	94-99, 101-103
Bipolare-	523-529, 620	Feine-	62, 63, 76, 78, 80, 81
Chirurgische-	168, 170, 173-179	Mikro-	53
Clipanlage-	210, 211	Nerv-	63
Darm-	180, 543	NOIR-	105-107
DIADUST	145, 147, 149, 150, 753, 755, 757, 769	PRATT , Hakenzangen	680
DUROGRIP	162-164, 178, 543	Mastdarm-Rektum-Spekula	571
Faden-	158	Organ- und Gewebefasszangen	198
Feine chirurgische-	168, 169, 171, 172	Uterus-Dilatatoren	663
Fixier-	165	PRICE THOMAS , Bronchusklemmen	845
Gefäß-	179	Profundaklemmen, Atraumatische-	798
Gewebefass-	179, 180, 543	Proktoskope	573, 575
Hornhaut-	151	Prostatatrektor	452, 620
Klammeranlage-	352	PROVIDENCE-HOSPITAL , Arterienklemmen	221
Kniegebogene-	167	Pudendusnadeln	721
Knüpf-	139, 140, 143	Punktionskanülen, Sternum-	855
Lungenfass-	180, 838	PUTTI , Knochenfeilen	980
		Pylorusspreizer	557

A-Z

Alphabetischer Index – Alphabetical Index

Q – S

A – Z

	Seite		Seite
Q			
QUERVAIN , Elevatorien	931	RIBBON , Bauch- und Darmspatel	450
QUINBY , Feine Scheren	67	RICARD , Bauchdeckenhalter	483
Zahnfleischscheren	67	RICHARDSON , Wundhaken	413, 414
		RICHARDSON-EASTMAN , Wundhaken	413
		RICHS , Monopolare Klemmen	520
		Rippenfasszangen	859
		Rippenkontraktoren	877
		Rippenraspatorien	861-863
		Rippenscheren	857, 858
		Rippensperrer	866-871, 877
R		RNTNE HOSPITAL , Wundspreizer	463
R.N.O.H. , Biopsie-Instrumente für Knochen	1057	ROBERTS , Arterienklemmen	238
Rabenschnabel	1087	Raspatorien	966
RAGNELL , Feine Präparierscheren	63	ROBIN , Tuchklemmen	204
Wundhaken	379	ROCHARD , Bauchdeckenhalter	448
RAMPLEY , Tupper- und Schwammzangen	190	Befestigungsgestell für Bauchdeckenhalter	449
RAMSEY , Anatomische Pinzetten	158	Fixiervorrichtung für Bauchdeckenhalter	448
Chirurgische Pinzetten	177	ROCHESTER-CARMALT , Arterienklemmen	237
RANDALL , Endometrium-Biopsieküretten	698	ROCHESTER-OCHSNER , Arterienklemmen	235
Nierensteinzangen	614-616	ROCHESTER-PEAN , Arterienklemmen	233
RANKIN , Arterienklemmen	224	ROEDER , Tuchklemmen	203
Rasierklingsmesser	9	Röntgen-Messstäbe	7
Raspatorien	960-977	RÖTTGEN-RUSKIN , Hohlmeißelzangen	1032
Raspatorien, Rippen-	861-863	ROLLET , Hauthäkchen	360
Saug-	1103	Rongeurs	899-912
Raspeln, Knochen-	978-980	ROSE , Wundhaken	379
RECAMIER , Plazentar- und Abortusküretten	713	ROSER-KÖNIG , Mundsperrer	15
Uterusküretten	708	ROTUNDA , Uterusspül-Katheter	717
REDON -Führungsadeln	353	ROUX , Wundhaken	381-383
Reflektor	2	ROWBOTHAM , Saugkanülen	1101
Reflexspiegel	2	RUMEL , Präparier- und Ligaturklemmen	251
Reibahlen	1055	RUMEL-BELMONT , Tourniquets	851
REILL , Drahtschneidezangen	1076	RUSKIN , Hohlmeißelzangen	1032
Mikro-Nadelhalter	284, 772	RUSKIN-LISTON , Knochensplitterzangen	1040
Repositionszangen	1015	RUSS. MODELL , Chirurgische Pinzetten	179
Sehnenstripper	1046	RUST , Amputationssägen	921
REIN/KUPKA , DUROGRIP Nadelhalter	321, 775	RYDEL-SEIFFER , Stimmgabel	6
Rektum-Anastomosenklemmen	561, 562	RYDER , DIADUST Nadelhalter	298, 767
Rektum-Anastomosenklemmen, Atraumatische-	563, 564, 566	DUROGRIP Nadelhalter	319, 320, 778, 779
Rektum-Spekula	573		
Rektum-Spekula, Kaltlicht	574	S	
Rektumbiopsiezangen	580-582	Sägeblätter	921, 922
Rektumscheren	125-127, 565, 567	Sägen, Amputations-	921-923
REMYNTON-HOBB , Monopolare Pinzetten	518	Draht-	924
Repositionsstößel	1015	Fingerring-	1079
Repositionszangen	1014-1016	Gips-	1082
RESANO , Atraumatische Rektum-Anastomosenklemmen	564	SAENGER , Plazentar- und Abortuszangen	733
Kapselscheren	89	Salpingograph	715
Resektionsmesser	29, 918	Samenstrang Fixierklemmen	625
Retraktoren, Amputations-	920	Samenstranghaken	625
Hüft-	947-959	SAROT , Arterienklemmen	229, 238
MIOS-	947-959	DUROGRIP, Nadelhalter	309
REVERDIN , Bauch- und Darmspatel	450		
Nadeln	328		
REYNOLDS , Präparierscheren	80		
REYNOLDS-JAMESON , Gefäßscheren	63		
Rhinoskopie Spiegel	5		



Alphabetischer Index – Alphabetical Index

S

A-Z

	Seite		Seite
SATINSKY , Anastomosenklemmen	843	SENN-MILLER Wundhaken	377
Atraumatische Bulldogklemmen	821	Sequesterzangen	1017
Gefäßscheren	115	SEUTIN , Gipspscheren	134, 1084
Sattelhaken	369	SEWALL , Elevatorien	963
SATTERLEE , Amputationssägen	923	SEYFFERT , Scheidenspekula	639
SAUER , Lidsperrer	458	Siebbeinzangen	899-901
SAUERBRUCH , Abfallzange	18	SIEBOLD , Uterusscheren	119
Rippenscheren	857	Sigmoidoskope	575
Wundhaken	404, 425	SILVER , Handdermatom	35
SAUERBRUCH-CORYLLOS Hohlmeißelzangen	860, 1037	SIMON , Fistelhaken	372
Saugdissektoren	1103	Fistelmesser	30
Saugdissektoren, Tonsillen-	1103	Scharfe Löffel	988
Sauger, Präparier-	1103	Scheidenspekula	655
Saugglocken	725	Uteruslöffel	707
Sauggriffe	1092	Wundhaken	417
Sauginstrumente	1098	SIMPSON , Geburtszangen	728
Saugkanülen	885, 886, 1091-1102, 1104, 1105	Uterussonden	671
Saugraspatorien	1103	SIMPSON-BRAUN , Geburtszangen	727
Saugschlauch	714, 1090	SIMS , DUROTIP Uterusscheren	103
SAUNDERS , I.U.D.-Entfernungshaken	697	Gynäkologische Scheren	117, 118
Scapula-Haken	426, 880	Mastdarm-Rektum-Spekula	570, 571
SCOVILLE-HAVERFIELD Laminektomie-Wundspreizer	476	Scheidenspekula	640
SCOVILLE-RICHTER Wund- und Laminektomiespreizer	477	Uterusküretten	709
SCUDDER , Atraumatische Magenklammern	557	Uterusscheren	99, 117, 118
SEBILEAU , Elevatorien	931	Uterussonden	670
SEDILLOT , Raspatorien	971, 973	SIMS-MAIER , Korn- und Tupferzangen	188
SEGOND , Hysterektomieklammern	265	SIMS-SIEBOLD , Uterusscheren	120
SEGOND-LANDAU , Hysterektomieklammern	264	Sinus-Knopfsonden	345
Sehnen-Doppelhaken	369	Sinusklemmen	184
Sehnendurchziehsonden	1048	Skalpelle	26, 27
Sehnenfasszangen	194, 195	Skalpelle, Mikro-	24
Sehnenscheidenhaken	373	Skalpelle, Einmal-	22-24
Sehnenscheren	78	Steril-	22-24
Sehnenstripper	1046, 1047	Skalpellgriffe	38-41, 618
SEIDEL , Scheidenspekula	641	Skalpellgriffe, Mikro-	44, 45
SEIDL , Biopsiezangen	702	Skalpelloklingen	42, 43
SEIFFERT , Sonden	347	SMILLIE , Meniskusmesser	1044
Seitenschneider	1075, 1076	Wund- und Meniskushaken	399, 1045
Sekretlöffel	626	SMITH , Verbandsscheren	131
Sekretlöffel, Uterus-	697	SMITH-BUIE , Analspreizer	573
SELDIN , Raspatorien	966	SMITH-PETERSEN , Osteomose	1004
SELLHEIM , Geburtslöffel	730	SOMER , Uterusfasszangen	689
SELLORS , Rippenspreizer und -kontraktor	877	Sonden	347
SELMAN , Chirurgische Pinzetten	179	Sonden, Anal-	342, 343, 579
SEMB , Hohlmeißelzangen	860, 1036	Doppelknopf-	346
Knochenhalteclangen	1018	Fistel-	343, 579
Präparier- und Ligaturklammern	840	Gallengang-	598, 599
Raspatorien	975	Hohl-	342, 347, 929
Rippenfasszangen	859	Knopf-	345, 346
Rippenraspatorien	862	Myrtenblatt-	344
SEMKEN , Feine anatomische Pinzetten	154	Nasen-	347
Feine chirurgische Pinzetten	171	Ösenrinnen-	343
SEMM , Bauchdeckenhalter	491	Ohr-	347
Scheidenspekula	639	Sehnenclzieh-	1048

Alphabetischer Index – Alphabetical Index

S – SCH

A-Z

	Seite		Seite
Sonden, Speichelgang-	347	SPURLING , Rongeure	902, 906, 907
Uterus-	670, 671	SUBRAMANIAN (MODIF.) , Atraumatische Aortaklemmen	816
SPACKMAN , Uterus-Kanülen	716	SuperCut Scheren	90, 91
Spatel	369	SWEDISH , Dissektoren	929
Spatel, Bauch-	435, 436, 450, 451	SYME , Raspatorien	966
Blasen-	496, 617	Unterbindungsnadeln	334
Darm-	435, 436, 450, 451	Synovektomie-Zangen	1026
Gefäß-	849, 850	SYPERT , Hohlmeißelzangen	1035
Lungen-	422-425, 878, 879, 881	Rongeure	912
Zungen-	4, 348	Stanzen	895
Speichelgangscheren	68	SYSTRUNK , Nagelspaltscheren	75, 1079
Speichelgangsonden	347		
Spekula, Endo-	667		
Mastdarm-Rektum-	570, 571	SCH	
Rektum-	573	SCHAEDEL , Tuchklemmen	201
Rektum-, Kaltlicht	574	Schalen, Labor-	1108
Scheiden-	636-658	Nieren-	1108
SPENCER , Ligaturscheren	128	Scharfe Löffel	981-989
SPENCER-WELLS , Arterienklemmen	232	SCHEDE , Scharfe Löffel	984
Sperrer, Iliaca-	475	Scheidenspekula	636-658
Lid-	458	SCHERBACK , Scheidenspekula	657
Mammaria-	876	Scheren, Anatomie-	68
Mund-	14, 15	Arteriotomie-	80
Perineal-	577	Augen-	49
Poplitea-	497	Bauchdecken-	122
Rippen-	866-871, 877	Bipolare-	530
Sternum-	872, 873, 876	Blech-	129, 1072, 1073
Thorax-	864, 865, 874	Blech-, DuroTIP	1072
Sphinkterskope	572	Bulldog-	76
Spiegel, Kehlkopf-	5	Chirurgische-	71-75, 82, 93, 101, 122
Reflex-	2	Damm-	124, 724
Rhinoskopie-	5	Darm-	125, 127
Stirn-	2	Draht-	100, 129, 1072, 1073
Spiralbohrer	1054	Draht-, DuroTIP	1072
Splitterpinzetten	181	Dura-	112
Splitterzangen	181	DuroTIP	92-100, 103
Spongiosa-Hohlmeißel	1009	DuroTIP mit Wellenschliff	101-104
Spreizer, Anal-	573, 576	E nukleation-	77
Blasenwund-	496	Faden-	60, 92, 101, 768
Gips-	1087	Feine-	12, 61, 63-70, 92
Haut-	473	Gallenblasen-	596
Hemilaminektomie-	469	Gallengang-	597
Laminektomie-	477	Gefäß-	63, 78, 100, 108-115, 751
Laminektomie-Wund-	468-471, 476, 478	Gips-	134, 135, 1083-1086
Pylorus-	557	Gynäkologie-	117-121
Struma-	472	Hysterektomie-	100
Thyreoid-	472	Inzisions-	75
Vulva-	472, 473, 659	Iris-	61, 64
Wirbelkörper-	481	Kapsel-	89
Wirbelsäulen-	479, 480	Kleider-	132-135, 1082
Wund-	456-467, 472, 477	Knochen-	116
Sprenger, Blasen-	722	Knorpel-	81
Spritzen, Hämorrhoidal-	587	Ligatur-	104, 128
Spülkanülen	598, 886, 1104		



Alphabetischer Index – Alphabetical Index

SCH - ST

A-Z

	Seite		Seite
Scheren, Mikro-	48-53, 55-60, 747, 749, 768	SCHUHKNECHT , Saugkanülen	1097
mit Wellenschliff	106, 107	SCHULZE , Salpingograph	715
Monopolare-	515	SCHUMACHER MOD. WAGNER , Knochenheber	943
Muskel-	84	SCHUMACHER , Biopsieaufsatz	705
Nabelschnur-	123, 723	Biopsiezangen	701
Nagel-	11, 13, 130	Knochenheber	944
Nagelhaut-	12, 64	Nabelschnurscheren	123, 723
Nagelspalt-	75, 1079	Sternum-Scheren	855
Nasenflügel-	77	Schwammzangen	190, 192, 193
Nasenplastik-	77	SCHWEDISCHES MODELL , Anatomische Pinzetten	157
Nerv-Präparier-	63, 79	Schwesternscheren	132
NOIR-	105-107		
Offset-	111	ST	
Parametrium-	120, 121, 692, 693	ST. BARTS , Nerv- und Gefäßhäkchen	356
Plastik-	70	Rongeurs	900, 901
Präparier-	53, 76-89, 94-99, 101-103, 106, 107, 113, 618	ST. MARKS , Pelvishaken	440, 441, 578
Präparier-, Feine-	62, 63, 76, 78, 80, 81	ST. MARKS MODIF. GIRONA , Perinealsperrerr	577
Präparier-, NOIR	105	ST. MARTIN , Chirurgische Pinzetten	168
Rektum-	125-127, 565, 567	STACKE , Sonden	347
Rippen-	857, 858	STAMM , Knochensplitterzangen	1038
Schwestern-	132	Stanzen, Aorten-	852
Sehnen-	78	Haut-	33
Speichelgang-	68	Knochen-	892-898
Sternum-	855, 856	Staubinden	916
Strabismus-	62, 76	STEINMANN , Nägel	1063
SuperCut-	90, 91	STELLBRINK , Synovektomie-Zangen	1026
Uterus-	99, 103, 117-120	STELZNER , Rektumscheren	126, 565
Venen-	51	Sterilisierklammern	207
Verband-	131-133, 1082	Sterilisierrahmen	33, 919
Wundrand-	72	Sterilisierzangen	1109
Zahnfleisch-	12, 64-67, 69, 70, 92	STERILIT , Instrumenten-Öl	1112
Scherköpfe, Elektra II	9	Sterilskalpelle	22-24
Schieber, Mess-	8	STERNBERG , Wundhaken	378
SCHINK , Handdermatom	34	Sternummeißel	856
Schlauchklemmen	17, 18	Sternumpunktionskanülen	634, 855
Schleimhaut-Resektionsnadel	515	Sternumscheren	855, 856
Schließzangen	559	Sternumsperrerr	872, 873, 876
Schlingenelektroden	509, 513	STEVENS , Feine Präparierscheren	62, 78
SCHMELZ , Gestationskalkulator	720	Gefäß- und Sehnnenscheren	78
SCHMID , Gefäß-Spülkanülen	846	STIEGLITZ , Splitterzangen	181
Gefäßspatel	850	STILLE , Flachmeißel	1003
Mundsperrerr	14	Gipsscheren	1086
SCHMIEDEN , Führungs-Hohlsonden	337	Hohlmeißel	1003
SCHMIEDEN-TAYLOR , Durascheren	112	Hohlmeißelzangen	1034
SCHNEIDER-SAUERBRUCH , Raspatorien	973	Nierenklemmen	610
SCHNIDT , Arterienklemmen	240	Osteotome	1003
Tonsillenklemmen	240	Präparierscheren	85
SCHOEMAKER , Colectomie-Klemmen	554	STILLE-AESCLAP , Gipsscheren	1085
SCHOENBORN , Wund- und Venenhaken	375	STILLE-BARRAYA , Gefäß- und Tumorpinzetten	179
SCHRÖDER , Hakenzangen	675, 676, 678, 679	Gewebebspinzetten	543
Organ- und Gewebefasszangen	197, 199	STILLE-RUSKIN , Hohlmeißelzangen	1034
Uteruslöffel	707		
SCHUBERT , Biopsiezangen	699		

Alphabetischer Index – Alphabetical Index

ST – U

A-Z

	Seite		Seite
Stimmgabeln	6	Trachealhäkchen	364-366, 375
Stirnbänder	2	Transformator	3
Stirnlampen	3	TRAVERS , Wundspreizer	467
Stirnlampen, Zubehör	3	TRELAT , Raspatorien	961
Stirnspiegel	2	Scheidenspekula	638
STOCKMANN , Penisklemmen	625	Trepanationsbohrer	1052, 1053
Stößel	997	Trepanationsfräser	1052, 1053
Stößel, Repositions-	1015	TREVES , Chirurgische Pinzetten	177
Strabismusscheren	62, 76	Trigeminusmesser	31
STRANDELL-STILLE , Sehnenscheidenhaken	373	TROELTSCH , Pinzetten, kniegebogen	167
STRASSBURGER MODELL , Chirurgische Pinzetten	178	Trokare	634
STRATTE , DUROGRIP, Nadelhalter	315	Trokare, Universal-	634
STRAUSS , Penisklemmen	625	TROTTER , Hohlmeißelzangen	1030
Stripper, Endarterektomie-	851	TROUSSEAU , Trachealdilatatoren	474
Nerv-	1046	Tuchklemmen	201-206
Sehnen-	1046, 1047	TUDOR-EDWARDS , Wundhaken	443
Venen-	887, 888	TÜBINGER MODELL , Gallensteinzangen	605
STRUCK , Thoraxsperrer	865	Scheidenspekula	655
STRULLY , Gefäßscheren	112, 113	Wundhaken	417
Strumaspreizer	472	TUFFIER , Arterienfasszangen	196
		Bauch- und Darmspatel	450
		Darm- und Gewebefasszangen	538
		Rippensperrer	866, 867
		Wundhaken	443
		Tumorfasszangen	909
		Tumorphinzetten	179
		Tunnelierungsinstrumente	853
		Tupferzangen	10, 184-190, 192, 193
		TURNER , Monopolare Pinzetten	517
		TURNER-WARWICK , Bauchdeckenhalter	492, 493
		Harnröhrenbougies	629
		TUTTLE , Lungenfasspinzetten	180, 838
T		U	
TÄGER , Knochenhebel	944	UCHIDA MODIF. BURKE , Ureterlöffel	691
TAKAHASHI , Rongeurs	901	UFFENORDE , Scharfe Löffel	983
Tamponhalter	582	ULRICH , Fistelmesser	30
Tamponzangen	672, 673	ULRICH-AESCLAP , Korn-, Tupfer- und Waschzangen	186
TARNIER , Geburtszangen	729	Ultra-Light-Pinzetten, ATRAUMATA	159, 781
TAYLOR , Retraktor	946	Umführungsinstrumente	925
TEALE , Hakenzangen	681, 682	Universaltrokare	634
Tenotome	27	Unterbindungsnadeln	329-336, 1056
THOMS-GAYLOR , Biopsiezangen	699	Ureter-Tunnelier-Klemmen	691
Thoraxsperrer	864, 865, 874	Ureterlöffel	691
THOREK , Gefäßscheren	114	Ureterzangen	624
THORPE , Hornhautpinzetten	151	Urethraretraktor	452, 620
Thyreoid-Spreizer	472	US-ARMY , Wundhaken	386
TISCHLER , Biopsiezangen	706	Uterus-Depressor	671
Titanligaturclip	738, 740, 742, 744	Uterus-Dilatatoren	662-664
TÖNNIS , Durahäkchen	360	Uterus-Dilatatoren, Lagerung	665, 666
DUROGRIP Nadelhalter	322	Uterus-Kanülen	716, 717
Feine Präparierscheren	81	Uterus-Klemmzangen	730, 731
Gefäßspatel	850		
Hohlsonden	929		
Nadelhalter	305		
TÖNNIS MODIF. , DUROGRIP Nadelhalter	322		
TÖNNIS-ADSON , DUROTIP Präparierscheren	96, 102		
Feine Präparierscheren	80		
Tonnenzangen	1070		
Tonsillen-Saugdissektoren	1103		
Tonsillenklemmen	240		
Tonsillennmesser	31		
Tourniquets	851		
Trachealdilatatoren	474		



Alphabetischer Index – Alphabetical Index

U – W

A – Z

	Seite		Seite
Uterus-Sekretlöffel	697	Waschzangen	10, 185, 186
Uterusfasszangen	688, 689	WATSON , Handdermatom	35
Uterusküretten	708-711	WATSON-CHEYNE , Raspatorien	964
Uteruslöffel	707	WATSON-JONES , Knochenheber	934
Uterusscheren	99, 117-120	Watteträger	347-351
Uterusscheren, DUROTIP	103	WAUGH , Feine chirurgische Pinzetten	172
Uterussonden	670, 671	Monopolare Pinzetten	517
Uteruspülkatheter	717	WEBER , Atraumatische Aorta-Anastomosenklemmen	818
		WEBSTER , DUROGRIP Nadelhalter	308
		Nadelhalter	299
		WECKER , Augenscheren	49
		WEIL-BLAKESLEY , Rongeurs	899
		WEISSBARTH , Scheidenspekula	654
		WEITLANER , Wundspreizer	459-461, 466
		WELLER , Meniskus- und Knorpelzangen	1043
		Präparierscheren	89
		WERTHEIM , Atraumatische Anastomosenklemmen	808
		Atraumatische Klemmzangen	272
		Atraumatische Nierenstielklemmen	612
		Atraumatische Parametriumklemmen	100, 268, 269
		DUROGRIP Nadelhalter	315
		DUROTIP Präparierscheren	99
		Gynäkologische Scheren	118
		Hysterektomieklappen	263, 264, 270
		Nierenstielklemmen	611
		Parametriumklemmen	270
		WERTHEIM-CULLEN , Klemmzangen	273
		Nierenstielklemmen	612
		WIENER MODELL , Hysterektomieklappen	262
		WIKSTROEM , Präparier- und Ligaturklemmen	250, 840
		WILDE , Pinzetten, kniegebogen	167
		WILLET , Kopfschwanzzange	731
		WILLIAMS , Lungenfasszangen	838
		Organ- und Gewebefasszangen	543
		WILLIGER , Elevatorien	930
		Raspatorien	961
		Scharfe Löffel	981, 984
		WILSON , Hakenzangen	676
		Organ- und Gewebefasszangen	199
		Tonsillenklemmen	240
		WILSON-HEY , Monopolare Klemme	520
		Winkelklemmen	612
		Winkelklemmen, Atraumatische-	612
		WINKELMANN , Beschneidungsklemmen	631
		WINTER , Plazentar- und Abortuszangen	732
		Wirbelkörperspreizer	481
		Wirbelsäulen-Wundspreizer	476-480
		Wirbelsäulenmeißel	1009
		WITT , Sternum-Punktionskanülen	855
		WÖRRLEIN , Repositionsstößel	1015
		WOLFF , Gipsabreißzangen	1087
		WRIGLEY , Geburtszangen	728
		WULLSTEIN , Saugkanülen	1098-1100
		Wundspreizer	460

V

Vakuum Extraktion, Saugglocken	725
Vakuumküretten	714, 1090
VALLEIX , Uterussonden	671
Valven, Bauchdecken-	482-484
VANNAS , Mikro-Federscheren	48, 50, 52
VARADY , Mini-Venenstripper-Bestecke	888
Phlebextraktoren	889
Phlebdissektoren	889
VARIO, Wundhaken-System	420, 421
Vena-Cava-Klemmen, Atraumatische-	800
Venenhaken	373-376
Venenkomplekklemmen	619
Venenscheren, Mikro-	51
Venenstripper	887, 888
Verbandscheren	131-133, 1082
VERBRUGGE , Knochenhalte-zangen	1023
VERBRUGGE-MÜLLER , Knochenheber	938
VERHOEVEN , Saugkanülen	1099
WISE , Mikro-Knüpfpinzetten	139
VOLKMANN , Knochen- und Wundhaken	387, 388
Scharfe Löffel	981, 984
Wundhaken	389
Vorhautfasszangen	625
Vulva-Spreizer	472, 473, 659

W

WAGENER , Nerv- und Gefäßhäkchen	356
WAGNER , Biegeinstrumente für Kirschnerdrähte	1059
Hämmer	994
Hohlmeißel	1011
Knochenheber	936
Raspatorien	977
Rongeurs	911
WALLICH , Plazentar- und Abortuslöffel	712
WALTER , Hohlmeißel	1003
WALTON , Biopsiezangen für Rektum	581
WANGENSTEIN , DUROGRIP Nadelhalter	316
DUROGRIP Pinzetten	163, 543
Nadelhalter	303
WARD , Raspatorien	961

Alphabetischer Index – Alphabetical Index

W – Z

A – Z

	Seite		Seite
Wundhäkchen	364	Zangen, Gallenblasen-	190, 594-596, 687
Wundhaken	370-411, 413-419, 422, 423, 425-435, 437-439, 442-446, 569, 946, 1045	Gallenstein-	603-605
Wundhaken, CARBOTRAC	412	Geburts-	726-729
Treangle-Griff	367-369	Gewebefass-	190, 193, 196, 197, 199, 538-540, 543
Wundhakenblätter, VARIO	420	Hämorrhoiden-	585
Wundklammern	352	Haken-	674-684
Wundrandpinzetten	170	Hohlmeißel-	860, 1026-1037
Wundrandscheren	72	Kathetereinführungs-	15
Wundspreizer	456-467, 472, 477	Klammeranlege-	352
Wundspreizer, Blasen-	496, 617	Klammerentfernungs-	352
Femur-	473	Knochenhalte-	1016-1024
Wirbelsäule	476, 477	Knochenhalte-, selbstzentrierend	1023
Wirbelsäulen-	478-480	Knochensplitter-	859, 1038-1042
		Knöchelfass-	1016
		Knorpel-	1043
		Kopfschwarten-	731
		Korn-	10, 184-189
		Kreuzbanddurchzieh-	195
		Lungenfass-	838, 839
		Meniskus-	1043
		Nagel-	12
		Nagelausreiß-	1079
		Nagelspalt-	1079
		Nierenfass-	613
		Nierenstein-	614-616
		Organfass-	190, 192, 193, 197-199, 540, 543
		Ovarien-	685-688
		Patella-	1016
		Plazentar-	732-735
		Polypen-	686-688
		Rektumbiopsie-	580-582
		Repositions-	1014-1016
		Rippenfass-	859
		Schließ-	559
		Schwamm-	190, 192, 193
		Sehnendurchzieh-	195
		Sehnenfass-	194
		Sehnenführungs-	195
		Sequester-	1017
		Siebbein-	899-901
		Splitter-	181
		Sterilisier-	1109
		Synovektomie-	1026
		Tampon-	672, 673
		Tonnen-	1070
		Tumorfass-	909
		Tupfer-	10, 184-190, 192, 193
		Ureter-	624
		Uterusfass-	688, 689
		Vorhautfass-	625
		Wasch-	10, 185, 186
		Zungen-	16
		ZAUFAL-JANSEN , Hohlmeißelzangen	1032
		Zeichenfedern	25
Y			
YANKAUER , Saugkanülen	885, 1093, 1094		
YASARGIL , Mikro-Federscheren	52		
Rongeurs	908		
Saug- und Spülkanülen	1104		
YEOMAN , Biopsiezangen für Rektum	580		
YOUNG , Zungenzangen	16		
YOUNG-HRYNTSCHAK , Bumerang Nadelhalter	326, 623		
Z			
Zahnfleissscheren	12, 64-67, 69, 70		
Zahnfleissscheren, DUROTIP	92		
Zangen, Abfall-	19		
Abortus-	732-735		
Anlege-, Bulldogklemmen	786		
Arterienfass-	196		
Atraumatische Darmfass-	544, 545, 568		
Atraumatische Gallenblasen-	595		
Atraumatische Gewebefass-	544, 545, 835-837		
Atraumatische Kapselfass-	622		
Atraumatische Organfass-	191, 544, 545, 835-837		
Atraumatische Ovarien-	687		
Atraumatische Polypen-	687		
Biopsie-	699-704, 706		
Clipanlege-	738-745		
Darmfass-	538, 539, 541, 542		
Drahtbiege-	1069, 1071, 1073		
Drahtfass-	1067, 1070, 1071		
Drahtschneide-	1068, 1072-1078		
Drahtspann-	312, 1065, 1067, 1068		
Embolusfass-	846		
Extraktions- für Bohrdrähte	1070, 1071		
Fadenhalte-	326, 622		
Flach-	1069, 1070		
Fremdkörper-	200, 626		



	Seite
ZENKER , Präparier- und Ligaturklemmen	254
Wundhaken	427
ZIEGLER , Stirnbänder	2
Stirnspiegel	2
ZIELKE , Hohlmeißel für Skoliose-Operationen	1008
Zirkel, Becken-	720
ZOELLNER , Saugkanülen	1098, 1099
Zubehör, Stirnlampen	3
Zungenspatel	4, 348
Zungenzangen	16
ZWEIFEL , DUROGRIP Nadelhalter	323
Zwillingsklemmen, Darm-	556
Magen-	556
Zwischenknochenmesser	918

Seite

A - Z

Alphabetischer Index – Alphabetical Index

A

A-Z

	Page		Page
A		ALLIS-THOMAS , organ- and tissue grasping forceps	540
ABBEY , sub-mucosal resection needles	515	ALLISON , lung spatula	424, 881
Abdominal retractors	437-439, 441-448, 482, 483, 485-495	ALLPORT , self-retaining retractors	458
Abdominal retractors, fixation device	448	ALM , self-retaining retractors	457
mounting frame	449	Amniotome	722
Abdominal scissors	122	Amputation knives	28, 29, 917, 918
Abdominal spatula	435, 436, 451	Amputation retractors	920
ABEL , uterine tenaculum forceps	677	Amputation saws	921-923
ABRAHAM , tonsil knives	31	Anastomosis clamps	559, 843
ADAIR , uterine tenaculum forceps	674	Anastomosis clamps, ATRAUMATA	560, 791-793, 799, 808, 822, 823, 825, 828-831
Adapter, bipolar	522, 533	Anastomosis forceps, ATRAUMATA	563
Adapters, suction	1099	ATRAUMATA rectal	566
ADLERKREUTZ , vascular and tumor forceps	179	ATRAUMATA sigmoid	564
ADSON , bone rongeurs	1031	sigmoid	561, 562
burrs	1052	Anatomy scissors	68
delicate dissecting forceps	151, 152	ANDERSON-ADSON , self-retaining laminectomy retractors	468
delicate tissue forceps	168, 169	Angle clamps	612
dissecting forceps, bayonet-shaped	165	Angle clamps, ATRAUMATA	612
DUROGRIP non-traumatic dissecting forceps	162	ANGLE , wire cutters	1072
hemostatic forceps	225, 226	Anusscopes	572
monopolar diathermy forceps	517	Aorta clamps, ATRAUMATA	811, 816, 817, 832
needle holders	301	Aorta punches	852
nerve and vessel hooks	358	Aorta valve retractors	884
raspatories	968	Aorta-anastomosis clamps, ATRAUMATA	818, 819
self-retaining laminectomy retractors	468, 471	Aorta-aneurysm-clamps, ATRAUMATA	813-815
suction cannula	1094, 1095	Appendectomy clamps	557
tissue forceps	170	Applicators, cotton	347-351
ADSON-BABY , self-retaining retractors	463	Appliers, clip	738-745
ADSON-BROWN , tissue forceps	170	Applying forceps, bulldog clamps	216, 786
AESCLAP , biopsy forceps for rectum	581	Approximators	211, 212
DUROGRIP needle holders	323	Approximators, nerve	212
hand drills	1054	Arteriotomy scissors	80
placenta and ovum forceps	734	Artery grasping forceps	196
sponge- and dressing forceps	10, 186	ASCH , secretions scoops	626
swab holders	582	uterine secretion scoops	697
traction bows	1061	ASSMUS , nerve stripper	1046
AESCLAP-PRATT , organ- and tissue grasping forceps	198	ATRAUMATA coarctations clamps	827
uterine tenaculum forceps	680	ATRAUMATA, anastomosis clamps	560, 791-793, 799, 808, 822, 823, 825, 828-831
ALEXANDER , bone rongeurs	1029	aorta anastomosis clamps	818, 819
gouges	1001	aorta aneurysm clamps	813-815
raspatories	974	aorta clamps	811, 816, 817, 832
rib raspatories	863	bronchus clamps	812
ALLEN , intestinal clamps	547	bulldog clamps	218, 219, 788-790, 820, 821
osteophyte chisels and scraper	962	coarctation clamps	804, 826
ALLENBERG , ATRAUMATA vascular clamps	803	compression forceps	272
instruments for pulling through vascular grafts	854	dissecting forceps	160, 161, 546, 567, 782, 783, 797, 798
self-retaining retractor	461, 475	gall bladder forceps	595
ALLIS , artery grasping forceps	196	hemorrhoidal forceps	584
ATRAUMATA intestinal grasping forceps	544, 568	hemostatic forceps	794, 795
ATRAUMATA organ- and tissue grasping forceps	836	hysterectomy forceps and vaginal clamps	267
intestinal and tissue grasping forceps	196, 539	iliac clamps	807
lung grasping forceps	839		
ALLIS-ADAIR , tissue and intestinal forceps	538		



Alphabetischer Index – Alphabetical Index

A – B

A - Z

	Page		Page
ATRAUMATA, intestinal clamps	547, 548, 550, 552, 555	BABY-METZENBAUM NOIR dissecting scissors, Wavecut	106
intestinal grasping forceps	544, 545, 568	SuperCut scissors	91
kidney clamps	608, 796	BABY-MIKULICZ peritoneum forceps	257
kidney pedicle clamps	612	BABY-MIXTER dissecting and ligature forceps	244
ligature forceps	797, 798	BABY-MOSQUITO (HARTMANN) , hemostatic forceps	220
lobe grasping forceps	622	BABY-OVERHOLT , dissecting and ligature forceps	244
multi-purpose clamps	791-793, 809, 810, 824, 825, 828, 833, 834	BABY-ROUX retractors	379
organ grasping forceps	191, 544, 545, 835-837	BABY-SATINSKY , anastomosis clamps	843
ovum forceps	687	BABY-SENN-MILLER retractors	377
pankreas clamps	796	BACKHAUS , towel clamps	203
parametrium clamps	268	BACKHAUS-KOCHER towel clamps	203
patent ductus clamps	805, 806, 826, 827	BAILEY , rib contractors	877
pediatric vascular clamps	821	BAINBRIDGE , intestinal clamps	547
peripheral vascular clamps	805-807	BAKES , common bile duct dilators	601
polypus forceps	687	BALFOUR , Abdominal Retractors	488
pressure clamps	560, 612	BALFOUR-BABY , abdominal retractors	485
profunda clamps	798	Ball electrodes	510, 511, 514
rectal anastomosis forceps	566	Bandage scissors	131-133, 1082
sigmoid anastomosis forceps	563, 564	Bandages, compression	916
stomach clamps	557	BANE-HARTMANN bone rongeurs	1028
tangential occlusion clamps	801, 802	BARNES-NEVILLE obstetrical forceps	729
tissue grasping forceps	191, 544, 545, 835-837	BARRAQUER lid retractors	458
ultra-light-forceps	159, 546, 781	micro needle holders	283, 771
ureter forceps	624	BARRÉ , dissecting forceps	252, 619
vascular clamps	803	dissecting scissors	618
vascular clips	214, 215, 784, 785	prostate retractor	452, 620
vena cava clamps	800	suture holding frame	621
Atrium retractors	882, 883	urethral retractor	620
AUFRICHT , bone rasps	978	urethral retractor	452
AUSTIN , micro suture tying forceps	140	BARRON , hemorrhoidal ligators	586
AUVARD , vaginal specula	656	scalpel handle	38
Awls	1055, 1056	suction cannula	1097
		BARSKY , fine retractors	363
		BARTH , bone curettes	981
		BAUMGARTNER DUROGRIP needle holders	308
		DUROGRIP wire twisters	312, 1067
		needle holders	299
		Bayonet-shaped dissecting forceps	165, 166
B		BEACHAM , amniotome	722
BABCOCK ATRAUMATA intestinal grasping forceps	544	BECK , rongeurs	902
ATRAUMATA organ, tissue and intestinal grasping forceps	545	BECKMANN-ADSON self-retaining laminectomy retractors	470
ATRAUMATA organ- and tissue grasping forceps	835	BECKMANN-EATON self-retaining laminectomy retractors	471
lung grasping forceps	839	BEEBE , wire cutting scissors	129
organ- and tissue grasping forceps	540	BEHRMAN , uterine cannula	717
BABY-ADSON , dissecting and ligature forceps	245	BELLUCCI , suction cannula	1098
BABY-ALLIS , intestinal and tissue grasping forceps	538	Bending irons	1059
BABY-COLLIN , abdominal retractors	482	Bending pliers	1071
BABY-CRILE (KOCHER) , hemostatic forceps	222	BENGOLEA , hemostatic forceps	228
BABY-CRILE (PEAN) , hemostatic forceps	222	BENNETT , bone levers	945
BABY-CRILE-WOOD DUROGRIP needle holders	309	BENSAUDE , anoscopes	572
BABY-KOCHER ATRAUMATA intestinal clamps	547	BENSON , pylorus spreaders	557
intestinal clamps	547	BERGER , biopsy forceps	703
BABY-METZENBAUM dissecting scissors	87	BERGMANN , mallets	995
DUROTIP dissecting scissors	96	plaster scissors	135, 1083
DUROTIP dissecting scissors, Wavecut	102		
NOIR delicate dissecting scissors	105		

Alphabetischer Index – Alphabetical Index

B

A - Z

	Page		Page
BERGMANN , scalpels	26	Bone Rongeurs	1030
wound and tracheal retractors	364	Bone shears	116
BERKELEY-BONNEY , hysterectomy forceps	266	BONNER MODELL , micro suture tying forceps	139
BERNHARD , towel clamps	203	BONNEY , dissecting forceps	158
uterine tenaculum forceps	674	polypus- and ovum forceps	688
BERRY , DUROGRIP wire twisters	312, 1068	tissue forceps	177
BETHUNE , rib shears	857	Boomerang needle holders	326, 623
BEYER , bone rongeurs	1029, 1032	Boring wires	1058, 1059
BIEMER , approximator for nerves	212	BOROWSKI , aorta valve retractors	884
approximators	211	BORST , fixation clamps	842
clip applying forceps	210, 211	BOSE , self-retaining retractors	456
micro vein scissors	51	wound and tracheal hooks	364
vessel clips	210	Bougies, metal	600
BIEMER-MÜLLER , approximators	211	urethral	629, 630
BIER , amputation saws	922	Bowel scissors	125, 567
Biopsy curettes, endometrial	698	Bowls, round	1108
Biopsy forceps	699-704, 706	BOWMAN , probes	347
Biopsy forceps, attachments	581, 704, 705	Bows, traction	1060-1062
rectum	580-582	BOYS-ALLIS , artery grasping forceps	196
Bipolar adapter	522, 533	intestinal and tissue grasping forceps	196, 538
Bipolar clamps	531	BOZEMANN , uterine dressing forceps	672, 673, 675
Bipolar coagulation forceps	523-529	uterine scissors	119
Bipolar connecting cables	532-534	vaginal specula	658
Bipolar dissecting scissors	530	BOZEMANN-DOUGLAS , uterine dressing forceps	673, 675
Bipolar forceps	620	BRAITHWAITE , skin grafting knives	35
BIRCHER , meniscus- and cartilage forceps	1043	BRAND , tendon holding forceps	195
BIRCHER-GANSKE , meniscus- and cartilage forceps	1043	BRAUN , organ- and tissue grasping forceps	197
BIRKETT , hemostatic forceps	228	uterine depressor	671
BISHOP-HARMON , delicate tissue forceps	168	uterine tenaculum forceps	678
Bladder neck spreaders	622	vaginal specula	648
Bladder retractors	496, 617	BRAUN-STADLER , episiotomy scissors	124, 724
Bladder spatula	496, 617	sternum shears	856
Blades, microsurgical	45	Breakers, plaster	1087
scalpel	42, 43	BREISKY , vaginal specula	653
BLAKE , embolus grasping forceps	846	BRIDGE , hemostatic forceps	230
gall stone forceps	603	BRISTOW , bone levers	933
uterine curettes	711	BRODIE , directors	342
Blood scoops	453	rectal probes	579
BLOUNT , knee retractors	400, 1045	BROM , vein hooks	357
BLUMENTHAL , bone rongeurs	1028	Bronchus clamps, ATRAUMATA	812
Bone biopsy trephines	1057	Bronchus forceps	845
Bone clamps	1025	BROPHY , delicate dissecting forceps	155
Bone curettes	981-989	tissue forceps	173
Bone cutting forceps	859, 1038-1042	BROWN , tissue forceps	170
Bone drills	1055	BRUNELL , hand drills	1054
Bone files	978-980	BRUNNER , guiding probes	336
Bone holding forceps	1016-1024	ligature needles	336, 1056
Bone holding forceps, self-centering	1023	retractors	418, 419
Bone levers	932-945, 947-959	rib shears	858
Bone punches	892-898	sigmoid anastomosis forceps	561
Bone rasps	978-980	BRUNS , bone curettes	984, 987
Bone rasps, DUROGRIP	979	plaster scissors	135, 1084
Bone retractors	387, 388	BRYANT , sponge- and dressing forceps	184
		BRÜNINGS , extension cannula	705



Alphabetischer Index – Alphabetical Index

B – C

A - Z

	Page		Page
BRÜNNINGS , tongue spatula	4	CASPAR , rongeurs	904-906, 910
BUCHWALD , tongue spatula	4	scalpel handles	44
BUCK , cotton applicators	349	self-retaining retractors for spine	478, 479
BUCK-GRAMCKO , bone levers	932	tampers	997
Bulldog clamps	216, 217, 786, 787	CASTANEDA , ATRAUMATA anastomosis- and multi-purpose-clamps	791
Bulldog clamps, ATRAUMATA	218, 219, 788-790, 820, 821	CASTROVIEJO , delicate tissue forceps	168
Bulldog scissors	76	DUROGRIP needle holders	286, 287, 773, 774
BUMM , placenta- and ovum curettes	713	eye scissors	49
uterine curettes	710	micro needle holders	282, 770
BUNNEL , tendon passing probes	1048	micro scissors	48
tendon strippers	1047	Catheters introducing forceps	15
BUNT , safty pins	207	Catheters, urinary	627
BURKE , parametrium clamps	271, 692, 693	uterine irrigation	717
Burrs, trepanation	1052, 1053	CATLIN , amputation knives	28, 917
BUSHE , bone curettes	986	CAWTHORNE , cotton applicators	347
BÜCHS , cheek retractors	407	Cerclage wires	1065
raspatories	972	CHADWICK , delicate scissors	67
BÖHLER , bone cutting forceps	1040	CHAMPIONNIÈRE , bone drills	1055
bone rongeurs	1032	CHAPUT , artery grasping forceps	196
traction bows	1062	intestinal and tissue grasping forceps	196, 538
		CHARNLEY , tissue forceps	178
C		CHARRIÈRE , amputation saws	921, 922
Cables for elektrode handles	506, 513	CHEATLE , sterilizing forceps	1109
Cables, bipolar	532-534	Cheek retractors	405-407
monopolar	522	CHERON , sponge- and dressing forceps	189
CAIRNS , bone flap elevators	930	Chisels	998-1003, 1006-1008, 1010
dura retractors	360	Chisels, osteophyte	962, 998
hemostatic forceps	223	sternum	856
CAIRNS-DOTT , delicate dissecting forceps	154	Cholecystectomy forceps	592
Calculators, gestation	720	Chucks, drilling	1064
Calipers	8	Circumcision clamps	631
Cannula, coagulation	521, 1105	CITELLI , punches	892
hemorrhoidal	587	CITELLI-BEYER , punches	892
irrigation	598, 886, 1104	Clamps, anastomosis	559, 843
suction	885, 886, 1091-1102, 1104, 1105	appendectomy	557
uterine	716, 717	ATRAUMATA anastomosis	560, 791-793, 799, 808, 822, 823, 825, 828-831
vessel irrigation	846	ATRAUMATA aorta	811, 816, 817, 832
CANNY-RYALL , retractors	386	ATRAUMATA aorta aneurysm	813-815
CARBOTRAC retractor	412	ATRAUMATA aorta-anastomosis	818, 819
Cardiovascular scissors	108-111, 114	ATRAUMATA bronchus	812
Carotid shunt clamps	842	ATRAUMATA bulldog	218, 219, 788-790, 820, 821
CARREL , hemostatic forceps	220	ATRAUMATA coarctation	804, 826, 827
Cartilage forceps	1043	ATRAUMATA compression forceps	612
Cartilage knives	918	ATRAUMATA iliac	807
Cartilage scissors	81, 89	ATRAUMATA intestinal	547, 548, 550, 552, 555
Cartilage slitting knives	32	ATRAUMATA kidney	608, 796
Cases, needle	279	ATRAUMATA kidney pedicle	612
CASPAR , bone curettes	988, 989	ATRAUMATA multi-purpose	791-793, 809, 810, 824, 825, 828, 833, 834
knot tier	339	ATRAUMATA pankreas	796
nerve and vessel hooks	359	ATRAUMATA parametrium	268, 269
raspatories	969	ATRAUMATA patent ductus	805, 806, 826, 827
retractors	408		

Alphabetischer Index – Alphabetical Index

C

	Page		Page
Clamps, ATRAUMATA pediatric	821	COLLIN , ATRAUMATA organ- and tissue grasping forceps	191, 837
ATRAUMATA peripheral	805-807	clip removing forceps	352
ATRAUMATA pressure	272, 560	dressing and sponge holding forceps	192
ATRAUMATA stomach	557	hemostatic forceps	241
ATRAUMATA tangential occlusion	801, 802	intestinal grasping forceps	541
ATRAUMATA vaginal	267	kidney elevating forceps	613
ATRAUMATA vascular	803	organ- and tissue grasping forceps	192
ATRAUMATA vena cava	800	retractors	380
bipolar	531	sponge- and dressing forceps	189, 192
bone	1025	tongue forceps	16
bulldog	216, 217, 786, 787	umbilical cord clamps	724
carotid shunt	842	uterine curettes	711
circumcision	631	uterine elevating forceps	688, 689
colectomy	554	vaginal specula	636
fixation	842	COLLIN-HARTMANN retractors	378
gastro intestinal	556	Common bile duct dilators	601
intestinal	547-551, 553-556, 558	Compression apparatus	916
kidney	608-610	Compression bandages	916
kidney pedicle	611, 612	Compression forceps	273
parametrium	270, 271, 692, 693	Compression forceps, ATRAUMATA	272
penis	625	Conductors	925
pressure	273, 584, 612	Cone Knives	696
pylorus	558	CONE , hemi-laminectomy retractors	469
spermatic cord fixation	625	Contractors, rib	877
towel	201-206	CONVERSE DUROGRIP needle holders	307
tubing	17, 18	fine retractors	363
twin	556	needle holders	299
umbilical cord	724	COOLEY , ATRAUMATA anastomosis	792, 793, 825, 828
ureteral tunnel	254, 691	and multi-purpose clamps	
vascular	844	ATRAUMATA anastomosis clamps	822, 823, 829, 831
venous plexus	619	ATRAUMATA aorta clamps	832
CLAR , head lights	3	ATRAUMATA bulldog clamps	820, 821
CLAUS VAN EICKEN , ligature needles	333	ATRAUMATA coarctation clamps	826, 827
Clip applicator	738-745	ATRAUMATA dissecting forceps	161, 783
Clip applying forceps	210, 211, 352	ATRAUMATA multi-purpose clamps	824, 833
Clip removing forceps	352	ATRAUMATA patent-ductus clamps	826, 827
Clip, titanium ligature	738, 740, 742, 744	atrium retractors	882
Clips, ATRAUMATA vascular	214, 215, 784, 785	cardiovascular scissors	114
suture	352	sternum retractors	873
vessel	210, 213	COOLEY MODIF. STRUCK , atrium retractors	883
Cloth scissors	132-135, 1082	COOLEY-BECK , ATRAUMATA anastomosis clamps	822
CLOWARD , lamina spreaders	481	COOPER , ligature needles	334
CLOWARD MODIF. , self-retaining retractors for spine	480	surgical scissors	73
Coagulation cannula	521, 1105	Corneal forceps	151
Coagulation forceps, bipolar	523-527	Coronary scissors	59
Coarctation clamps, ATRAUMATA	804	CORYLLOS , retractors	425
Coarctations clamps, ATRAUMATA	826	COTTLE , bulldog scissors	76
COBB , raspatories	974	fine wound retractors	361
COBBETT , skin grafting knives	35	fishtail osteotomes	1001
Colectomy clamps	554	fixation forceps	165
COLLER , hemostatic Forceps	224	mallets	992
COLLEY , delicate dissecting forceps	155, 783	osteotomes	1001
COLLIN , abdominal retractors	482	raspatories	965, 969
ATRAUMATA intestinal grasping forceps	544	wound and vein retractors	373



Alphabetischer Index – Alphabetical Index

C - D

A - Z

	Page		Page
COTTLE-KNAPP , dissecting scissors	77	DE BAKEY , ATRAUMATA coarctation clamps	804
COTTLE-MASING , dissecting scissors	77	ATRAUMATA dissecting and ligature forceps	798
Cotton applicators	347-351	ATRAUMATA dissecting forceps	160, 161, 546, 567, 782, 783
CRAFOORD , hemostatic forceps	229	ATRAUMATA iliac clamps	807
vascular clamps	844	ATRAUMATA multi-purpose clamps	809, 810
CRAFOORD MODIF. , hemostatic forceps	230	ATRAUMATA patent-ductus clamps	805, 806
CRAFOORD-SELLORS , vascular clamps	844	ATRAUMATA peripheral vascular clamps	805-807
CRILE , hemostatic forceps	222, 224	ATRAUMATA tangential occlusion clamps	801
needle holders	305	cardiovascular scissors	110
nerve and vessel hooks	357	dissecting scissors	80
retractors	379	DUROGRIP needle holders	313, 314, 776, 777
CRILE-MURRAY , needle holders	300	DUROTIP gall duct scissors	597
CRILE-WOOD , DUROGRIP needle holders	309	DUROTIP vascular scissors	100
needle holders	300	femur retractors	473
Curettes vacuum	714, 1090	offset scissors	111
Curettes, bone	981-989	rib spreaders	870, 871
endometrial biopsy	698	suction cannula	885, 1094
ovum	713	vascular dilators	847
placenta	713	DE BAKEY (LAMBERT MODIF.) , ATRAUMATA	819
uterine	708-711	aorta anastomosis clamps	
CUSCO , vaginal specula	637, 638	DE BAKEY (MORRIS MODIF.) , ATRAUMATA aorta clamps	811
CUSHING , burrs	1052	ATRAUMATA sigmoid anastomosis forceps	563
delicate dissecting forceps	155	DE BAKEY-BAINBRIDGE , ATRAUMATA hemostatic forceps	794
DUROGRIP dissecting forceps	164	DE BAKEY-BECK , ATRAUMATA vena cava clamps	800
nerve and vessel hooks	357, 359	DE BAKEY-HARKEN , ATRAUMATA vena cava clamps	800
rongeurs	902, 903, 906	DE BAKEY-HESS , bulldog clamps	217, 787
tissue forceps	173	DE BAKEY-MC QUIGG-MIXTER , ATRAUMATA	797
wound and vein retractors	375, 376	dissecting and ligature forceps	
CUSHING-KOCHER , wound and vein retractors	374	DE BAKEY-MIXTER , ATRAUMATA	797
Cutters heads, Elektra II	9	dissecting and ligature forceps	
Cutters, nail	12	DE BAKEY-PEAN , ATRAUMATA hemostatic forceps	795
wire	1072-1074, 1076-1078	DE BAKEY-RUMEL , dissecting and ligature forceps	797
Cutting electrodes	509	DE BAKEY-SATINSKY , ATRAUMATA	802
Cystic forceps	591, 593	tangential occlusion clamps	
CZERNY , gall stone forceps	604	DE LEE , pelvimeters	720
organ- and tissue grasping forceps	197	DE MARTEL , conductors	925
rectal specula	570	DE MARTEL-WOLFSON , anastomosis clamps	559
retractors	384	closing forceps	559
uterine tenaculum forceps	679	DEAVER , retractors	429-434
		surgical scissors	75
		Delicate dissecting forceps	153, 783
		Delicate dissecting scissors	62, 76, 78, 80, 81
		Delicate dissecting scissors, NOIR	105
		Delicate hemostatic forceps	220-230
		Delicate scissors	61, 63-70
D		DEMEL , wire guides	1066
DANDY , hemostatic forceps	221	wire tightening- and twisting forceps	1065
DARTIGUES , kidney elevating forceps	613	DENIS-BROWNE , abdominal retractors	490
uterine elevating forceps	689	intestinal dissecting forceps	543
DAUBENSPECK , bone curettes	985	intestinal forceps	180
DAVIDSON , scapula retractors	426, 880	Depressors	453
DAVIS , vascular spatula	850	Depressors, uterine	671
DE BAKEY , arteriotomy scissors	80	DERF , DUROGRIP needle holders	307
ATRAUMATA anastomosis- and multi-purpose clamps	792	needle holders	299
ATRAUMATA aorta aneurysm clamps	813-815		
ATRAUMATA aorta clamps	817		
ATRAUMATA bulldog clamps	218, 219, 788-790		

Alphabetischer Index – Alphabetical Index

D

	Page		Page
Dermal punches	33	Dissecting suction tubes	1103
Dermatomes	34, 35	Dissectors	849, 850, 928, 929
DERRA , ATRAUMATA anastomosis- and multi-purpose clamps	793	Dissectors, phlebo suction	889 1103
DERRA-COOLEY , ATRAUMATA anastomosis clamps	823	tonsil suction	1103
DESCHAMPS , ligature needles	329-333	Distractor	1014
DESJARDINS , dissecting and ligature forceps	256	DITTEL , metal bougies and dilating sounds	600
gall duct probes	599	urethral bougies and dilating sounds	629
gall duct- and cystic forceps	591	DIXON-LOVELACE , hemostatic forceps	225
gall stone forceps	605	DOCKHORN , retractors	408
gall stone scoops	602	Double ended probes	346
DESMARRES , wound and vein retractors	373	DOYEN , abdominal retractors	444, 446
DIADUST micro forceps	145, 147, 149, 150, 753, 755, 757, 769	ATRAUMATA intestinal clamps	548, 550
DIADUST micro needle holders	289, 291-298, 759-767, 769	directors	342
DIADUST needle holders	767	gall bladder forceps	596
Diathermy forceps, monopolar	516-519	intestinal clamps	548-550
DICK , ATRAUMATA anastomosis clamps	808	myoma screw	690
ATRAUMATA compression forceps	272	needle holders	299
ATRAUMATA pressure clamps	560	polypus- and ovum forceps	687
DIEFFENBACH , bulldog clamps	216, 786	raspatories	976
DIETHRICH , ATRAUMATA aorta clamps	816	rib raspatories	861
cardiovascular scissors	110	towel clamps	202
micro bulldog clamps	217, 787	vaginal specula	650, 651, 654
DIETHRICH-HEGEMANN , cardiovascular scissors	110	DOYEN-CHILD , abdominal retractors	447
Dilating sounds, gall duct	600	Draw-in forceps, vascular grafts	854
urethral	629, 630	Dressing forceps	10, 184-190, 192, 193
Dilators, common bile duct	601	Drilling chucks	1064
gall duct	600	Drills	1054, 1055
tracheal	474	Drills, trepanation	1052, 1053
umbilical	724	Ductus clamps, ATRAUMATA	805, 826, 827
uterine	662-666	DUNHILL , hemostatic forceps	222, 227
vascular	847, 848	DUPLAY , sponge- and dressing forceps	185
DINGMANN , bone holding forceps	1017	uterine tenaculum forceps	677
DINGMANN MODIF. , bone holding forceps	1017	Dura hooks	361-363
Directors	342, 579	Dura retractors	360
Directors, grooved	929	Dura scissors	112
with wire loops	343, 579	DURHAM , retractors	405
Disposable scalpels	22-24	DUROGRIP, bone rasps	979
Dissecting forceps	156-158, 244-256, 619, 840, 841	dissecting forceps	162-164
Dissecting forceps, angular	167	micro needle holders	774
ATRAUMATA	160-162, 546, 567, 782, 783, 797, 798	needle holders	286, 287, 307-310, 312- 325, 568, 773-779
bayonet-shaped	166	needle holders with scissors	311
delicate	151-155, 783	suture forceps	163, 178
DUROGRIP	162-164, 543	wire holding forceps	1067
Dissecting hooks	376	wire twisters	312, 1067, 1068
Dissecting scissors	76, 77, 79-89, 618	DUROTIP ligature scissors	104
Dissecting scissors, bipolar	530	DUROTIP scissors	92-100, 597
delicate	62, 63, 76, 78, 80, 81	DUROTIP uterine scissors	103
DUROTIP	94-99, 101-103	DUROTIP Wavecut scissors	101-103
micro	53	DUROTIP wire cutting scissors	100
nerve	63	DUVAL , intestinal dissecting forceps	543
NOIR	105-107	intestinal forceps	180
		intestinal grasping forceps	542



Alphabetischer Index – Alphabetical Index

D - F

A - Z

	Page		Page
DUVAL , lung grasping forceps	839	FARRELL , cotton applicators	348, 350
DUVAL-COLLIN , intestinal grasping forceps	541	FAURE , biopsy forceps	700
		peritoneum forceps	260
E		FAVOLORO , cardiovascular scissors	111
Ear hooks	356	FEILCHENFELD , splinter forceps	181
EAST GRINSTEAD (WARD) , chisels	1002	Femur retractors	473
osteotomes	1002	FERGUSSON , bone holding forceps	1018
EASTMAN , chisels	1002	pressure clamps	584
vaginal specula	652	suction cannula	1095, 1096, 1102
ECHLIN , bone rongeurs	1033	FERGUSSON-ACKLAND , mouth gags	14
ECKHOFF , mapping pen	25	FERRIS-SMITH , DUROGRIP dissecting forceps	163
Electric hair clippers	9	Fibre light attachment	574, 575
Electrode handles	506-508, 513	Fibre light carrier	575
Electrode handles, single use	508	FICKLING , hemostatic forceps	237
Electrodes, ball	510, 511, 514	Files, bone	978-980
cutting	509	nail	13
knife	509, 511	Fine retractors	360, 363
loop	509, 514	Fine wound retractors	361, 362
needle	509-512, 514	Finger goniometer	8
plate	510	Finger ring saws	1079
wire loop	511, 512	FINOCHIETTO , dissecting and ligature forceps	251, 840
Elevators	930, 931, 963	DUROGRIP needle holders	318
Embolus grasping forceps	846	rib spreaders	866-868
EMMET , fistula hooks	372	thoracic retractors	864, 865
sponge- and dressing forceps	189	FINOCHIETTO-BURFORD , rib spreaders	869
Endarterectomy strippers	851	FINSEN , self-retaining retractors	456
Endometrial biopsy curettes	698	FINSEN MODIF. , self-retaining retractors	456
Endospecula for cervix and urethra	667	FINSTERER , suction and irrigation cannula	886, 1104
ENGEL , plaster saws	1082	FISCH , dura retractors	363
ENGL. MOD. , towel clamps	201	Fistail osteotomes	1001
Enucleation scissors	77	Fistula hooks	372
Episiotomy scissors	124, 724	Fistula knives	30
EPPENDORF , biopsy forceps	703	Fistula probes	343, 579
ESMARCH , compression bandage	916	Fixation clamps	842
plaster knives	1082	Fixation device, abdominal retractors	448
plaster scissors	135, 1083	Fixation forceps	165
Ethmoidal forceps	899-901	Flap knives	28, 917
Exploration hooks	359	Flat-nosed pliers	1069, 1070
Extension cannula	705	FOMON , bone files	979
Extraction pliers for boring wires	1070, 1071	lower lateral scissors	77
Extractors, phleb	889	rasps	979
Eye forceps	168	retractors	370
Eye scissors	49	Forceps, applying, bulldog clamps	216, 786
		artery grasping	196
F		ATRAUMATA compression	272
FARABEUF , bone holding forceps	1019	ATRAUMATA dissecting	160-162, 782, 783, 797, 798
raspatories	971	ATRAUMATA gall bladder	595
retractors	379	ATRAUMATA hemorrhoidal	584
FARABEUF-COLLIN , raspatories	971	ATRAUMATA hemostatic	794, 795
FARABEUF-LAMBOTTE , bone holding forceps	1019	ATRAUMATA hysterectomy	267
		ATRAUMATA intestinal	544, 568
		ATRAUMATA intestinal grasping	544, 545
		ATRAUMATA ligature	797, 798
		ATRAUMATA lobe grasping	622

Alphabetischer Index – Alphabetical Index

F

	Page		Page
Forceps, ATRAUMATA organ grasping	191, 544, 545, 835-837	Forceps, kidney elevating	613
ATRAUMATA ovum	687	kidney stone	614-616
ATRAUMATA polypus	687	ligature	158, 244-256, 840, 841
ATRAUMATA rectal anastomosis	566	ligature holding	326, 622
ATRAUMATA sigmoid anastomosis	563, 564	lung grasping	180, 838, 839
ATRAUMATA tissue grasping	191, 544, 545, 835-837	malleolar	1016
ATRAUMATA ultra-light	159, 781	membrane puncturing	722
biopsy	699-704, 706	meniscus	1043
biopsy for rectum	580-582	micro	139-143, 145, 147, 149, 753, 755, 757, 769
bone cutting	859, 1038-1042	micro, jeweler patterns	138
bone holding	1016-1024	micro, suture tying	139
bone holding, self-centering	1023	monopolar diathermy	516-518, 520
bronchus	845	nail extracting	1079
caesarean section	730, 731	nail splitting	1079
cartilage	1043	obstetrical	726-729
catheters introducing	15	organ grasping	190, 192, 193, 197-199, 540, 543, 839
cholecystectomy	592	ovum	685-688, 732-735
clip applying	210, 211, 352	patella	1016
clip removing	352	peritoneum	257-260
closing	559	pick-up	19
coagulation, bipolar	523-529	placenta	732-735
compression	273	polypus	685-688
corneal	151	reposition	1014-1016
cross ligament passing	195	rib holding	859
cystic	591, 593	scalp flap	731
delicate	783	sequestrum	1017
DIADUST	145, 147, 149, 150, 753, 755, 757, 769	sigmoid anastomosis	561, 562
dissecting	156-158, 163, 164, 244- 256, 619, 840, 841	sinus	184
dissecting, angular	167	splinter	181
dissecting, bayonet-shaped	165, 166	sponge	10, 185-190
dissecting, delicate	151-155	sponge holding	184, 192, 193
dissecting, diathermy	519	sterilizing	1109
dressing	10, 184-190, 192, 193	suture	163, 178
dressing nasal	165-167	suture tying	139, 140, 143
DUROGRIP	162, 163, 178	tendon holding	195
embolus grasping	846	tendon interlacing	194
ethmoidal	899-901	tendon passing	195
eye	168	tendon seizing	194
fixation	165	tissue	168, 170, 173-179
foreign body	200, 626	tissue grasping	190, 192, 193, 196-199, 538-540, 543
foreskin grasping	625	tissue, delicate	168, 169, 171, 172
gall bladder	594-596	tongue	16
gall duct	590-593	tonsil	240
gall stone	603-605	tumor	179
grasping for ligamentum flavum	913	tumor grasping	909
hemorrhoidal	583, 585	ureter, ATRAUMATA	624
hemostatic	231-241	uterine dressing	672, 673, 675
hemostatic, delicate	220-230	uterine elevating	688, 689
Hysterectomy	262	uterine tenaculum	674-684
intestinal	180, 543	vascular	179
intestinal dissecting	543	wire cutting	1068
intestinal grasping	538, 539, 541, 542		



Alphabetischer Index – Alphabetical Index

F – G

A – Z

	Page		Page
Forceps, wire holding	1070, 1071	GIGLI , wire saws	924
wire holding, DUROGRIP	1067	GILLIES , delicate dissecting forceps	154
wire tightening	1065	delicate tissue forceps	172
wire twisting	1065	DUROGRIP needle holders with scissors	311
Foreign body forceps	200, 626	fine retractors	362
Foreskin grasping forceps	625	monopolar diathermy forceps	517
FORMBY , suction cannula	1097	needle holders with scissors	304
FOWLER , tonsil knives	31	osteotomes	999
Frame, suture holding	621	suction cannula	1101
FRASER-KELLY (CRILE) , hemostatic forceps	226	GLASSER , DIADUST micro needle holder	296, 766
FRAZIER , dura retractors	360	GLOVER , ATRAUMATA anastomosis clamps	799
suction cannula	1096	ATRAUMATA bulldog clamps	218, 219, 788, 789
FREER , chisels	998	GLUCK , rib shears	857
dissectors	849	GOELET , Retractor	386
fine retractors	361	GOLDMAN-FOX , DUROTIP scissors	92
gouges	998	GOLIGHER , abdominal retractors	488
raspatories	963-965	Goniometers	8
FREER-YASARGIL , raspatories	965	GORNEY , dissecting scissors	81
FRIEDMAN , bone rongeurs	1026	suction dissectors	1103
FRITSCH , abdominal retractors	445	SuperCut scissors	90
FRYKHOLM , bone rongeurs	1033	GOSLEE , wire bending pliers	1069
FUCHSIG , hemostatic forceps	225	GOSSET , abdominal retractors	485
FÖRSTER-BALLENGER , gall bladder forceps	594	Gouges	998-1001, 1003, 1007, 1008, 1010, 1011
sponge holding and dressing forceps	190	Gouges, lamina	1009
		scoliosis operations	1008
		spongiosa	1009, 1010
G		GOULIAN , skin grafting knives	34
GABRIEL , hemorrhoidal cannula	587	GOURDET , uterine scoops	707
hemorrhoidal syringes	587	GRAEFE , dissecting scissors	76
rectal specula	573	nerve- and vessel hooks	356
Gags, mouth	14, 15	skin hooks	360
GALABINS , uterine probes	670	tissue forceps	170
Gall bladder forceps	594-596	Grasping forceps for ligamentum flavum	913
Gall bladder forceps, ATRAUMATA	595	Grasping forceps, artery	196
Gall bladder scissors	596	ATRAUMATA intestinal	544, 545, 568
Gall duct dilators	600	ATRAUMATA lobe	622
Gall duct forceps	590-593	ATRAUMATA organ	191, 544, 545, 835-837
Gall duct probes	598, 599	ATRAUMATA tissue	191, 544, 545, 835-837
Gall duct scissors	597	embolus	846
Gall duct scissors, DUROTIP	597	foreskin	625
Gall stone forceps	603-605	intestinal	180, 538-543
Gall stone scoops	602	lung	838, 839
GALLAHER , bone files	978	organ	197-199, 540, 543
GARRETT , vascular dilators	848	tissue	196-199, 538-540, 543
Gastro-intestinal clamps	556	tumor	909
GELPI , skin retractors	473	uterine	197
vaginal retractors	473, 659	GRAVE , vaginal specula	640
GEMINI , dissecting and ligature forceps	248	GRAY , cholecystectomy forceps	592
GERALD , delicate dissecting forceps	154	dissecting and ligature forceps	256
delicate tissue forceps	172	GREEN-ARMYTAGE , caesarean section hemostatic forceps	730, 731
micro forceps	149, 757	GREENE , cheek retractors	406
Gestation calculators	720	GREGORY , atraumatic profunda clamps	798
GIERTZ-STILLE , rib shears	858	GREY-TURNER , hemostatic forceps	227

Alphabetischer Index – Alphabetical Index

G - H

A - Z

	Page		Page
Grooved directors	929	Head mirrors	2
GROSS , sponge- and dressing forceps	10, 185	HEANEY , ATRAUMATA hysterectomy forceps	267
GRUENWALD , dissecting forceps, bayonet-shaped	166	DUROGRIP needle holders	315
DUROGRIP dissecting forceps	164	hysterectomy forceps	261
Guide needles	353	needle holders	302
Guides, wire	1066	uterine curettes	711
Guiding probes	336-338	vaginal specula	652
GULEKE , bone rongeurs	1030	HEANEY MODIF. , hysterectomy forceps	261
GUTHRIE , skin hooks	360	HEANEY-BALLENTINE , Hysterectomy Forceps	262
GUYON , ATRAUMATA kidney clamps	608	HEANEY-REZEK , Hysterectomy Forceps	261
kidney clamps	608-610	HEATH , clip removing forceps	352
urethral bougies and dilating sounds	630	mallets	996
GWILLIAM , hysterectomy forceps	266	HEGAR , DUROGRIP needle holders	310
Gynecology scissors	117-121	needle holders	302
		uterine dilators	662-664
		HEGAR-MAYO , DUROGRIP needle holders	310
		HEGAR-MAYO-SEELEY , DUROGRIP needle holders	309
		HEGAR-OLSEN , DUROGRIP needle holders with scissors	311
		needle holders with scissors	304
		HEGAR-OLSEN MODIF. LANGE ,	311
		DUROGRIP needle holders with scissors	
		HEGENBARTH , clip applying forceps	352
H		HEIMING , kidney stone forceps	614
HAASE , reposition forceps	1014	HEISS , dissecting and ligature forceps	250
HABERER , abdominal and intestinal spatula	450	hemostatic forceps	227
HAIGHT , rib spreaders	867	HEISTER , mouth gags	14
Hair clippers, electric	9	HELLBERG/KUPKA , DUROGRIP needle holders	321, 775
HAJEK , irrigation cannula	598	Hemi-laminectomy retractors	469
mallets	993	HEMINGWAY , bone curettes	982
retractors	385	Hemorrhoidal cannula	587
HAJEK-KOFLER punches	893, 894	Hemorrhoidal forceps	583, 585
HAKANSSON , bone rongeurs	1028	Hemorrhoidal forceps, ATRAUMATA	584
HALLE , bone curettes	985	Hemorrhoidal ligators	585, 586
dissectors	849	Hemorrhoidal syringes	587
elevators	963	Hemostatic forceps	231-241
HALSEY , DUROGRIP needle holders	307, 308	Hemostatic forceps, ATRAUMATA	794, 795
needle holders	299	caesarean section	730, 731
HALSTED , hemostatic forceps	225	delicate	220-230
HALSTED-MOSQUITO , hemostatic forceps	220, 226	HENCKEL-TILLEY , rongeurs	900
Hand drills	1052-1054	HENDERSON , self-retaining retractors	465
Hand fixation plate	1049	HENNIG , plaster spreaders	1087
Handles, electrode	506-508, 513	HERFF , membrane puncturing forceps	722
scalpel	38-41, 44, 45, 618	HERRICK , kidney pedicle clamps	611
suction	1092	HERTZLER , abdominal retractors	485
VARIO retractor system	421	rib spreaders	866
HARRINGTON , lung spatula	422, 878	HERZ , tendon seizing forceps	194
retractors	422	HESS , nerve root retractors	376
HARRINGTON-PEMBERTON lung spatula	879	HEY GROVES , bone holding forceps	1022
retractors	423	HEYWOOD-SMITH , gall bladder forceps	594, 595
HARTMANN , ATRAUMATA intestinal clamps	548	hemorrhoidal forceps	583
cotton applicator	351	organ- and tissue grasping forceps	193
intestinal clamps	548	polypus and ovum forceps	685, 686
tuning forks	6	sponge holding and dressing forceps	192, 193
HARVEY , wire cutting pliers	1074	tongue forceps	16
wire cutting scissors	129, 1073		
HARVEY JACKSON , self-retaining laminectomy retractors	470		
HASSON , retractors	428		
Head lights	3		
Head lights, accessories	3		



Alphabetischer Index – Alphabetical Index

H - J

A - Z

	Page		Page
HEYWOOD-SMITH MODIF. , gall bladder forceps	596	I	
hemorrhoidal forceps	583	Iliac clamps, ATRAUMATA	807
sponge holding and dressing forceps	192	Iliaca retractor	475
HIBBS , osteotomes	1004	ILNER , fine retractors	363
retractors	946	Incisions scissors	75
HILL , raspatories	965	INGE , lamina spreaders	481
Hip retractors	947-959	Ink pot	25
HOHMANN , bone levers	940	Instruments oil	1112
HOHMANN-ALDINGER , bone levers	943	Instruments, tunneling	853
Holders, clamp	559	Interosseus knives	918
needle	299-303, 305	Intestinal clamps	547-551, 553-556, 558
needle, DUROGRIP	286, 568	Intestinal clamps, ATRAUMATA	547, 548, 550, 552, 555
needle, with scissors	304	Intestinal dissecting forceps	543
swab	582	Intestinal forceps	180, 543
Hollow mills	1057	Intestinal grasping forceps	538, 539, 541, 542
HOLZBACH , abdominal retractors	483	Intestinal grasping forceps, ATRAUMATA	544, 545, 568
hysterectomy forceps	265	Intestinal needles	278
Hooks, coagulation	359	Intestinal spatula	435, 436, 450, 451
dissecting	376	Irrigation cannula	598, 886, 1104
dura	361-363	Irrigation cannula, vessel	846
ear	356	IRWIN , self-retaining retractors	467
exploration	359	ISRAEL , retractors	393
fistula	372	IVES-FANSLER , anoscopes	572
I.U.D. removing	697		
nerve	356-359, 376	J	
saddle	369	JACKSON , tendon seizing forceps	194
skin	360-363	vaginal specula	650
spermatic cord	625	JACKSON-BURROWS , self-retaining retractors	472
tendon	373	tissue forceps	177
tendon double	369	JACOBS , uterine tenaculum forceps	682
tracheal	364	JACOBSON , bone curettes	981
vein	357	hemostatic forceps	221, 226
vessel	356-359	micro needle holders	282, 770
wound	364	micro scissors	52
HOPT , ATRAUMATA kidney and pancreas clamps	796	JAMESON , dissecting scissors	79
HOUSE , suction adapter	1099	needle holders	302
suction and irrigation cannula	1104	SuperCut scissors	90
HOWARTH , raspatories	964	JAMESON-WERBER , dissecting scissors	79
HUDSON , burrs	1052	JANSEN , bone curettes	981, 982
delicate dissecting forceps	151	bone rongeurs	1028, 1029
hand drills	1052	dissecting forceps, bayonet-shaped	165
tissue forceps	170	raspatories	972
HUDSON DOWNS , burrs	1053	self-retaining retractors	458
hand drills	1053	JAVID , Carotid shunt clamps	842
HUMBY , skin grafting knives	35	JEFFERSON , delicate dissecting forceps	152
HUNTER , splinter forceps	181	delicate tissue forceps	169
HURD , ligature needles	332	self-retaining retractors	464
Hysterectomy Forceps	262	JENKNER , instruments for tunneling	853
Hysterectomy forceps, ATRAUMATA	267	and pulling-through vascular grafts	
Hysterectomy scissors	120	JOHNS-HOPKINS , applying and removing forceps	216, 786
Hysterectomy scissors, DUROTIP	100	bulldog clamps	216, 786
HÖSEL , DUROGRIP needle holders	324	JOLL (FRIEDMAN) , thyroid- and vaginal retractors	472, 659
retractors	411, 569		

Alphabetischer Index – Alphabetical Index

J – K

A – Z

	Page		Page
JONES , towel clamps	201	KILNER , dissecting scissors	79
JONESCO , ligature needles	333	DUROGRIP needle holders	308
JOSEPH , bone files	978	fine retractors	361
delicate scissors	61, 70	needle holders	300
nasal knives	32	retractors	377, 383
raspatories	961	KING COLLEGE HOSPITAL , cotton applicator	349
skin hooks and retractors	362	KIRSCH , retractors	405
SuperCut scissors	90	KIRSCHNER , abdominal retractors	494, 495
JUDD-ALLIS , organ- and tissue grasping forceps	540	boring wires	1058, 1059
JÄGER , skin hooks	362	guiding probes	338
tendon- and cross ligament passing forceps	195	traction bows	1060
		KLAPP , tendon hooks	373
		Kleiderscheren	1082
K		KLEINERT-KUTZ , tendon passing forceps	195
KADER , abdominal and intestinal spatula	451	KLEINSCHMIDT , appendectomy clamps	557
KALLMORGEN , vaginal specula	646	KLIMA-ROSEGGGER , sternal puncture needles	634
KANTROWITZ , dissecting and ligature forceps	252	KLINIKUM BERLIN , tubing clamps	17
KAZANJIAN , bone cutting forceps	1038	KLINKENBERG-LOTH , vascular scissors	115
KELLY , abdominal retractors	439	Knee retractors	399, 400, 1045
delicate scissors	70	Knife electrodes	509, 511
dressing and sponge holding forceps	193	Knives, amputation	28, 29, 917, 918
hemostatic forceps	221	cartilage	918
organ- and tissue grasping forceps	193	cartilage slitting	32
placenta and ovum forceps	734	cone	696
polypus and ovum forceps	685	fistula	30
proctoscopes	573	flap	28, 917
retractors	415	interosseus	918
sphincteroscopes	572	meniscus	1044
KERN-LANE , bone holding forceps	1020, 1021	nasal	32
KERN-MINI , bone holding forceps	1021	periosteum	29, 918
KERPEL , bone curettes	983	phalangeal	29, 918
KERRISON , punches	892, 898	plaster	1082
punches, detachable	896-898	resection	29, 918
KERSTING , ATRAUMATA sigmoid anastomosis forceps	564	skin grafting	34, 35
KEY , raspatories	972	tonsil	31
KEYES , dermal punches	33	trigeminal	31
KEYES MODIF. , dermal punches	33	Knot tier	339
Kidney clamps	608-610	KNOWLES , bandage scissors	131
Kidney clamps, ATRAUMATA	608, 796	KOCHER , ATRAUMATA intestinal clamps	552
Kidney elevating forceps	613	bone retractors	387
Kidney pedicle clamps	611, 612	depressors	453
Kidney pedicle clamps, ATRAUMATA	612	guiding probes	337
Kidney stone forceps	614-616	hemostatic forceps	235
Kidney trays	1108	intestinal clamps	549, 551
KIEBACK , parametrium scissors	120, 121, 692, 693	ligature needles	335
ureteral tunnel clamps	254, 691	retractors	387, 389, 390, 403, 409
KIELLAND , obstetrical forceps	726	wound and vein retractors	374
KILLIAN , bone shears	116	KOCHER-LANGENBECK , retractors	396
probes	347	KOCHER-OCHSNER , hemostatic forceps	236
raspatories	964	KOCHER-WAGNER , retractors	410
rectal specula	570	KOFLER , punches	894
KILNER , cheek retractors	383	KOGAN , endospecula	667
delicate dissecting scissors	76	endospecula for cervix and urethra	667
		KRAUSE , biopsy tips	705



Alphabetischer Index – Alphabetical Index

K - L

A - Z

	Page		Page
KRAYENBÜHL , nerve and vessel hooks	358	LANE TRETHOWAN , bone levers	933
KRISTELLER , vaginal specula	641-645, 647	LANG-STEVENSON , intestinal clamps	554
KRONECKER , ligature needles	329	LANG , fistula hooks	372
Krypt hooks	579	LANG - HOHMANN , bone levers	934
KRÄMER , chisels for osteophytes	998	LANG - HOHMANN MODIF. , bone levers	935
grasping forceps for ligamentum flavum	913	LANGENBECK , amputation saws	923
raspatories	971, 972	bone holding forceps	1018
retractors	407	DUROGRIP needle holders	322
rongeurs	909	elevators	931
KRÖNLEIN , hemostatic forceps	231	flap knives	28, 917
KÜMMEL , retractors	436	raspatories	971, 972
KÜSTNER , uterine tenaculum forceps	681	resection knives	29, 918
KÖNIG , elevators	930	retractors	394, 395, 398
guiding probes	337	rib raspatories	863, 972
raspatories	960	LANGENBECK-GREEN , retractors	370
wound and vein retractors	374	LANGENBECK-MANNERFELTMODIF. ,	368
KÖRTE , retractors	392, 436	retractors with treangle handle	5
KÖRTE-WAGNER , retractors	392	Laryngeal mirrors	348, 350
		LATHBURY-FARRELL , cotton applicators	253
		LAWRENCE , dissecting and ligature forceps	301
		needle holders	140
		LAZAR , micro suture tying forceps	1049
		Lead hand	925
		LEBSCH , conductors	856
		sternum chisels	704
L		LEECH-WILKINSON , biopsy forceps	716
LA GRANGE , delicate scissors	69	uterine cannula	812
LABORDE , tracheal dilators	474	LEES , ATRAUMATA bronchus clamps	812
LAHEY (SWEET) , dissecting and ligature forceps	255	LEGUEU , bladder spatula	496, 617
LAHEY , dissecting and ligature forceps	255	LEITZ , ATRAUMATA anastomosis clamps	828
gall duct forceps	590	LEKSELL , bone rongeurs	1033
organ- and tissue grasping forceps	197	LEKSELL-STILLE , bone rongeurs	1034
retractors	404	LELAND-JONES , ATRAUMATA, peripheral vascular clamps	807
uterine tenaculum forceps	678	LEMPERT , bone curettes	985
LAMBERT-KAY , ATRAUMATA aorta anastomosis clamps	819	bone rongeurs	1029
LAMBOTTE , bone holding forceps	1024	raspatories	962
osteotomes	1001, 1005	LERICHE , hemostatic forceps	223
raspatories	973	retractors	435
rib raspatories	863	Levers, bone	932-945, 947-959
Lamina gouges	1009	luxation	945, 947
Lamina spreaders	481	obstetric	730
Laminectomy retractors, self-retaining	468, 470, 471, 476-478	LEWIN , bone clamps	1025
LANCASTER , lid retractors	458	LEWIS , bone rasps	978
LANDAU , vaginal specula	653	LEXER , dissecting scissors	85
LANDOLT , coagulation and suction cannula	521, 1105	DUROTIP dissecting scissors	95, 101
dissecting suction tubes	1103	gouges	1008
enucleation scissors	77	NOIR dissecting scissors, Wavecut	107
raspatories	969	osteotomes	1008, 1010
scalpel handles	45	spongiosa gouges	1010
tumor grasping forceps	909	LEXER-MINI , gouges	1007
LANDON , vaginal specula	651	osteotomes	1007
LANE , bone holding forceps	1020, 1021	LICHTENBERG , DUROGRIP needle holders	324
bone levers	933	Lid retractors	458
gastro-intestinal twin forceps	556	Ligators, hemorrhoidal	585, 586
organ- and tissue grasping forceps	543		
retractors	384		
tissue forceps	176		
towel clamps	202		



Alphabetischer Index – Alphabetical Index

M

A - Z

	Page		Page
MAYO , safty pins	207	Micro ligature scissors	60
SuperCut scissors	91	Micro needle holders	282-285, 770-772
uterine probes	670	Micro needle holders, DIADUST	289, 291, 293, 295-298, 759, 761, 763, 765-767, 769
MAYO-ADAMS , self-retaining retractors	465	DUROGRIP	287, 774
MAYO-HARRINGTON , dissecting scissors	84	Micro scalpel handles	44, 45
MAYO-HEGAR , needle holders	301, 302	Micro scalpels	24
MAYO-LEXER , dissecting scissors	85	Micro scissors	48-53, 55, 57-60, 747, 749, 768
DUROTIP dissecting scissors	95, 101	Micro suture tying forceps	139, 140, 143
NOIR dissecting scissors	105	Micro vein scissors	51
NOIR dissecting scissors, Wavecut	107	MICRO-ADSON , delicate dissecting forceps	151, 152
MAYO-NOBLE , dissecting scissors	84	delicate tissue forceps	168, 169
MAYO-ROBSON , ATRAUMATA intestinal clamps	555	dissecting and ligature forceps	244
intestinal clamps	555	MICRO-ADSON-BIEMER , delicate tissue forceps	168
MAYO-STILLE , dissecting scissors	82, 83	MICRO-HALSTED , hemostatic forceps	220
MC CLINTOCK , placenta- and ovum forceps	735	Microsurgical blades	45
MC CLURE , micro scissors	48	MIDDELDORPF , cheek retractors	406
MC GIVNEY , hemorrhoidal forceps	585	MIKULICZ , abdominal retractors	437, 438
MC INDOE , bone cutting forceps	1040	peritoneum forceps	257-259
delicate dissecting forceps	154	tonsil forceps	240
delicate tissue forceps	172	MILLER , bone rasps	979
fine retractors	361	MILLESİ , micro scissors	52
monopolar diathermy forceps	517	MILLIN , ATRAUMATA lobe grasping forceps	622
MC KENTY , raspatories	960	bladder neck spreaders	622
MC KENZIE , burrs	1052, 1053	bladder retractors	496, 617
perforators	1053	ligature holding forceps	326, 622
MC KISSOCK , raspatories	971	MILLS , cardiovascular scissors	111
MEAD , bone rongeurs	1029	gall duct scissors	597
mallets	992	Mills, hollow	1057
raspatories	966	MIOS, hip retractors	947-959
Measures, medical	1108	Mirrors, head	2
MEHDORN , clip applying forceps	210	laryngeal	5
vessel clips	210	rhinoscopic	5
Membrane puncturing forceps	722	MITCHELL , raspatories	973
Meniscus forceps	1043	MIXTER , dissecting and ligature forceps	253, 255, 841
Meniscus knives	1044	gall duct- and cystic forceps	593
Mercedes retractors	874	MIXTER-O'SHAUGNESSY , dissecting and ligature forceps	249
METZENBAUM , delicate dissecting scissors	62	MOD. BERLIN , endometrial biopsy curettes	698
dissecting scissors	87	MOD. MÜNCHEN , endometrial biopsy curettes	698
DUROTIP dissecting scissors	97, 98	MOD. USA , plaster spreaders	1087
DUROTIP dissecting scissors, Wavecut	102, 103	Modular handle	959
NOIR delicate dissecting scissors	105	MOLLISON , self-retaining retractors	464
NOIR dissecting scissors	105	MOLT , raspatories	966
NOIR dissecting scissors, Wavecut	107	Monopolar connecting cable	522
SuperCut scissors	91	Monopolar diathermy forceps	516-518, 520
MEYER , reposition forceps	1015	Monopolar scissors	515
MEYERDING , retractors	371, 416	MORRIS , ATRAUMATA aorta clamps	811
MICHEL , clip applying forceps	352	ATRAUMATA sigmoid anastomosis forceps	563
rhinoscopic mirrors	5	retractors	415
suture clips	352	MORSE , sternum retractors	872
MICHEL MODIF. , clip applying and removing forceps	352	Mounting frames, abdominal retractors	449
Micro dissecting scissors	53	Mouth gags	14, 15
Micro forceps	141, 142, 145, 147, 150, 753, 755, 757, 769	MOYNIHAN , gall duct forceps	592
Micro forceps, jeweler patterns	138		

Alphabetischer Index – Alphabetical Index

M – O

A – Z

	Page		Page
MOYNIHAN , gall duct probes	598	Needle holders, with scissors, DUROGRIP	311
hemostatic forceps	223, 239	Needles	327, 328
intestinal clamps	553	Needles, guide	353
Multi-purpose clamps, ATRAUMATA	791-793, 809, 810, 824, 825, 828, 833, 834	intestinal	278
MURPHY , head bands	2	ligature	329-336, 1056
retractors	391	pudendus block	721
MURPHY-LANE , luxation levers	945	sternal puncture	634, 855
MUSEUX , organ- and tissue grasping forceps	197	sub-mucosal resection	515
uterine tenaculum forceps	678, 683, 684	surgical	276-278
MÜHLING , bone shears	116	NEGUS , suction dissectors	1103
raspatories	969	tonsil forceps	240
MÜLLER , abdominal retractor	442	NELATON , directors	342
ATRAUMATA rectal anastomosis clamp	566	NELSON , lung grasping forceps	180, 838
ATRAUMATA vascular clips	214, 215, 784, 785	NELSON-METZENBAUM dissecting scissors	88
DUROGRIP needle holders	317, 568	DUROTIP dissecting scissors	97
DUROGRIP suture forceps	178	DUROTIP dissecting scissors, Wavecut	102, 103
fine retractors	361	NELSON-METZENBAUM (MC INDOE) ,	98
micro forceps	141, 142	DUROTIP dissecting scissors	
micro needle holders	285	Nerve approximators	212
micro scissors	55	Nerve dissecting scissors	63, 79
rectal scissors	127, 567	Nerve hooks	356-359
vessel clips	213	Nerve root retractors	376
Myoma screws	690	NIEDERDELLMANN osteotomes	1005
Myrtle leaf probes	344	NISSEN , dissecting and ligature forceps	245, 256
		gall duct- and cystic forceps	591
		hemostatic forceps	225
		NOIR dissecting scissors	105
		NOIR dissecting scissors, Wavecut	106, 107
		NORFOLK and NORWICH ,	468
		self-retaining laminectomy retractors	
N		NORTHBENT , ligature scissors	128
NABATOFF , vein stripper set	887	NORTHFIELD , bone rongeurs	1031
Nail cutters	12	NOTO , organ- and tissue grasping forceps	193
Nail extracting forceps	1079	polypus and ovum forceps	686
Nail files	13	sponge holding and dressing forceps	193
Nail scissors	11, 12, 130	NOVAK-SCHOECKAERT endometrial biopsy curettes	698
Nail splitting forceps	1079	NOYES , micro scissors	48
Nail splitting scissors	75, 1079	NUSSBAUM , intestinal clamps	553
Nasal dressing forceps	165-167	NÄGELE , obstetrical forceps	726
Nasal knives	32		
Nasal tampon forceps	184	O	
NAUNTON MORGAN , DUROGRIP needle holders	317	O'SHAUGNESSY , dissecting and ligature forceps	249, 252
rectal specula wit cold light	574	O'SULLIVAN-O'CONNOR abdominal retractors	489
Needle cases	279	Obstetric levers	730
Needle electrodes	509-512, 514	Obstetrical forceps	726-729
Needle holders	299-303, 305	OBWEGESER awls	1056
Needle holders with scissors	304	osteotomes	1005
Needle holders, boomerang	326, 623	retractors	401, 402
DIADUST	289, 291, 293, 295-298, 759, 761, 765-767, 769	OCHSNER , ATRAUMATA aorta clamps	817
DUROGRIP	286, 287, 307-310, 312-325, 568, 773-779	gall duct probes	599
micro	282-285, 287, 289, 291, 293, 295-298, 759, 761, 765-767, 769-772, 774	ligature forceps	158
with scissors	304	OFFICER , tissue forceps	176



Alphabetischer Index – Alphabetical Index

O – P

A – Z

	Page		Page
Offset scissors	111	PELKMANN , foreign body forceps	200
Oil, instruments	1112	gall stone forceps	604
OLDBERG , rongeurs	908	uterine dressing forceps	672
OLIVECRONA , bone rongeurs	1030	Pelvimeters	720
trigeminal knives	31	Pelvis retractors	440, 441, 578
wire saws	924	PENFIELD , dissectors	928, 929
OLLIER , retractors	394	Penis clamps	625
OMBREDANNE , mallets	996	PENNINGTON , hemostatic forceps	241
Organ grasping forceps	190, 192, 193, 197–199, 540, 543	intestinal grasping forceps	542
Organ grasping forceps, ATRAUMATA	191, 544, 545, 835–837	PENNYBACKER , bone rongeurs	1031
ORMROD-SCHMITT , ligature disc	1065	dissectors	929
Osteophyte chisels	962	raspatories	972
Osteotomes	998, 999, 1001–1005, 1007, 1008, 1010	rongeurs	903
Osteotomes, fishtail	1001	PERCY , amputation retractors	920
OVERHOLT , dissecting and ligature forceps	247	Perforators	1053
OVERHOLT-GEISSENDOERFER , dissecting and ligature forceps	246	Perineal retractors	577
OVERHOLT-MIXTER , dissecting and ligature forceps	246	Periosteum knives	29, 918
Ovum curettes	713	Peripheral vascular clamps, ATRAUMATA	805–807
Ovum forceps	685–688, 732–735	Peritoneum forceps	257–260
Ovum forceps, ATRAUMATA	687	PERKINS , self-retaining retractors	463
Ovum scoops	712	PERTHES , reamers	1055
O'CONNELL , dissectors	929	PERWITZSCHKY , salival scissors	68
O'SULLIVAN-O'CONNOR , abdominal retractors	489	Phalangeal knives	29, 918
		PHANEUF , hysterectomy forceps	260
		Phleb extractors	889
		Phlebo dissectors	889
		PICCOLO , cotton applicator	348
		Pick-up forceps	19
		Picks, tissue	363
		Pins	1063
		Pins, safty	207
		PIPER , obstetrical forceps	727
		PITHA , foreign body forceps	200, 626
		Placenta curettes	713
		Placenta forceps	732–735
		Placenta scoops	712
		Plaster breakers	1087
		Plaster knives	1082
		Plaster saws	1082
		Plaster scissors	134, 135, 1083, 1084
		Plaster shears	1085, 1086
		Plaster spreaders	1087
		Plastic scissors	77
		Plate electrodes	510
		PLESTER , self-retaining retractors	462
		suction cannula	1095
		Pliers, flat-nosed	1069, 1070
		wire bending	1069, 1071
		wire cutting	1072–1078
		wire extraction	1070, 1071
		POIRIER , tissue grasping forceps	196
		Polypus forceps	685–688
		Polypus forceps, ATRAUMATA	687
		POOL , suction cannula	1093

Alphabetischer Index – Alphabetical Index

P – R

A – Z

	Page		Page
Poplitea retractors	497	RAMSEY , dissecting forceps	158
Pot, ink	25	tissue forceps	177
POTTS , dissecting scissors	80	RANDALL , endometrial biopsy curettes	698
POTTS-DE MARTEL , cardiovascular scissors	111	kidney stone forceps	614-616
gall duct scissors	597	RANKIN , hemostatic forceps	224
vascular scissors	110	Raspatories	960-977
POTTS-DIETRICH , vascular scissors	108, 109, 751	Raspatories, rib	861-863
POTTS-SMITH , cardiovascular scissors	111	suction	1103
vascular scissors	114	Rasps, bone	978-980
POZZI , uterine tenaculum forceps	676	Razors	9
uterine tenaculum forceps	674	Reamers	1055, 1056
PRATT , organ- and tissue grasping forceps	198	RECAMIER , placenta- and ovum curettes	713
rectal specula	571	uterine curettes	708
uterine tenaculum forceps	680	Rectal anastomosis forceps, ATRAUMATA	566
Pressure clamps	273, 584, 612	Rectal probes	342, 343, 579
Pressure clamps, ATRAUMATA	272, 560, 612	Rectal retractors	573
PRICE THOMAS , bronchus forceps	845	Rectal scissors	125-127, 565, 567
Probes	344-347, 579	Rectal specula	570, 571, 573
Probes, double ended	346	Rectal specula, cold light	574
fistula	343, 579	Rectal spreaders	576
gall duct	598, 599	Retractor blades, VARIO	420
guiding	336-338	Rectum biopsy forceps	581, 582
myrtle leaf	344	REDON , guide needles	353
rectal	342, 343, 579	REILL , micro needle holders	284, 772
sinus	345	reposition forceps	1015
tendon passing	1048	tendon strippers	1046
uterine	670, 671	wire cutting pliers	1076
Proctoscopes	573, 575	REIN/KUPKA , DUROGRIP needle holders	321, 775
Profunda clamps, ATRAUMATA	798	REMINGTON-HOBBS , monopolar diathermy forceps	518
Prostate retractor	452, 620	Removing Hooks, I.U.D.	697
PROVIDENCE-HOSPITAL , hemostatic forceps	221	Reposition forceps	1014-1016
Pudendus block needles	721	Reposition tampers	1015
Punches, aorta	852	RESANO , ATRAUMATA sigmoid anastomosis forceps	564
bone	892-898	cartilage scissors	89
dermal	33	Resection knives	29, 918
Puncture needles, sternal	855	Resection needles, sub-mucosal	515
PUTTI , bone files	980	Retractor spine, self-retaining	476
Pylorus clamps	558	Retractors, mercedes	874
Pylorus spreaders	557	Retractors	366, 370-411, 413-419, 422, 423, 425, 427-434, 437-439, 443-446, 457, 569, 946, 1025
		Retractors, abdominal	437-439, 442-448, 482, 483, 485-495
		abdominal, fixation device	448
		abdominal, mounting frame	449
		amputation	920
		aorta valve	884
		atrium	882, 883
		bladder	496, 617
		bone	387, 388
		CARBOTRAC	412
		cheek	378, 405-407
		dura	360, 363
		femur	473
Q			
QUERVAIN elevators	931		
QUINBY , delicate scissors	67		
R			
R.N.O.H. , bone biopsy trephine	1057		
Racks, sterilizing	33, 919		
RAGNELL , delicate dissecting scissors	63		
retractors	379		
RAMPLEY , sponge holding and dressing forceps	190		



Alphabetischer Index – Alphabetical Index

R – S

A - Z

	Page		Page
Retractors, fine	360-363	ROEDER , towel clamps	203
hemi-laminectomy	469	ROLLET , skin hooks	360
hip	947-959	Rongeurs	899-912
knee	399, 400, 1045	Rongeurs, bone	1026-1037
laminectomy, self-retaining	468, 470, 471, 476, 478	rib	860
lid	458	synovectomy	1026
mammaria	876	ROSE , retractors	379
MIOS	947-959	ROSER-KÖNIG , mouth gags	15
nerve root	376	ROTUNDA , uterine irrigation catheters	717
pelvis	440, 441, 578	Round bowls	1108
poplitea	497	ROUX , retractors	381-383
prostate	452, 620	ROWBOTHAM , suction cannula	1101
scapula	426, 880	RUDD , hemorrhoidal ligators	585
self-retaining	456-467, 472, 473, 768	Rulers	7
self-retaining, iliaca	475	Rulers, x-ray	7
self-retaining, laminectomy	468-471, 476-478	RUMEL , dissecting and ligature forceps	251
skin	363, 473	RUMEL-BELMONT , tourniquets	851
spine, self-retaining	478-480	RUSKIN , bone rongeurs	1032
sternum	872, 873, 876	RUSKIN-LISTON , bone cutting forceps	1040
thoracic	864, 865, 874	RUSS. MODELL , tissue forceps	179
thyroid	472	RUST , amputation saws	921
tracheal	364-366	RYDEL-SEIFFER , tuning fork	6
treangle handle	367-369	RYDER, DIADUST needle holders	298, 767
urethral	452, 620	DUROGRIP needle holders	319, 320, 778, 779
vaginal	472, 473, 659	RÖTTGEN-RUSKIN , bone rongeurs	1032
vein	373-376		
REVERDIN , abdominal and intestinal spatula	450		
needles	328	S	
suture instruments - reverdin needles	327	Saddle hooks	369
REYNOLDS , dissecting scissors	80	SAENGER , placenta and ovum forceps	733
REYNOLDS-JAMESON , vascular scissors	63	Safty pins	207
Rhinoscopic mirrors	5	Salival scissors	68
Rib contractors	877	Salpingograph	715
Rib holding forceps	859	SAROT, DUROGRIP needle holders	309
Rib raspatories	861-863	hemostatic forceps	229
Rib rongeurs	860	intrathoracic artery forceps	238
Rib shears	857, 858	SATINSKY , anastomosis clamps	843
Rib spreaders	865-871, 877	ATRAUMATA pediatric clamp	821
RIBBON , spatulas, malleable	450	vascular scissors	115
RICARD , abdominal retractors	483	SATTERLEE , amputation saws	923
RICHARDSON , retractors	413, 414	SAUER , lid retractors	458
RICHARDSON-EASTMAN , retractors	413	SAUERBRUCH , pick up forceps	19
RICHERS , monopolar forceps	520	retractors	404, 425
Rings, ligature rubber	585	rib shears	857
RNTNE HOSPITAL , self-retaining retractors	463	SAUERBRUCH-CORYLLOS , bone rongeurs	860, 1037
ROBERTS , hemostatic forceps	238	SAUNDERS , I.U.D. removing hooks	697
raspatories	966	Saw blades	921, 922
ROBIN , towel clamps	204	Saws, amputation	922, 923
ROCHARD , abdominal retractors	448	finger ring	1079
fixation device for abdominal retractors	448	plaster	1082
mounting frame for abdominal retractors	449	wire	924
ROCHESTER-CARMALT , hemostatic forceps	237	Scalp flap forceps	731
ROCHESTER-OCHSNER , hemostatic forceps	235	Scalpel blades	42, 43
ROCHESTER-PEAN , hemostatic forceps	233		

Alphabetischer Index – Alphabetical Index

S

	Page		Page
Scalpel blades, microsurgical	45	Scissors, DUROTIP	92-100, 597
Scalpel handles	38-41, 618	DUROTIP ligature	104
Scalpel handles, micro	44, 45	DUROTIP Wavecut	101-103
Scalpels	26, 27	enucleation	77
Scalpels, disposable	22-24	episiotomy	124, 724
micro	24	eye	49
Scapula retractors	426, 880	gall bladder	596
SCHAEDEL , towel clamps	201	gall duct	597
SCHUDE , bone curettes	984	gynecology	117-121
SCHERBACK , vaginal specula	657	hysterectomy	120
SCHINK , skin grafting knives	34	hysterectomy, DUROTIP	100
SCHMELZ , gestation calculators	720	incision	75
SCHMID , mouth gags	14	ligature	60, 92, 128
vascular spatula	850	ligature, DUROTIP	101
vessel irrigation cannula	846	lower lateral	77
SCHMIEDEN , guiding probes	337	micro	48-53, 55, 57-60, 747, 749, 768
SCHMIEDEN-TAYLOR , dura scissors	112	monopolar	515
SCHNEIDER-SAUERBRUCH , raspatories	973	nail	11, 12, 130
SCHNIDT , hemostatic forceps	240	nail splitting	75, 1079
tonsil forceps	240	nerve dissecting	63, 79
SCHOEMAKER , colectomy clamps	554	NOIR	105-107
SCHOENBORN , wound and vein retractors	375	offset	111
SCHRÖDER , organ- and tissue grasping forceps	197, 199	parametrium	120, 121, 692, 693
uterine scoops	707	plaster	134, 135, 1083, 1084
uterine tenaculum forceps	676, 678, 679	plastic	77
SCHUBERT , biopsy forceps	699	rectal	125-127, 565, 567
SCHUHKNECHT , suction cannula	1097	salival	68
SCHULZE , salpingograph	715	strabismus	76
SCHUMACHER MOD. WAGNER , bone levers	943	SuperCut	90, 91
SCHUMACHER , biopsy forceps	701	surgical	71-75, 82
biopsy tips	705	surgical, DUROTIP	93, 101
bone levers	944	surgical, heavy patterns	122
sternum shears	855	tendon	78
umbilical cord scissors	123, 723	umbilical cord	123, 723
SCHWEDISCHES MODELL , dissecting forceps	157	uterine	99, 103, 117-120
Scissors, abdominal	122	vascular	63, 78, 108-115, 751
anatomy	68	vascular, DUROTIP	100
arteriotomy	80	vein	51
bandage	131-133, 1082	Wavecut	102
bipolar dissecting	530	Wavecut, DUROTIP	101
bowel	125	Wavecut, NOIR	106, 107
bulldog	76	wire cutting	129, 1073
cardiovascular	108-111, 114	wire cutting, DUROTIP	100, 102, 1072
cartilage	81, 89	Scoops, blood	453
cloth	132-135, 1082	gall stone	602
coronary	57-59	ovum	712
delicate	61, 63-70, 92	placenta	712
dissecting	77, 79, 80, 82-89, 618	secretion	626
dissecting, delicate	62, 63, 76, 78, 80, 81	uterine	707
dissecting, DUROTIP	94-99, 101-103	uterine secretion	697
dissecting, micro	53	SCOVILLE-HAVERFIELD	476
dissecting, NOIR	105-107	self-retaining laminectomy retractors	
dura	112	SCOVILLE-RICHTER , laminectomy retractors	477
		Screws, myoma	690



Alphabetischer Index – Alphabetical Index

S

A - Z

	Page		Page
SCUDDER , ATRAUMATA stomach clamps	557	SIMS , uterine scissors	99
SEBILEAU , elevators	931	vaginal specula	640
Secretion scoops	626, 697	SIMS-MAIER , sponge- and dressing forceps	188
SEDILLOT , raspatories	971, 973	SIMS-SIEBOLD , uterine scissors	120
SEGOND , hysterectomy forceps	265	Single use electrode handle	508
SEGOND-LANDAU , hysterectomy forceps	264	Single use scalpels	22-24
SEIDEL , vaginal specula	641	Sinus forceps	184
SEIDL , biopsy forceps	702	Sinus probes	345
SEIFFERT , probes	347	Skin grafting knives	34, 35
SELDIN , raspatories	966	Skin hooks	360-363
Self-retaining retractors	456-467, 469, 472, 768	Skin retractors	473
Self-retaining retractors, laminectomy spine	468, 470, 471, 476-478 478-480	SMILLIE , knee retractors	399, 1045
SELLHEIM , obstetric levers	730	meniscus knives	1044
SELLORS , rib spreaders and contractor	877	SMITH , bandage scissors	131
SELMAN , tissue forceps	179	SMITH-BUIE , rectal retractors	573
SEMB , bone holding forceps	1018	SMITH-PETERSEN , osteotome	1004
bone rongeurs	860, 1036	SOMER , uterine elevating forceps	689
dissecting and ligature forceps	840	SPACKMAN , uterine cannula	716
raspatories	975	Spatula	348, 369
rib holding forceps	859	Spatula, abdominal	435, 436, 450, 451
rib raspatories	862	bladder	496, 617
SEMKEN , delicate dissecting forceps	154	intestinal	435, 436, 450, 451
delicate tissue forceps	171	lung	422-426, 878, 879, 881
SEMM , abdominal retractors	491	malleable	450
vaginal specula	639	tongue	4, 348
SENN-MILLER , retractors	377	vascular	850
Sequestrum forceps	1017	Spatulas, vascular	849
SEUTIN , plaster scissors	134, 1084	Specula, rectal	570, 571, 573
SEWALL , elevators	963	rectal, cold light	574
SEYFFERT , vaginal specula	639	vaginal	636-658
Shears, bone	116	SPENCER , ligature scissors	128
plaster	1085, 1086	SPENCER-WELLS , hemostatic forceps	232
rib	857, 858	Spermatic cord fixation clamps	625
sternum	855, 856	Spermatic cord hooks	625
SIEBOLD , uterine scissors	119	Sphincteroscopes	572
Sigmoid anastomosis forceps	561-563	Spine retractors, self-retaining	476, 478-480
Sigmoid anastomosis forceps, ATRAUMATA	564	Splinter forceps	181
Sigmoidoscopes	575	Sponge forceps	10, 184-190, 192, 193
SILVER , skin grafting knives	35	Spongiosa gouges	1008-1010
SIMON , bone curettes	988	Spoons, ureter	691
fistula hooks	372	Spreaders, bladder neck	622
fistula knives	30	lamina	481
retractors	417	perineal	577
uterine scoops	707	plaster	1087
vaginal specula	655	pylorus	557
SIMPSON , obstetrical forceps	728	rectal	573, 576
uterine probes	671	rib	865-871, 877
SIMPSON-BRAUN , obstetrical forceps	727	SPURLING , rongeurs	902, 906
SIMS , DUROTIP uterine scissors, Wavecut	103	ST. BARTS , ear hooks	356
gynecology scissors	117, 118	rongeurs	900, 901
rectal specula	570, 571	ST. MARKS , pelvis retractors	440, 441, 578
uterine curettes	709	ST. MARKS MODIF. GIRONA , perineal retractors	577
uterine probes	670	ST. MARTIN , delicate tissue forceps	168
		STACKE , probes	347

Alphabetischer Index – Alphabetical Index

S – T

A – Z

	Page		Page
STAMM , bone cutting forceps	1038	Surgical scissors, heavy pattern	122
STANDARD , DUROGRIP dissecting forceps	164	Suture clips	352
STEINMANN , pins	1063	Suture forceps, DUROGRIP	163, 178
STELLBRINK , synovectomy-rongeurs	1026	Suture holding frame	621
STELZNER , rectal scissors	126, 565	Suture tying forceps	139, 143
Sterile scalpels	22-24	Suture tying forceps, micro	139, 140
STERILIT , instruments oil	1112	Swab holders	582
Sterilizing forceps	1109	SWEDISH , dissectors	929
Sterilizing racks	33, 919	SYME , ligature needles	334
Sternal puncture needles	634, 855	raspatories	966
STERNBERG , retractors	378	Synovectomy rongeurs	1026
Sternum chisels	856	SYPERT , bone rongeurs	1035
Sternum retractors	872, 873, 876	punches	895
Sternum shears	855, 856	rongeurs	912
STEVENS , delicate dissecting scissors	62, 78	Syringes, hemorrhoidal	587
vascular- and tendon scissors	78	SYSTRUNK , nail splitting scissors	75, 1079
STIEGLITZ , splinter forceps	181		
STILLE , bone rongeurs	1034	T	
chisels	1003	TAKAHASHI , rongeurs	901
dissecting scissors	85	Tampers	997
gouges	1003	Tampers, reposition	1015
kidney clamps	610	Tangential occlusion clamps, ATRAUMATA	801, 802
osteotomes	1003	TARNIER , obstetrical forceps	729
plaster shears	1086	TAYLOR , retractors	946
STILLE-AESCLAP , plaster shears	1085	TEALE , uterine tenaculum forceps	681, 682
STILLE-BARRAYA , tissue grasping forceps	543	Tendon double hooks	369
vascular- and tumor forceps	179	Tendon hooks	373
STILLE-RUSKIN , bone rongeurs	1034	Tendon interlacing forceps	194
Stitch-cutters	43	Tendon passing probes	1048
STOCKMANN , penis clamps	625	Tendon scissors	78
Stomach clamps, ATRAUMATA	557	Tendon seizing forceps	194, 195
Strainer for tissue	714, 1090	Tendon strippers	1046, 1047
STRANDELL-STILLE , tendon hooks	373	Tenotomes	27
STRASSBURGER MODELL , tissue forceps	178	THOMS-GAYLOR , biopsy forceps	699
STRATTE , DUROGRIP needle holders	315	Thoracic retractors	864, 865, 874
STRAUSS , penis clamps	625	THOREK , vascular scissors	114
Stripper, vein	887, 888	THORPE , corneal forceps	151
Strippers, endarterectomy	851	Thyroid retractors	472
tendon	1046, 1047	Tier, knot	339
STRUCK , rib spreader	865	Tighteners, wire	1065
STRULLY , vascular scissors	112, 113	Tips, biopsy	705
SUBRAMANIAN (MODIF.) , ATRAUMATA aorta clamps	816	TISCHLER , biopsy forceps	706
Suction adapter	1099	Tissue forceps	170, 173-179
Suction cannula	885, 886, 1091-1102, 1104, 1105	Tissue forceps, delicate	168, 169, 171, 172
Suction dissectors	1103	Tissue grasping forceps	190, 192, 193, 196-199, 538-540, 543
Suction dissectors, tonsil	1103	Tissue grasping forceps, ATRAUMATA	191, 544, 545, 835-837
Suction heads, vacuum extraction	725	Tissue pick	363
Suction hose	714, 1090	Tissue strainer	1090
Suction raspatories	1103	Titanium ligature clip	738, 740, 742, 744
Suction tubes, dissecting	1103	Tongue forceps	16
SuperCut scissors	90, 91	Tongue spatula	4, 348
Surgical needles	276-278		
Surgical scissors	71-75, 82		
Surgical scissors DUROTIP	93, 101		



Alphabetischer Index – Alphabetical Index

T - V

A - Z

	Page		Page
Tonsil forceps	240	U	
Tonsil knives	31	UCHIDA MODIF. BURKE , ureter spoons	691
Tonsil suction dissectors	1103	UFFENORDE , bone curettes	983
Tourniquet	851	ULRICH , fistula knives	30
Towel clamps	201-206	ULRICH-AESCULAP , sponge- and dressing forceps	186
Tracheal dilators	474	Ultra-light forceps, ATRAUMATA	159, 546, 781
Tracheal hooks	364	Umbilical cord clamps	724
Tracheal retractors	364-366	Umbilical cord scissors	123, 723
Traction bows	1060-1062	Umbilical dilators	724
Transformer	3	Universal trocars	634
TRAVERS , self-retaining retractors	467	Ureter forceps, ATRAUMATA	624
Trays, kidney	1108	Ureter spoon	691
TRELAT , raspatories	961	Urethral bougies and dilating sounds	629, 630
vaginal specula	638	Urethral retractor	452, 620
Trephines, bone biopsy	1057	Urethral tunnel clamps	254, 691
TREVES , tissue forceps	177	Urinary catheters	627
Trigeminal knives	31	US-ARMY , retractors	386
Trocars	634	Uterine cannulas	716, 717
Trocars, universal	634	Uterine curettes	708-711
TROELTSCH dissecting forceps, angular	167	Uterine depressors	671
TROTTER , bone rongeurs	1030	Uterine dilators	662-666
TROUSSEAU , tracheal dilators	474	Uterine dressing forceps	672, 673, 675
Tubing clamps	17, 18	Uterine elevating forceps	688, 689
TUDOR-EDWARDS , abdominal retractors	443	Uterine irrigation catheters	717
TUFFIER , abdominal and intestinal spatula	450	Uterine probes	670, 671
abdominal retractors	443	Uterine scissors	99, 103, 117-120
artery grasping forceps	196	Uterine scissors, DUROTIP	103
intestinal and tissue grasping forceps	196, 538	Uterine scoops	707
rib spreaders	866, 867	Uterine secretion scoops	697
Tumor forceps	179	Uterine tenaculum forceps	674, 676-678, 681-684
Tumor grasping forceps	909		
Tuning forks	6	V	
Tunnelling instruments	853	Vacuum curettes	714, 1090
TURNER , monopolar diathermy forceps	517	Vacuum extraction, suction heads	725
TURNER-WARWICK , abdominal retractors	492, 493	Vaginal clamps, ATRAUMATA	267
urethral sound	629	Vaginal retractors	472, 473, 659
TUTTLE , lung grasping forceps	180, 838	Vaginal specula	636-658
Twin clamps	556	VALLEIX , uterine probes	671
Twist drills	1054	VANNAS , micro scissors	48, 50, 52
Twisters, wire, DUROGRIP	312, 1067, 1068	VARADY , mini vein strippers sets	888
TÜBINGER MODELL , gall stone forceps	605	phleb extractors	889
retractors	417	VARIO, retractor system	420, 421
vaginal specula	655	Vascular clamps, ATRAUMATA	790-801, 803-834
TÄGER , bone levers	944	Vascular clips, ATRAUMATA	214, 215, 784, 785
TÖNNIS , dissecting scissors	81	Vascular dilators	847, 848
dura retractors	360	Vascular forceps	179
DUROGRIP, needle holders	322	Vascular prosthesis draw-in forceps	854
grooved director	929	Vascular scissors	63, 78, 108-115, 751
needle holders	305	Vascular scissors, DUROTIP	100
vascular spatula	850	Vascular spatulas	849, 850
TÖNNIS MODIF. , DUROGRIP, needle holders	322	Vein hooks	357
TÖNNIS-ADSON , dissecting scissors	80	Vein retractors	373-376
DUROTIP dissecting scissors	96		
DUROTIP dissecting scissors, Wavecut	102		



Alphabetischer Index – Alphabetical Index

Y - Z

	Page
Y	
YANKAUER, suction cannula	885, 1093, 1094
YASARGIL, micro scissors	52
rongeurs	908
suction and irrigation cannula	1104
YEOMAN, biopsy forceps for rectum	580
YOUNG, tongue forceps	16
YOUNG-HRYNTSCHAK, boomerang needle holders	326, 623
Z	
ZAUFAL-JANSEN, bone rongeurs	1032
ZENKER, dissecting and ligature forceps	254
retractors	427
ZIEGLER, head bands	2
head mirrors	2
ZIELKE, gouges for scoliosis operations	1008
ZOELLNER, suction cannula	1098, 1099
ZWEIFEL, DUROGRIP needle holders	323

Page

A - Z

Numerischer Index – Numerical Index

55 – BC

Art. Nr. Cat. No.	Seite Page	Art. Nr. Cat. No.	Seite Page	Art. Nr. Cat. No.	Seite Page	Art. Nr. Cat. No.	Seite Page
5518016	23	AC473R	5	BA402R	26	BB080R	41
5518032	22	AC474R	5	BA403R	26	BB084R	41
5518040	22	AC475R	5	BA407R	26	BB085R	41
5518059	22	AC476R	5	BA408R	26	BB087R	41
5518067	23	AC477R	5	BA409R	26	BB088R	41
5518075	23	AC478R	5	BA451R	26	BB089R	41
5518083	23	AC479R	5	BA501R	27	BB175R	39
5518091	23	AC480R	5	BA503R	27	BB176R	39, 618
5518105	22	AC481R	5	BA504R	27	BB177R	39, 618
		AC483C	5	BA506R	27	BB178R	39, 618
16600487	43	AC497R	5	BA507R	27	BB361R	45
16600495	42	AC498R	5	BA508R	27	BB362R	45
16600509	42			BA509R	27	BB363R	45
16600517	42	AD099R	25	BA514R	27	BB364R	45
16600525	42	AD110R	8	BA546R	27	BB365R	45
16600541	43	AD123R	8	BA563R	27	BB366R	45
16600550	43	AD125R	8	BA604R	30	BB367R	45
16600568	43	AD127R	8	BA605R	30	BB368R	45
16600576	43	AD129R	8	BA606R	30	BB369R	45
16600584	43			BA611R	30	BB500	43
16600592	43	AN379R	15	BA641R	31	BB510	42
16615492	42	AN380R	15	BA646R	31	BB511	42
16615514	43	AN381R	15	BA704R	25	BB512	42
16615522	43	AN705R	16	BA705	25	BB513	42
16616634	43	AN706	16	BA706R	34	BB515	42
		AN709R	16, 192, 241	BA708R	34	BB515-1	42
AA804R	7	AN710R	16, 192, 583, 595, 685	BA709R	34	BB515-C	42
AA805R	7	AN711R	16, 192, 583, 596	BA710R	34	BB518	43
AA806R	7	AN908R	17	BA711R	34	BB519	43
AA808R	7	AN909R	17	BA712R	35	BB520	43
AA809	7	AN910R	17	BA713R	35	BB521	43
AA821C	7	AN911R	18	BA714R	35	BB522	43
AA822C	7	AN912R	18	BA715R	35	BB523	43
AA826	7	AN913R	18	BA716R	35	BB524	43
AA845R	8			BA717R	35	BB525	43
AA846R	8	BA210	22	BA718R	35	BB536	43
AA847R	8	BA211	22	BA719R	35	BB540	42, 696
		BA212	22			BB542	42
AC402	2	BA215	22	BB046R	44		
AC413	2	BA218	22	BB048R	44	BC004R	61
AC414	2	BA219	23	BB052R	44	BC005R	61
AC415	2	BA220	23	BB053R	45	BC006R	61
AC416	2	BA221	23	BB054R	44	BC007R	61
AC421	2	BA222	23	BB057R	45	BC008R	62
AC440	3	BA223	23	BB060R	44	BC009R	62
AC461	3	BA224	23	BB068R	38	BC010R	62
AC462	3	BA244R	9	BB070R	40	BC011R	62
AC463	3	BA245R	9	BB071R	40	BC015R	63
AC464	3	BA311SU	24	BB073R	38, 40	BC017R	63
AC468R	5	BA323SU	24	BB074R	38	BC020R	62
AC469R	5	BA364	24	BB075R	38	BC021R	62
AC470R	5	BA365	24	BB077R	39	BC022R	62
AC471R	5	BA367	24	BB078R	40	BC023R	62
AC472R	5	BA401R	26	BB079R	40, 696	BC026R	63



Numerischer Index – Numerical Index

BC

Art. Nr. Cat. No.	Seite Page	Art. Nr. Cat. No.	Seite Page	Art. Nr. Cat. No.	Seite Page	Art. Nr. Cat. No.	Seite Page
BC027R	63	BC194R	78	BC275R	97	BC345R	74
BC029R	63	BC195R	78	BC275W	102	BC346R	74
BC030R	68	BC210R	92	BC275WB	107	BC374R	75
BC033R	68	BC211R	92	BC276R	97	BC403R	72
BC034R	68	BC211W	101	BC277R	97	BC404R	72
BC050R	67	BC224R	93	BC277W	102	BC411R	73
BC056R	12, 64	BC228R	93	BC279R	97	BC413R	73
BC057R	12, 64	BC231R	93	BC279W	102	BC414R	73
BC060R	64	BC231W	101	BC281R	97	BC415R	73
BC061R	64	BC234R	93	BC281W	102	BC416R	73
BC064R	64	BC242R	94	BC282R	97	BC417R	73
BC065R	64	BC243R	94	BC283B	105	BC421R	71
BC100R	64	BC245R	100, 597	BC283R	95	BC423R	71
BC101R	64	BC250R	94	BC283W	101	BC424R	71
BC106R	65	BC251R	94	BC283WB	107	BC425R	71
BC107R	65	BC252R	94	BC284B	105	BC426R	71
BC110R	65	BC253R	94	BC284R	95	BC427R	71
BC111R	65	BC253W	101	BC284W	101	BC428R	71
BC112R	65	BC256R	95	BC284WB	107	BC441R	74
BC113R	65	BC257B	105	BC285R	97	BC443R	74
BC117R	65	BC257R	95	BC287R	98	BC444R	74
BC130R	66	BC257W	102	BC287W	103	BC445R	74
BC131R	66	BC257WB	106	BC289R	98	BC464R	75
BC135R	66	BC258R	96	BC290R	99	BC474R	75
BC140R	66	BC259B	105	BC290W	103	BC496R	72
BC141R	66	BC259R	96	BC291R	99	BC497R	72
BC144R	66	BC259W	102	BC291W	103	BC503R	75
BC145R	66	BC259WB	106	BC292R	99	BC504R	75
BC153R	67	BC260R	98	BC293R	99	BC506R	75
BC154R	69	BC261B	105	BC294W	104	BC515R	108, 109, 751
BC156R	70	BC261R	98	BC295W	104	BC516R	108, 109, 751
BC157R	70	BC261W	103	BC296W	104	BC517R	108, 109, 751
BC160R	70	BC261WB	107	BC297W	104	BC518R	108, 109, 751
BC161R	70	BC262R	98	BC298W	104	BC519R	108, 109, 751
BC162R	76	BC263B	105	BC299R	99	BC521R	75, 1079
BC163R	76	BC263R	98	BC303R	72	BC522R	108, 109, 751
BC164R	76	BC263W	103	BC304R	72	BC523R	108, 109, 751
BC165R	76	BC263WB	107	BC313R	73	BC524R	108, 109, 751
BC166R	79	BC265B	105	BC314R	73	BC525R	108, 109, 751
BC168R	79	BC265R	98	BC315R	73	BC526R	108, 109, 751
BC170R	78	BC265W	103	BC316R	73	BC531R	108, 109, 751
BC171R	78	BC265WB	107	BC317R	73	BC532R	108, 109, 751
BC172R	78	BC266R	98	BC320R	71	BC533R	108, 109, 751
BC173R	78	BC267R	98	BC321R	71	BC534R	108, 109, 751
BC175R	79	BC267W	103	BC323R	71	BC535R	108, 109, 751
BC177R	79	BC270R	97	BC324R	71	BC544R	82
BC178R	80	BC271B	105	BC325R	71	BC545R	82
BC180R	80	BC271R	97	BC326R	71	BC547R	82
BC181R	80	BC271W	102	BC327R	71	BC551R	100
BC184R	81	BC271WB	107	BC328R	71	BC552R	100
BC186R	78	BC273R	96	BC330R	71	BC554R	82
BC187R	78	BC273W	102	BC341R	74	BC555R	82
BC188R	81	BC274R	97	BC343R	74	BC557R	82
BC189R	81	BC275B	105	BC344R	74	BC558R	94

Numerischer Index – Numerical Index

BC – BD

Art. Nr. Cat. No.	Seite Page	Art. Nr. Cat. No.	Seite Page	Art. Nr. Cat. No.	Seite Page	Art. Nr. Cat. No.	Seite Page
BC559R	94	BC628R	79	BC760R	119	BC980R	132, 1082
BC560R	84	BC629R	80	BC761R	119	BC981R	132, 1082
BC561R	84	BC630R	80	BC762R	120	BC983R	132, 1082
BC562R	83	BC631R	80	BC763R	120, 693	BC985R	132, 1082
BC563R	83	BC633R	81	BC764R	121, 692	BC987R	132, 1082
BC564R	83	BC634R	81	BC765R	120, 693	BC988R	132
BC565R	83	BC635R	81	BC766R	121, 692	BC989R	132
BC566R	84	BC636R	114	BC771R	122		
BC569R	84	BC640R	115	BC772R	122	BD023R	156
BC570R	82	BC641R	115	BC774R	122	BD025R	156
BC572R	82	BC642R	112, 596	BC776R	122	BD027R	156
BC573R	82	BC643R	114	BC796R	123, 723	BD029R	156
BC575R	82	BC644R	112	BC797R	123, 723	BD030R	156
BC576R	83	BC645R	113	BC801R	128	BD031R	156
BC577R	83	BC646R	111	BC802R	128	BD032R	156
BC578R	83	BC647R	110	BC803R	128	BD033R	156
BC579R	83	BC648R	110	BC805R	128	BD035R	157
BC580R	85	BC649R	110	BC815R	129, 1073	BD037R	157
BC581R	85	BC650R	111, 597	BC835R	131	BD043R	156
BC584R	86	BC651R	111, 597	BC838R	131	BD045R	156
BC585R	86	BC652R	111	BC846R	131	BD047R	156
BC587R	86	BC653R	110	BC847R	131	BD049R	156
BC588R	86	BC654R	110	BC848R	133	BD050R	156
BC589R	86	BC656R	110	BC849R	133	BD051R	156
BC590R	85	BC657R	110	BC860R	133	BD052R	156
BC591R	85	BC658R	114	BC861R	133	BD053R	156
BC592R	85	BC659R	114	BC862R	133	BD065R	157
BC595R	89	BC660R	112	BC863R	133	BD067R	157
BC597R	114	BC662R	110	BC876R	133	BD068R	157
BC600R	87	BC663R	110	BC881R	132, 1082	BD069R	157
BC601R	87	BC664R	110	BC885R	132, 1082	BD077R	157
BC602R	87	BC669R	111	BC888R	134	BD078R	158
BC603R	87	BC670R	111	BC890R	132	BD081R	155
BC604R	87	BC672R	81	BC900R	90	BD083R	158
BC605R	87	BC680R	87	BC901R	90	BD130R	158
BC606R	87	BC683R	87	BC911R	90	BD151R	162
BC607R	87	BC685R	530	BC915R	90	BD154R	162
BC608R	515	BC686R	530	BC916R	90	BD156R	162
BC611R	88	BC687R	530	BC917R	90	BD157R	162
BC612R	88	BC688R	530	BC920R	90	BD158R	162
BC613R	88	BC689R	530	BC921R	90	BD159R	162
BC614R	88	BC690R	530	BC924R	91	BD160R	164
BC615R	88	BC702R	118	BC925R	91	BD164R	164
BC616R	88	BC703R	118	BC930R	91	BD165R	164
BC617R	126, 565	BC704R	118	BC931R	91	BD166R	164
BC618R	88	BC708R	118	BC934R	91	BD168R	164
BC619R	88	BC715R	113, 618	BC935R-BC937R	91	BD171R	163, 543
BC620R	89	BC721R	117	BC970R	132, 1082	BD173R	163, 543
BC621R	125, 565	BC723R	117	BC971R	132, 1082	BD180R	163
BC622R	126, 565	BC731R	118	BC973R	132, 1082	BD181R	163
BC623R	126, 565	BC741R	117	BC975R	132, 1082	BD185R	178
BC624R	125	BC743R	117	BC977R	132, 1082	BD190R	149, 757
BC625R	88	BC746R	117	BC978R	132	BD191R	149, 757
BC627R	127, 567	BC748R	117	BC979R	132	BD192R	149, 757



Numerischer Index – Numerical Index

BD – BF

Art. Nr. Cat. No.	Seite Page	Art. Nr. Cat. No.	Seite Page	Art. Nr. Cat. No.	Seite Page	Art. Nr. Cat. No.	Seite Page
BD193R.....	149, 757	BD336R.....	139	BD602R.....	176	BD878R.....	165
BD194R.....	149, 757	BD337R.....	139	BD603R.....	176	BD879R.....	165
BD195R.....	149, 757	BD338R.....	139	BD604R.....	176	BD880R.....	165
BD196R.....	149, 757	BD340R.....	140	BD606R.....	176	BD883R.....	166
BD197R.....	149, 757	BD343R.....	138	BD607R.....	176	BD885R.....	166
BD198R.....	164	BD345R.....	138	BD608R.....	177	BD886R.....	166
BD210R.....	153	BD500R.....	171	BD609R.....	177	BD887R.....	166
BD213R.....	154	BD501R.....	171	BD610R.....	177	BD888R.....	166
BD215R.....	154	BD502R.....	171	BD611R.....	177	BD900R.....	167
BD216R.....	154	BD505R.....	139	BD651R.....	173	BD902R.....	167
BD217R.....	154	BD506R.....	169	BD660R.....	172	BD903R.....	167
BD220R.....	151	BD507R.....	169	BD661R.....	172	BD904R.....	167
BD222R.....	151	BD508R.....	169	BD662R.....	172	BD905R.....	167
BD223R.....	152	BD509R.....	168	BD663R.....	172	BD910R.....	167
BD224R.....	152	BD510R.....	168	BD664R.....	172	BD911R.....	167
BD225R.....	151	BD511R.....	168	BD665R.....	171	BD952R.....	181
BD226R.....	152	BD512R.....	168	BD666R.....	171	BD963R.....	181
BD228R.....	154	BD513R.....	169	BD667R.....	171	BD964R.....	181
BD229R.....	154	BD520R.....	169	BD668R.....	171	BD965R.....	181
BD230R.....	154	BD521R.....	169	BD669R.....	171	BD980R.....	181
BD231R.....	155	BD522R.....	169	BD670R.....	172	BD992R.....	181
BD232R.....	155	BD523R.....	169	BD671R.....	172	BD993R.....	181
BD236R.....	154	BD527R.....	174	BD672R.....	172	BD995R.....	181
BD238R.....	155	BD533R.....	174	BD678R.....	173		
BD239R.....	155	BD535R.....	174	BD679R.....	172	BF003R.....	184
BD240R.....	155	BD537R.....	174	BD690R.....	178	BF004R.....	184
BD243R.....	155	BD539R.....	174	BD692R.....	178	BF006R.....	184
BD246R.....	155	BD540R.....	174	BD693R.....	177	BF008R.....	184
BD247R.....	155	BD541R.....	174	BD700R.....	170	BF010R.....	184
BD250R.....	155, 783	BD542R.....	174	BD701R.....	170	BF016R.....	184
BD257R.....	155	BD543R.....	174	BD702R.....	170	BF021R.....	184
BD260R.....	140	BD547R.....	175	BD704R.....	177	BF027R.....	185
BD261R.....	140	BD549R.....	175	BD705R.....	178	BF032R.....	185
BD264R.....	140	BD552R.....	174	BD725R.....	179, 543	BF033R.....	185
BD268R.....	154	BD553R.....	174	BD726R.....	179, 543	BF040R.....	185
BD269R.....	154	BD555R.....	174	BD727R.....	179, 543	BF041R.....	185
BD301R.....	153	BD557R.....	174	BD735R.....	179	BF046R.....	10, 185
BD302R.....	153	BD559R.....	174	BD736R.....	179	BF047R.....	10, 185
BD303R.....	153	BD560R.....	174	BD750R.....	179	BF056R.....	187
BD304R.....	153	BD561R.....	174	BD755R.....	179	BF057R.....	187
BD305R.....	153	BD562R.....	174	BD760R.....	179	BF058R.....	187
BD311R.....	153	BD563R.....	174	BD801R.....	180, 838	BF059R.....	187
BD312R.....	153	BD564R.....	174	BD802R.....	180, 838	BF060R.....	10, 186
BD313R.....	153	BD575R.....	175	BD820R.....	180, 543	BF061R.....	10, 186
BD314R.....	153	BD577R.....	175	BD852R.....	519	BF062R.....	186
BD315R.....	153	BD579R.....	175	BD853R.....	519	BF063R.....	186
BD320R.....	153	BD580R.....	175	BD854R.....	519	BF065R.....	186
BD321R.....	153	BD581R.....	175	BD855R.....	519	BF070R.....	188
BD322R.....	153	BD587R.....	176	BD856R.....	519	BF071R.....	188
BD329R.....	138	BD589R.....	176	BD857R.....	519	BF076R.....	188
BD330R.....	138	BD591R.....	176	BD858R.....	519	BF077R.....	188
BD331R.....	138	BD597R.....	176	BD859R.....	519	BF078R.....	188
BD333R.....	138	BD598R.....	176	BD860R.....	519	BF091R.....	189
BD335R.....	138	BD600R.....	175	BD870R.....	165	BF092R.....	189

Numerischer Index – Numerical Index

BF – BH

Art. Nr. Cat. No.	Seite Page	Art. Nr. Cat. No.	Seite Page	Art. Nr. Cat. No.	Seite Page	Art. Nr. Cat. No.	Seite Page
BF098R	189	BF466R	205	BH154R	222	BH316R	231
BF112R	190	BF491R	207	BH155R	222	BH318R	231
BF113R	190	BF493R	207	BH160R	223	BH332R	232
BF116R	190	BF494R	207	BH161R	223	BH333R	232
BF118R	190			BH164R	224	BH334R	232
BF120R	190	BH011R	216, 786	BH165R	224	BH335R	232
BF121R	190	BH012R	216, 786	BH166R	224	BH336R	232
BF122R	190, 594	BH013R	216, 786	BH167R	224	BH337R	232
BF123R	190, 594	BH014R	216, 786	BH168R	225	BH338R	232
BF135R	193, 685, 734	BH015R	216, 786	BH170R	223	BH339R	232
BF136R	193	BH016R	216, 786	BH171R	223	BH353R	520
BF299R	196	BH017R	216, 786	BH176R	224	BH354R	520
BF300R	196, 538	BH018R	216, 786	BH177R	224	BH361R	232
BF301R	196, 538	BH020R	216, 786	BH178R	225	BH410R	17, 231
BF303R	194	BH021R	216, 786	BH183R	226	BH412R	232
BF306R	194	BH022R	216, 786	BH187R	226	BH413R	232
BF307R	194	BH023R	216, 786	BH191R	227	BH414R	232
BF309R	197, 678	BH026R	216, 786	BH193R	227	BH415R	232
BF310R	197, 678	BH027R	216, 786	BH196R	228	BH422R	232
BF311R	197, 678	BH030R	217, 787	BH197R	228	BH424R	232
BF315R	195	BH031R	217, 787	BH198R	225	BH425R	232
BF316R	195	BH032R	217, 787	BH199R	225, 245	BH442R	233
BF320R	195	BH034R	217, 787	BH200R	225	BH443R	233
BF324R	195	BH100R	220	BH201R	225	BH444R	233
BF325R	195	BH104R	220	BH202R	225	BH445R	233
BF326R	195	BH105R	220	BH203R	225	BH446R	233
BF401R	201	BH106R	221	BH205R	226	BH447R	233
BF407R	201	BH108R	220	BH206R	227	BH448R	233
BF408R	201	BH109R	220	BH207R	227	BH449R	233
BF410R	201	BH110R	220	BH209R	227, 250	BH450R	233
BF411R	201	BH111R	220	BH210R	226	BH451R	233
BF417R	202	BH114R	220	BH211R	226	BH456R	233
BF426R	203, 674	BH115R	220	BH212R	225	BH457R	233
BF431R	203	BH118R	220	BH213R	225	BH470R	234
BF432R	203	BH119R	220	BH214R	226	BH471R	234
BF433R	203	BH120R	220	BH215R	226	BH472R	234
BF436R	203	BH121R	220	BH216R	227	BH473R	234
BF437R	203	BH123R	222	BH217R	227	BH474R	234
BF439R	204	BH124R	223	BH224R	229	BH475R	234
BF440R	204	BH125R	223	BH225R	229	BH610R	235
BF442R	204	BH126R	223	BH226R	238	BH612R	235
BF443R	204	BH127R	223	BH227R	230	BH614R	235
BF444R	203	BH130R	221	BH228R	228	BH615R	235
BF448R	203	BH131R	221	BH229R	228	BH618R	235
BF450R	202, 543	BH134R	221	BH230R	230	BH619R	235
BF451R	202, 543	BH135R	221	BH231R	230	BH630R	235
BF452R	202, 543	BH139R	221	BH234R	229	BH631R	235
BF458R	206	BH140R	222	BH238R	228	BH642R	236
BF459R	206	BH141R	222	BH239R	228	BH643R	236
BF460R	205	BH143R	221	BH243R	520	BH644R	236
BF461R	205	BH144R	222	BH300R	231	BH645R	236
BF463R	205	BH145R	222	BH302R	231	BH646R	236
BF464R	205	BH150R	222	BH304R	231	BH647R	236
BF465R	205	BH151R	222	BH312R	231	BH648R	236



Numerischer Index – Numerical Index

BH – BL

Art. Nr. Cat. No.	Seite Page	Art. Nr. Cat. No.	Seite Page	Art. Nr. Cat. No.	Seite Page	Art. Nr. Cat. No.	Seite Page
BH649R	236	BJ024R	246	BJ131R	254	BJ582R	269
BH650R	236	BJ025R	246	BJ132R	254	BJ583R	269
BH651R	236	BJ026R	246	BJ300R	257	BJ584R	269
BH652R	236	BJ029R	252, 619	BJ304R	257	BJ585R	269
BH653R	236	BJ031R	246	BJ305R	257		
BH654R	236	BJ032R	246	BJ306R	257	BL058N	276
BH655R	236	BJ033R	246	BJ308R	257	BL059N	276
BH658R	236	BJ034R	246	BJ309R	258	BL060N	276
BH659R	236	BJ035R	246	BJ310R	258	BL061N	276
BH686R	531	BJ041R	251	BJ312R	258	BL062N	276
BH687R	531	BJ042R	251	BJ313R	259	BL063N	276
BH689R	531	BJ043R	251	BJ314R	259	BL064N	276
BH800R	237	BJ044R	251	BJ315R	259	BL065N	276
BH801R	237	BJ045R	251	BJ325R	260	BL066N	276
BH804R	237	BJ047R	254	BJ326R	260	BL067N	276
BH805R	237	BJ048R	254	BJ500R	260	BL068N	276
BH807R	237	BJ050R	249	BJ501R	260	BL069N	276
BH808R	237	BJ051R	250, 840	BJ506R	263	BL070N	276
BH812R	238	BJ052R	251, 840	BJ507R	263	BL071N	276
BH813R	238	BJ055R	253, 593, 841	BJ509R	264	BL072N	276
BH814R	238	BJ057R	252	BJ510R	265	BL073N	276
BH831R	239, 592	BJ058R	252	BJ511R	265	BL074N	276
BH833R	239, 592	BJ059R	252	BJ515R	264	BL075N	276
BH835R	239, 609	BJ060R	255, 590	BJ517R	260	BL076N	276
BH837R	239, 609	BJ061R	255, 841	BJ519R	260	BL098N	276
BH839R	239, 609	BJ062R	255, 841	BJ520R	261	BL099N	276
BH902R	241, 542	BJ067R	249	BJ521R	261	BL100N	276
BH906R	16, 192, 241	BJ068R	255	BJ522R	261	BL101N	276
BH908R	192, 241	BJ070R	253	BJ524R	261	BL102N	276
BH949R	240	BJ073R	255, 841	BJ526R	262	BL103N	276
BH951R	240	BJ075R	254, 691	BJ527R	262	BL104N	276
BH952R	240	BJ076R	254, 691	BJ528R	265	BL105N	276
BH957R	240	BJ080R	247	BJ529R	261	BL106N	276
BH959R	240	BJ081R	247	BJ530R	267	BL107N	276
BH961R	240	BJ082R	247	BJ531R	267	BL108N	276
BH963R	240	BJ083R	247	BJ532R	267	BL109N	276
BH965R	240	BJ086R	247	BJ534R	266	BL110N	276
		BJ090R	247	BJ535R	266	BL111N	276
BJ002R	244	BJ091R	247	BJ536R	260	BL112N	276
BJ008R	244	BJ096R	247	BJ537R	266	BL113N	276
BJ009R	244	BJ100R	248	BJ540R	264	BL114N	276
BJ011R	244	BJ102R	248	BJ541R	265	BL115N	276
BJ012R	244	BJ103R	248	BJ550R	268	BL116N	276
BJ013R	245	BJ104R	248	BJ551R	100, 268	BL161N	276
BJ014R	245	BJ106R	248	BJ552R	100, 268	BL162N	276
BJ015R	245	BJ110R	252, 619	BJ553R	268	BL163N	276
BJ016R	245	BJ111R	247	BJ560R	271, 692	BL164N	276
BJ017R	245	BJ114R	247	BJ561R	271, 693	BL165N	276
BJ018R	245	BJ120R	252	BJ562R	271, 692	BL166N	276
BJ019R	246	BJ121R	252	BJ563R	271, 693	BL167N	276
BJ020R	246	BJ122R	252	BJ574R	270, 611	BL168N	276
BJ021R	246	BJ123R	252	BJ576R	270	BL169N	276
BJ022R	246	BJ124R	252	BJ579R	273, 612	BL170N	276
BJ023R	246	BJ130R	254	BJ581R	272, 612, 808	BL171N	276

Numerischer Index – Numerical Index

BL – BM

Art. Nr. Cat. No.	Seite Page	Art. Nr. Cat. No.	Seite Page	Art. Nr. Cat. No.	Seite Page	Art. Nr. Cat. No.	Seite Page
BL172N	276	BL546N	278	BM035R	313, 776	BM150R	325
BL173N	276	BL547N	278	BM036R	313, 776	BM151R	325
BL174N	276	BL548N	278	BM037R	313, 776	BM153R	325
BL175N	276	BL601N	278	BM038R	313, 776	BM154R	325
BL176N	276	BL602N	278	BM040R	314, 777	BM156R	325
BL201N	276	BL603N	278	BM042R	316	BM158R	325
BL202N	276	BL604N	278	BM044R	320, 779	BM165R	324
BL203N	276	BL605N	278	BM045R	320, 779	BM168R	324
BL204N	276	BL611N	278	BM046R	320, 779	BM170R	323
BL205N	276	BL612N	278	BM047R	320, 779	BM172R	323
BL206N	276	BL613N	278	BM051R	314, 777	BM178R	323
BL207N	276	BL614N	278	BM052R	314, 777	BM183R	322
BL208N	276	BL615N	278	BM054R	320, 779	BM184R	319, 778
BL209N	276	BL907R	279	BM055R	320, 779	BM186R	322
BL210N	276	BL910R	279	BM056R	320, 779	BM191R	322
BL211N	276	BL911R	279	BM057R	320, 779	BM193R	322
BL212N	276	BL915R	279	BM058R	320, 779	BM196R	322
BL213N	276	BL929R	279	BM063R	313, 776	BM200R	299
BL214N	276	BL930R	279	BM064R	313, 776	BM201R	299
BL215N	276	BL931R	279	BM065R	310	BM202R	299
BL216N	276	BL932R	279	BM066R	310	BM204R	299
BL231N	277	BL933R	279	BM067R	310	BM205R	299
BL232N	277	BL941R	279	BM068R	310	BM210R	299
BL233N	277	BL943R	279	BM069R	310	BM211R	300
BL234N	277			BM070R	310	BM215R	299
BL235N	277	BM001R	286, 773	BM074R	319, 778	BM218R	300
BL236N	277	BM002R	286, 773	BM075R	319, 778	BM219R	300
BL237N	277	BM003R	286, 773	BM076R	319, 778	BM220R	300
BL251N	277	BM004R	287, 774	BM077R	310	BM221R	301
BL252N	277	BM005R	287, 774	BM078R	310	BM224R	301
BL253N	277	BM008R	307	BM081R	315	BM235R	301
BL254N	277	BM009R	307	BM082R	315	BM236R	301
BL255N	277	BM010R	307	BM084R	315	BM237R	301
BL256N	277	BM011R	307	BM088R	317	BM238R	301
BL257N	277	BM012R	308	BM089R	317, 568	BM240R	301
BL301N	277	BM013R	309	BM090R	318	BM241R	302
BL302N	277	BM014R	308	BM092R	318	BM242R	302
BL303N	277	BM015R	308	BM095R	315	BM245R	302
BL305N	277	BM016R	309	BM096R	315	BM247R	302
BL318N	277	BM017R	309	BM100R	315	BM249R	302
BL319N	277	BM018R	308	BM101R	315	BM255R	302
BL320N	277	BM019R	309	BM102R	315	BM259R	302
BL321N	277	BM020R	309	BM105R	316	BM270R	302
BL322N	277	BM021R	309	BM110R	312, 1067	BM272R	303
BL323N	277	BM022R	309	BM111R	312, 1067	BM275R	303
BL324N	277	BM023R	309	BM112R	312, 1067	BM280R	303
BL325N	277	BM024R	308	BM113R	312, 1068	BM290R	304
BL539N	278	BM025R	313, 776	BM124R	311	BM291R	304
BL540N	278	BM026R	313, 776	BM127R	311	BM298R	304
BL541N	278	BM027R	313, 776	BM128R	311	BM299R	304
BL542N	278	BM030R	309	BM129R	311	BM301R	298, 767
BL543N	278	BM032R	313, 776	BM132R	324	BM302R	298, 767
BL544N	278	BM033R	313, 776	BM148R	325	BM310R	321, 775
BL545N	278	BM034R	313, 776	BM149R	325	BM311R	321, 775



Numerischer Index – Numerical Index

BM – BT

Art. Nr. Cat. No.	Seite Page	Art. Nr. Cat. No.	Seite Page	Art. Nr. Cat. No.	Seite Page	Art. Nr. Cat. No.	Seite Page
BM320R	321, 775	BM856R	334	BN120R	345	BN925R	353
BM325R	298, 767	BM858R	335	BN125R	345	BN926R	353
BM327R	298, 767	BM861R	335, 1056	BN134R	345	BN942R	353
BM328R	298, 767	BM900R	337	BN136R	345	BN943R	353
BM360R	305	BM901R	337	BN138R	345	BN944R	353
BM361R	305	BM902R	337	BN140R	345	BN945R	353
BM362R	305	BM905R	337	BN150R	345	BN946R	353
BM406R	305	BM911R	337	BN160	347	BN947R	353
BM407R	305	BM913R	337	BN161	347		
BM503R	305	BM920R	337	BN170R	347	BT001R	378
BM510R	305	BM922R	337	BN172R	347	BT004R	379
BM560R	283, 771	BM924R	338	BN184R	348	BT005R	377
BM562R	283, 771	BM925R	338	BN400R	349	BT006R	377
BM563R	282, 770	BM931R	336	BN403	349	BT007R	377
BM564R	282, 770	BM932R	336	BN404	349	BT008R	377
BM620R	326, 623	BM938	338	BN440R	349	BT010R	379
BM627R	326, 623	BM940	338	BN445R	349	BT011R	379
BM628R	326, 623	BM941	338	BN452R	351	BT012R	379
BM629R	326, 623	BM950R	339	BN457R	351	BT019R	379
BM711R	327	BM976R	691	BN460R	350	BT020R	379
BM712R	327	BM977R	691	BN461R	350	BT021R	379
BM713R	327			BN465R	350	BT022R	380
BM714R	327	BN003R	342	BN466R	350	BT025R	379
BM726R	328	BN004R	342	BN467R	349	BT026R	380
BM727R	328	BN006R	342	BN468R	350	BT028R	382
BM728R	328	BN010R	342	BN507R	352	BT029R	382
BM729R	328	BN012R	342	BN511R	352	BT030R	381
BM748R	333	BN015R	342	BN512R	352	BT031R	381
BM749R	333	BN020R	342, 579	BN515R	352	BT032R	381
BM755R	333	BN021R	343, 579	BN516R	352	BT033R	381
BM770R	332	BN022R	343, 579	BN518R	352	BT034R	383
BM771R	332	BN023R	343, 579	BN520R	352	BT035R	383
BM774R	333	BN024R	343, 579	BN522R	352	BT036R	383
BM780R	332	BN026R	343, 579	BN730R	352	BT037R	384
BM781R	332	BN034R	344, 1048	BN731R	352	BT038R	384
BM801R	329	BN036R	344, 1048	BN750R	352	BT040R	385
BM802R	329	BN040R	344, 1048	BN754R	352	BT041R	386
BM806R	330	BN054R	344	BN757R	352	BT042R	384
BM807R	330	BN063R	344	BN758R	352	BT047R	386
BM808R	330	BN064R	344	BN902R	353	BT048R	386
BM809R	330	BN066R	344	BN903R	353	BT049R	386
BM810R	331	BN068R	344	BN904R	353	BT075R	357
BM811R	331	BN070R	344	BN905R	353	BT080R	357
BM812R	329	BN090R	345, 579	BN906R	353	BT082R	357
BM813R	329	BN095	346	BN907R	353	BT083R	357
BM814R	329	BN096	346	BN912R	353	BT084R	359
BM822R	331	BN099	346	BN913R	353	BT088R	359
BM823R	331	BN101R	346	BN914R	353	BT089R	359
BM824R	331	BN104R	345	BN915R	353	BT090R	359
BM825R	331	BN110	345	BN916R	353	BT091R	359
BM831R	336, 1056	BN113R	345	BN917R	353	BT100R	364
BM832R	336	BN114R	345	BN922R	353	BT103R	364
BM853R	334	BN116R	345	BN923R	353	BT106R	364
BM855R	334	BN118R	345	BN924R	353	BT107R	364

Numerischer Index – Numerical Index

BT

Art. Nr. Cat. No.	Seite Page	Art. Nr. Cat. No.	Seite Page	Art. Nr. Cat. No.	Seite Page	Art. Nr. Cat. No.	Seite Page
BT111R	365	BT223R	388	BT322R	395	BT462R	409
BT112R	365	BT224R	388	BT323R	395	BT463R	409
BT113R	365	BT225R	388	BT325R	395	BT464R	407
BT114R	365	BT227R	388	BT326R	395	BT465R	408
BT116R	365	BT228R	388	BT327R	397	BT470R	413
BT117R	365	BT229R	388	BT328R	397	BT471R	413
BT118R	365	BT230R	388	BT329R	415	BT472R	413
BT119R	365	BT232R	387	BT330R	415	BT475R	413
BT121R	366	BT234R	387	BT331R	415	BT476R	413
BT122R	366	BT238R	387	BT332R	398	BT477R	413
BT123R	366	BT239R	387	BT340R	397	BT478R	414
BT124R	366	BT240R	387	BT343R	398	BT479R	414
BT126R	366, 625	BT241R	387	BT351R	404	BT481R	415
BT127R	366	BT242R	389	BT352R	404	BT482R	415
BT128R	366	BT243R	389	BT353R	404	BT483R	415
BT129R	366	BT244R	389	BT354R	396	BT484R	415
BT132R	365	BT246R	389	BT356R	396	BT485R	416
BT133R	365	BT248R	389	BT357R	396	BT486R	416
BT134R	365	BT252R	389	BT358R	396	BT487R	416
BT136R	365	BT253R	389	BT359R	396	BT490R	410
BT137R	365	BT254R	389	BT361R	396	BT492R	410
BT138R	365	BT256R	389	BT363R	396	BT494R	410
BT161R	372	BT257R	389	BT364R	396	BT498R	410
BT166R	372	BT258R	389	BT365R	396	BT500R	443
BT167R	372	BT259R	389	BT369R	403	BT501R	946
BT170R	373	BT260R	389	BT370R	403	BT502R	946
BT171R	373	BT261R	389	BT371R	403	BT503R	946
BT172R	373	BT262R	390	BT372R	403	BT504R	946
BT173R	370	BT263R	390	BT373R	403	BT505R	946
BT174R	370	BT264R	390	BT400R	405	BT508R	418
BT177R	370	BT265R	389	BT404R	406	BT509R	418
BT178R	370	BT266R	390	BT405R	406	BT510R	418
BT179R	370	BT272R	390	BT406R	406	BT511R	418
BT180R	373	BT273R	390	BT408R	406	BT512R	418
BT181R	373	BT274R	390	BT419R	400, 1045	BT513R	418
BT182R	374	BT276R	390	BT420R	400, 1045	BT514R	425
BT183R	374	BT278R	392	BT421R	399, 1045	BT521R	425
BT184R	375	BT279R	392	BT422R	399, 1045	BT522R	425
BT185R	375	BT280R	392	BT423R	399, 1045	BT523R	425
BT187R	375	BT284R	393	BT424R	399, 1045	BT524R	419
BT190R	374	BT285R	393	BT425R	399, 1045	BT525R	419
BT192R	375	BT286R	393	BT430R	400, 1045	BT526R	419
BT193R	371	BT287R	393	BT440R	411	BT527R	419
BT194R	371	BT288R	394	BT441R	411	BT528R	419
BT195R	371	BT290R	392	BT442R	411	BT529R	419
BT196R	371	BT293R	391	BT443R	411	BT530R	419
BT197R	371	BT294R	391	BT444R	411	BT531R	426, 880
BT198R	371	BT295R	391	BT445R	411	BT540P	412
BT200R	376	BT296R	391	BT446R	411, 569	BT542P	412
BT201R	376	BT311R	394	BT457R	374	BT545P	412
BT202R	376	BT315R	394	BT458R	374	BT551R	422, 878
BT206R	376	BT316R	394	BT459R	409	BT552R	422, 878
BT221R	388	BT320R	395	BT460R	409	BT553R	423, 879
BT222R	388	BT321R	395	BT461R	409	BT559R	424, 881



Numerischer Index – Numerical Index

BT – BV

Art. Nr. Cat. No.	Seite Page	Art. Nr. Cat. No.	Seite Page	Art. Nr. Cat. No.	Seite Page	Art. Nr. Cat. No.	Seite Page
BT560R	424, 881	BT732R	435	BT916R	367	BV086R	472
BT561R	424, 881	BT740R	436	BT917R	367	BV087R	472, 659
BT594R	427	BT742R	436	BT918R	367	BV088R	464
BT595R	427	BT746R	451	BT921R	367	BV090R	462
BT596R	427	BT747R	451	BT922R	367	BV091R	462
BT597R	427	BT749R	450	BT923R	367	BV092R	464
BT600R	429	BT750R	450	BT926R	367	BV093R	464
BT601R	429	BT751R	450	BT927R	367	BV094R	463
BT602R	430	BT752R	450	BT928R	367	BV097R	461
BT603R	430	BT755R	450	BT933R	368	BV098R	461
BT604R	431	BT756R	450	BT940R	368	BV099R	461
BT605R	432	BT758R	450	BT943R	368	BV101R	460
BT606R	429	BT761R	450	BT944R	368	BV104R	460
BT607R	431	BT762R	450	BT945R	368	BV112R	465
BT608R	432	BT763R	450	BT946R	368	BV113R	465
BT611R	433	BT773R	451	BT948R	369	BV199R	466
BT613R	433	BT774R	451	BT949R	369	BV200R	466
BT614R	434	BT775R	451	BT951R	369	BV201R	466
BT615R	434	BT776R	451	BT958R	369	BV203R	466
BT617R	443	BT777R	451	BT964R	369	BV205R	466
BT618R	437	BT780R	453	BT966R	369	BV206R	466
BT621R	437	BT795R	453			BV207R	466
BT622R	438	BT799R	421	BV001R	456	BV208R	466
BT623R	438	BT800R	421	BV002R	456	BV209R	466
BT624R	438	BT801R	420	BV003R	456	BV247R	467
BT626R	442	BT802R	420	BV005R	456	BV248R	468
BT630R	439	BT803R	420	BV006R	456	BV249R	467
BT633R	439	BT804R	420	BV007R	456	BV250R	468
BT655R	445	BT805R	420	BV008R	457	BV252R	468
BT656R	445	BT806R	420	BV010R	457	BV254R	469
BT657R	445	BT807R	420	BV011R	457	BV255R	469
BT658R	445	BT808R	420	BV013R	457	BV258R	470
BT659R	445	BT809R	420	BV014R	457	BV260R	469
BT667R	446	BT810R	420	BV015R	457	BV271R	470
BT669R	446	BT811R	420	BV028R	458	BV272R	470
BT670R	440, 578	BT812R	420	BV030R	458	BV273R	471
BT672R	440, 578	BT813R	420	BV032R	458	BV276R	471
BT674R	441, 578	BT814R	420	BV033R	458	BV296R	481
BT680R	452, 620	BT815R	420	BV059R	768	BV297R	481
BT681R	452, 620	BT816R	420	BV066R	459	BV298R	481
BT703R	447	BT817R	420	BV067R	459	BV299R	481
BT708R	449	BT818R	420	BV068R	461	BV326R	482
BT709R	449	BT819R	420	BV070R	459	BV327R	482, 497
BT710R	448	BT820R	420	BV071R	459	BV328R	482
BT711R	448	BT821R	420	BV072R	461	BV329R	482
BT712R	448	BT822R	420	BV073R	459	BV338R	482
BT713R	448	BT901R	367	BV074R	459	BV348R	497
BT714R	448	BT902R	367	BV075R	461	BV349R	497
BT715R	448	BT904R	367	BV076R	460	BV361R	482
BT721R	447	BT906R	367	BV077R	460	BV362R	482
BT723R	447	BT908R	367	BV078R	462	BV363R	482
BT724R	447	BT911R	367	BV079R	462	BV366R	483
BT725R	447	BT912R	367	BV084R	463	BV367R	483
BT730R	435	BT913R	367	BV085R	463	BV369R	483

Numerischer Index – Numerical Index

BV – DO

Art. Nr. Cat. No.	Seite Page	Art. Nr. Cat. No.	Seite Page	Art. Nr. Cat. No.	Seite Page	Art. Nr. Cat. No.	Seite Page
BV379R	480	BV505R	485	BV616R	487	BV697R	492, 493
BV380R	480	BV506R	485	BV617R	487	BV698R	492, 493
BV381R	480	BV509R	477	BV618R	487	BV709R	475
BV382R	480	BV510R	477	BV621R	488	BV710R	475
BV383R	480	BV512R	485, 866	BV622R	488	BV711R	475
BV384R	480	BV516R	477	BV624R	488	BV712T	475
BV385R	480	BV517R	477	BV626R	488	BV713T	475
BV391R	480	BV518R	477	BV628R	488	BV906R	573
BV392R	480	BV519R	477	BV632R	488	BV907R	577
BV393R	480	BV520R	482	BV634R	488	BV927R	621
BV394R	480	BV522R	482	BV636R	488	BV928R	496, 617
BV395R	480	BV523R	482	BV638R	488	BV993R	472
BV400R	476	BV524R	482	BV640R	488	BV996R	473, 659
BV401R	476	BV527R	483	BV645R	490	BV997R	473, 659
BV403R	476	BV528R	483	BV646R	490	BV998R	473
BV405R	476	BV530R	482	BV647R	490	BV999R	473
BV406R	476	BV531R	482	BV648R	490		
BV409R	476	BV532R	482	BV649R	490	DF112R	993
BV411R	476	BV533R	482	BV650R	490	DF114R	993
BV413R	479	BV535R	482	BV653R	491		
BV414R	479	BV536R	482	BV654R	491	DO208R	92
BV415R	479	BV542R	483	BV655R	491	DO209R	92
BV416R	479	BV543R	483	BV656R	491	DO210R	65
BV417R	479	BV545R	483	BV657R	491	DO211R	65
BV435R	478	BV551R	482, 484	BV658R	491	DO218R	67
BV437R	478	BV552R	482, 484	BV659R	491	DO219R	69
BV441R	478	BV553R	482, 484	BV660R	494	DO250R	92
BV442R	478	BV554R	482, 484	BV661R	494	DO251R	69
BV443R	478	BV555R	482, 484	BV662R	494	DO252R	69
BV444R	478	BV556R	483, 484	BV663R	494	DO432R	407
BV445R	478	BV557R	483, 484	BV664R	494	DO438R	408
BV446R	478	BV558R	483, 484	BV665R	494	DO439R	408
BV447R	478	BV575R	496, 617	BV668R	494	DO440R	405
BV448R	478	BV576R	496, 617	BV669R	494	DO441R	405
BV449R	478, 479	BV577R	496, 617	BV670R	495	DO450R	401
BV450R	478	BV578R	496, 617	BV672R	495	DO451R	401
BV451R	478	BV580R	496, 617	BV674R	495	DO452R	401
BV452R	478	BV581R	576	BV675R	495	DO453R	401
BV453R	478	BV582R	576	BV676R	495	DO454R	401
BV454R	478	BV583R	576	BV680R	495	DO455R	401
BV455R	478	BV584R	576	BV682R	495	DO460R	402
BV456R	478	BV585R	576	BV684R	495	DO461R	402
BV457R	478	BV586R	576	BV685	492	DO462R	402
BV458R	478	BV589R	576	BV686R	492	DO463R	402
BV461R	478	BV591R	576	BV687R	492	DO464R	402
BV462R	478	BV601R	485	BV688R	492	DO465R	402
BV463R	478	BV602R	485	BV689R	492	DO510R	961
BV464R	478	BV605R	486	BV690R	492, 493	DO518R	972
BV465R	478	BV606R	486, 488	BV691R	492, 493	DO520R	966
BV466R	478	BV608R	486	BV692R	492, 493	DO523R	969
BV467R	478	BV609R	486, 488	BV693R	492, 493	DO543R	966
BV468R	478	BV610R	486	BV694R	492, 493	DO546R	961
BV500R	485	BV611R	486, 488	BV695R	492, 493	DO547R	966
BV502R	485	BV615R	487	BV696R	492, 493	DO548R	966



Numerischer Index – Numerical Index

DO – EB

Art. Nr. Cat. No.	Seite Page	Art. Nr. Cat. No.	Seite Page	Art. Nr. Cat. No.	Seite Page	Art. Nr. Cat. No.	Seite Page
DO552R	966	DP552R	100, 1072	EA140R	549	EA825R	571
DO553R	966	DP560R	129	EA141R	549	EA826R	571
DO608R	982	DP561R	129	EA145R	549	EA828R	571
DO609R	982	DP563R	129	EA146R	549	EA829R	571
DO611R	960	DP569R	129	EA150R	551	EA831R	571
DO612R	960			EA151R	551	EA843R	571
DO630R	983	EA010R	196, 538	EA152R	551	EA853R	573
DO631R	983	EA012R	196, 538	EA155R	551	EA862C	572
DO632R	983	EA013R	539	EA156R	551	EA863C	572
DO633R	983	EA014R	539	EA157R	551	EA864C	572
DO642R	960	EA015R	539	EA170R	555	EA871R	574
DO650R	982	EA016R	196, 539	EA171R	555	EA873R	574
DO651R	982	EA017R	539	EA176R	553	EA875R	574
DO655R	982	EA018R	539	EA182R	553	EA876R	574
DO656R	982	EA020R	540	EA191R	561	EA877R	575
DO670R	982	EA025R	540	EA202R	552	EA878R	575
DO671R	982	EA026R	540	EA203R	552	EA879R	575
DO672R	982	EA027R	180, 543	EA204R	552	EA880R	572
DO673R	982	EA028R	543, 838	EA205R	552	EA882R	572
DO674R	982	EA030R	540	EA206R	552	EA883R	572
DO711R	1001	EA031R	540, 839	EA207R	552	EA887R	573
DO713R	1001	EA032R	540, 839	EA210R	548	EA888R	575
DO715R	1001	EA033R	540	EA211R	548	EA889R	575
DO717R	1001	EA036R	541	EA212R	550	EA890R	579
DO720R	1005	EA037R	241, 542	EA213R	550	EA900R	580
DO722R	1002	EA039R	541	EA216R	555	EA903R	580
DO723R	1002	EA040R	541	EA217R	555	EA904R	581
DO725R	1002	EA041R	541	EA220R	547	EA905R	582
DO726R	1002	EA042R	541	EA221R	547	EA906R	582
DO728R	1005	EA050R	544, 835	EA222R	548	EA907R	582
DO730R	1005	EA052R	544, 835	EA223R	548	EA912R	581, 704
DO732R	1002	EA061R	191, 544, 837	EA240R	557	EA914R	581
DO733R	1002	EA062R	191, 544, 837	EA305R	558	EA943R	582
DO750R	1007	EA092R	544, 836	EA306R	558	EA989R	583
DO751R	1007	EA095R	544, 836	EA309R	558	EA990R	585
DO752R	1007	EA096R	544, 836	EA321R	554	EA991R	585
DO753R	1007	EA097R	544, 836	EA331R	559	EA993	585
DO754R	1007	EA099R	544, 836	EA332R	559	EA996R	586
DO755R	1007	EA100R	544, 568, 836	EA334R	559	EA997R	586
DO771R	979	EA101R	544, 836	EA336R	559	EA998R	586
DO772R	979	EA106R	547	EA338R	559	EA999P	586
DO773R	979	EA107R	547	EA355R	564		
DO811R	1056	EA114R	547	EA356R	566	EB001R	255, 590
DO812R	1056	EA116R	547	EA360R	564	EB003R	255, 590
		EA117R	547	EA362R	562	EB008R	256, 591
DP031R	1069	EA120R	548	EA365R	560	EB009R	256, 591
DP035R	1069	EA121R	548	EA397R	557	EB011R	256, 592
DP501R	1073	EA124R	548	EA440R	556	EB012R	256, 592
DP505R	1073	EA125R	548	EA441R	556	EB050	598
DP520R	1077	EA126R	550	EA450R	558	EB052C	599
DP530R	1073	EA127R	550	EA466R	557	EB061R	601
DP540R	1072	EA130R	549	EA800R	570	EB062R	601
DP541R	1072	EA131R	549	EA820R	570	EB063R	601
DP551R	129, 1072	EA132R	554	EA821R	570	EB064R	601

Numerischer Index – Numerical Index

EB – EL

Art. Nr. Cat. No.	Seite Page	Art. Nr. Cat. No.	Seite Page	Art. Nr. Cat. No.	Seite Page	Art. Nr. Cat. No.	Seite Page
EB065R	601	EF055R	615	EF826R	630	EL181R	639
EB066R	601	EF056R	615	EF828R	630	EL182R	639
EB067R	601	EF070R	624	EF830R	630	EL183R	639
EB068R	601	EF155R	625	EF832R	630	EL184R	639
EB069R	601	EF163R	622	EF834R	630	EL185R	639
EB070R	601	EF164R	622	EF836R	630	EL192R	640
EB071R	601	EF167R	619	EF838R	630	EL193R	640
EB072R	601	EF168R	326, 622	EF840R	630	EL194R	640
EB073R	601	EF170R	622	EF842R	630	EL195R	640
EB074R	601	EF195R	625	EF844R	630	EL196R	640
EB075	601	EF208C	627	EF846R	630	EL407R	640
EB101R	599	EF210C	627	EF848R	630	EL408R	640
EB102R	599	EF212C	627	EF850R	630	EL409R	640
EB103R	599	EF214C	627	EF852R	630	EL410R	641
EB111R	602	EF216C	627	EF854R	630	EL411R	641
EB112R	602	EF218C	627	EF856R	630	EL413R	641
EB113R	602	EF220C	627	EF858R	630	EL420R	641
EB114R	602	EF306C	627	EF860R	630	EL421R	641
EB168R	602	EF308C	627	EF921R	200, 626	EL422R	641
EB169R	602	EF310C	627	EF928R	626	EL423R	641
EB170R	602	EF312C	627	EF965R	631	EL424R	641
EB171R	602	EF314C	627	EF966R	631	EL425R	641
EB172R	602	EF316C	627	EF967R	631	EL426R	641
EB173R	602	EF318C	627			EL427R	641
EB174R	602	EF400R	625	EJ126R	634	EL428R	641
EB175R	602	EF401R	625			EL440R	642
EB220R	603, 846	EF491C	628	EL010C	636	EL441R	642
EB221R	603	EF492R	628	EL011R	636	EL442R	642
EB225R	604	EF493R	628	EL013R	636	EL443R	642
EB231R	605	EF638R	600, 629	EL014R	636	EL444R	644
EB232R	605	EF639R	600, 629	EL015R	636	EL445R	644
EB233R	605	EF640R	600, 629	EL016R	636	EL446R	644
EB234R	605	EF641R	600, 629	EL040R	637	EL447R	644
EB239R	605	EF642R	600, 629	EL041R	638	EL448R	644
EB240R	605	EF643R	600, 629	EL042R	638	EL450R	643
EB242R	605	EF644R	600, 629	EL043R	638	EL451R	643
EB244R	616	EF645R	600, 629	EL044R	638	EL452R	643
EB246R	616	EF646R	600, 629	EL056R	637	EL453R	643
		EF647R	600, 629	EL057R	637	EL454R	645
EF001R	608	EF648R	600, 629	EL058R	637	EL455R	645
EF002R	608	EF649R	600, 629	EL075R	637	EL456R	645
EF003R	608	EF650R	600, 629	EL076R	638	EL457R	645
EF010R	609	EF651R	600, 629	EL077R	638	EL458R	645
EF011R	608	EF652R	600, 629	EL078R	638	EL480R	646
EF012R	610	EF653R	600, 629	EL079R	638	EL481R	646
EF015R	610	EF654R	600, 629	EL080R	638	EL491R	647
EF016R	610	EF655R	600, 629	EL081R	638	EL492R	647
EF030R	611	EF656R	600, 629	EL086R	637	EL493R	647
EF047R	614	EF657R	600, 629	EL087R	637	EL494R	647
EF048R	614	EF658R	600, 629	EL088R	637	EL495R	647
EF051R	614	EF659R	600, 629	EL150R	638	EL496R	647
EF052R	614	EF660R	600, 629	EL151R	638	EL497R	647
EF053R	614	EF790R	629	EL152R	638	EL498R	647
EF054R	614	EF824R	630	EL180R	639	EL499R	647



Numerischer Index – Numerical Index

EL – ER

Art. Nr. Cat. No.	Seite Page	Art. Nr. Cat. No.	Seite Page	Art. Nr. Cat. No.	Seite Page	Art. Nr. Cat. No.	Seite Page
EL550R	648	EL754R	658	EM140R	662	EO122R	675
EL551R	648	EL755R	658	EM141R	662	EO125R	676
EL558R	649	EL756R	658	EM142R	662	EO130R	677
EL559R	649	EL757R	658	EM143R	662	EO140R	677
EL578R	650	EL758R	658	EM144R	662	EO150R	678
EL579R	650	EL759R	658	EM145R	662	EO151R	678
EL581R	652	EL760R	658	EM146R	662	EO163R	197, 679
EL627R	650	EL859R	654	EM147R	662	EO164R	197, 679
EL628R	650	EL860R	654	EM193R	664	EO165R	198, 680
EL629R	650	EL865R	652	EM194R	664	EO166R	198, 680
EL631R	444, 651	EL868R	417, 655	EM231R	662	EO171R	681
EL632R	444, 651	EL870R	417, 655	EM232R	662, 663	EO177R	681
EL633R	444, 651	EL872R	417, 655	EM233R	662, 663	EO180R	682
EL634R	444, 651	EL873R	417, 655	EM234R	662, 663	EO202R	682
EL635R	444, 651			EM235R	662, 663	EO216R	683
EL636R	444, 651	EM097R	664	EM236R	662, 663	EO218R	683
EL637R	444, 651	EM098R	664	EM237R	662, 663	EO220R	684
EL638R	444, 651	EM099R	664	EM238R	662, 663	EO221R	684
EL639R	444, 651	EM100R	664	EM239R	662, 663	EO222R	684
EL642R	444, 651	EM101R	662, 664	EM244R	663	EO225R	684
EL644R	444, 651	EM102R	662, 664	EM245	663	EO226R	684
EL660R	651	EM103R	662, 664	EM271R	663	EO240R	684
EL690R	653	EM104R	662, 664	EM272R	663	EO242R	684
EL691R	653	EM105R	662, 664	EM273R	663	EO300R	688
EL693R	653	EM106R	662, 664	EM274R	663	EO310R	193, 594, 686
EL694R	653	EM107R	662, 664	EM275R	663	EO315R	193, 686
EL695R	653	EM108R	662, 664	EM276R	663	EO332R	596, 687
EL697R	653	EM109R	662, 664	EM277R	663	EO338R	191, 584, 595, 687, 837
EL698R	653	EM110R	662, 664	EM278R	663	EO340R	191, 584, 595, 687, 837
EL700R	653	EM111R	662, 664	EM710R	667	EO342R	688
EL702R	653	EM112R	662, 664	EM711R	667	EO405R	613, 688
EL703R	653	EM113R	662, 664			EO407R	613, 689
EL704R	653	EM114R	662, 664	EO005R	598, 670	EO415R	689
EL705R	653	EM115R	662, 664	EO010R	670	EO420R	689
EL707R	653	EM116R	662, 664	EO012R	670	EO433R	690
EL708R	653	EM117R	662, 664	EO013R	670	EO435R	690
EL720C	654	EM118R	662, 664	EO015R	670		
EL721C	654	EM119R	662, 664	EO016R	671	ER002R	697
EL722C	654	EM120R	662, 664	EO020	671	ER005R	626, 697
EL736R	656	EM121R	662, 664	EO030R	671	ER011R	698
EL738R	656	EM122R	662, 664	EO060R	200, 672	ER012R	698
EL739R	656	EM123R	662, 664	EO061R	200, 604, 672	ER015R	698
EL740R	657	EM124R	662, 664	EO075R	672	ER016R	698
EL741R	657	EM125R	662, 664	EO077R	672	ER025R	711
EL742R	657	EM126R	662, 664	EO080R	673	ER050R	699
EL743R	657	EM131R	662	EO082R	673	ER054R	700
EL744R	657	EM132R	662	EO085R	673	ER055R	700
EL745R	657	EM133R	662	EO105R	674	ER058R	699
EL746R	657	EM134R	662	EO106R	674	ER061R	701
EL747R	657	EM135R	662	EO108R	675	ER062R	701
EL748R	657	EM136R	662	EO110R	199, 675	ER063R	701
EL751R	658	EM137R	662	EO111R	676	ER064R	701
EL752R	658	EM138R	662	EO112R	199, 676	ER066R	703
EL753R	658	EM139R	662	EO115R	677	ER068R	706

Numerischer Index – Numerical Index

ER – FB

Art. Nr. Cat. No.	Seite Page	Art. Nr. Cat. No.	Seite Page	Art. Nr. Cat. No.	Seite Page	Art. Nr. Cat. No.	Seite Page
ER070R	703	ER402R	709	ET106R	722	FB055R	888
ER071R	704	ER403R	709	ET130R	724	FB108R	851
ER072R	702	ER404R	709	ET140R	124, 724	FB109R	851
ER073R	702	ER405R	709	ET141R	124, 724, 856	FB110R	851
ER076R	702	ER406R	709	ET142R	124, 724	FB112R	851
ER101R	707, 988	ER411R	709	ET150R	123, 723	FB113R	851
ER102R	707, 988	ER412R	709	ET152R	123, 723	FB114R	851
ER103R	707, 988	ER413R	709	ET160R	724	FB115R	851
ER104R	707, 988	ER414R	709	ET205R	726	FB116R	851
ER105R	707, 988	ER415R	709	ET210R	726	FB117R	851
ER106R	707, 988	ER416R	709	ET220R	727	FB119R	851
ER111R	707	ER421R	709	ET221R	727	FB120R	889
ER112R	707	ER422R	709	ET237R	727	FB121R	889
ER113R	707	ER423R	709	ET245R	728	FB122R	889
ER114R	707	ER424R	709	ET246R	728	FB124R	889
ER115R	707	ER425R	709	ET251R	729	FB125R	889
ER116R	707	ER426R	709	ET255R	729	FB126R	889
ER126R	707	ER520R	710	ET268R	730	FB150R	849
ER128R	707	ER521R	710	ET269R	731	FB151R	849
ER130R	707	ER522R	710	ET270R	730	FB153R	846
ER132R	707	ER523R	710	ET301R	732	FB154R	846
ER134R	707	ER524R	710	ET302R	732	FB155R	846
ER219R	708	ER525R	710	ET306R	732	FB156R	846
ER220R	708	ER526R	710	ET307R	732	FB158R	850
ER221R	708	ER580R	711	ET308R	732	FB159R	850
ER222R	708	ER585R	711	ET315R	732	FB160R	847
ER223R	708	ER602R	712	ET316R	732	FB161R	847
ER224R	708	ER611R	713	ET320R	734	FB162R	847
ER225R	708	ER612R	713	ET325R	733	FB163R	847
ER226R	708	ER621R	713	ET326R	733	FB164R	847
ER227R	708	ER623R	713	ET327R	733	FB165R	847
ER228R	708	ER626R	713	ET329R	735	FB166R	847
ER229R	708	ER627R	713			FB167R	847
ER230R	708	ER628R	713	FA001R	456	FB168R	847
ER241R	708	ER820C	715	FA005R	474	FB169R	847
ER242R	708	ER822C	715	FA006R	474	FB170R	847
ER243R	708	ER825C	715	FA007R	474	FB172R	847
ER244R	708	ER826C	715	FA025R	364	FB180R	852
ER245R	708	ER827C	715	FA026R	364	FB184R	852
ER246R	708	ER828C	715			FB185R	852
ER247R	708	ER829	715	FB030R	887	FB186R	852
ER248R	708	ER867R	717	FB031R	887, 888	FB194R	852
ER320R	708	ER871R	716	FB032R	887	FB195R	852
ER321R	708	ER872R	716	FB033	887	FB196R	852
ER322R	708	ER873R	716	FB034R	887	FB222R	738
ER323R	708	ER874R	716	FB035R	887	FB223R	739
ER324R	708	ER875	717	FB036R	887	FB224R	739
ER325R	708	ER876	717	FB037R	887	FB226R	739
ER326R	708			FB038R	887	FB227R	739
ER327R	708	ET002	720	FB040R	887	FB234R	740
ER328R	708	ET005R	720	FB050R	888	FB235R	741
ER329R	708	ET073R	720	FB051R	888	FB236R	741
ER330R	708	ET096R	721	FB053R	888	FB238R	741
ER401R	709	ET102R	722	FB054R	888		



Numerischer Index – Numerical Index

FB

Art. Nr. Cat. No.	Seite Page	Art. Nr. Cat. No.	Seite Page	Art. Nr. Cat. No.	Seite Page	Art. Nr. Cat. No.	Seite Page
FB239R	741	FB424R	219, 789	FB485R	798	FB554R	804
FB240R	742	FB425R	219, 789	FB486R	797	FB557R	792
FB242R	743	FB426R	219, 789	FB487R	797	FB558R	792
FB243R	742	FB427R	219, 789	FB488R	818	FB559R	793
FB245R	743	FB431R	218, 788	FB489R	818	FB560R	793
FB246R	744	FB432R	219, 789	FB490R	819	FB561R	793
FB248R	745	FB433R	219, 789	FB491R	819	FB563R	793
FB249R	744	FB434R	219, 789	FB492R	819	FB567R	792
FB251R	745	FB435R	219, 789	FB493R	563, 811	FB568R	792
FB252R	744	FB436R	219, 789	FB494R	563, 811	FB569R	792
FB253R	745	FB437R	219, 789	FB495R	817	FB570R	793
FB254R	742	FB440R	794	FB496R	797	FB573R	812
FB255R	743	FB441R	794	FB497R	797	FB574R	812
FB328R	217, 787	FB442R	794	FB498R	798	FB576R	817
FB329R	217, 787	FB443R	794	FB499R	798	FB578R	816
FB330R	217, 787	FB444R	795	FB500R	801	FB581R	791
FB331R	217, 787	FB445R	795	FB501R	801	FB582R	791
FB352R	218, 788	FB446R	794	FB502R	801	FB587R	803
FB353R	218, 788	FB447R	794	FB503R	801	FB588R	803
FB357R	218, 788	FB448R	794	FB504R	801	FB590R	791
FB358R	218, 788	FB449R	794	FB506R	802	FB591R	791
FB359R	218, 788	FB450R	805	FB507R	802	FB592R	791
FB362R	218, 788	FB451R	805	FB508R	802	FB593R	791
FB363R	218, 788	FB452R	804	FB510R	809	FB600R	843
FB364R	218, 788	FB453R	804	FB511R	809	FB602R	843
FB365R	218, 788	FB454R	804	FB512R	809	FB604R	843
FB366R	218, 788	FB455R	804	FB513R	809	FB605R	843
FB367R	218, 788	FB456R	804	FB515R	810	FB633R	844
FB369R	218, 788	FB457R	804	FB516R	810	FB634R	844
FB394R	160, 782	FB458R	799	FB517R	810	FB635R	844
FB395R	160, 782	FB459R	799	FB518R	810	FB651R	851
FB396R	160, 782	FB460R	799	FB519R	800	FB653R	851
FB400R	160, 546, 782	FB461R	799	FB520R	800	FB654R	851
FB401R	161, 783	FB462R	799	FB521R	800	FB700R	820
FB402R	160, 546, 782	FB463R	806	FB522R	800	FB701R	820
FB403R	161, 783	FB464R	806	FB523R	800	FB702R	820
FB404R	160, 546, 782	FB465R	806	FB524R	800	FB703R	820
FB405R	160, 546, 782	FB466R	807	FB525R	816	FB704R	820
FB406R	161, 546, 783	FB467R	807	FB526R	795	FB705R	820
FB407R	161, 546, 783	FB468R	807	FB527R	795	FB706R	820
FB408R	161, 546, 783	FB469R	807	FB528R	796	FB707R	820
FB409R	161, 546, 567, 783	FB470R	807	FB529R	796	FB708R	820
FB411R	160, 782	FB471R	815	FB530R	796	FB710R	826
FB412R	160, 782	FB472R	815	FB532R	795	FB711R	826
FB414R	160, 546, 782	FB473R	815	FB533R	795	FB712R	826
FB415R	160, 546, 782	FB475R	815	FB534R	795	FB713R	826
FB416R	160, 546, 782	FB476R	814	FB535R	795	FB714R	826
FB417R	160, 546, 782	FB477R	814	FB540R	790	FB715R	826
FB418R	160, 782	FB478R	814	FB541R	790	FB717R	824
FB419R	160, 782	FB480R	815	FB542R	790	FB718R	824
FB420R	219, 789	FB481R	813	FB543R	790	FB719R	824
FB421R	219, 789	FB482R	813	FB544R	790	FB721R	823
FB422R	219, 789	FB483R	798	FB552R	804	FB722R	823
FB423R	219, 789	FB484R	798	FB553R	804	FB723R	823

Numerischer Index – Numerical Index

FB – FD

Art. Nr. Cat. No.	Seite Page	Art. Nr. Cat. No.	Seite Page	Art. Nr. Cat. No.	Seite Page	Art. Nr. Cat. No.	Seite Page
FB724R	823	FB821R	874	FC004R	853	FD080R	282, 770
FB725R	823	FB822R	874	FC005R	853	FD081R	282, 770
FB726R	823	FB823R	874	FC014R	853	FD100R	53
FB727R	823	FB830R	866	FC015R	853	FD101R	53
FB729R	825	FB835R	867	FC025R	853	FD103R	53
FB730R	825	FB836R	867	FC030	853	FD230R	283, 771
FB731R	822	FB840R	877	FC034R	853	FD231R	283, 771
FB732R	822	FB841R	877	FC035R	853	FD232R	283, 771
FB734R	822	FB842R	877	FC040A	864	FD233R	283, 771
FB735R	822	FB844R	877	FC041A	864	FD240R	284, 772
FB736R	825	FB845R	872	FC042A	864	FD241R	284, 772
FB737R	825	FB846R	872	FC043A	864	FD242R	284, 772
FB738R	828	FB847R	866	FC044A	865	FD243R	284, 772
FB741R	821	FB850R	873	FC048R	854	FD244R	284, 772
FB742R	821	FB851R	873	FC049R	854	FD245R	284, 772
FB743R	821	FB852R	865	FC060R	875, 876	FD246R	284, 772
FB754R	827	FB853R	865	FC061R	876	FD247R	284, 772
FB755R	827	FB854R	865	FC062R	876	FD251R	60, 768
FB756R	827	FB855R	865	FC063R	876	FD252R	60, 768
FB764R	832	FB856R	865	FC064R	876	FD253R	150, 769
FB765R	833	FB857R	865	FC300R	834	FD255R	769
FB766R	827	FB858R	865	FC301R	834	FD258R	297, 769
FB767R	827	FB860R	882	FC302R	834	FD259R	297, 769
FB773R	829	FB861R	882	FC303R	834	FD280R	143
FB775R	830	FB862R	882	FC304R	834	FD281R	143
FB776R	831	FB865R	883	FC310R	834	FD284R	143
FB777R	831	FB866R	883	FC311R	834	FD285R	143
FB778R	831	FB870R	857	FC312R	834	FD286R	143
FB779R	831	FB873R	857	FC313R	834	FD287R	143
FB780R	831	FB878R	857	FC314R	834	FD333R	849
FB784R	161, 783	FB881R	857	FC411R	159, 546, 781	FD375R	363
FB785R	161, 783	FB882R	857	FC412R	159, 546, 781	FD376R	363
FB786R	161, 783	FB890R	858	FC413R	159, 546, 781	FD392R	363
FB795R	828	FB892R	858	FC418R	159, 546, 781	FD394R	358
FB800R	867	FB911R	855			FD395R	358
FB802R	867	FB918R	856	FD011R	50	FD396R	358
FB803R	868	FB930R	542, 839	FD012R	50	FD397R	358
FB804R	868	FB934R	540, 839	FD013R	50	FD398R	358
FB805R	869	FB936R	545, 835	FD014R	50	FD399R	358
FB806R	869	FB938R	539, 839	FD015R	50	FD552R	210
FB807R	869	FB940R	842	FD016R	51	FD554R	210
FB808R	870	FB950R	845	FD017R	51	FD556R	210
FB809R	870	FB954R	273, 561, 845	FD018R	52	FD558R	210
FB810R	870	FB955R	273, 561, 845	FD019R	52	FD560R	210
FB811R	870	FB956R	272, 560, 808	FD020R	52	FD561R	210
FB812R	870	FB957R	272, 560, 808	FD021R	52	FD562R	210
FB813R	871	FB958R	272, 560, 808	FD022R	52	FD568R	210, 211
FB814R	871	FB961R	840	FD023R	52	FD569R	210, 211
FB815R	871	FB971R	884	FD028R	51	FD571R	211
FB816R	871	FB972R	884	FD045R	282, 770	FD572R	211
FB817R	871	FB973R	884	FD046R	282, 770	FD575R	212
FB818R	871	FB974R	884	FD048R	282, 770	FD578R	210
FB819R	871	FB975R	884	FD076R	282, 770	FD610R	1046
FB820R	874	FB976R	884	FD079R	282, 770	FD611R	211



Numerischer Index – Numerical Index

FD – FH

Art. Nr. Cat. No.	Seite Page	Art. Nr. Cat. No.	Seite Page	Art. Nr. Cat. No.	Seite Page	Art. Nr. Cat. No.	Seite Page
FD612R	211	FF066R	1052	FF662R	897	FF771R	897
FD613R	211	FF067R	1052	FF663R	897	FF772R	897
FD614R	211	FF068R	1052	FF664R	897	FF773R	897
FD615R	211	FF130R	925	FF665R	897	FF774R	903
FD635R	212	FF133C	925	FF682R	897	FF775R	903
FD636R	212	FF291R	928	FF683R	897	FF776R	903
		FF292R	928	FF684R	897	FF777R	903
FE005K	213	FF293R	928	FF685R	897	FF778R	903
FE010K	213	FF294R	928	FF692R	898	FF779R	903
FE011K	213	FF295R	929	FF693R	898	FF781R	898
FE012K	213	FF300R	850	FF694R	898	FF782R	898
FE013K	213	FF301R	850	FF695R	898	FF783R	898
FE014K	213	FF302R	850	FF707R	376	FF784R	898
FE020K	213	FF308R	929	FF708R	376	FF785R	898
FE021K	213	FF309	339	FF709R	376	FF799R	902
FE022K	213	FF313R	360	FF711R	898	FF800R	902
FE023K	213	FF321R	360	FF712R	898	FF801R	902
FE024K	213	FF322R	360	FF713R	898	FF803R	906
FE030S	214, 784	FF345R	909	FF714R	898	FF805R	906
FE031S	214, 784	FF346R	962	FF715R	897	FF806R	907
FE032S	215, 785	FF347R	929	FF716R	896	FF807R	906
FE034S	215, 785	FF348R	929	FF717R	897	FF808R	911
FE040S	214, 784	FF349R	929	FF718R	896	FF810R	907
FE041S	214, 784	FF502R	905	FF719R	896	FF811R	907
FE042S	215, 785	FF503R	905	FF720R	897	FF814R	907
FE044S	215, 785	FF504R	905	FF721R	896	FF818R	911
		FF513R	905	FF722R	897	FF820R	909
		FF514R	905	FF723R	896	FF832R	904
FF011R	731	FF523R	906	FF724R	897	FF833R	904
FF031R	1053	FF524R	906	FF725R	898	FF834R	904
FF032R	1053	FF532R	905	FF726R	897	FF835R	904
FF033R	1053	FF533R	905	FF727R	897	FF842R	904
FF034R	1053	FF534R	905	FF728R	897	FF843R	904
FF035R	1053	FF535R	905	FF729R	897	FF844R	904
FF036R	1053	FF536R	905	FF730R	929	FF852R	904
FF037R	1053	FF543R	905	FF737R	897	FF853R	904
FF038R	1053	FF544R	905	FF738R	897	FF854R	904
FF039R	1053	FF545R	905	FF741R	896	FF856R	910
FF040R	1053	FF553R	906	FF742R	896	FF857R	910
FF041R	1053	FF554R	906	FF743R	896	FF858R	910
FF042R	1053	FF562R	905	FF746R	897	FF913R	997
FF043R	1053	FF563R	905	FF747R	897	FF914R	997
FF044R	1053	FF564R	905	FF748R	897	FF915R	997
FF047R	1053	FF565R	905	FF749R	897		
FF048R	1053	FF566R	905	FF750R	896	FG052R	1035
FF052R	1053	FF573R	905	FF752R	896	FG055R	895
FF053R	1053	FF574R	905	FF754R	896	FG057R	912
FF055R	1052	FF575R	905	FF755R	896		
FF056R	1052	FF583R	906	FF765R	902	FH001	916
FF057R	1052	FF584R	906	FF766R	902	FH002	916
FF061R	1052	FF599R	908	FF767R	902	FH003	916
FF062R	1052	FF600R	908	FF768R	902	FH004	916
FF063R	1052	FF605R	908	FF769R	897	FH005	916
FF064R	1052	FF661R	897	FF770R	897	FH010	916
FF065R	1052						

Numerischer Index – Numerical Index

FH – FK

Art. Nr. Cat. No.	Seite Page	Art. Nr. Cat. No.	Seite Page	Art. Nr. Cat. No.	Seite Page	Art. Nr. Cat. No.	Seite Page
FH014	916	FK130R	931	FK245R	953	FK384R	862, 975
FH100R	28, 917	FK131R	931	FK246R	954	FK387R	862, 975
FH101R	28, 917	FK133R	931	FK251	959	FK390R	971
FH102R	28, 917	FK135R	933	FK252	959	FK391R	972
FH103R	28, 917	FK136R	933	FK253	959	FK394R	969
FH116R	28, 917	FK139R	931	FK254	959	FK395R	969
FH150R	28, 917	FK140R	933	FK291R	964	FK396R	969
FH160R	29, 918	FK141R	930	FK292R	964	FK397R	969
FH166R	29, 918	FK146R	974	FK293R	964	FK400R	861, 976
FH170R	29, 918	FK147R	974	FK299R	968	FK401R	861, 976
FH191R	29, 918	FK148R	974	FK300R	961	FK402R	861, 976
FH192R	29, 918	FK149R	974	FK301R	968	FK403R	861, 976
FH194R	33, 919	FK156R	934	FK302R	968	FK408R	861, 976
FH197R	33, 919	FK157R	974	FK303R	961	FK409R	861, 976
FH220R	920	FK158R	944	FK306R	968	FK410R	972
FH222R	920	FK160R	934	FK307R	968	FK411R	972
FH300R	921	FK161R	935	FK308R	968	FK412R	972
FH301C	921	FK162R	935	FK309R	968	FK413R	972
FH302C	921	FK166R	937	FK310R	961	FK414R	972
FH305R	921	FK167R	936	FK314R	969	FK420R	863, 974
FH306R	921	FK168R	943	FK317R	970	FK505R	980
FH307C	921	FK169R	943	FK318R	970	FK507R	980
FH308C	921	FK170R	936	FK319R	970	FK510R	980
FH310C	921	FK171R	937	FK321R	970	FK511R	980
FH312C	921	FK172R	940	FK323R	970	FK530R	967
FH313R	922	FK173R	940	FK324R	970	FK532R	967
FH314C	922	FK174R	938	FK325R	970	FK534R	967
FH315C	922	FK175R	938	FK328R	969	FK541R	967
FH316C	922	FK176R	939	FK329R	969	FK542R	967
FH320R	922	FK177R	944	FK336R	973	FK543R	967
FH325R	923	FK180R	945	FK340R	971	FK552R	967
FH326R	923	FK185R	936	FK341R	971	FK562R	967
FH335R	923	FK186R	937	FK344R	971	FK611R	984
FH403	924	FK187R	942	FK345R	971	FK612R	984
FH404	924	FK188R	939	FK348R	977	FK613R	984
FH405	924	FK189R	941	FK350R	971	FK614R	984
FH407	924	FK193R	945	FK351R	973	FK615R	984
FH413	924	FK211R	947	FK352R	977	FK616R	984
FH414	924	FK212R	947	FK353R	977	FK617R	984
FH415	924	FK213R	947	FK355R	863, 973	FK621R	984
FH430R	924	FK214R	950	FK356R	863, 973	FK622R	984
FH480R	924	FK215R	950	FK357R	863, 973	FK623R	984
		FK218R	948	FK358R	863, 973	FK624R	984
FK110R	930	FK219R	948	FK359R	863, 973	FK625R	984
FK111R	932	FK221R	957	FK360R	863, 972	FK626R	984
FK113R	932	FK222R	955	FK361R	972	FK627R	984
FK114R	932	FK223R	952	FK362R	972	FK630R	984
FK116R	932	FK224R	949	FK365R	973	FK631R	984
FK117R	932	FK231R	958	FK366R	973	FK632R	984
FK118R	932	FK238R	959	FK378R	972	FK633R	984
FK119R	932	FK239R	951	FK379R	971	FK634R	984
FK120R	930	FK241R	956	FK381R	862, 975	FK635R	984
FK121R	930	FK243R	953	FK382R	862, 975	FK636R	984
FK124R	931	FK244R	954	FK383R	862, 975	FK637R	984



Numerischer Index – Numerical Index

FK – FL

Art. Nr. Cat. No.	Seite Page	Art. Nr. Cat. No.	Seite Page	Art. Nr. Cat. No.	Seite Page	Art. Nr. Cat. No.	Seite Page
FK638R	984	FK845R	981	FK932R	898	FL060R	995
FK639R	984	FK846R	981	FK933R	898	FL062R	994
FK658R	984	FK848R	982	FK934R	898	FL064R	994
FK659R	984	FK850R	981	FK936R	898	FL065R	994
FK660R	983	FK854R	989	FK937R	898	FL066R	996
FK661R	983	FK855R	989	FK938R	898	FL068C	996
FK662R	985	FK863R	989	FK939R	898	FL069C	996
FK663R	985	FK864R	989	FK940R	898	FL070S	995
FK664R	985	FK900B	897	FK943R	898	FL090R	997
FK665R	985	FK900R	897	FK944R	898	FL091R	997
FK666R	989	FK901B	897	FK945R	898	FL092R	997
FK668R	989	FK901R	897	FK946R	898	FL093R	997
FK670R	989	FK902B	897	FK948B	896	FL094R	997
FK672R	989	FK902R	897	FK948R	896	FL095R	997
FK675R	985	FK903B	897	FK949B	896	FL096R	997
FK676R	985	FK903R	897	FK949R	896	FL097R	997
FK677R	985	FK904B	897	FK950B	896	FL098R	997
FK678R	985	FK904R	897	FK950R	896	FL101R	1001
FK679R	985	FK905B	897	FK951B	896	FL102R	1001
FK684R	985	FK905R	897	FK951R	896	FL104R	1001
FK685R	985	FK906B	897	FK952B	896	FL106R	1001
FK686R	985	FK906R	897	FK952R	896	FL108R	1001
FK688R	988	FK907B	897	FK953B	896	FL109R	1001
FK689R	988	FK907R	897	FK953R	896	FL110R	999
FK690R	988	FK908B	897	FK954R	896	FL112R	999
FK702R	986	FK908R	897	FK955R	896	FL114R	999
FK703R	986	FK909B	897	FK956R	896	FL116R	999
FK704R	986	FK909R	897	FK957R	896	FL118R	999
FK705R	986	FK910B	897	FK958R	896	FL120R	999
FK712R	986	FK910R	897	FK959R	896	FL122R	999
FK713R	986	FK913B	897	FK961B	897	FL124R	999
FK714R	986	FK913R	897	FK961R	897	FL126R	999
FK715R	986	FK914B	897	FK962B	897	FL128R	999
FK723R	986	FK914R	897	FK962R	897	FL130R	999
FK724R	986	FK915B	897	FK963B	897	FL132R	999
FK725R	986	FK915R	897	FK963R	897	FL134R	999
FK773R	988	FK916B	897	FK964B	897	FL136R	999
FK774R	988	FK916R	897	FK964R	897	FL138R	999
FK775R	988	FK917B	897	FK965B	897	FL144R	998
FK783R	988	FK917R	897	FK965R	897	FL146R	998
FK784R	988	FK919R	897			FL148R	998
FK785R	988	FK920R	897	FL010	994	FL153R	998
FK800R	981	FK921R	897	FL011	994	FL173R	1000
FK801R	981	FK922R	897	FL034	992	FL174R	1000
FK803R	981	FK925B	897	FL035R	992	FL175R	1000
FK813R	981	FK925R	897	FL036R	992	FL176R	1000
FK814R	981	FK926B	897	FL037	992	FL183R	1000
FK817R	981	FK926R	897	FL038R	992	FL184R	1000
FK834R	988	FK927B	897	FL039R	992	FL185R	1000
FK835R	988	FK927R	897	FL044R	993	FL186R	1000
FK836R	988	FK928B	897	FL045R	994	FL187R	1000
FK840R	981	FK928R	897	FL047	994	FL213R	1000
FK841R	981	FK930R	898	FL055R	995	FL214R	1000
FK842R	981	FK931R	898	FL059R	996	FL215R	1000

Numerischer Index – Numerical Index

FL – FM

Art. Nr. Cat. No.	Seite Page	Art. Nr. Cat. No.	Seite Page	Art. Nr. Cat. No.	Seite Page	Art. Nr. Cat. No.	Seite Page
FL216R.....	1000	FL523R	1003	FM010R.....	55	FM476R	59, 749
FL223R	1000	FL524R	1003	FM011R.....	55	FM477R	59, 749
FL224R	1000	FL525R	1003	FM012R.....	55	FM478R	59, 749
FL225R	1000	FL526R	1003	FM013R.....	55	FM479R	59, 749
FL226R	1000	FL527R	1003	FM014R.....	55	FM480R	59, 749
FL227R	1000	FL553R	1003	FM021R.....	285	FM481R	59, 749
FL343R.....	1001	FL554R	1003	FM033R.....	142	FM482R	59, 749
FL345R.....	1001	FL555R.....	1003	FM034R.....	142	FM483R	59, 749
FL347R.....	1001	FL556R.....	1003	FM035R.....	142	FM484R	59, 749
FL380R.....	1007	FL557R.....	1003	FM036R.....	142	FM485R.....	59, 749
FL381R.....	1007	FL573R.....	1003	FM040R.....	55	FM486R.....	59, 749
FL382R.....	1007	FL574R.....	1003	FM041R.....	55	FM488R.....	59, 749
FL383R.....	1007	FL575R.....	1003	FM042R.....	60, 768	FM489R.....	59, 749
FL384R.....	1007	FL576R.....	1003	FM043R.....	60, 768	FM490R.....	59, 749
FL390R.....	1007	FL577R.....	1003	FM047R.....	769	FM491R.....	59, 749
FL391R.....	1007	FL583R.....	1003	FM053R.....	150, 755	FM492R.....	59, 749
FL392R.....	1007	FL585R.....	1003	FM054R.....	150, 755	FM493R.....	59, 749
FL393R.....	1007	FL650R.....	1005	FM061R.....	285	FM503R.....	59, 749
FL394R.....	1007	FL651R.....	1005	FM063R.....	150, 755	FM504R.....	59, 749
FL401R.....	1008	FL652R.....	1005	FM218R.....	289, 759	FM505R.....	59, 749
FL402R.....	1008	FL653R.....	1005	FM221R.....	289, 759	FM506R.....	59, 749
FL403R.....	1008	FL654R.....	1005	FM223R.....	289, 759	FM507R.....	59, 749
FL405R.....	1008	FL655R.....	1005	FM228R.....	289, 759	FM508R.....	59, 749
FL406R.....	1008	FL656R.....	1005	FM230R.....	289, 759	FM520R.....	289, 759
FL407R.....	1008	FL658R.....	1005	FM236R.....	297, 767	FM521R.....	289, 759
FL408R.....	1008	FL659R.....	1005	FM276R.....	297, 767	FM522R.....	289, 759
FL411R.....	1008	FL660R.....	1005	FM388R.....	287, 774	FM523R.....	289, 759
FL412R.....	1008	FL661R.....	1005	FM390R.....	287, 774	FM524R.....	289, 759
FL413R.....	1008	FL662R.....	1005	FM392R.....	772	FM525R.....	289, 759
FL415R.....	1008	FL665R.....	1006	FM398R.....	772	FM526R.....	289, 759
FL416R.....	1008	FL666R.....	1006	FM430R.....	57, 747	FM527R.....	289, 759
FL417R.....	1008	FL668R.....	1006	FM431R.....	57, 747	FM528R.....	289, 759
FL418R.....	1008	FL670R.....	1006	FM432R.....	57, 747	FM529R.....	289, 759
FL420R.....	1008	FL672R.....	1006	FM433R.....	57, 747	FM530R.....	289, 759
FL423R.....	1010	FL682R.....	1006	FM434R.....	57, 747	FM531R.....	289, 759
FL430R.....	1010	FL685R.....	1006	FM435R.....	57, 747	FM532R.....	289, 759
FL437R.....	1009	FL686R.....	1006	FM436R.....	57, 747	FM533R.....	289, 759
FL438R.....	1009	FL687R.....	1006	FM437R.....	57, 747	FM534R.....	291, 761
FL439R.....	1009	FL701R.....	1008	FM438R.....	57, 747	FM535R.....	291, 761
FL440R.....	1009	FL702R.....	1008	FM439R.....	57, 747	FM536R.....	291, 761
FL441R.....	1009	FL711R.....	998	FM440R.....	57, 747	FM537R.....	291, 761
FL443R.....	1009	FL781R.....	1005	FM441R.....	57, 747	FM538R.....	291, 761
FL445R.....	1009	FL783R.....	1005	FM442R.....	57, 747	FM539R.....	291, 761
FL503R.....	1003	FL785R.....	1005	FM444R.....	57, 747	FM540R.....	293, 763
FL504R.....	1003	FL788R.....	1005	FM451R.....	57, 747	FM541R.....	293, 763
FL505R.....	1003	FL789R.....	1005	FM452R.....	57, 747	FM542R.....	293, 763
FL506R.....	1003	FL790R.....	1005	FM453R.....	57, 747	FM543R.....	293, 763
FL507R.....	1003			FM454R.....	57, 747	FM544R.....	293, 763
FL512R.....	1003	FM001R.....	141	FM455R.....	57, 747	FM545R.....	293, 763
FL513R.....	1003	FM002R.....	141	FM470R.....	57, 747	FM546R.....	293, 763
FL514R.....	1003	FM003R.....	141	FM471R.....	57, 747	FM547R.....	293, 763
FL515R.....	1003	FM004R.....	141	FM472R.....	57, 747	FM548R.....	293, 763
FL516R.....	1003	FM005R.....	141	FM473R.....	57, 747	FM549R.....	293, 763
FL517R.....	1003	FM006R.....	141	FM474R.....	57, 747	FM550R.....	295, 765



Numerischer Index – Numerical Index

FM – FR

Art. Nr. Cat. No.	Seite Page	Art. Nr. Cat. No.	Seite Page	Art. Nr. Cat. No.	Seite Page	Art. Nr. Cat. No.	Seite Page
FM551R	295, 765	FO116R	1015	FO428R	1028	FO634R	1039
FM552R	295, 765	FO117R	1014	FO430R	1028	FO636R	1039
FM553R	295, 765	FO118R	1015	FO432R	1028	FO640R	1040
FM554R	295, 765	FO119R	1014	FO440R	1029	FO641R	1040
FM555R	295, 765	FO120R	1018	FO442R	1029	FO645R	1041
FM560R	296, 766	FO123R	1016	FO450R	1029	FO646R	1041
FM561R	296, 766	FO124R	1016	FO451R	1029	FO647R	1041
FM563R	289, 759	FO125R	1016	FO453R	1029	FO648R	859, 1042
FM564R	289, 759	FO127R	1018	FO455R	1029	FO649R	859, 1042
FM565R	289, 759	FO130R	1018	FO457R	1028	FO800R	1043
FM566R	289, 759	FO135R	859, 1018	FO460R	1030	FO801R	1043
FM567R	289, 759	FO136R	859, 1018	FO461R	1030	FO807R	1043
FM568R	289, 759	FO140R	1019	FO462R	1030	FO808R	1043
FM570R	145, 753	FO141R	1019	FO463R	1030	FO810R	1043
FM571R	145, 753	FO143R	1019	FO467R	1030	FO816R	1043
FM572R	145, 753, 769	FO144R	1022	FO470R	1030	FO820R	913
FM573R	145, 753	FO145R	1022	FO472R	1030	FO855R	1044
FM574R	145, 753	FO146R	1022	FO474R	1031	FO856R	1044
FM575R	145, 753	FO148R	1021	FO475R	1031	FO857R	1044
FM576R	145, 753	FO150R	1020	FO500R	1032	FO900R	1079
FM577R	145, 753	FO151R	1020	FO502R	1032	FO901R	1079
FM578R	145, 753	FO153R	1016	FO511R	1032	FO903R	1079
FM579R	145, 753	FO158R	1021	FO514R	1032	FO912R	1049
FM580R	145, 753	FO159R	1021	FO515R	1032	FO913R	1049
FM581R	145, 753	FO160R	1024	FO518R	1032	FO919	1049
FM582R	147, 755	FO161R	1024	FO520R	1032	FO920	1049
FM583R	145, 753	FO162R	1024	FO521R	1032	FO923R	1046
FM584R	147, 755	FO169R	1023	FO522R	1033	FO925R	1046
FM585R	145, 753	FO170R	1023	FO523R	1033	FO928R	1046
FM586R	147, 755	FO171R	1023	FO525R	1033	FO930R	1046
FM587R	147, 755	FO172R	1023	FO526R	1033	FO931R	1047
FM588R	147, 755	FO173R	1023	FO527R	1033	FO932R	1047
FM589R	147, 755	FO180R	1023	FO530R	1034	FO933R	1047
FM590R	147, 755	FO181R	1023	FO532R	1034	FO934R	1047
FM591R	147, 755	FO182R	1023	FO534R	1034	FO935R	1047
FM592R	145, 753	FO183R	1023	FO550R	1035	FO937R	1047
FM593R	145, 753	FO190R	1025	FO551R	1035	FO939R	1047
FM594R	145, 753	FO191R	1025	FO555R	860, 1036	FO940R	1048
FM595R	145, 753	FO192R	1025	FO566R	1036	FO950R	194
FM596R	145, 753	FO193R	1025	FO570R	860, 1037	FO951R	194
FM597R	147, 755	FO199R	1025	FO572R	860, 1037		
FM598R	147, 755	FO216R	116	FO599R	1026	FR005R	1054
FM599R	145, 753	FO399R	1026	FO601R	1038	FR010R	1054
FM600R	145, 753	FO400R	1026	FO602R	1038	FR011R	1054
		FO406R	1026	FO604R	1038	FR103R	1064
FO100R	1017	FO407R	1026	FO610R	1040	FR105R	1064
FO105R	1015	FO408R	1026	FO611R	1040	FR110R	1055
FO106R	1015	FO409R	1026	FO612R	1040	FR118R	1055
FO108R	1015	FO410R	1027	FO614R	1040	FR120R	1055
FO110R	1017	FO411R	1027	FO620R	1039	FR125R	1055
FO111R	1017	FO412R	1028	FO622R	1039	FR140R	1057
FO112R	1016	FO413R	1027	FO624R	1039	FR141R	1057
FO113R	1014	FO415R	1028	FO626R	1039	FR142R	1057
FO115R	1014	FO416R	1028	FO632R	1039		

Numerischer Index – Numerical Index

GA - GK

Art. Nr. Cat. No.	Seite Page	Art. Nr. Cat. No.	Seite Page	Art. Nr. Cat. No.	Seite Page	Art. Nr. Cat. No.	Seite Page
GA031R	1054	GF757R	1097	GF957	725	GK157R	511
		GF763R	1099	GF980R	1103	GK164R	510
GB020R	1006	GF764R	1099			GK165R	510
		GF765R	1099	GH201	9	GK174R	510
GC002R	1054	GF766R	1099	GH204	9	GK180	522
GC004R	1054	GF767R	1099	GH700	9	GK181	522
GC006R	1054	GF768R	1099	GH703	9	GK183	533
GC007R	1054	GF770R	1099	GH712	9	GK185	533
GC008R	1054	GF771R	1099	GH715	9	GK188	533
GC009R	1054	GF772R	1098, 1099			GK193	534
GC010R	1054	GF773R	1098, 1099	GK005R	516	GK194	534
GC012R	1054	GF774R	1098, 1099	GK006R	517	GK200	533
GC013R	1054	GF775R	1099	GK007R	516	GK202	534
GC014R	1054	GF801C	1092	GK008R	517	GK210	533
GC016R	1054	GF805C	1091	GK009R	517	GK211	534
GC391R	1054	GF806C	1091	GK010R	516	GK212	534
GC395R	1054	GF809C	1091	GK012R	516	GK213	533
GC397R	1054	GF816C	1093	GK013R	516	GK216	533
		GF841	1092	GK015R	517	GK217	534
GF350R	1095	GF860R	1093	GK016R	517	GK239	522
GF351R	1095	GF862R	1093	GK017R	517	GK245	522
GF352R	1095	GF867C	886, 1104	GK033R	516	GK246	522
GF353R	1095	GF905R	1104	GK110R	509	GK252Y	507
GF354R	1095	GF906R	1100	GK111R	509	GK253Y	507
GF355R	1095	GF907R	1100	GK112R	509	GK299	523
GF360R	1102	GF908R	1100	GK113R	509	GK301R	514
GF361R	1102	GF909R	1100	GK114R	509	GK303R	514
GF362R	1102	GF910R	1104	GK115R	509	GK305R	514
GF363R	1102	GF911R	1104	GK116R	509	GK307R	514
GF364R	1102	GF912R	1104	GK117R	509	GK310R	514
GF365R	1102	GF913R	1104	GK118R	509	GK315R	514
GF370R	1102	GF917R	1095	GK121R	510	GK320R	514
GF371R	1102	GF918R	1095	GK122R	510	GK321R	514
GF372R	1102	GF919R	1100	GK123R	510	GK424R	512
GF373R	1102	GF923R	1096	GK125R	511	GK550	521, 1105
GF374R	1102	GF925R	1096	GK127R	511	GK595R	526
GF375R	1102	GF932R	1097	GK128R	511	GK596R	526
GF380R	1102	GF933R	1096	GK129R	511	GK597R	526
GF381R	1102	GF935R	1097	GK131R	512	GK604R	527
GF382R	1102	GF936R	1097	GK132R	512	GK605R	527
GF383R	1102	GF937R	1097	GK133R	512	GK606R	527
GF384R	1102	GF938R	1097	GK140R	509	GK624R	527
GF385R	1102	GF939R	1095	GK141R	509	GK625R	527
GF704R	714, 1090	GF940R	1095	GK142R	509	GK680R	514
GF706R	714, 1090	GF941R	1095	GK143R	509	GK681R	514
GF708R	714, 1090	GF942R	1095	GK144R	509	GK683R	514
GF710R	714, 1090	GF944R	885, 1093	GK145R	509	GK685R	528, 620
GF712R	714, 1090	GF946R	885, 1094	GK146R	509	GK690R	523
GF714R	714, 1090	GF947R	885, 1094	GK147R	509	GK700R	525
GF719R	1090	GF948R	885, 1094	GK148R	509	GK701R	525
GF720R	714, 1090	GF950C	725	GK151R	510	GK703R	525
GF721	714, 1090	GF954R	725	GK152R	510	GK711R	525
GF722	714, 1090	GF955R	725	GK153R	510	GK713R	525
GF756R	1097	GF956R	725	GK155R	511	GK720R	523



Numerischer Index – Numerical Index

GK – LX

Art. Nr. Cat. No.	Seite Page	Art. Nr. Cat. No.	Seite Page	Art. Nr. Cat. No.	Seite Page	Art. Nr. Cat. No.	Seite Page
GK722R	523	GT710	9	JG522R	1108	LX015S	1058
GK723R	523	GT730	9	JG523R	1108	LX016S	1058
GK730R	523	GT736	9	JG524R	1108	LX017S	1058
GK737R	518	GT742	9	JG525R	1108	LX018S	1058
GK738R	518	GT746	9	JG598	1113, 1115	LX020S	1058
GK739R	518	GT748	9	JG600	1113, 1115	LX022S	1058
GK807R	524	GT754	9	JG820R	1109	LX025S	1058
GK808R	524	GT758	9	JG822R	1109	LX030S	1058
GK809R	524	GT770	9	JG850R	19	LX032S	1058
GK881R	528	GT779	9			LX034S	1058
GK882R	528	GT782	9	KX108S	1063	LX035S	1058
GK883R	528	GT784	9	KX110S	1063	LX036S	1058
GK884R	528			KX112S	1063	LX038S	1058
GK885R	528	HF014R	11, 130	KX114S	1063	LX040S	1058
GK886R	528	HF019R	11, 130	KX115S	1063	LX042S	1058
GK891R	529	HF020R	11, 130	KX116S	1063	LX045S	1058
GK892R	529	HF021R	11, 130	KX118S	1063	LX047S	1058
GK893R	529	HF028R	11, 130	KX120S	1063	LX098S	1059
GK894R	529	HF030R	11, 130	KX121S	1063	LX100S	1059
GK895R	529	HF031R	11, 130	KX125S	1063	LX108S	1059
GK896R	529	HF032R	11, 130	KX245S	1063	LX110S	1059
		HF213R	12	KX248S	1063	LX112S	1059
GN073	533	HF234R	12	KX250S	1063	LX114S	1059
GN074	533	HF250R	12	KX255S	1063	LX115S	1059
GN076	533	HF266R	1079	KX260S	1063	LX116S	1059
GN077	533	HF400R	11, 130	KX261	1063	LX117S	1059
GN078	533	HF409R	11, 130	KX262	1063	LX118S	1059
GN080	532	HF514R	13			LX120S	1059
GN081	532	HF519C	13	KY002S	1065	LX122S	1059
GN082	532	HF520R	13	KY003S	1065	LX125S	1059
GN083	532	HF566R	13	KY004S	1065	LX128S	1059
GN084	531			KY005S	1065	LX130S	1059
GN085	532	JF112R	666	KY006S	1065	LX132S	1059
GN086	531	JF212R	665, 666	KY007S	1065	LX134S	1059
GN202	522	JF489R	665	KY008S	1065	LX135S	1059
GN203	506, 513	JF905	665, 666	KY009S	1065	LX136S	1059
GN204	522	JF906R	665, 666	KY010S	1065	LX137S	1059
GN205	506, 513	JF907R	665, 666	KY012S	1065	LX138S	1059
GN206	507	JF908R	665, 666	KY015S	1065	LX140S	1059
GN207	506	JF909R	665, 666	KY100S	1065	LX142S	1059
GN208	507	JF910R	665, 666	KY201R	1066	LX145S	1059
GN209	506	JF915R	665, 666	KY202R	1066	LX146S	1059
GN210	508			KY203R	1066	LX149R	1068, 1075
GN211	508	JG161R	664	KY204R	1066	LX150R	1077
GN212	508	JG170R	664	KY205R	1066	LX152R	1077
GN213	506	JG504R	1108	KY206R	1066	LX156R	1074
GN215	506	JG506R	1108	KY220S	1065	LX157R	1074
GN216	522	JG508R	1108	KY225R	1065	LX158R	1076
GN217	533	JG514R	1108			LX159R	1076
GN218	507	JG515R	1108	LX002R	1059	LX162R	1075
GN221	508	JG516R	1108	LX008S	1058	LX163R	1077
GN227	513	JG518R	1108	LX010S	1058	LX164R	1078
GN229	513	JG520R	1108	LX012S	1058	LX165R	1078
GN310	531	JG521R	1108	LX014S	1058	LX170R	1069

Numerischer Index – Numerical Index

LX – OA

Art. Nr. Cat. No.	Seite Page	Art. Nr. Cat. No.	Seite Page	Art. Nr. Cat. No.	Seite Page	Art. Nr. Cat. No.	Seite Page
LX171R	1069	LX575R	1085	MB285R	217, 787	MD124R	1096
LX172R	1069	LX582R	1086	MB291R	170	MD125R	1096
LX174R	1070	LX587R	1086	MB454R	170	MD127R	1096
LX175S	1059	LX600R	1087	MB576R	1070	MD129R	1096
LX176R	1067	LX605R	1087	MB603R	344	MD452R	18
LX177R	1070	LX610R	1087	MB613R	821	MD453R	18
LX178R	1070	LX618R	1087	MB657R	1004	MD454R	18
LX180S	1059	LX624R	1087	MB658R	1004	MD455	1025
LX181R	1071	LX901S	1058	MB659R	1004	MD456R	312, 1068
LX182R	1071	LX902S	1058	MB660R	1004	MD463	173
LX183R	1071	LX911S	1058	MB661R	1004	MD464	224
LX185R	1071	LX912S	1058	MB662R	1004	MD465R	224
LX189R	1070	LX913S	1058	MB663R	1004	MD466R	224
LX190R	1071	LX915S	1058	MB664R	1004	MD467R	224
LX202S	1064	LX917S	1058	MB665R	1004	MD468	224
LX203R	1064	LX921S	1058	MB666R	1004	MD469	224
LX204R	1062	LX922S	1058	MB667R	1004	MD470	545, 835
LX205R	1062	LX923S	1058	MB668R	1004	MD497	386
LX206R	1062	LX925S	1058	MB669R	1004	MD563	945
LX207R	1062	LX927S	1058	MB675R	1004	MD568	538
LX208R	1062	LX951S	1058	MB676R	1004	MD569	245
LX209R	1062	LX952S	1058	MB677R	1004	MD570R	245
LX210R	1064	LX953S	1058	MB678R	1004	MD581	362
LX211R	1060	LX955S	1058	MB679R	1004	MD591	262
LX212R	1060	LX957S	1058	MB680R	1004	MD592	262
LX213R	1060			MB681R	1004	MD615	1031
LX214R	1060	MB229R	221	MB682R	1004	MD617	1029
LX215R	1060	MB238R	842	MB683R	1004		
LX216R	1060	MB239R	842	MB684R	1004	ND087R	912
LX218R	1060	MB245	848	MB685R	1004	ND105R	1010
LX222R	1060	MB246	848	MB686R	1004	ND108R	1010
LX223R	1060	MB247	848	MB687R	1004	ND109R	1010
LX225C	1060	MB248	848	MB688R	1004	ND118R	1011
LX227R	1060	MB249	848	MB689R	1004	ND120R	1011
LX228R	1060	MB250	848	MB690R	1004	ND121R	1011
LX235R	1062	MB251	848	MB691R	1004	ND122R	1011
LX237R	1062	MB252	848	MB692R	1004	ND123R	1011
LX240R	1061	MB253	848	MB693R	1004	ND124R	1011
LX241R	1061	MB254	848	MB694R	1004	ND125R	1011
LX265C	1061	MB256	848	MB750R	798		
LX266	1061	MB257	848	MB751R	798	OA200R	458
LX267R	1061	MB258	848	MB785R	404	OA218R	458
LX269R	1061	MB259	848	MB872R	987	OA225R	458
LX310R	1014, 1062	MB260	848	MB873R	987	OA310R	373
LX505R	1082	MB261	848	MB874R	987	OA311R	373
LX522C	1082	MB262	848	MB875R	987	OA312R	373
LX548R	134, 1083	MB263	848	MB876R	987	OA313R	373
LX550R	135, 1083	MB264	848	MB877R	987	OA314R	373
LX552R	135, 1083	MB265	848	MB878R	987	OA332R	360
LX553R	135, 1083	MB275R	930	MB879R	987	OA333R	360
LX556R	135, 1084	MB276R	930	MB880R	987	OA334R	360
LX558R	135, 1084	MB277R	930			OA335R	360
LX565R	134, 1084	MB278R	930	MD076	428	OA336R	360
LX574R	1085	MB279R	971	MD077	428	OA337R	360



Numerischer Index – Numerical Index

OA – OM

Art. Nr. Cat. No.	Seite Page	Art. Nr. Cat. No.	Seite Page	Art. Nr. Cat. No.	Seite Page	Art. Nr. Cat. No.	Seite Page
OA338R	360	OF261R	348	OK741R	893	OL343R	999
OA340R	373	OF262R	348	OK742R	893	OL401R	978
OA351R	362	OF282R	356	OK745R	894	OL403R	978
OA357R	356	OF283R	356	OK794R	463	OL405R	979
OA358R	356	OF284R	356	OK795R	463	OL406R	979
OA359R	356	OF285R	356	OK900	598	OL407R	978
		OF288R	356			OL408R	978
OB510	347	OF760R	892	OL011R	165	OL409R	978
OB511	347	OF768R	892	OL102R	32	OL410R	978
OB512	347			OL104R	32	OL411R	978
OB513	347	OG164R	962	OL114R	32	OL412R	978
OB514	347	OG165R	962	OL155R	965	OL421R	979
		OG950R	1098	OL157R	969	OL423R	979
OC020R	152	OG951R	1098	OL160R	849, 963	OL425R	979
OC021R	152	OG960R	1098	OL162R	963	OL427R	979
OC022R	152	OG961R	1098	OL163R	963	OL429R	979
OC024R	171	OG962R	1098	OL164R	964	OL601R	361
OC025R	171	OG963R	1098	OL165R	849, 965	OL602R	361
OC026R	171	OG964R	1098	OL166R	965	OL603R	361
OC051R	168	OG969R	1098	OL168R	1103	OL610R	361
OC069R	151	OG970R	1098	OL170R	964	OL611R	362
OC091R	168	OG971R	1098	OL171R	964	OL612R	362
OC094R	168	OG972R	1098	OL177R	1103	OL614R	363
OC100R	170	OG973R	1098	OL179R	965	OL615R	361
OC415R	76	OG974R	1098	OL187R	1101	OL616R	361
OC430R	77			OL189R	515	OL617R	361
OC461R	49	OK093R	570	OL192R	960	OL619R	361
OC480R	48	OK365R	77	OL195R	1103	OL620R	362
OC482R	48	OK366R	78	OL196R	1103	OL621R	361
OC485R	48	OK367R	77	OL198R	963	OL622R	362
OC486R	48	OK368R	77	OL201R	372	OL623R	362
OC491R	49	OK369R	77	OL202R	370	OL624R	362
OC492R	49	OK372R	77	OL206R	363	OL626R	361
OC496R	49	OK373R	77	OL207R	363	OL627R	361
OC497R	49	OK374R	76	OL211R	373	OL652R	33
OC498R	48	OK378R	1038	OL212R	373	OL653R	33
OC499R	48	OK503R	900	OL219R	383	OL654R	33
OC500R	48	OK505R	899	OL220R	383	OL656R	33
		OK506R	899	OL221R	385	OL657R	33
OF001N	6	OK507R	899	OL294R	1001	OL670R	33
OF002N	6	OK508R	899	OL296R	1001		
OF003N	6	OK509R	899	OL298R	1001	OM010	14
OF004N	6	OK520R	899	OL299R	1001	OM015R	14
OF005N	6	OK521R	899	OL300R	1001	OM030R	14
OF006N	6	OK522R	899	OL301R	1001	OM044R	14
OF010N	6	OK525R	901	OL302R	1001	OM047R	15
OF031N	6	OK526R	901	OL303R	1001	OM048R	15
OF033N	6	OK536R	900	OL304R	1001	OM049R	15
OF090	2	OK537R	900	OL307R	1001	OM078R	5
OF237	1099	OK538R	901	OL311R	998	OM079R	5
OF238	1100	OK711R	892	OL314R	998	OM080R	5
OF239	1100	OK712R	892	OL316R	998	OM081R	5
OF257R	348	OK737R	894	OL341R	999	OM082R	5
OF259R	348	OK740R	893	OL342R	999	OM083R	5

Numerischer Index – Numerical Index

OM – XF

9
0

Art. Nr. Cat. No.	Seite Page	Art. Nr. Cat. No.	Seite Page	Art. Nr. Cat. No.	Seite Page	Art. Nr. Cat. No.	Seite Page
OM084R	5	SF835	587				
OM085R	5	SF836	587				
OM086R	5						
OM087R	5	SR421R	855				
OM088R	5	SR428R	634				
OM089R	5	SR580R	721				
OM090R	5						
OM202R	4, 348	TE749R	478, 479				
OM203R	4						
OM205R	4	US100	489				
OM208R	4	US100201	489				
OM251R	378	US100202	489				
OM252R	378						
OM253R	378	VC100R	584				
OM307R	930	VC101R	584				
OM308R	930						
OM309R	960	XF830	533				
OM311R	961						
OM314R	961						
OM315R	961						
OM485R	185						
OM487R	351						
OM488	347						
OM489R	68						
OM602R	197, 678						
OM670R	1103						
OM671R	1094						
OM672R	1101						
OM680R	31						
OM681R	31						
OP030R	1102						
OP031R	1102						
OP130R	116						
OP151R	581, 704, 705						
OP152R	705						
OP160R	705						
OP161R	705						
OP222R	705						
OP223R	705						
OP230R	705						
OP360R	1102						
OP361R	1102						
OP362R	1102						
OP801	576						
PL561T	744						
PL565T	738						
PL566T	738						
PL567T	740						
PL568T	742						
SF462	587						
SF818R	587						



AESCULAP®

B | BRAUN
SHARING EXPERTISE

Aesculap AG

Am Aesculap-Platz
78532 Tuttlingen
Germany

Phone +49 7461 95-0
Fax +49 7461 95-2600

www.aesculap.de

All rights reserved. Technical alterations are possible. This leaflet may be used for no other purposes than offering, buying and selling of our products. No part may be copied or reproduced in any form. In the case of misuse we retain the rights to recall our catalogs and pricelists and to take legal actions.