

**RIGHT SIDE COMPARTMENTS CONTAIN THE FOLLOWING:**

COMPARTMENT RS1 CONTAINS:  
 - (3) SHELVES, ADJUSTABLE, 500LB CAP, STANDARD DEPTH COMPT

COMPARTMENT RS2 CONTAINS:  
 - (1) TRAY, SLIDE OUT, TILT 30°, 1/2 DEPTH OF TRANSVERSE COMPT, 200+ CAPACITY

COMPARTMENT RS4 CONTAINS:  
 - (2) TRAY, SLIDE OUT, TWO WAY, TRANSVERSE COMPT, ADJUSTABLE HEIGHT, 500LB CAPACITY

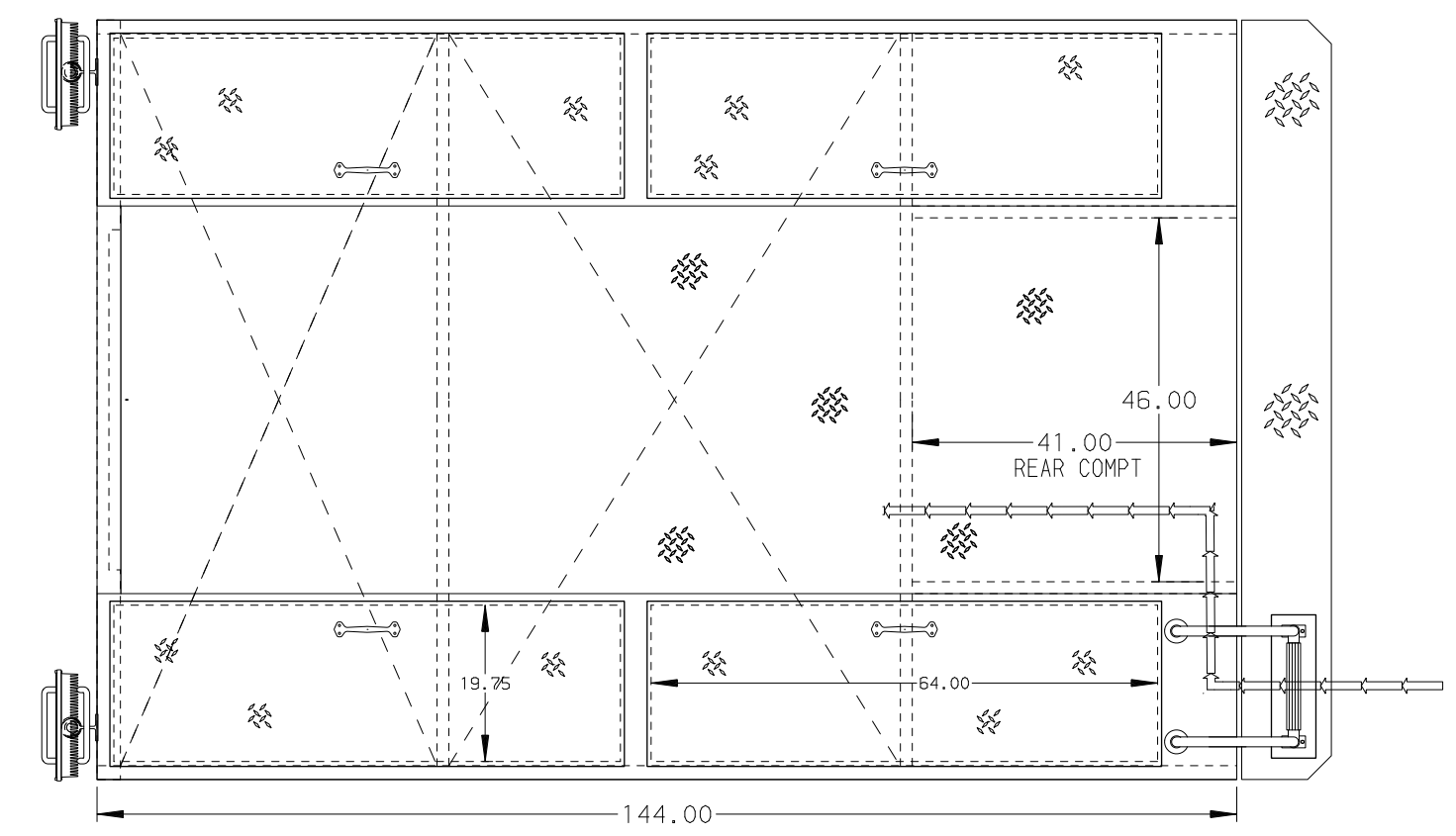
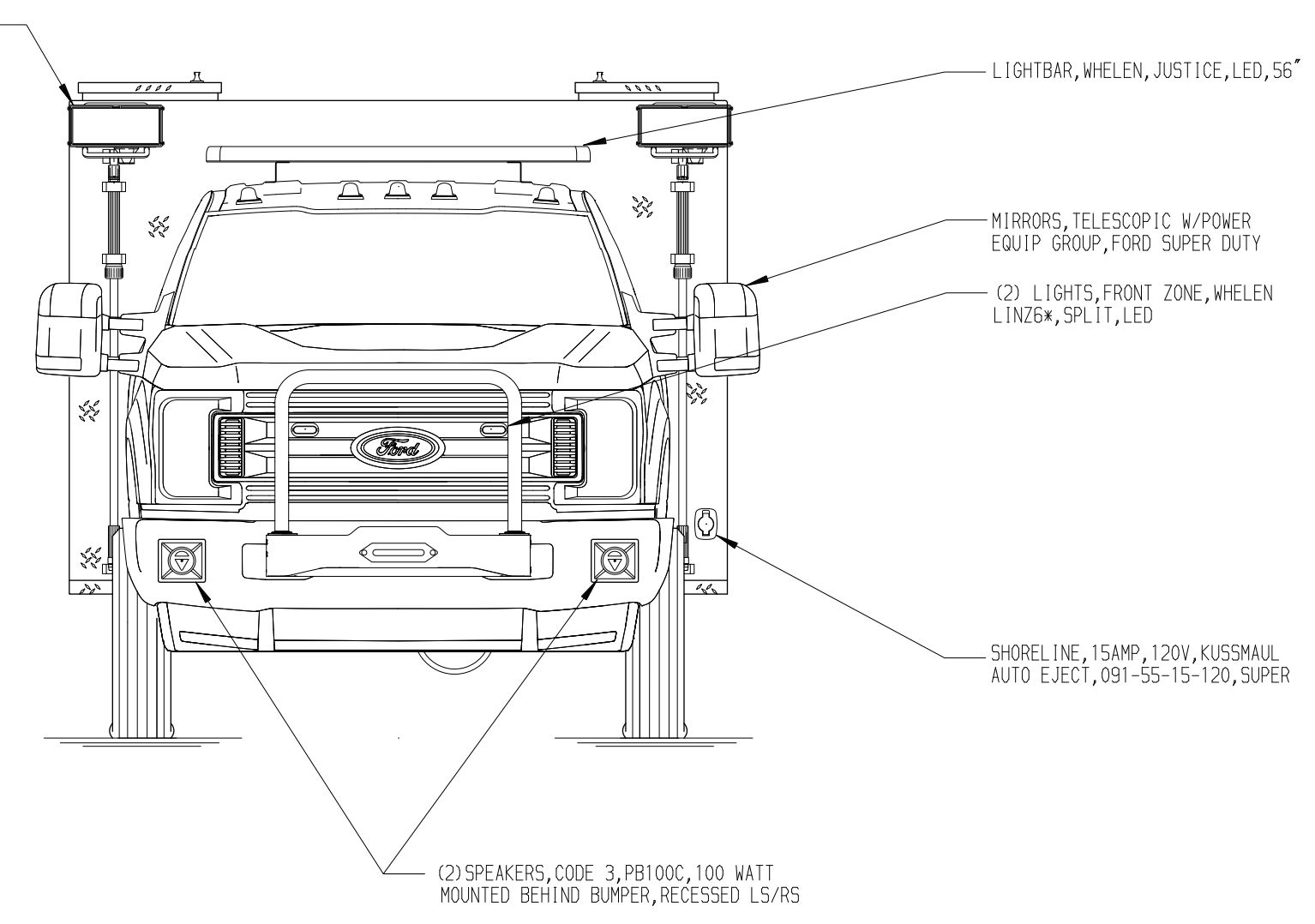
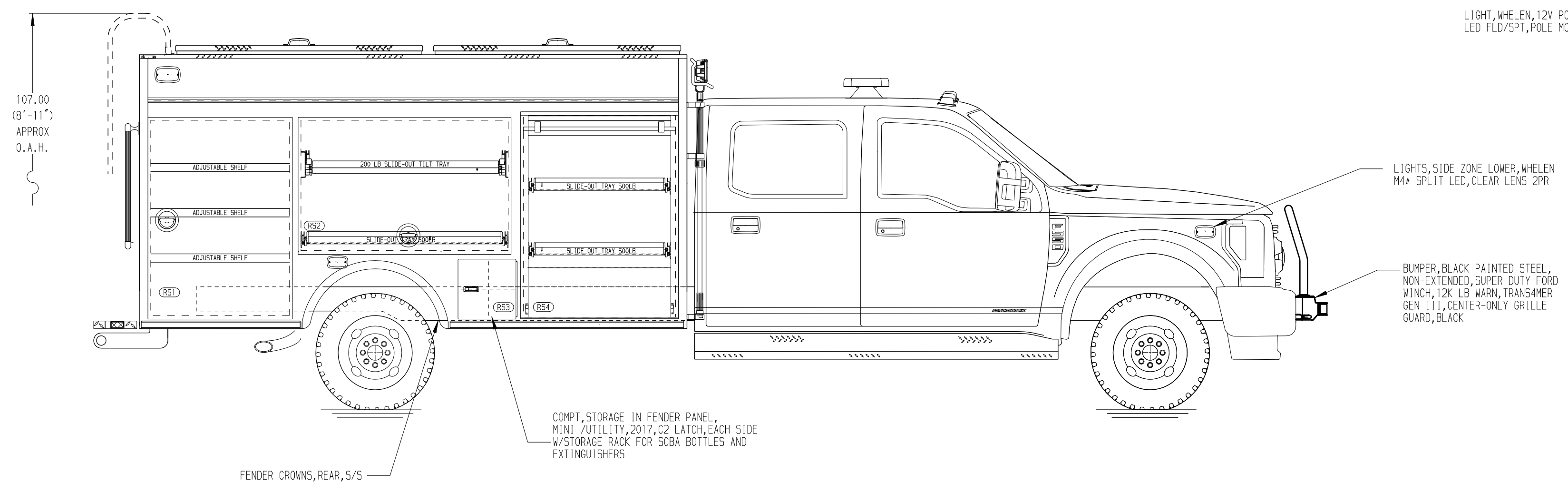

**REAR COMPARTMENT B1 CONTAINS THE FOLLOWING:**

- (1) TRAY, FLOOR MOUNTED, SLIDE-OUT, 500 LBS, 2 SIDES

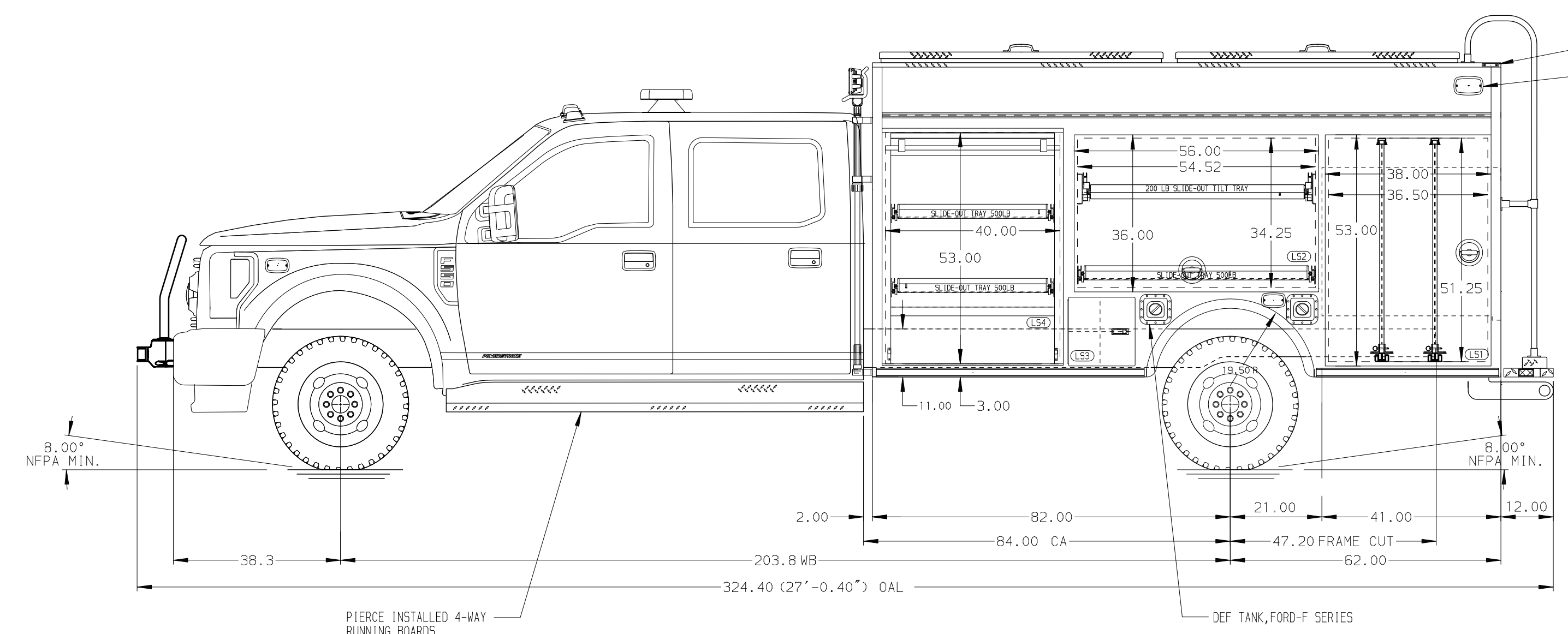

**LEFT SIDE COMPARTMENTS CONTAIN THE FOLLOWING:**

COMPARTMENT LS1 CONTAINS:  
 - (2) TOOLBOARDS, SLIDE-OUT, STD DEPTH W/GEN. DEVICE TRACK

COMPARTMENT LS2 CONTAINS:  
 - (1) TRAY, SLIDE OUT, TILT 30°, 1/2 DEPTH OF TRANSVERSE COMPT, 200+ CAPACITY

COMPARTMENT LS4 CONTAINS:  
 - (2) TRAY, SLIDE OUT, TWO WAY, TRANSVERSE COMPT, ADJUSTABLE HEIGHT, 500LB CAPACITY

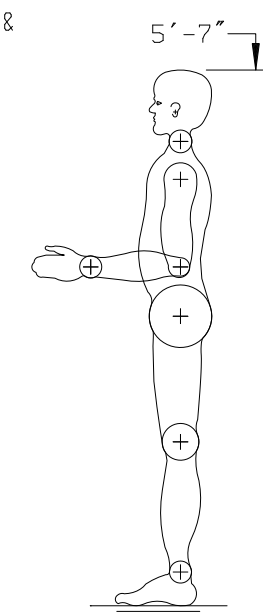
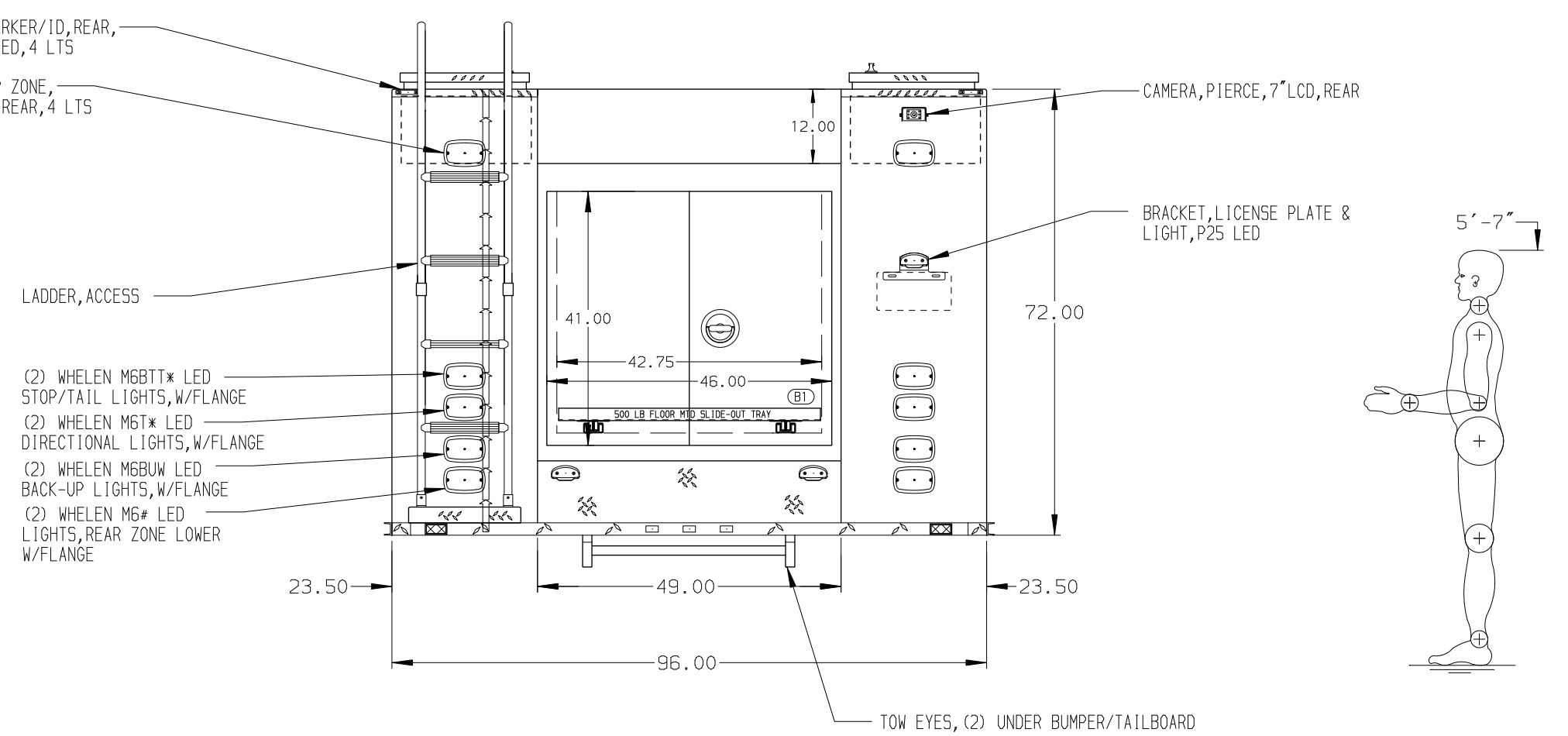

ALUMINUM BODY

**NOTE**  
 DIMENSIONS SHOWN ARE APPROXIMATE AND ARE SUBJECT TO MINOR DEVIATIONS AS MAY OCCUR OR BE NECESSARY IN CONSTRUCTION. MINOR DETAILS NOT SHOWN.

 <b>PIERCE MANUFACTURING INC.</b> BRADENTON, FLORIDA		JOB NO.	35672
		DATE	13NOV20
TITLE	12' RESCUE, NON-WALK-IN	SCALE	1:24
FOR	HARRIS COUNTY FIRE MARSHAL OFFICE HOUSTON, TEXAS	DRAWN BY	JLA
REV.	DATE	BY	CHK'D
13JAN21	18JAN21	20APR21	26FEB21
JLA	RWI	RHU	JLA
RWI	RWI	AJA	AJA
MODEL	F-550	CHASSIS	FORD
DRWG. NO.	35672AD	CHASSIS DATA	4X4
SHEET NO.	1 OF 1	SHEET SIZE	D